

10 9 8 7 6 5 4 3 2 1

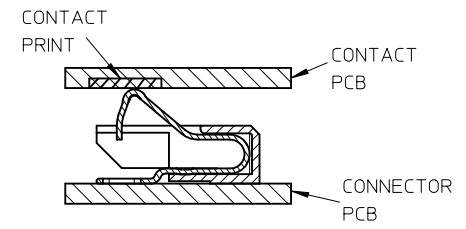

SECTION X-X

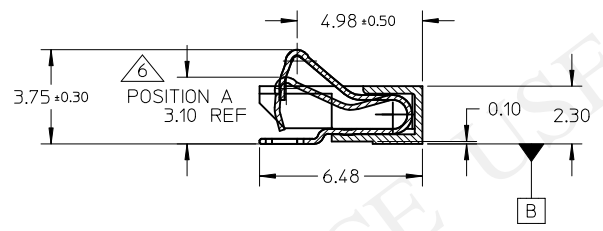
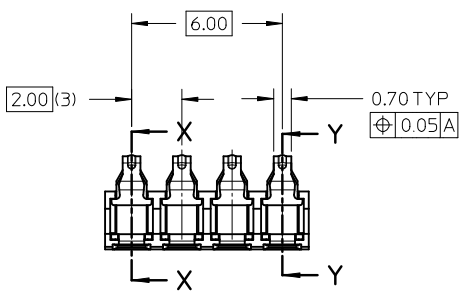
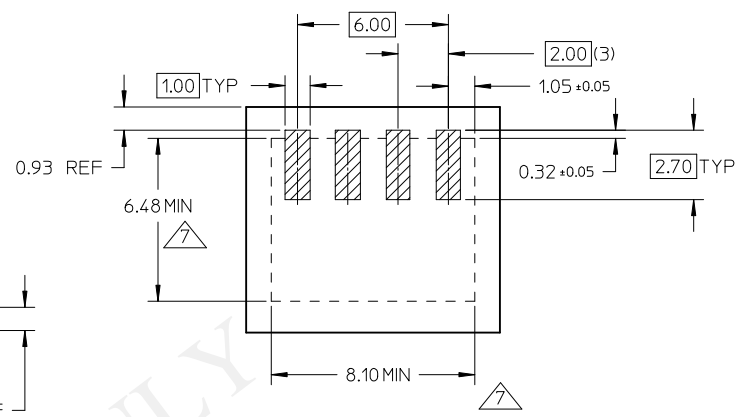
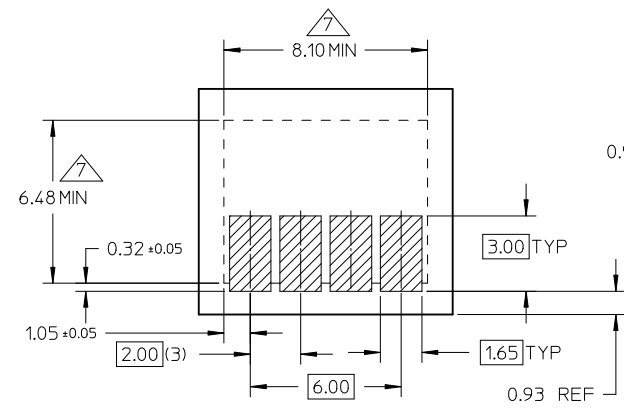
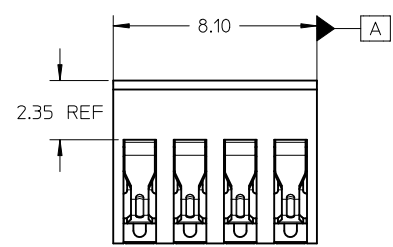
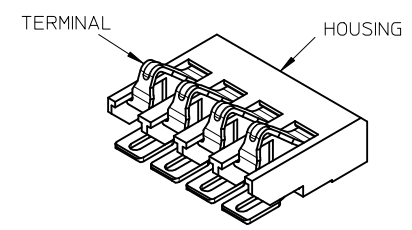
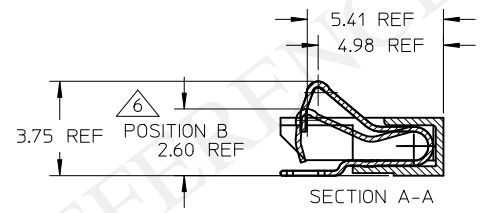
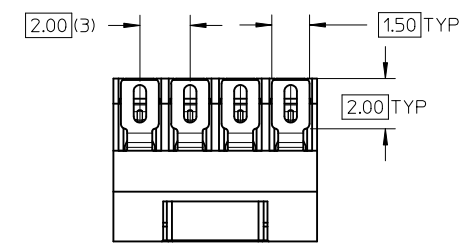

NOTE:  
 1.MATERIAL:  
 HOUSING: LCP, 30% GLASS-FILLED, UL 94V-0, COLOR :BLACK  
 TERMINAL: 0.20MM PHOSPHOR BRONZE.  
 2.FINISH:  
 CONTACT AREA: 0.75 MICRON GOLD MIN OVER 1.25 MICRON NICKEL MIN.  
 SOLDER AREA: 3.75 MICRON PURE TIN MIN OVER 1.25 MICRON NICKEL  
 MIN.REST AREA: 1.25 MICRON NICKEL MIN.  
 3.COPLANARITY: 0.1 MAX AMONG THESE SOLDER TAILS.  
 4.PRODUCT SPECIFICATION REFER TO PS-47103-001  
 5.PACKAGE REFER TO PK-47103-001  
 △ CONTACT NORMAL FORCE RANGE BETWEEN 50gm MIN TO 200gm MAX  
 WITHIN SPECIFIED WORKING POSITION A & B.  
 △ CONNECTOR KEEP-OUT ZONE

REVISED NOTE 6 EC NO: S2012-0715 DRWN: SHONG CHKD: APPR: SHONG 2	DESCRIPTION 2012/03/27 2012/03/28	QUALITY SYMBOLS ▽=0 ∇=0	GENERAL TOLERANCES (UNLESS SPECIFIED)	DIMENSION STYLE MM ONLY	SCALE 5:1	DESIGN UNITS METRIC	THIRD ANGLE PROJECTION	
		4 PLACES ± --- ± --- 3 PLACES ± --- ± --- 2 PLACES ± 0.15 ± --- 1 PLACE ± 0.20 ± --- ANGULAR ± 2 °	mm INCH	DRAWN BY DATE SSUN 2005/09/12	TITLE 2.0MM PITCH 4 CIRCUITS BATTERY CONNECTOR			
DRAFT WHERE APPLICABLE MUST REMAIN WITHIN DIMENSIONS			CHECKED BY DATE Y JWU 2005/09/12	APPROVED BY DATE GARY CHEN 2005/09/12	MATERIAL NO. 473270001			
			SIZE A3	MOLEX INCORPORATED DOCUMENT NO. RSD-47327-001				
			THIS DRAWING CONTAINS INFORMATION THAT IS PROPRIETARY TO MOLEX INCORPORATED AND SHOULD NOT BE USED WITHOUT WRITTEN PERMISSION					SHEET NO. 1 OF 1

9 8 7 6 5 4 3 2 1

10 9 8 7 6 5 4 3 2 1

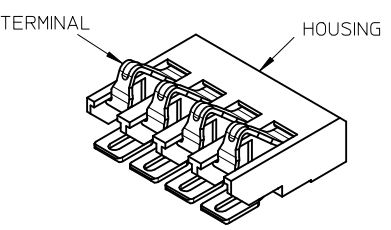
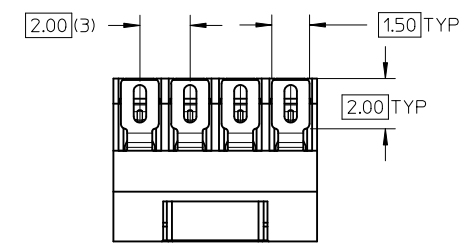
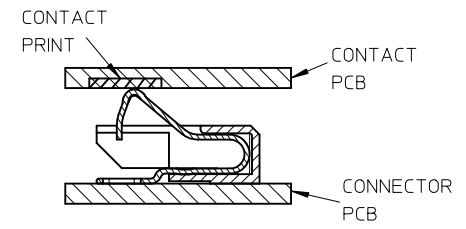
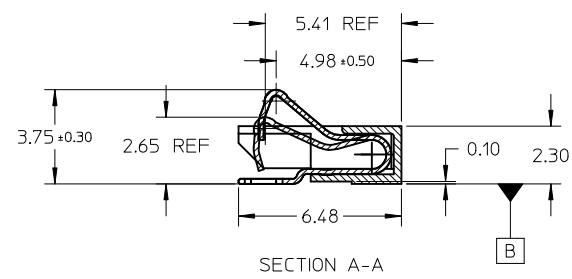
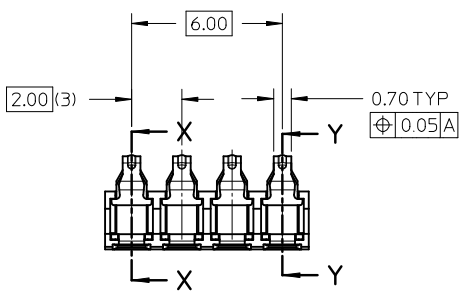
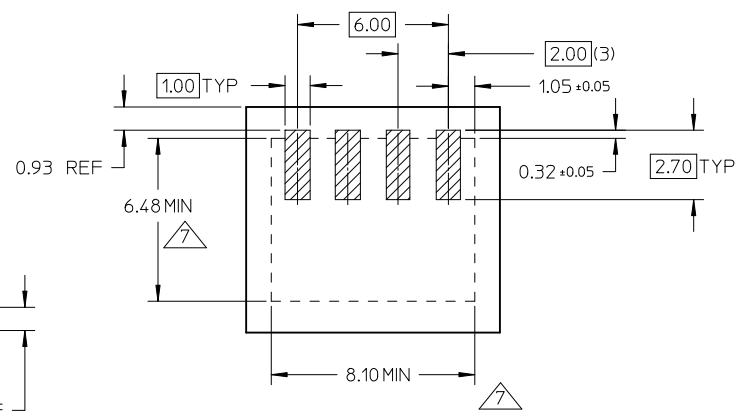
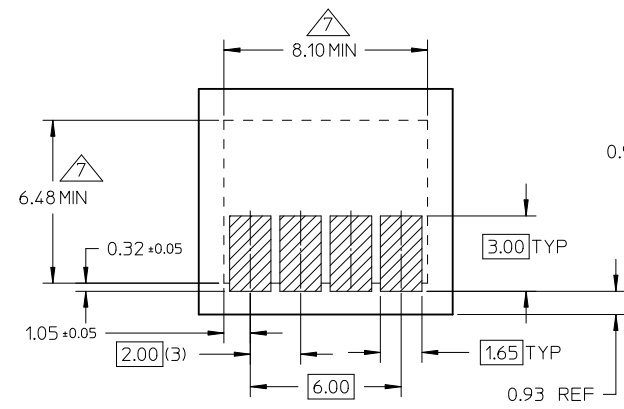
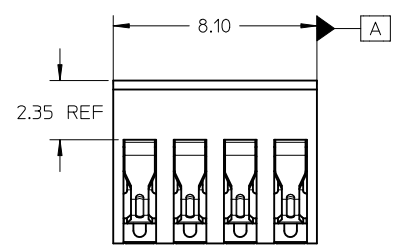

NOTE:  
 1.MATERIAL:  
 HOUSING: LCP, 30% GLASS-FILLED, UL 94V-0, COLOR :BLACK  
 TERMINAL: 0.20MM PHOSPHOR BRONZE.

2.FINISH:  
 CONTACT AREA: 0.75 MICRON GOLD MIN OVER 1.25 MICRON NICKEL MIN.  
 SOLDER AREA: 3.75 MICRON PURE TIN MIN OVER 1.25 MICRON NICKEL  
 MIN.REST AREA: 1.25 MICRON NICKEL MIN.  
 3.COPLANARITY: 0.1 MAX AMONG THESE SOLDER TAILS.  
 4.PRODUCT SPECIFICATION REFER TO PS-47103-001  
 5.PACKAGE REFER TO PK-47103-001  
 6.WORKING HEIGHT : 2.65MM REFERENCE  
 7.CONNECTOR KEEP-OUT ZONE

DRAWING UPDATE EC NO: S2012-0173 DRWN:LKCHEW 2011/09/16 CHKD:LING 2011/10/27 APPR:SHONG 2011/10/27	QUALITY SYMBOLS	GENERAL TOLERANCES (UNLESS SPECIFIED)	DIMENSION STYLE	SCALE	DESIGN UNITS	THIRD ANGLE PROJECTION														
	 	<table border="1"> <thead> <tr> <th></th> <th>mm</th> <th>INCH</th> </tr> </thead> <tbody> <tr> <td>4 PLACES</td> <td>± ---</td> <td>± ---</td> </tr> <tr> <td>3 PLACES</td> <td>± ---</td> <td>± ---</td> </tr> <tr> <td>2 PLACES</td> <td>± 0.15</td> <td>± ---</td> </tr> <tr> <td>1 PLACE</td> <td>± 0.20</td> <td>± ---</td> </tr> </tbody> </table>		mm	INCH	4 PLACES	± ---	± ---	3 PLACES	± ---	± ---	2 PLACES	± 0.15	± ---	1 PLACE	± 0.20	± ---	MM ONLY	5:1	METRIC
	mm	INCH																		
4 PLACES	± ---	± ---																		
3 PLACES	± ---	± ---																		
2 PLACES	± 0.15	± ---																		
1 PLACE	± 0.20	± ---																		

DRAFT WHERE APPLICABLE  
 MUST REMAIN  
 WITHIN DIMENSIONS

DRAWN BY	DATE	TITLE
SSUN	2005/09/12	2.0MM PITCH 4 CIRCUITS BATTERY CONNECTOR
CHECKED BY	DATE	
YJWU	2005/09/12	MOLEX INCORPORATED
APPROVED BY	DATE	
GARY CHEN	2005/09/12	DOCUMENT NO.
MATERIAL NO.	473270001	SD-47327-001
SIZE	A3	SHEET NO.
THIS DRAWING CONTAINS INFORMATION THAT IS PROPRIETARY TO MOLEX INCORPORATED AND SHOULD NOT BE USED WITHOUT WRITTEN PERMISSION		1 OF 1

9 8 7 6 5 4 3 2 1