

KTTWRCM3120UG

TWR-CM3120-EVM Tower System Platform

Rev. 2.0 — 8 May 2017

User guide

1 TWR-CM3120-EVM

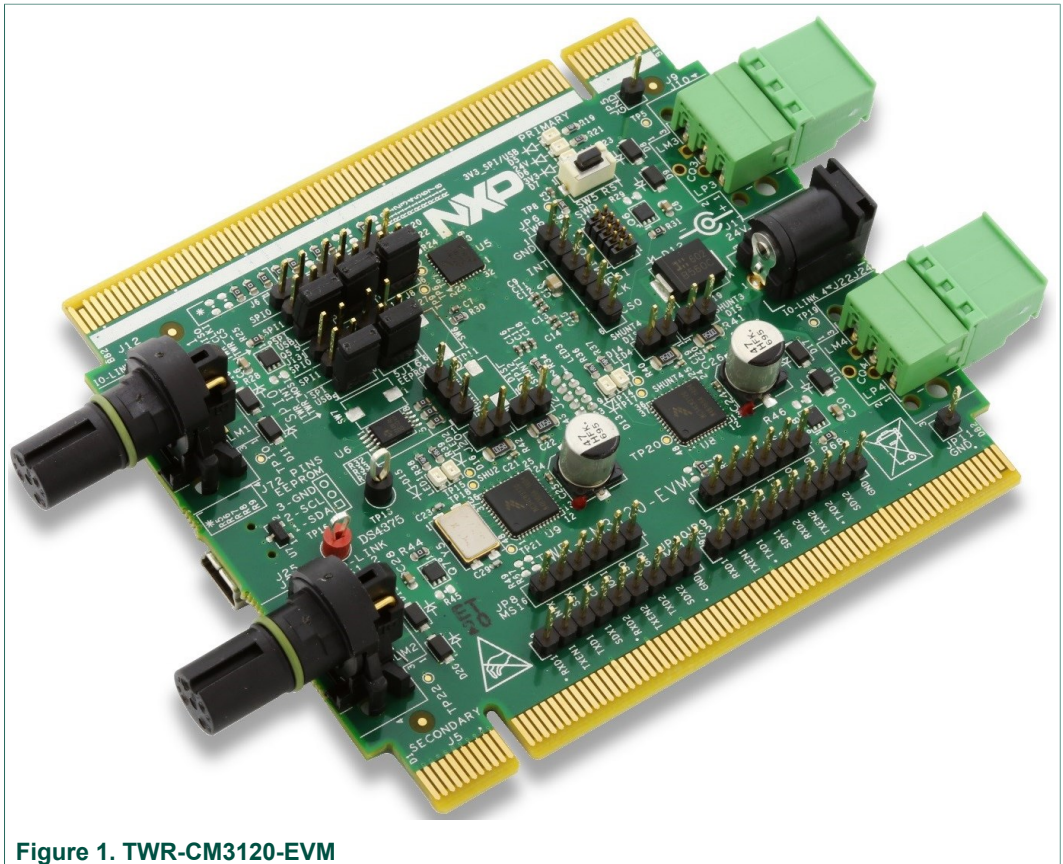

2 Important notice

NXP provides the enclosed product(s) under the following conditions:

This evaluation kit is intended for use of ENGINEERING DEVELOPMENT OR EVALUATION PURPOSES ONLY. It is provided as a sample IC pre-soldered to a printed circuit board to make it easier to access inputs, outputs, and supply terminals. This evaluation board may be used with any development system or other source of I/O signals by simply connecting it to the host MCU or computer board via off-the-shelf cables. This evaluation board is not a Reference Design and is not intended to represent a final design recommendation for any particular application. Final device in an application will be heavily dependent on proper printed circuit board layout and heat sinking design as well as attention to supply filtering, transient suppression, and I/O signal quality.

The goods provided may not be complete in terms of required design, marketing, and or manufacturing related protective considerations, including product safety measures typically found in the end product incorporating the goods. Due to the open construction of the product, it is the user's responsibility to take any and all appropriate precautions with regard to electrostatic discharge. In order to minimize risks associated with the customers applications, adequate design and operating safeguards must be provided by the customer to minimize inherent or procedural hazards. For any safety concerns, contact NXP sales and technical support services.

Should this evaluation kit not meet the specifications indicated in the kit, it may be returned within 30 days from the date of delivery and will be replaced by a new kit.

NXP reserves the right to make changes without further notice to any products herein. NXP makes no warranty, representation or guarantee regarding the suitability of its products for any particular purpose, nor does NXP assume any liability arising out of the application or use of any product or circuit, and specifically disclaims any and all liability, including without limitation consequential or incidental damages. "Typical" parameters can and do vary in different applications and actual performance may vary over time. All operating parameters, including "Typical", must be validated for each customer application by customer's technical experts.

NXP does not convey any license under its patent rights nor the rights of others. NXP products are not designed, intended, or authorized for use as components in systems intended for surgical implant into the body, or other applications intended to support or sustain life, or for any other application in which the failure of the NXP product could create a situation where personal injury or death may occur.

Should the Buyer purchase or use NXP products for any such unintended or unauthorized application, the Buyer shall indemnify and hold NXP and its officers, employees, subsidiaries, affiliates, and distributors harmless against all claims, costs, damages, and expenses, and reasonable attorney fees arising out of, directly or indirectly, any claim of personal injury or death associated with such unintended or unauthorized use, even if such claim alleges NXP was negligent regarding the design or manufacture of the part.

NXP and the NXP logo are trademarks of NXP B.V. All other product or service names are the property of their respective owners. © NXP B.V. 2017.

3 Getting started

3.1 Kit contents/packing list

The kit contents include:

- Assembled and tested TWR-CM3120-EVM tower board in an anti-static bag
- Quick Start Guide, Analog Tools
- Warranty card

3.2 Jump start

NXP's analog product development boards provide an easy-to-use platform for evaluating NXP products. The boards support a range of analog, mixed-signal and power solutions. They incorporate monolithic ICs and system-in-package devices that use proven high-volume technology. NXP products offer longer battery life, a smaller form factor, reduced component counts, lower cost and improved performance in powering state of the art systems.

1. Go to www.nxp.com/TWR-CM3120-EVM
2. Review your Tool Summary Page.
3. Locate and click:

Jump Start Your Design

4. Download the documents, software and other information.

Once the files are downloaded, review the user guide in the bundle. The user guide includes setup instructions, BOM and schematics. Jump start bundles are available on each tool summary page with the most relevant and current information. The information includes everything needed for design.

3.3 Required equipment

To use this kit, you need:

- Power supply 24 V/3.0 A
- Mini-USB cable (power for the tower logic)
- PC
- IO-Link compatible sensors/actors

3.4 System requirements

The kit requires the following:

- USB-enabled PC with Windows® 7 or higher
- NET framework 4.0 or higher

4 Understanding the Tower System

NXP's Tower System peripheral module is designed to be combined and used with other Tower System modules.

The NXP Tower System is a modular development platform for 8-, 16-, and 32-bit MCUs and MPUs, enabling advanced development through rapid prototyping. Featuring more than fifty development boards or modules, the Tower System provides designers with building blocks for entry-level to advanced MCU development.

TWR-CM3120-EVM can be associated with the TWR-K70F120M or TWR-K20D72M. Special care should be taken with the MCU board. TWR-CM3120-EVM can also work as a stand-alone board without using the rest of the tower system. In this case, the USB from PC is connected directly to the TWR-CM3120-EVM USB (placed on the bottom side). When working as a stand-alone board, the provided GUI can be used to control the IO-Link communication.

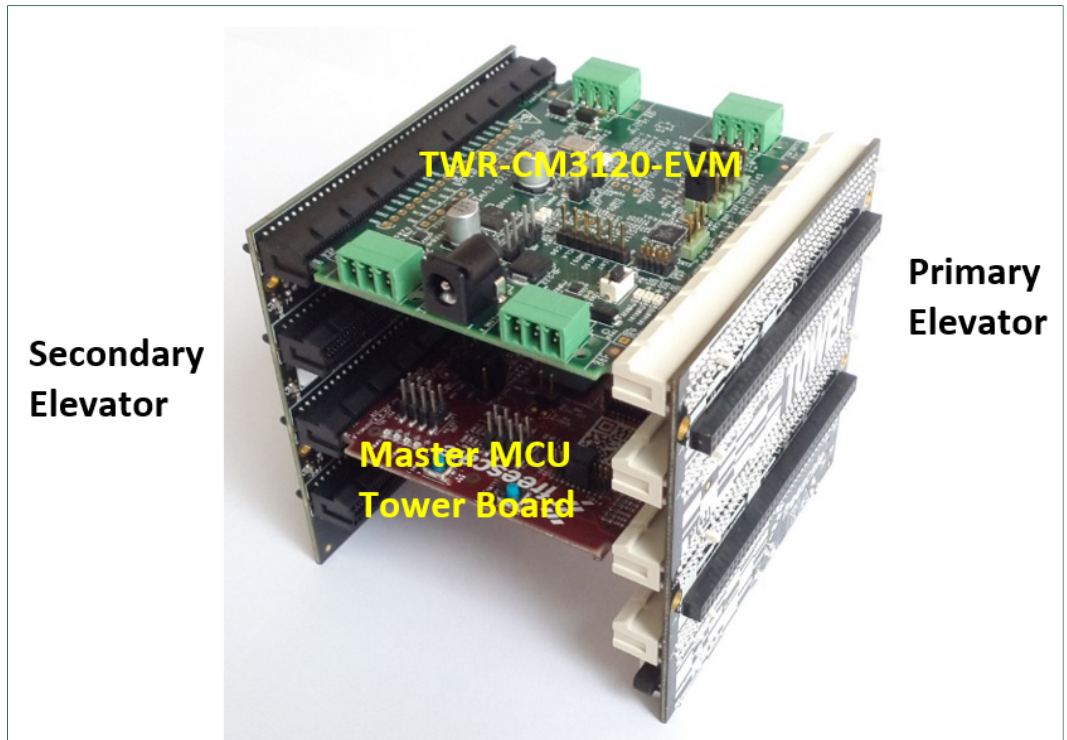

Figure 2. TWR-CM3120-EVM on Tower System

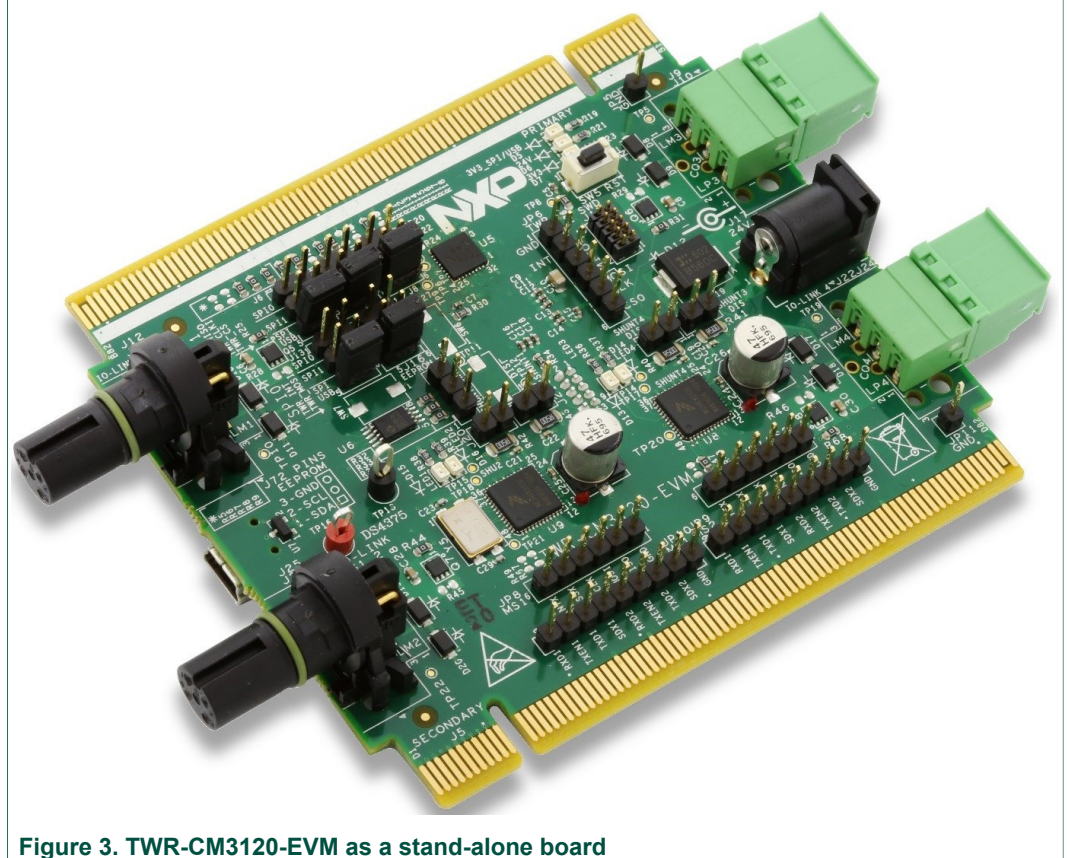

Figure 3. TWR-CM3120-EVM as a stand-alone board

5 Getting to know the hardware

5.1 Board overview

The TWR-CM3120-EVM is an easy-to-use tower peripheral module circuit board allowing the user to exercise functions for IO-Link Master Transceivers.

5.2 Board features

The hardware system features are as follows:

- Four fully featured IO-Link ports based on two CM3120 and Kinetis MKL17Z64VFM4
- On-board ESD protection
- Modular solution - stackable for multiple of four port solution
- Operating voltage range from 8.0 V to 32 V
- Optional external NMOS transistors to control current to the C/Q and L+ lines
- Four IO-Link communication status LEDs

The software system features are as follows:

- IO-Link stack loaded in the embedded MCU
- Integrated Bootloader through SPI for IO-Link stack updates
- Graphical Users Interface on PC
- Configurable through a SPI interface

5.3 Device features

The tower system feature the following NXP products:

Table 1. Device features

Device	Description	Features
MKL17Z64VFM4	Kinetis® KL1x-48 MHz, Mainstream Small Ultra-Low Power Microcontrollers (MCUs) based on ARM® Cortex®-M0+ Core	<ul style="list-style-type: none"> MCU MKL17Z64VFM4 (ARM® Cortex®-M0+ core up to 48 MHz, 64 KB program flash, 16 KB SRAM) Embedded ROM with boot loader for flexible program upgrade High accuracy internal voltage and clock reference FlexIO to support any standard and customized serial peripheral emulation Hardware CRC module Down to 46 µA/MHz in very low power run mode and 1.68 µA in stop mode (RAM + RTC retained)
MC34CM3120EP	Dual Transceiver IO-Link Master IC	<ul style="list-style-type: none"> 2 IO-Link channels with three different operation modes (SIO, UART, and frame handler) Protection mechanisms (overcurrent, overtemperature, overvoltage) Configurable through a SPI interface Operating voltage range from 8.0 V to 32 V Suitable for 2/4/8/16 port-applications Can operate as a Master or Device Two integrated LED drivers Integrated hardware frame handler (supports all IO-link v1.1 frames and COM1, COM2, and COM3 baud rates) Integrated NMOS gate drivers to control current to the C/Q and L+ lines

5.4 Block diagram

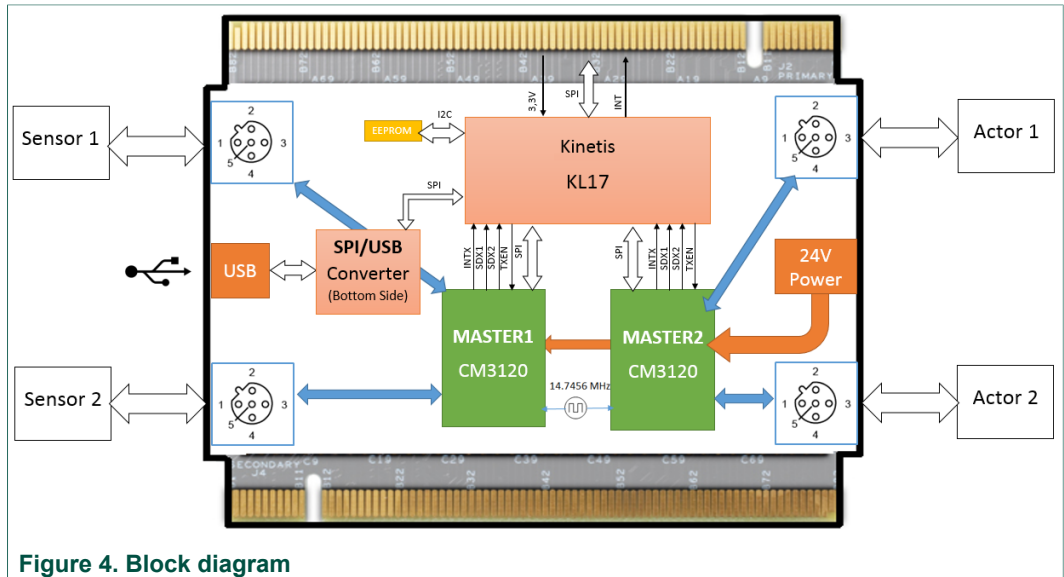
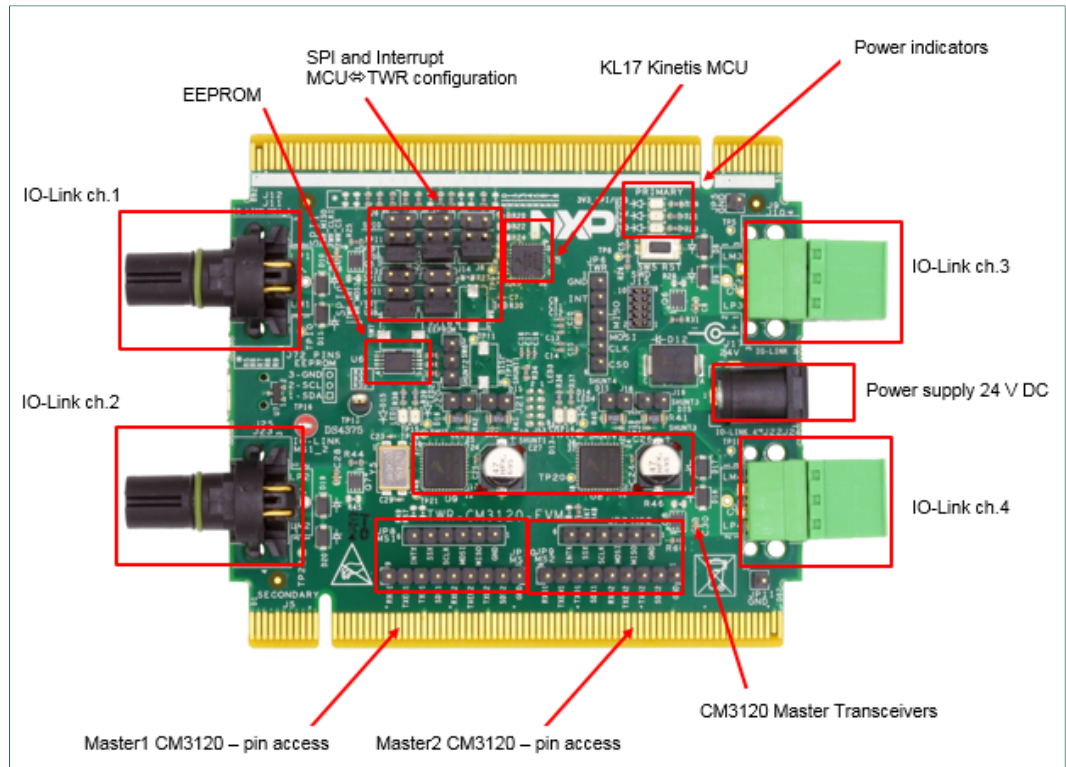

Figure 4. Block diagram

5.5 Board description

All the components that support the IO-Link functionality are placed on the top layer. Bottom layer is dedicated to SPI/USB converter that enables users to connect PC and to control IO-Link from the provided GUI.

The board includes two microcontrollers. IO-Link stack runs on Kinetis KL17 (top layer) and the SPI/USB converter on Kinetis KL25. SPI/USB converter can be bypassed by using jumpers J6, J7, J8, J13 and J14. In this case, the SPI is mapped to the standard tower elevators and an additional MCU is used to get information from the IO-Link Master stack.



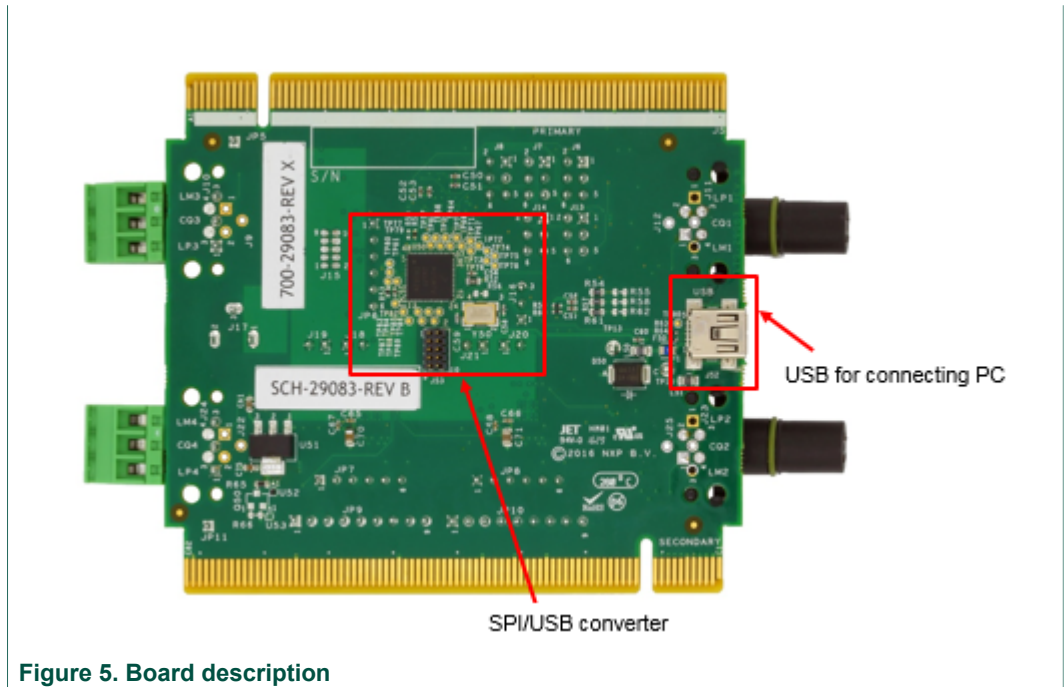

Figure 5. Board description

5.5.1 LED display

The following LEDs are provided as visual output devices for the board:

LED ID	Description
D5	Power supply indicator for SPI/USB converter
D6	24V power supply indicator
D7	3V3 power supply indicator
D13	IO-Link channel 3, communication indicator
D14	IO-Link channel 4, communication indicator
D15	IO-Link channel 1, communication indicator
D16	IO-Link channel 2, communication indicator

5.5.2 Jumper, connector and switch definitions

[Table 2](#) describes the function and settings for each jumper, connector and switch.

Table 2. Jumper, connector and switch definitions

Part reference	Pin number/pin configuration	Pin name	Description
J6	SPI bus MISO - Tower <=> KL17		
	1-2		SPI0 is used
	3-4		SPI1 is used
J8	SPI bus CS - Tower <=> KL17		
	1-2		SPI0 is used
	3-4		SPI1 is used
	5-6		On-board SPI/USB converter is used

Part reference	Pin number/pin configuration	Pin name	Description
	5-6		On-board SPI/USB converter is used
J10	1	L+	Power line (typ. +24 V)
	2	C/Q	Communication line
	3	L-	Ground
J11	1	L+	Power line (typ. +24 V)
	2	C/Q	Communication line
	3	L-	Ground
J13	Interrupt - Tower <=> KL17		
	1-2		TWR_INT1 is used
	3-4		TWR_INT2 is used
	5-6		On-board SPI/USB converter is used
J14	SPI bus MOSI - Tower <=> KL17		
	1-2		SPI0 is used
	3-4		SPI1 is used
	5-6		On-board SPI/USB converter is used
J16	EEPROM I2C bus debug connector (Do not populate with a jumper)		
	1	SDA	
	2	SCL	
	3	Ground	
J17	24 V power input		
J18	Shunt 4 bypass (populate jumper if the external sense is not used)		
J19	Shunt 3 bypass (populate jumper if the external sense is not used)		
J20	Shunt 2 bypass (populate jumper if the external sense is not used)		
J21	Shunt 1 bypass (populate jumper if the external sense is not used)		
J123	1	L+	Power line (typ. +24V)
	2	C/Q	Communication line
	3	L-	Ground
J24	1	L+	Power line (typ. +24V)
	2	C/Q	Communication line
	3	L-	Ground
J47	SPI bus CLK- Tower <=> KL17		

Part reference	Pin number/pin configuration	Pin name	Description
	1-2		SPI0 is used
	3-4		SPI1 is used
	5-6		On-board SPI/USB converter is used
J52	Mini-USB		
J54	IO-Link channel 1		
	1	L+	Power line (typ. +24 V)
	2	DI/DQ	Additional I/O
	3	L-	Ground
	4	C/Q	Communication line
J55	IO-Link channel 2		
	1	L+	Power line (typ. +24 V)
	2	DI/DQ	Additional I/O
	3	L-	Ground
	4	C/Q	Communication line
J56	IO-Link channel 4		
	1	L+	Power line (typ. +24 V)
	2	DI/DQ	Additional I/O
	3	L-	Ground
	4	C/Q	Communication line
J57	IO-Link channel 3		
	1	L+	Power line (typ. +24 V)
	2	DI/DQ	Additional I/O
	3	L-	Ground
	4	C/Q	Communication line
J59	Serial Wire Debug connector		
	1	3V3	
	2	SWD_DIO	
	3	Ground	
	4	SWD_CLK	
	5	Ground	
	6	NC	
	7	NC	
	8	NC	
	9	NC	
	10	RST_MCU	
JP5	Ground - Test point		
JP6	SPI bus and interrupt TWR <=> KL17 debug connector (Do not populate with a jumper)		
	1	Ground	
	2	INTX	

Part reference	Pin number/pin configuration	Pin name	Description
	3	MISO	
	4	MOSI	
	5	CLK	
	6	CS0	
JP7	Master 2 SPI bus debug connector (Do not populate with a jumper)		
	1	Ground	
	2	MISO	
	3	MOSI	
	4	SCLK	
	5	SSX	
	6	INTX	
JP8	Master 1 SPI bus debug connector (Do not populate with a jumper)		
	1	Ground	
	2	MISO	
	3	MOSI	
	4	SCLK	
	5	SSX	
	6	INTX	
JP9	Master 2 debug connector (Do not populate with a jumper)		
	1	Ground	
	2	SDX	
	3	TXD	
	4	TXEN	
	5	RXD	
	6	SDX	
	7	TXD	
	8	TXEN	
	9	RXD	
JP10	Master 1 debug connector (Do not populate with a jumper)		
	1	Ground	
	2	SDX	
	3	TXD	
	4	TXEN	
	5	RXD	
	6	SDX	
	7	TXD	
	8	TXEN	
	9	RXD	
JP11	Ground - Test point		

Part reference	Pin number/pin configuration	Pin name	Description
SW5	Kinetis KL17 reset		
SW6	Kinetis KL17 ROM Bootloader activation		
SW7	Kinetis KL25 Bootloader activation		
SW8	Kinetis KL25 reset		

5.5.3 Elevator connections

The board features two expansion card-edge connectors that interface to elevator boards in a Tower System: the Primary and Secondary Elevator connectors. [Table 3](#) provides the pinouts for the Primary Elevator connector. There is no connection for the Secondary Elevator connectors.

Table 3. Primary elevator connector pinouts

Top side of primary connector side B				Bottom side of primary connector side A			
Pin #	Name	Group	Usage	Pin #	Name	Group	Usage
B1	5V	Power	5.0V Power	A1	5V	Power	5.0V Power
B2	GND	Power	Ground	A2	GND	Power	Ground
B3	3.3V	Power	3.3V Power	A3	3.3V	Power	3.3V Power
B4	NC			A4	3.3V	Power	3.3V Power
B5	GND	Power	Ground	A5	GND	Power	Ground
B6	GND	Power	Ground	A6	GND	Power	Ground
B7	SPI1_CLK	SPI 1		A7			
B8	SPI1_CS1	SPI 1		A8			
B9	SPI1_CS0	SPI 1		A9			
B10	SPI1_MOSI	SPI 1		A10			
B11	SPI1_MISO	SPI 1		A11			
Mechanical key							
B12	NC			A12			
B13	NC			A13			
B14	NC			A14			
B15	NC			A15			
B16	NC			A16			
B17	NC			A17			
B18	NC			A18			
B19	NC			A19			
B20	NC			A20			
B21	NC		20_IN0	A21			
B22	NC		06_IN1	A22			
B23	NC			A23			
B24	NC			A24			
B25	NC			A25			

Top side of primary connector side B				Bottom side of primary connector side A			
Pin #	Name	Group	Usage	Pin #	Name	Group	Usage
B26	GND	Power	Ground	A26	GND	Power	Ground
B27				A27			
B28				A28			
B29				A29			
B30				A30			
B31	GND	Power	Ground	A31	GND	Power	Ground
B32				A32			
B33				A33			
B34				A34			
B35				A35			
B36	3.3V	Power	3.3V Power	A36	3.3V	Power	3.3V Power
B37				A37			
B38				A38			
B39				A39			
B40				A40			
B41				A41			
B42				A42			
B43				A43			
B44	SPI0_MISO	SPI 0	MISO	A44			
B45	SPI0_MOSI	SPI 0	MOSI	A45			
B46	SPI0_CS0	SPI 0		A46			
B47	SPI0_CS1	SPI 0		A47			
B48	SPI0_CLK	SPI 0	CLK	A48			
B49	GND	Power	Ground	A49	GND	Power	Ground
B50		I2C 1		A50			
B51		I2C 1		A51			
B52		GPIO/SPI 0	50_IN0 ^[1]	A52			
B53		USB 0		A53			
B54		USB 0		A54			
B55		Interrupt		A55			
B56	IRQ_G	Interrupt		A56			
B57		Interrupt	06_FSB	A57			
B58	IRQ_E	Interrupt		A58			
B59		Interrupt	06_FSB	A59			
B60	IRQ_C	Interrupt		A60			
B61		Interrupt		A61			
B62	IRQ_A	Interrupt	06_SYNC	A62			
B63		EBI		A63			
B64		EBI		A64			
B65	GND	Power	Ground	A65	GND	Power	Ground

Top side of primary connector side B				Bottom side of primary connector side A			
Pin #	Name	Group	Usage	Pin #	Name	Group	Usage
B66		EBI		A66			
B67				A67			
B68				A68			
B69				A69			
B70				A70			
B71				A71			
B72				A72			
B73				A73			
B74				A74			
B75				A75			
B76				A76			
B77				A77			
B78				A78			
B79				A79			
B80				A80			
B81	GND	Power	Ground	A81	GND	Power	Ground
B82	3.3V	Power	3.3V Power	A82	3.3V	Power	3.3V Power

[1] The 50_IN1 is not available.

5.6 Installing the software and setting up the hardware

5.6.1 Setting up the hardware

Follow the instructions to setup the demo properly:

1. To use the on-board SPI/USB converter, some jumpers are configured as shown in [Table 4](#).
2. Connect IO-Link compatible sensor/actor to one of the four IO-Link ports (J11/J54, J23/J55, J10/J57 or J24/J56).
3. Plug 24 V DC power supply to the J17 on the TWR-CM3120-EVM (positive pin is in the center).
4. Connect J52 (placed on the bottom side) to the PC using a mini-USB cable
5. Launch the Graphical User Interface on the PC (see [Section 5.6.2 "Installing the software"](#) for details).

Table 4. Jumper configuration

Jumper	Jumper configuration
J6	5-6
J7	5-6
J8	5-6
J13	5-6
J14	5-6

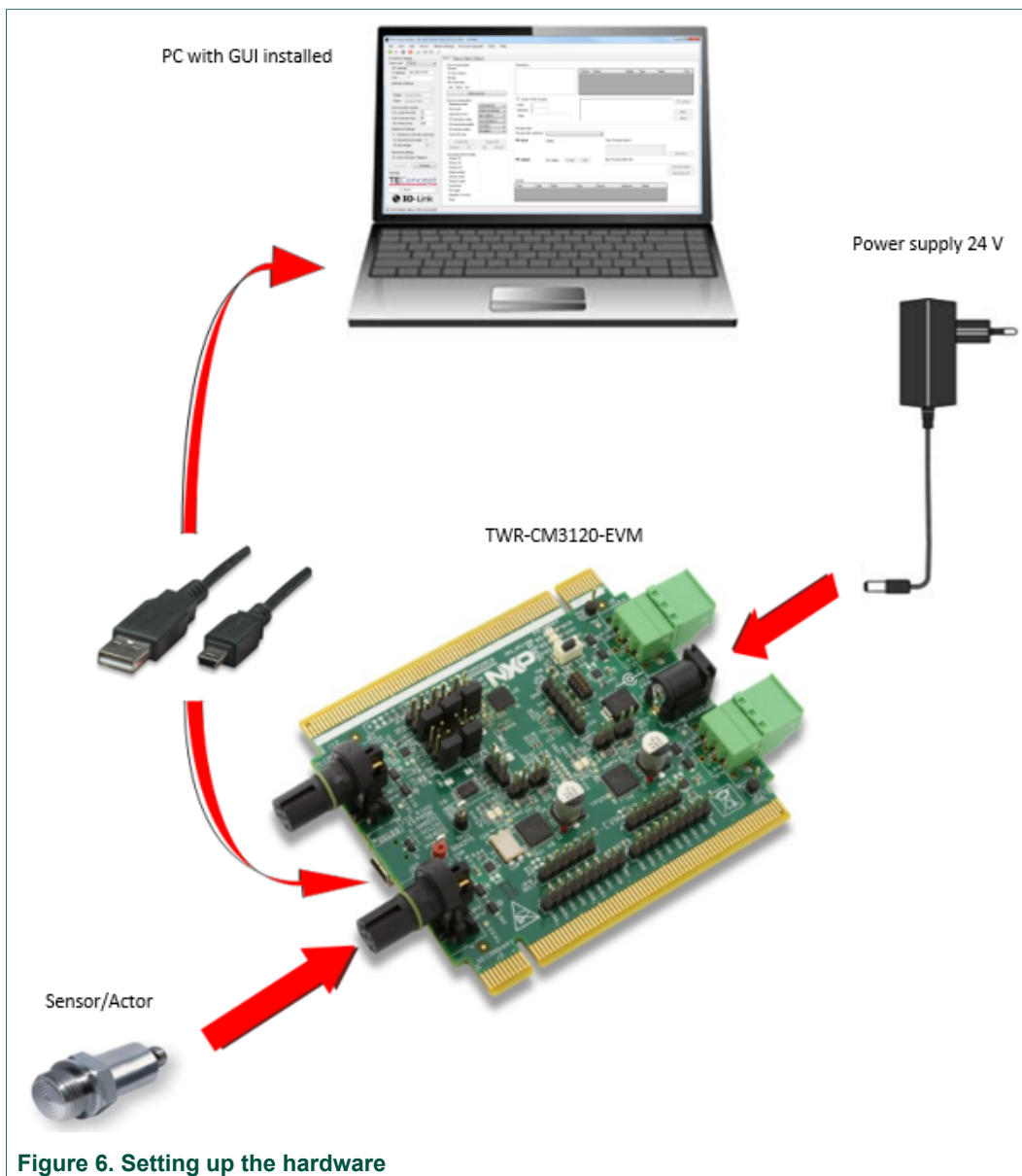

Figure 6. Setting up the hardware

5.6.2 Installing the software

5.6.2.1 Installing USB driver

USB driver is compatible with Windows operating systems (Windows 7 and higher).

1. To install the driver, launch "setup.exe" and follow the instructions.

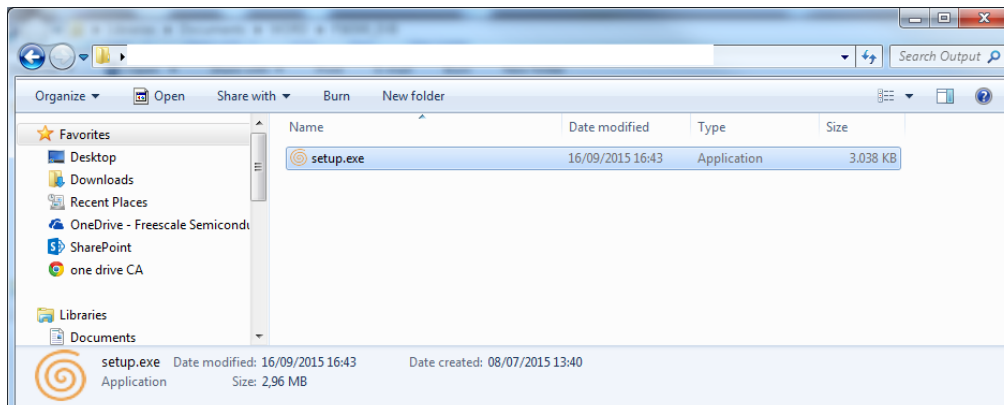

2. Connect HW to your PC and wait for its installation. When the hardware is installed properly, the following screen is displayed.

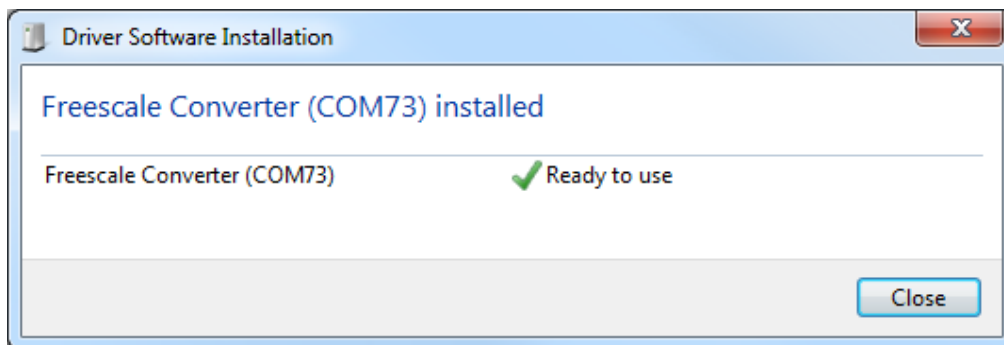

Note:

Provided driver is not signed by Microsoft, so it cannot be installed on machines where the signature is mandatory. On Windows 7, the user has a possibility during the installation process to omit this signature (necessary for proper installation). On Windows 8, the user has no choice during installation process and the signature is requested (default Windows 8 configuration). This setting on Windows 8 can be changed in advanced options (for details, see the Windows 8 driver installation troubleshooting).

Important:

Do not launch the Control tool before the hardware is connected and installed correctly.

5.6.2.2 Installing control tool

1. Launch the "TC_Installer.msi"
2. Follow the instructions.
3. If everything goes well, the installation completes in few seconds with the following window:

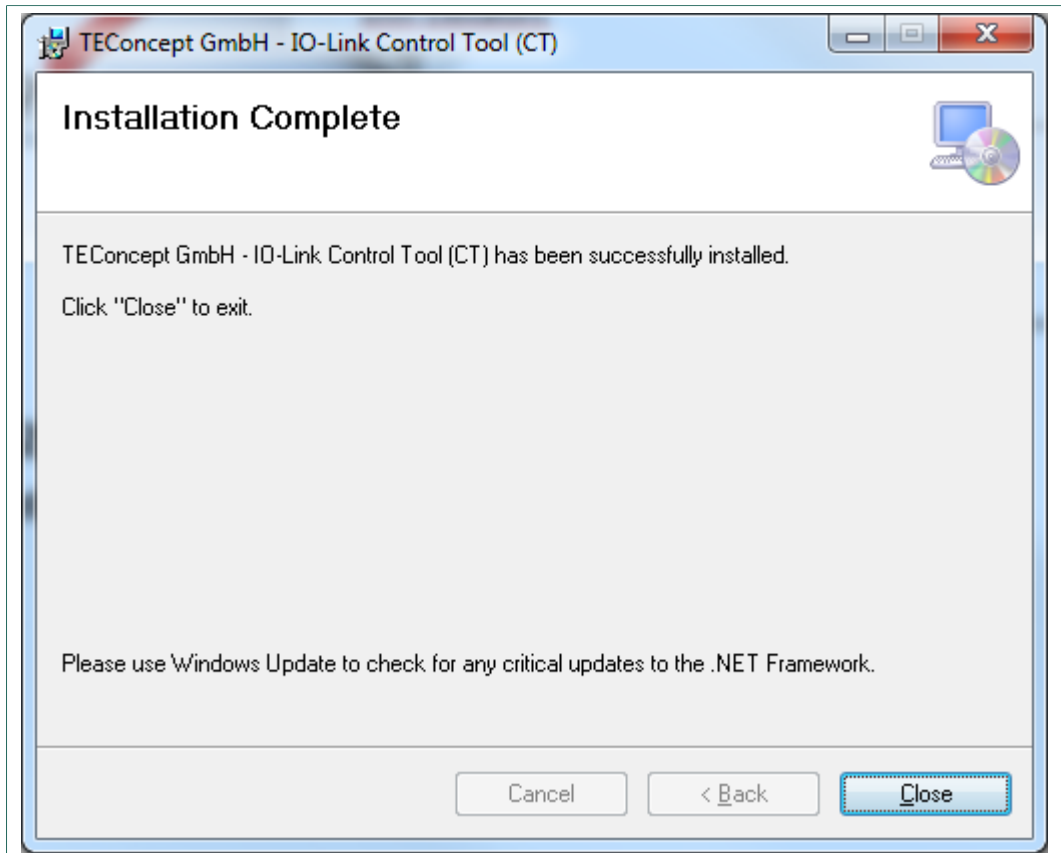

Figure 7. Installation complete

5.6.2.3 Working with the control tool

After successful installation, connect the hardware as described in [Section 5.6.1 "Setting up the hardware"](#). Launch the GUI from the Start menu:

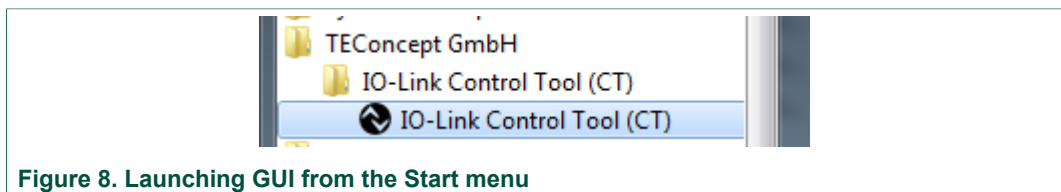
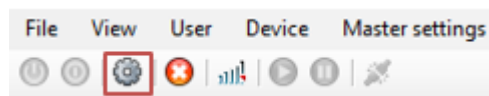

Figure 8. Launching GUI from the Start menu

To setup the control tool with the TWR-CM3120-EVM properly, follow these instructions.

1. Choose the Master:
Master settings -> Add Master -> 4 port Master
2. Choose interface:
 - a. Click **Connection settings**.



- b. Select SPI/USB interface (Freescale Converter) and click **Connect**.

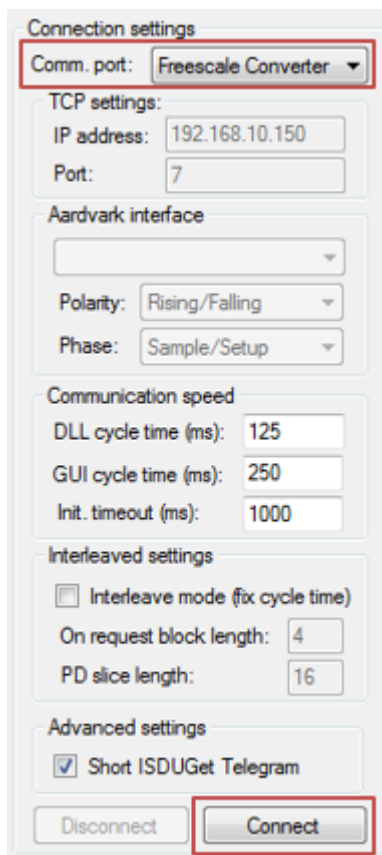

3. If the connection to the Master device is successful, the status bar on the bottom of the main window shows **Connected at**.

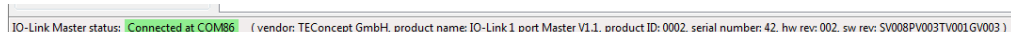

4. When the connection is established, the control window appears.

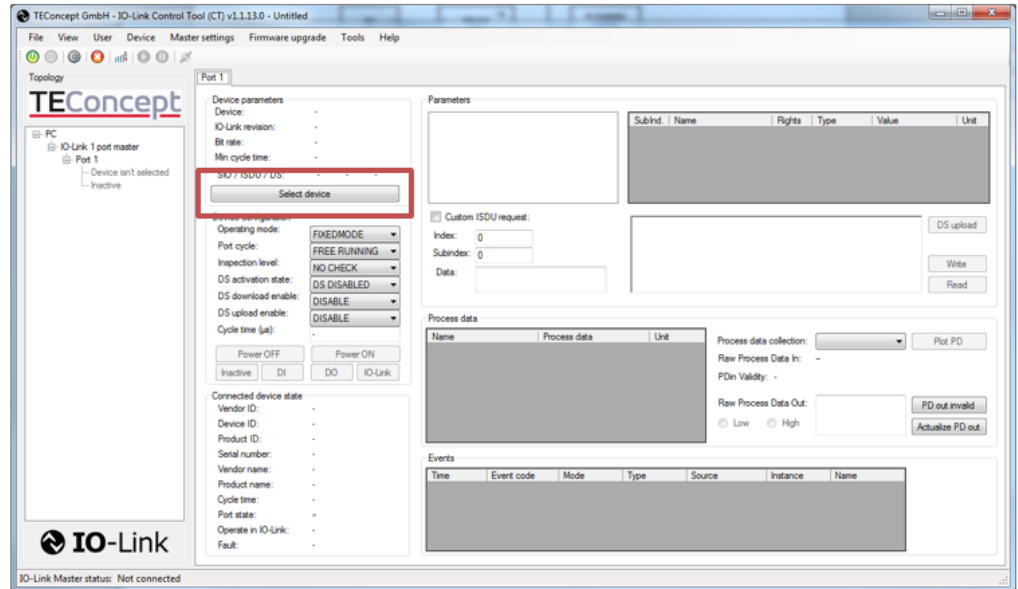

5. Select your device by clicking **Select device**.
6. Import IODD description file of your device.
 - Click **Import**.
 - Select the right IODD file.
7. Select the imported IODD file and click **Select device**.

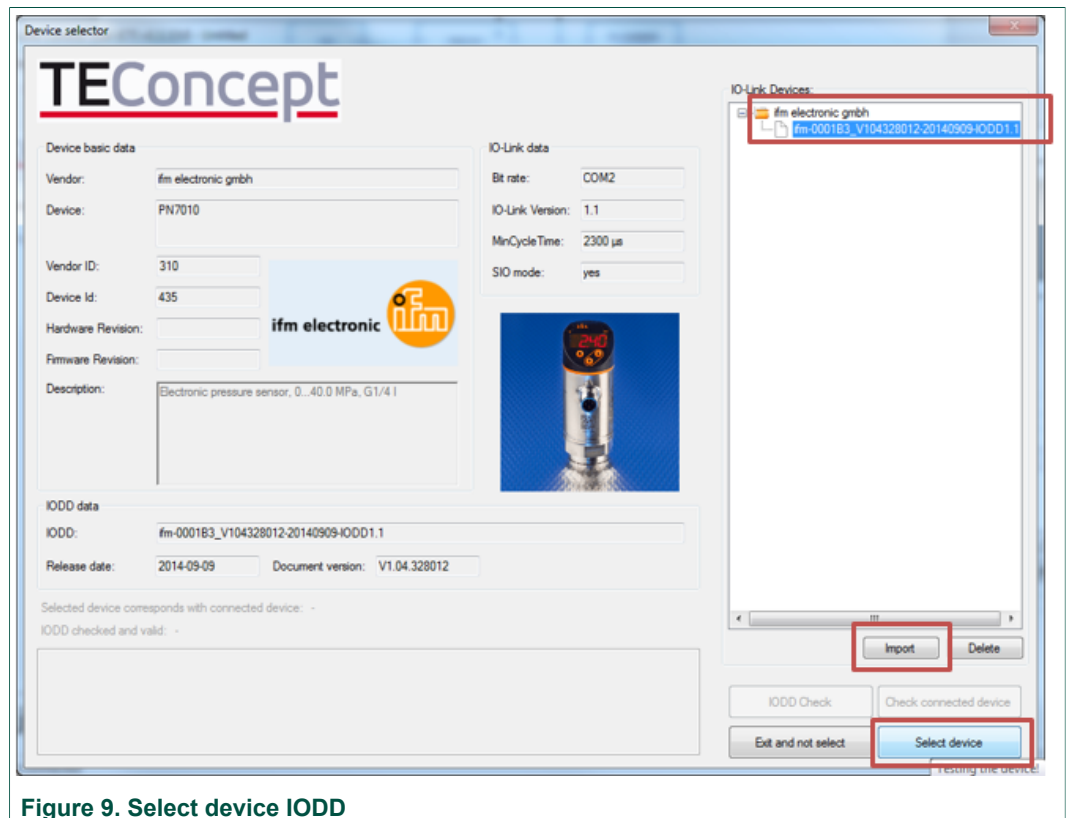

Figure 9. Select device IODD

Now the sensor is successfully connected and ready to be used.

5.6.2.4 Read basic data through IO-link

The following instructions guide the user how to read basic data through the IO-link:

1. Try to switch the sensor ON and OFF.
 - Click **Power OFF** (sensor must switch OFF completely).
 - Click **Power ON** (sensor must switch ON).
2. Establish IO-Link communication with the sensor (click **IO-Link**).

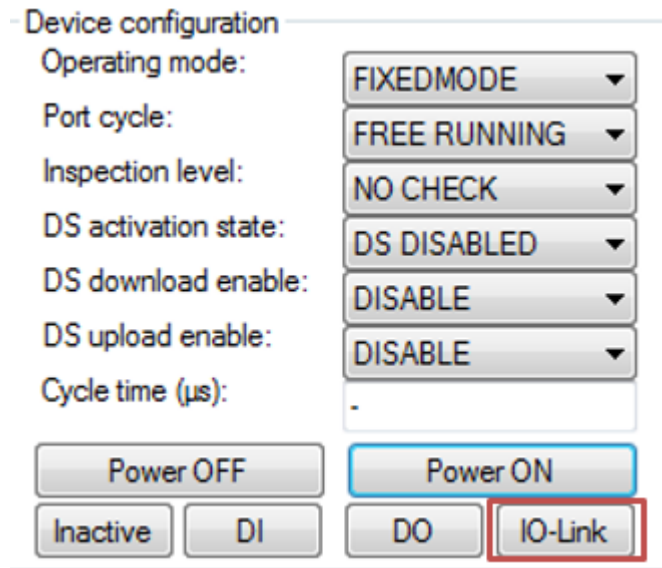

3. The sensor parameters appear.

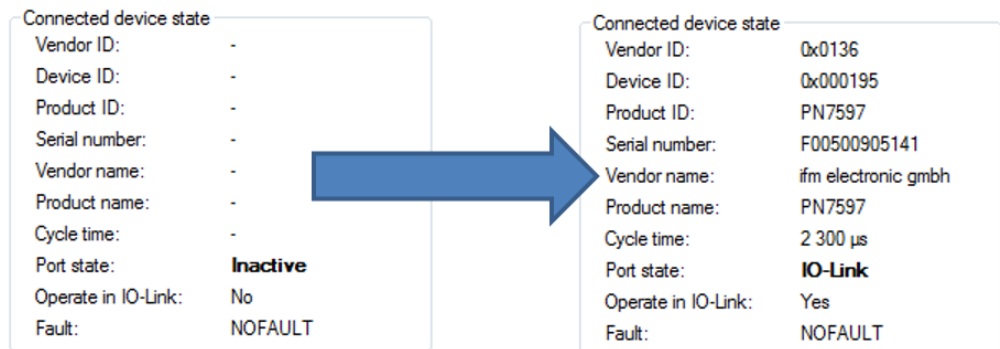

5.6.2.5 Interface description

5.6.2.5.1 Device parameters

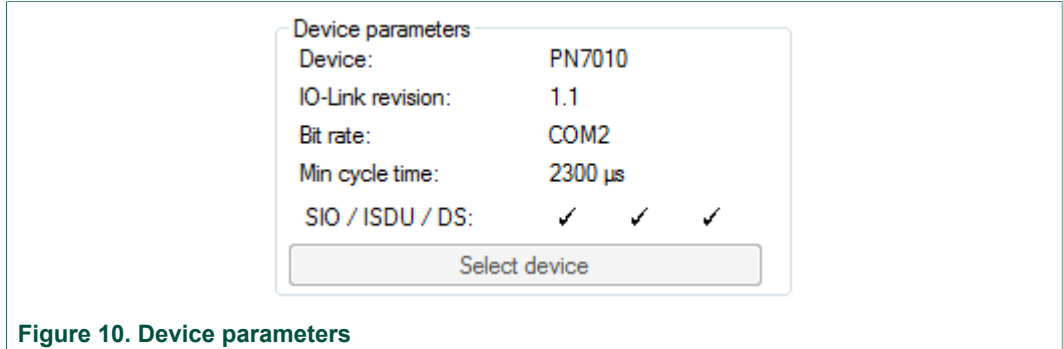

Figure 10. Device parameters

5.6.2.5.2 Device configuration

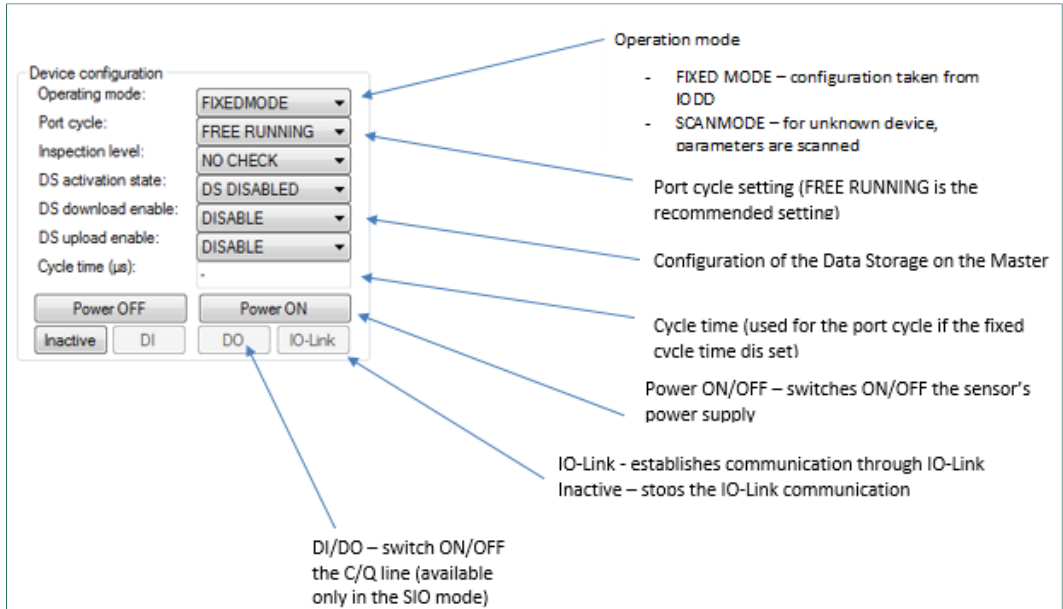

Figure 11. Device configuration



Figure 12. Connected device state

5.6.2.5.3 Parameters

Parameters read from the device

Parameters

SubInd	Name	Rights	Type	Value	Unit

DS upload
Write
Read

Read/Write parameters from/to specific device address

Index: 0
Subindex: 0
Data:

Process Data

Process data collection: V_PD

PD input: Validity: valid

Name	Process data	Unit
Distance absolute	1023	-
Reserved bits	0	-

Raw Process Data In: 0x00 0x03 0xFF

Plot PD in

Process data configuration

Figure 13. Parameters and process data

5.7 Schematics, board layout and bill of materials

Board schematics, board layout and bill of materials are available in the download tab of the tool summary page: www.nxp.com/TWR-CM3120-EVM

5.8 References

The following URLs reference related NXP products and application solutions:

NXP.com support pages	Description	URL
TWR-CM3120-EVM	Tool summary page	www.nxp.com/TWR-CM3120-EVM
	Schematic, BOM, board layout	www.nxp.com/TWR-CM3120-EVM (Download section)
Tower System	Tower System Modular Development Board Platform	www.nxp.com/tower
TWR-K65F180M	www.nxp.com/TWR-K65F180M	www.nxp.com/TWR-K65F180M

5.9 Contact information

Visit <http://www.nxp.com/support> for a list of phone numbers within your region.

Visit <http://www.nxp.com/warranty> to submit a request for tool warranty.

5.10 Revision history

Table 5. Revision history

Document ID	Release date	User guide status	Change notice	Supersedes
KTTWRCM3120UG v2.0	20170508	—	—	1.0
Modifications	<ul style="list-style-type: none"> Updated document format 			
KTTWRCM3120UG v1.0	20151110	Initial release	—	—

6 Legal information

6.1 Definitions

Draft — The document is a draft version only. The content is still under internal review and subject to formal approval, which may result in modifications or additions. NXP Semiconductors does not give any representations or warranties as to the accuracy or completeness of information included herein and shall have no liability for the consequences of use of such information.

6.2 Disclaimers

Information in this document is provided solely to enable system and software implementers to use NXP products. There are no express or implied copyright licenses granted hereunder to design or fabricate any integrated circuits based on the information in this document. NXP reserves the right to make changes without further notice to any products herein.

NXP makes no warranty, representation, or guarantee regarding the suitability of its products for any particular purpose, nor does NXP assume any liability arising out of the application or use of any product or circuit,

and specifically disclaims any and all liability, including without limitation consequential or incidental damages. "Typical" parameters that may be provided in NXP data sheets and/or specifications can and do vary in different applications, and actual performance may vary over time. All operating parameters, including "typicals," must be validated for each customer application by customer's technical experts. NXP does not convey any license under its patent rights nor the rights of others. NXP sells products pursuant to standard terms and conditions of sale, which can be found at the following address: nxp.com/salestermsandconditions.

6.3 Trademarks

Notice: All referenced brands, product names, service names and trademarks are the property of their respective owners.

NXP — is a trademark of NXP B.V.

the NXP logo — is a trademark of NXP B.V.

Freescale — is a trademark of NXP B.V.

the Freescale logo — is a trademark of NXP B.V.

SMARTMOS — is a trademark of NXP B.V.

Tables

Tab. 1.	Device features	7	Tab. 4.	Jumper configuration	16
Tab. 2.	Jumper, connector and switch definitions	9	Tab. 5.	Revision history	25
Tab. 3.	Primary elevator connector pinouts	13			

Figures

Fig. 1.	TWR-CM3120-EVM	1	Fig. 8.	Launching GUI from the Start menu	19
Fig. 2.	TWR-CM3120-EVM on Tower System	5	Fig. 9.	Select device IODD	21
Fig. 3.	TWR-CM3120-EVM as a stand-alone board	5	Fig. 10.	Device parameters	23
Fig. 4.	Block diagram	7	Fig. 11.	Device configuration	23
Fig. 5.	Board description	8	Fig. 12.	Connected device state	23
Fig. 6.	Setting up the hardware	17	Fig. 13.	Parameters and process data	24
Fig. 7.	Installation complete	19			

Contents

1 TWR-CM3120-EVM 1

2 Important notice2

3 Getting started 3

3.1 Kit contents/packing list 3

3.2 Jump start3

3.3 Required equipment 4

3.4 System requirements4

4 Understanding the Tower System 4

5 Getting to know the hardware 6

5.1 Board overview6

5.2 Board features6

5.3 Device features7

5.4 Block diagram7

5.5 Board description8

5.5.1 LED display 9

5.5.2 Jumper, connector and switch definitions9

5.5.3 Elevator connections 13

5.6 Installing the software and setting up the hardware 16

5.6.1 Setting up the hardware 16

5.6.2 Installing the software17

5.6.2.1 Installing USB driver17

5.6.2.2 Installing control tool18

5.6.2.3 Working with the control tool 19

5.6.2.4 Read basic data through IO-link22

5.6.2.5 Interface description23

5.7 Schematics, board layout and bill of materials 25

5.8 References25

5.9 Contact information25

5.10 Revision history25

6 Legal information26

Please be aware that important notices concerning this document and the product(s) described herein, have been included in section 'Legal information'.

© NXP B.V. 2017.

All rights reserved.

For more information, please visit: <http://www.nxp.com>
 For sales office addresses, please send an email to: salesaddresses@nxp.com

Date of release: 8 May 2017