

SPECIFICATION

- Part No. : **TG.35.8113**

- Product Name : Apex II - Hinged TG.35
Ultra-Wideband 4G LTE Antenna

- Features : Highest efficiency for worldwide LTE and WiFi
LTE / HSPA / GSM / CDMA /DCS /PCS / WCDMA /
UMTS / GPRS / EDGE /GPS /Wi-Fi
224mm * 58mm
698MHz to 960MHz, 1575.42MHz
1710MHz to 2700Mhz
5150MHz to 5850MHz
Dipole Swivel Terminal Antenna
Hinged 90° termination with SMA(M) Connector
Enhanced hinge structure for vibration environment
Connector customizable
RoHS Compliant

Photo:



1. Introduction

The hinged Apex II TG.35 Ultra-Wideband Dipole Antenna has been designed to cover all Cellular, ISM and Wi-Fi working frequencies in the 700-6000 MHz spectrum. Evolved from the already highly successful Apex TG.30, this second generation has the highest wide-band efficiency in its range of any terminal antenna on the market today.

The Apex II has been primarily designed for use with 4G LTE modules and devices that require the highest possible efficiency and peak gain to deliver best in class throughput on all major cellular (2G/3G/4G) bands worldwide for access points, terminals and routers. High efficiency is vital for applications such as high speed video and real-time streaming, or high capacity MIMO networks on public transportation.

This attractive slim-line antenna is ground plane independent, meaning it does not need to be connected to the ground-plane of a device to radiate efficiently, on the other hand neither is it seriously detuned by connecting to a ground-plane, thus avoiding a problem notorious to smaller antennas.

It comes with a SMA (M) connector and swivel mechanism that allows the antenna part to be rotated to fit in tight environments. The 90° hinge structure has been improved and strengthened so that the antenna in a 90° position would not fall down to 180° in vibration environment.

The Apex II is backward compatible with 3G and 2G cellular applications such as HSPA, GSM, GPRS, UMTS, WI-FI and even has GPS included for Assisted GPS and/or E911 applications.

In summary the Apex II is the ideal solution for any device requiring high, reliable performance. It will meet most type approval or carrier certification requirements from an efficiency standpoint. The antenna also makes an excellent reference antenna for test purposes. It has been designed as an omni-directional antenna and the radiation patterns prove this, being stable across all bands.

Connector type is customizable. Housing comes in White too. Contact Taoglas regional sales office for more information.

2. Specification

ELECTRICAL								
Standard		LTE/GSM/CDMA 700/850/900	GPS/GLONASS	LTE/GSM/HSPA/CD MA 1700/1800/1900	UMTS/HSPA 2100	Wi-Fi 2400	LTE 2600	Wi-Fi 5800
Frequency (MHz)		698~960	1565~1612	1710~1990	1920~2170	2400~2500	2500~2700	4800~6000
Efficiency (%)								
In free space	straight	53.92	55.66	64.44	62.55	49.61	53.14	56.35
	bent	56.51	55.19	68.87	68.72	53.41	54.11	55.84
On 150*90mm ground plane edge	straight	84.72	66.85	71.00	71.43	56.21	52.22	51.59
	bent	80.92	71.38	71.62	71.14	52.81	53.28	51.82
On 30*30cm ground plane center	straight	59.06	51.56	62.34	61.21	67.43	53.51	51.25
	bent	57.15	36.67	52.88	57.70	60.70	58.10	56.74
On 30*30cm ground plane edge	straight	59.62	48.19	65.51	64.78	63.28	56.84	56.30
	bent	53.18	41.91	63.43	62.24	62.99	46.66	47.09
Average Gain(dBi)								
In free space	straight	-2.71	-2.55	-1.91	-2.05	-3.05	-2.76	-2.59
	bent 90	-2.50	-2.61	-1.63	-1.64	-2.72	-2.67	-2.63
On 150*90mm ground plane edge	straight	-0.74	-1.75	-1.50	-1.46	-2.50	-2.82	-2.92
	bent 90	-0.96	-1.46	-1.45	-1.48	-2.77	-2.74	-2.89
On 30*30cm ground plane center	straight	-2.31	-2.88	-2.06	-2.13	-1.74	-2.72	-2.94
	bent 90	-2.44	-4.36	-2.78	-2.40	-2.18	-2.37	-2.52
On 30*30cm ground plane center	straight	-2.26	-3.17	-1.85	-1.89	-2.01	-2.45	-2.58
	bent 90	-2.81	-3.78	-1.99	-2.08	-2.02	-3.32	-3.37
Peak Gain(dBi)								
In free space	straight	4.42	1.59	3.15	2.70	4.93	4.43	2.55
	bent	3.16	1.64	3.37	3.34	3.28	3.06	2.09
On the 150*90mm ground plane edge	straight	3.28	3.70	4.79	5.02	2.50	2.36	2.67
	bent	2.77	3.24	4.07	4.35	4.47	3.80	2.68
On the 30*30cm ground plane center	straight	6.37	0.75	3.34	3.39	6.44	6.92	5.29
	bent	6.47	5.12	6.27	6.44	5.78	8.14	6.05
On the 30*30cm ground plane center	straight	4.87	1.70	3.62	4.01	4.63	6.02	4.87
	bent	4.78	4.07	5.95	5.45	5.87	3.89	4.59
In free space	straight	4.42	1.59	3.15	2.70	4.93	4.43	2.55
	bent	3.16	1.64	3.37	3.34	3.28	3.06	2.09
Impedance				50Ω				
Polarization				Linear				
Radiation Pattern				Omni				
Input Power				5 W				

MECHANICAL	
Casing	UV Resistant PC/ABS
Connector	SMA Male Hinged 90°
Weight	75g
Recommended Torque for Mounting	0.9 N·m
Max torque for Mounting	1.176 N·m
ENVIRONMENTAL	
Temperature Range	-40°C to 85°C
Humidity	Non-condensing 65°C 95% RH

2.1 LTE Bands bent 90 degrees on 30*30cm on center Ground Plane

LTE BANDS			
Band Number	LTE / LTE-Advanced / WCDMA / HSPA / HSPA+ / TD-SCDMA		
	Uplink	Downlink	Covered
1	UL: 1920 to 1980	DL: 2110 to 2170	✓
2	UL: 1850 to 1910	DL: 1930 to 1990	✓
3	UL: 1710 to 1785	DL: 1805 to 1880	✓
4	UL: 1710 to 1755	DL: 2110 to 2155	✓
5	UL: 824 to 849	DL: 869 to 894	✓
7	UL: 2500 to 2570	DL: 2620 to 2690	✓
8	UL: 880 to 915	DL: 925 to 960	✓
9	UL: 1749.9 to 1784.9	DL: 1844.9 to 1879.9	✓
11	UL: 1427.9 to 1447.9	DL: 1475.9 to 1495.9	✓
12	UL: 699 to 716	DL: 729 to 746	✓
13	UL: 777 to 787	DL: 746 to 756	✓
14	UL: 788 to 798	DL: 758 to 768	✓
17	UL: 704 to 716	DL: 734 to 746 (LTE only)	✓
18	UL: 815 to 830	DL: 860 to 875 (LTE only)	✓
19	UL: 830 to 845	DL: 875 to 890	✓
20	UL: 832 to 862	DL: 791 to 821	✓
21	UL: 1447.9 to 1462.9	DL: 1495.9 to 1510.9	✓
22	UL: 3410 to 3490	DL: 3510 to 3590	✓
23	UL: 2000 to 2020	DL: 2180 to 2200 (LTE only)	✓
24	UL: 1625.5 to 1660.5	DL: 1525 to 1559 (LTE only)	✓
25	UL: 1850 to 1915	DL: 1930 to 1995	✓
26	UL: 814 to 849	DL: 859 to 894	✓
27	UL: 807 to 824	DL: 852 to 869 (LTE only)	✓
28	UL: 703 to 748	DL: 758 to 803 (LTE only)	✓
29	UL: -	DL: 717 to 728 (LTE only)	✓
30	UL: 2305 to 2315	DL: 2350 to 2360 (LTE only)	✓
31	UL: 452.5 to 457.5	DL: 462.5 to 467.5 (LTE only)	✗
32	UL: -	DL: 1452 - 1496	✓
35		1850 to 1910	✓
38		2570 to 2620	✓
39		1880 to 1920	✓
40		2300 to 2400	✓
41		2496 to 2690	✓
42		3400 to 3600	✓
43		3600 to 3800	✗

2.2 LTE Bands straight on 30*30cm on Ground Plane edge

LTE BANDS			
Band Number	LTE / LTE-Advanced / WCDMA / HSPA / HSPA+ / TD-SCDMA		
	Uplink	Downlink	Covered
1	UL: 1920 to 1980	DL: 2110 to 2170	✓
2	UL: 1850 to 1910	DL: 1930 to 1990	✓
3	UL: 1710 to 1785	DL: 1805 to 1880	✓
4	UL: 1710 to 1755	DL: 2110 to 2155	✓
5	UL: 824 to 849	DL: 869 to 894	✓
7	UL: 2500 to 2570	DL: 2620 to 2690	✓
8	UL: 880 to 915	DL: 925 to 960	✓
9	UL: 1749.9 to 1784.9	DL: 1844.9 to 1879.9	✓
11	UL: 1427.9 to 1447.9	DL: 1475.9 to 1495.9	✓
12	UL: 699 to 716	DL: 729 to 746	✓
13	UL: 777 to 787	DL: 746 to 756	✓
14	UL: 788 to 798	DL: 758 to 768	✓
17	UL: 704 to 716	DL: 734 to 746 (LTE only)	✓
18	UL: 815 to 830	DL: 860 to 875 (LET only)	✓
19	UL: 830 to 845	DL: 875 to 890	✓
20	UL: 832 to 862	DL: 791 to 821	✓
21	UL: 1447.9 to 1462.9	DL: 1495.9 to 1510.9	✓
22	UL: 3410 to 3490	DL: 3510 to 3590	✓
23	UL: 2000 to 2020	DL: 2180 to 2200 (LTE only)	✓
24	UL: 1625.5 to 1660.5	DL: 1525 to 1559 (LTE only)	✓
25	UL: 1850 to 1915	DL: 1930 to 1995	✓
26	UL: 814 to 849	DL: 859 to 894	✓
27	UL: 807 to 824	DL: 852 to 869 (LTE only)	✓
28	UL: 703 to 748	DL: 758 to 803 (LTE only)	✓
29	UL: -	DL: 717 to 728 (LTE only)	✓
30	UL: 2305 to 2315	DL: 2350 to 2360 (LTE only)	✓
31	UL: 452.5 to 457.5	DL: 462.5 to 467.5 (LTE only)	✗
32	UL: -	DL: 1452 - 1496	✓
35		1850 to 1910	✓
38		2570 to 2620	✓
39		1880 to 1920	✓
40		2300 to 2400	✓
41		2496 to 2690	✓
42		3400 to 3600	✓
43		3600 to 3800	✗

2.3 LTE Bands bent 90 degrees on 30*30cm on Ground Plane edge

LTE BANDS			
Band Number	LTE / LTE-Advanced / WCDMA / HSPA / HSPA+ / TD-SCDMA		
	Uplink	Downlink	Covered
1	UL: 1920 to 1980	DL: 2110 to 2170	✓
2	UL: 1850 to 1910	DL: 1930 to 1990	✓
3	UL: 1710 to 1785	DL: 1805 to 1880	✓
4	UL: 1710 to 1755	DL: 2110 to 2155	✓
5	UL: 824 to 849	DL: 869 to 894	✓
7	UL: 2500 to 2570	DL: 2620 to 2690	✓
8	UL: 880 to 915	DL: 925 to 960	✓
9	UL: 1749.9 to 1784.9	DL: 1844.9 to 1879.9	✓
11	UL: 1427.9 to 1447.9	DL: 1475.9 to 1495.9	✓
12	UL: 699 to 716	DL: 729 to 746	✓
13	UL: 777 to 787	DL: 746 to 756	✓
14	UL: 788 to 798	DL: 758 to 768	✓
17	UL: 704 to 716	DL: 734 to 746 (LTE only)	✓
18	UL: 815 to 830	DL: 860 to 875 (LTE only)	✓
19	UL: 830 to 845	DL: 875 to 890	✓
20	UL: 832 to 862	DL: 791 to 821	✓
21	UL: 1447.9 to 1462.9	DL: 1495.9 to 1510.9	✓
22	UL: 3410 to 3490	DL: 3510 to 3590	✓
23	UL: 2000 to 2020	DL: 2180 to 2200 (LTE only)	✓
24	UL: 1625.5 to 1660.5	DL: 1525 to 1559 (LTE only)	✓
25	UL: 1850 to 1915	DL: 1930 to 1995	✓
26	UL: 814 to 849	DL: 859 to 894	✓
27	UL: 807 to 824	DL: 852 to 869 (LTE only)	✓
28	UL: 703 to 748	DL: 758 to 803 (LTE only)	✓
29	UL: -	DL: 717 to 728 (LTE only)	✓
30	UL: 2305 to 2315	DL: 2350 to 2360 (LTE only)	✓
31	UL: 452.5 to 457.5	DL: 462.5 to 467.5 (LTE only)	✗
32	UL: -	DL: 1452 - 1496	✓
35		1850 to 1910	✓
38		2570 to 2620	✓
39		1880 to 1920	✓
40		2300 to 2400	✓
41		2496 to 2690	✓
42		3400 to 3600	✓
43		3600 to 3800	✗

2.4 LTE Bands straight on 30*30cm on center Ground Plane

LTE BANDS			
Band Number	LTE / LTE-Advanced / WCDMA / HSPA / HSPA+ / TD-SCDMA		
	Uplink	Downlink	Covered
1	UL: 1920 to 1980	DL: 2110 to 2170	✓
2	UL: 1850 to 1910	DL: 1930 to 1990	✓
3	UL: 1710 to 1785	DL: 1805 to 1880	✓
4	UL: 1710 to 1755	DL: 2110 to 2155	✓
5	UL: 824 to 849	DL: 869 to 894	✓
7	UL: 2500 to 2570	DL: 2620 to 2690	✓
8	UL: 880 to 915	DL: 925 to 960	✓
9	UL: 1749.9 to 1784.9	DL: 1844.9 to 1879.9	✓
11	UL: 1427.9 to 1447.9	DL: 1475.9 to 1495.9	✓
12	UL: 699 to 716	DL: 729 to 746	✓
13	UL: 777 to 787	DL: 746 to 756	✓
14	UL: 788 to 798	DL: 758 to 768	✓
17	UL: 704 to 716	DL: 734 to 746 (LTE only)	✓
18	UL: 815 to 830	DL: 860 to 875 (LTE only)	✓
19	UL: 830 to 845	DL: 875 to 890	✓
20	UL: 832 to 862	DL: 791 to 821	✓
21	UL: 1447.9 to 1462.9	DL: 1495.9 to 1510.9	✓
22	UL: 3410 to 3490	DL: 3510 to 3590	✓
23	UL: 2000 to 2020	DL: 2180 to 2200 (LTE only)	✓
24	UL: 1625.5 to 1660.5	DL: 1525 to 1559 (LTE only)	✓
25	UL: 1850 to 1915	DL: 1930 to 1995	✓
26	UL: 814 to 849	DL: 859 to 894	✓
27	UL: 807 to 824	DL: 852 to 869 (LTE only)	✓
28	UL: 703 to 748	DL: 758 to 803 (LTE only)	✓
29	UL: -	DL: 717 to 728 (LTE only)	✓
30	UL: 2305 to 2315	DL: 2350 to 2360 (LTE only)	✓
31	UL: 452.5 to 457.5	DL: 462.5 to 467.5 (LTE only)	✗
32	UL: -	DL: 1452 - 1496	✓
35		1850 to 1910	✓
38		2570 to 2620	✓
39		1880 to 1920	✓
40		2300 to 2400	✓
41		2496 to 2690	✓
42		3400 to 3600	✓
43		3600 to 3800	✗

2.5 LTE Bands straight in free space

LTE BANDS			
Band Number	LTE / LTE-Advanced / WCDMA / HSPA / HSPA+ / TD-SCDMA		
	Uplink	Downlink	Covered
1	UL: 1920 to 1980	DL: 2110 to 2170	✓
2	UL: 1850 to 1910	DL: 1930 to 1990	✓
3	UL: 1710 to 1785	DL: 1805 to 1880	✓
4	UL: 1710 to 1755	DL: 2110 to 2155	✓
5	UL: 824 to 849	DL: 869 to 894	✓
7	UL: 2500 to 2570	DL: 2620 to 2690	✓
8	UL: 880 to 915	DL: 925 to 960	✓
9	UL: 1749.9 to 1784.9	DL: 1844.9 to 1879.9	✓
11	UL: 1427.9 to 1447.9	DL: 1475.9 to 1495.9	✓
12	UL: 699 to 716	DL: 729 to 746	✓
13	UL: 777 to 787	DL: 746 to 756	✓
14	UL: 788 to 798	DL: 758 to 768	✓
17	UL: 704 to 716	DL: 734 to 746 (LTE only)	✓
18	UL: 815 to 830	DL: 860 to 875 (LET only)	✓
19	UL: 830 to 845	DL: 875 to 890	✓
20	UL: 832 to 862	DL: 791 to 821	✓
21	UL: 1447.9 to 1462.9	DL: 1495.9 to 1510.9	✓
22	UL: 3410 to 3490	DL: 3510 to 3590	✓
23	UL: 2000 to 2020	DL: 2180 to 2200 (LTE only)	✓
24	UL: 1625.5 to 1660.5	DL: 1525 to 1559 (LTE only)	✓
25	UL: 1850 to 1915	DL: 1930 to 1995	✓
26	UL: 814 to 849	DL: 859 to 894	✓
27	UL: 807 to 824	DL: 852 to 869 (LTE only)	✓
28	UL: 703 to 748	DL: 758 to 803 (LTE only)	✓
29	UL: -	DL: 717 to 728 (LTE only)	✓
30	UL: 2305 to 2315	DL: 2350 to 2360 (LTE only)	✓
31	UL: 452.5 to 457.5	DL: 462.5 to 467.5 (LTE only)	✗
32	UL: -	DL: 1452 - 1496	✓
35		1850 to 1910	✓
38		2570 to 2620	✓
39		1880 to 1920	✓
40		2300 to 2400	✓
41		2496 to 2690	✓
42		3400 to 3600	✓
43		3600 to 3800	✗

2.6 LTE Bands bent 90 degrees in free space

LTE BANDS			
Band Number	LTE / LTE-Advanced / WCDMA / HSPA / HSPA+ / TD-SCDMA		
	Uplink	Downlink	Covered
1	UL: 1920 to 1980	DL: 2110 to 2170	✓
2	UL: 1850 to 1910	DL: 1930 to 1990	✓
3	UL: 1710 to 1785	DL: 1805 to 1880	✓
4	UL: 1710 to 1755	DL: 2110 to 2155	✓
5	UL: 824 to 849	DL: 869 to 894	✓
7	UL: 2500 to 2570	DL: 2620 to 2690	✓
8	UL: 880 to 915	DL: 925 to 960	✓
9	UL: 1749.9 to 1784.9	DL: 1844.9 to 1879.9	✓
11	UL: 1427.9 to 1447.9	DL: 1475.9 to 1495.9	✓
12	UL: 699 to 716	DL: 729 to 746	✓
13	UL: 777 to 787	DL: 746 to 756	✓
14	UL: 788 to 798	DL: 758 to 768	✓
17	UL: 704 to 716	DL: 734 to 746 (LTE only)	✓
18	UL: 815 to 830	DL: 860 to 875 (LTE only)	✓
19	UL: 830 to 845	DL: 875 to 890	✓
20	UL: 832 to 862	DL: 791 to 821	✓
21	UL: 1447.9 to 1462.9	DL: 1495.9 to 1510.9	✓
22	UL: 3410 to 3490	DL: 3510 to 3590	✓
23	UL: 2000 to 2020	DL: 2180 to 2200 (LTE only)	✓
24	UL: 1625.5 to 1660.5	DL: 1525 to 1559 (LTE only)	✓
25	UL: 1850 to 1915	DL: 1930 to 1995	✓
26	UL: 814 to 849	DL: 859 to 894	✓
27	UL: 807 to 824	DL: 852 to 869 (LTE only)	✓
28	UL: 703 to 748	DL: 758 to 803 (LTE only)	✓
29	UL: -	DL: 717 to 728 (LTE only)	✓
30	UL: 2305 to 2315	DL: 2350 to 2360 (LTE only)	✓
31	UL: 452.5 to 457.5	DL: 462.5 to 467.5 (LTE only)	✗
32	UL: -	DL: 1452 - 1496	✓
35		1850 to 1910	✓
38		2570 to 2620	✓
39		1880 to 1920	✓
40		2300 to 2400	✓
41		2496 to 2690	✓
42		3400 to 3600	✓
43		3600 to 3800	✗

2.7 LTE Bands straight on 150*90mm Ground Plane edge

LTE BANDS			
Band Number	LTE / LTE-Advanced / WCDMA / HSPA / HSPA+ / TD-SCDMA		
	Uplink	Downlink	Covered
1	UL: 1920 to 1980	DL: 2110 to 2170	✓
2	UL: 1850 to 1910	DL: 1930 to 1990	✓
3	UL: 1710 to 1785	DL: 1805 to 1880	✓
4	UL: 1710 to 1755	DL: 2110 to 2155	✓
5	UL: 824 to 849	DL: 869 to 894	✓
7	UL: 2500 to 2570	DL: 2620 to 2690	✓
8	UL: 880 to 915	DL: 925 to 960	✓
9	UL: 1749.9 to 1784.9	DL: 1844.9 to 1879.9	✓
11	UL: 1427.9 to 1447.9	DL: 1475.9 to 1495.9	✓
12	UL: 699 to 716	DL: 729 to 746	✓
13	UL: 777 to 787	DL: 746 to 756	✓
14	UL: 788 to 798	DL: 758 to 768	✓
17	UL: 704 to 716	DL: 734 to 746 (LTE only)	✓
18	UL: 815 to 830	DL: 860 to 875 (LTE only)	✓
19	UL: 830 to 845	DL: 875 to 890	✓
20	UL: 832 to 862	DL: 791 to 821	✓
21	UL: 1447.9 to 1462.9	DL: 1495.9 to 1510.9	✓
22	UL: 3410 to 3490	DL: 3510 to 3590	✓
23	UL: 2000 to 2020	DL: 2180 to 2200 (LTE only)	✓
24	UL: 1625.5 to 1660.5	DL: 1525 to 1559 (LTE only)	✓
25	UL: 1850 to 1915	DL: 1930 to 1995	✓
26	UL: 814 to 849	DL: 859 to 894	✓
27	UL: 807 to 824	DL: 852 to 869 (LTE only)	✓
28	UL: 703 to 748	DL: 758 to 803 (LTE only)	✓
29	UL: -	DL: 717 to 728 (LTE only)	✓
30	UL: 2305 to 2315	DL: 2350 to 2360 (LTE only)	✓
31	UL: 452.5 to 457.5	DL: 462.5 to 467.5 (LTE only)	✗
32	UL: -	DL: 1452 - 1496	✓
35		1850 to 1910	✓
38		2570 to 2620	✓
39		1880 to 1920	✓
40		2300 to 2400	✓
41		2496 to 2690	✓
42		3400 to 3600	✓
43		3600 to 3800	✗

2.8 LTE Bands bent 90 degrees on 150*90mm Ground Plane edge

LTE BANDS			
Band Number	LTE / LTE-Advanced / WCDMA / HSPA / HSPA+ / TD-SCDMA		
	Uplink	Downlink	Covered
1	UL: 1920 to 1980	DL: 2110 to 2170	✓
2	UL: 1850 to 1910	DL: 1930 to 1990	✓
3	UL: 1710 to 1785	DL: 1805 to 1880	✓
4	UL: 1710 to 1755	DL: 2110 to 2155	✓
5	UL: 824 to 849	DL: 869 to 894	✓
7	UL: 2500 to 2570	DL: 2620 to 2690	✓
8	UL: 880 to 915	DL: 925 to 960	✓
9	UL: 1749.9 to 1784.9	DL: 1844.9 to 1879.9	✓
11	UL: 1427.9 to 1447.9	DL: 1475.9 to 1495.9	✓
12	UL: 699 to 716	DL: 729 to 746	✓
13	UL: 777 to 787	DL: 746 to 756	✓
14	UL: 788 to 798	DL: 758 to 768	✓
17	UL: 704 to 716	DL: 734 to 746 (LTE only)	✓
18	UL: 815 to 830	DL: 860 to 875 (LET only)	✓
19	UL: 830 to 845	DL: 875 to 890	✓
20	UL: 832 to 862	DL: 791 to 821	✓
21	UL: 1447.9 to 1462.9	DL: 1495.9 to 1510.9	✓
22	UL: 3410 to 3490	DL: 3510 to 3590	✗
23	UL: 2000 to 2020	DL: 2180 to 2200 (LTE only)	✓
24	UL: 1625.5 to 1660.5	DL: 1525 to 1559 (LTE only)	✓
25	UL: 1850 to 1915	DL: 1930 to 1995	✓
26	UL: 814 to 849	DL: 859 to 894	✓
27	UL: 807 to 824	DL: 852 to 869 (LTE only)	✓
28	UL: 703 to 748	DL: 758 to 803 (LTE only)	✓
29	UL: -	DL: 717 to 728 (LTE only)	✓
30	UL: 2305 to 2315	DL: 2350 to 2360 (LTE only)	✓
31	UL: 452.5 to 457.5	DL: 462.5 to 467.5 (LTE only)	✗
32	UL: -	DL: 1452 - 1496	✓
35		1850 to 1910	✓
38		2570 to 2620	✓
39		1880 to 1920	✓
40		2300 to 2400	✓
41		2496 to 2690	✓
42		3400 to 3600	✓
43		3600 to 3800	✗

3. Antenna Characteristics

3.1 Testing setup

In free space

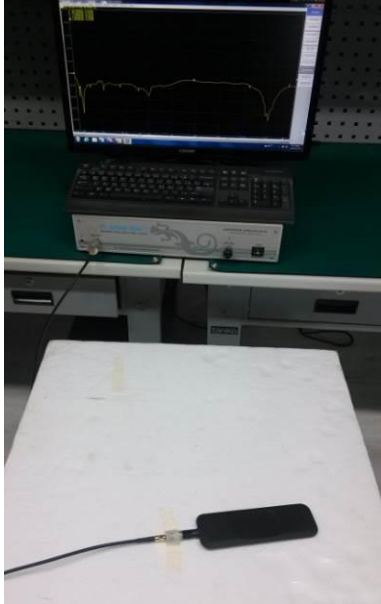

Antenna straight

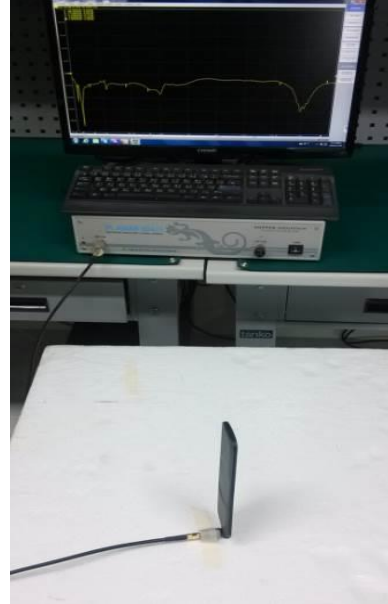

Antenna bent 90

On 150*90mm ground plane edge



Antenna straight

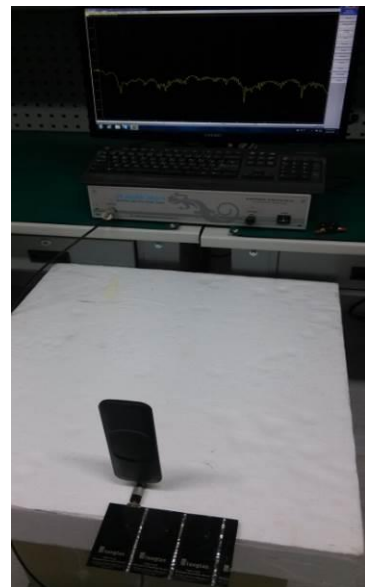

Antenna bent 90

On 30cm*30cm ground plane center

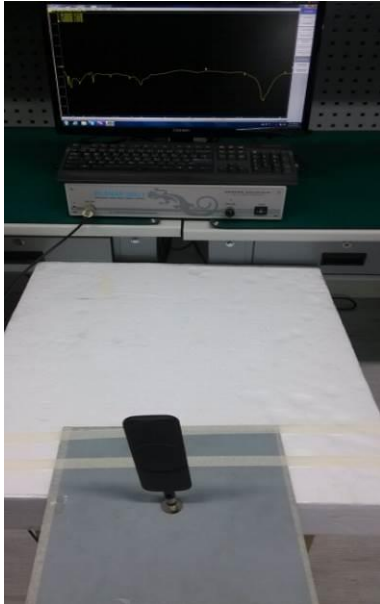

Antenna straight

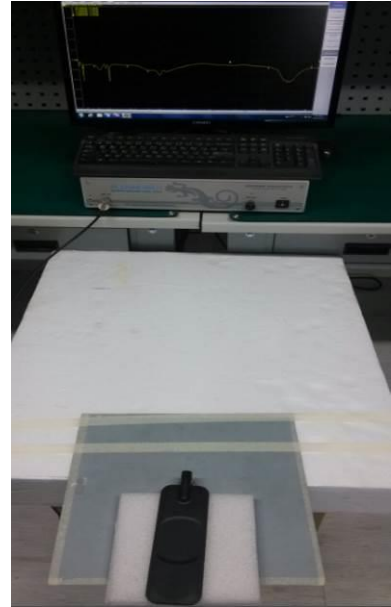

Antenna bent 90

On 30cm*30cm ground plane edge

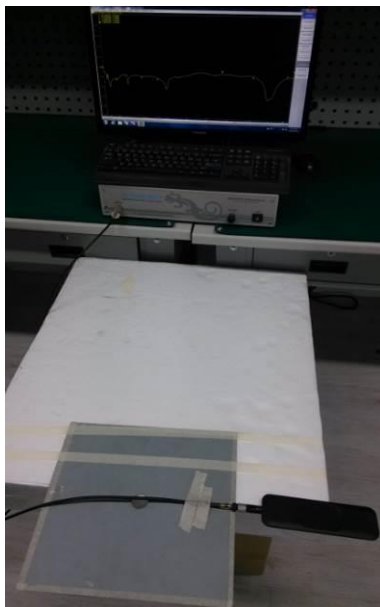

Antenna straight



Antenna bent 90

3.2 Return Loss

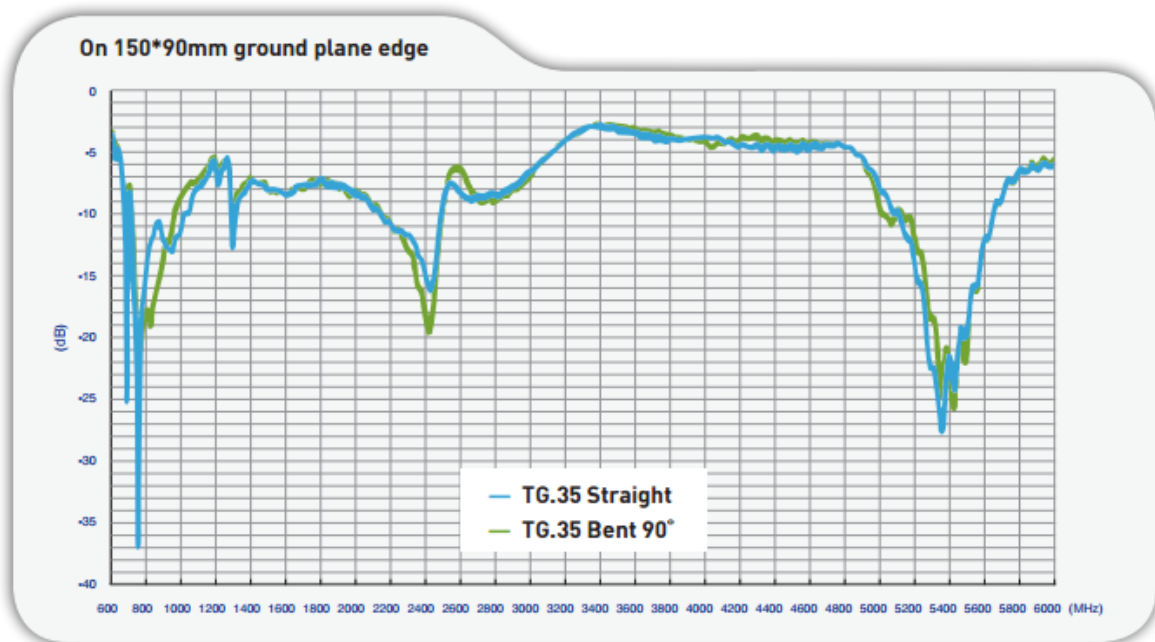
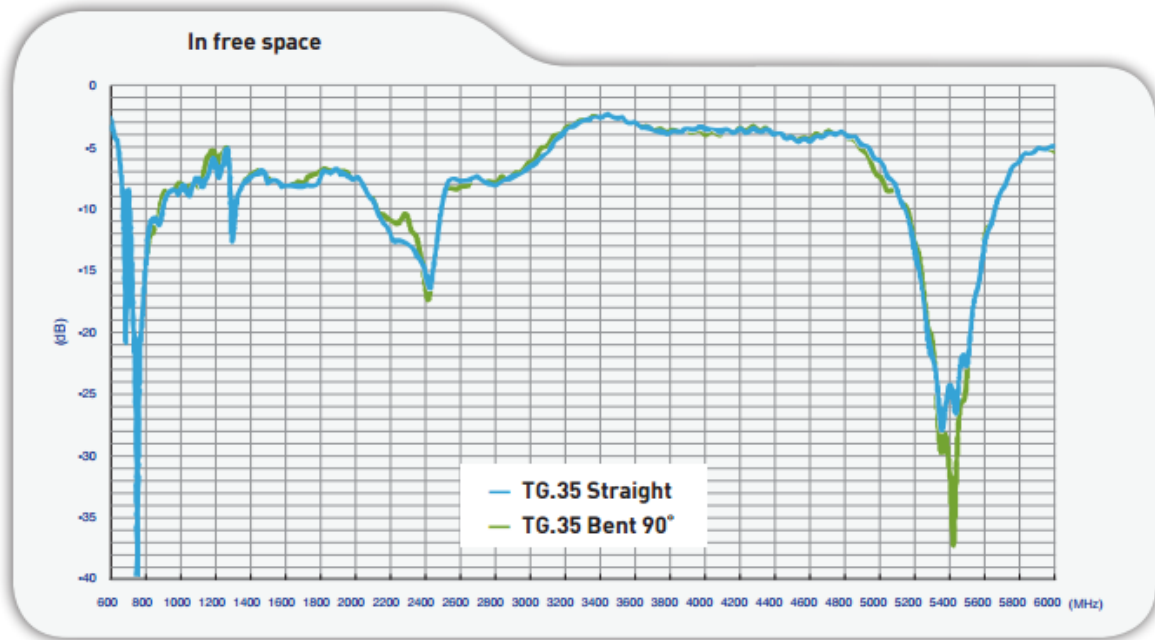

On 30cm*30cm ground plane center

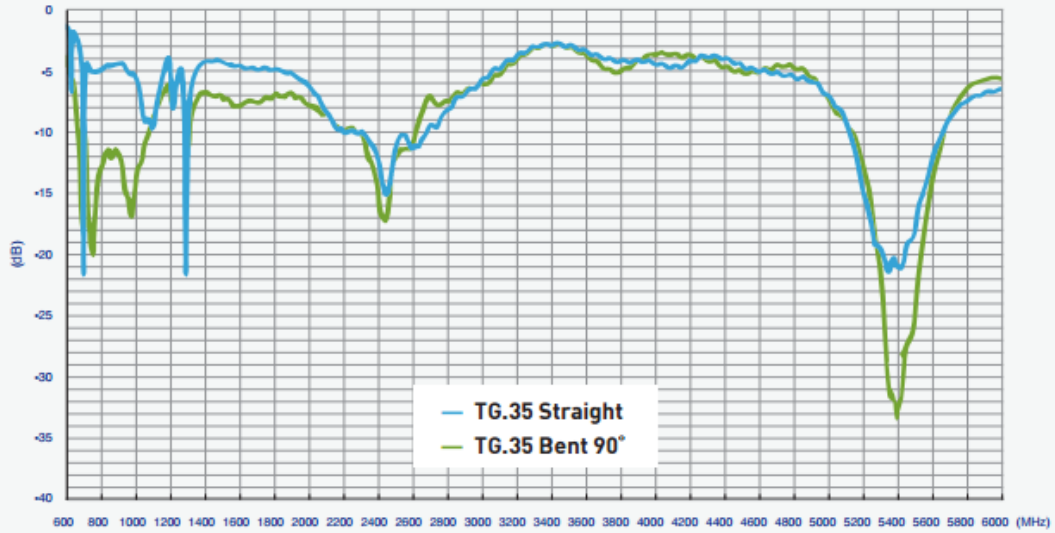

On 30cm*30cm ground plane edge

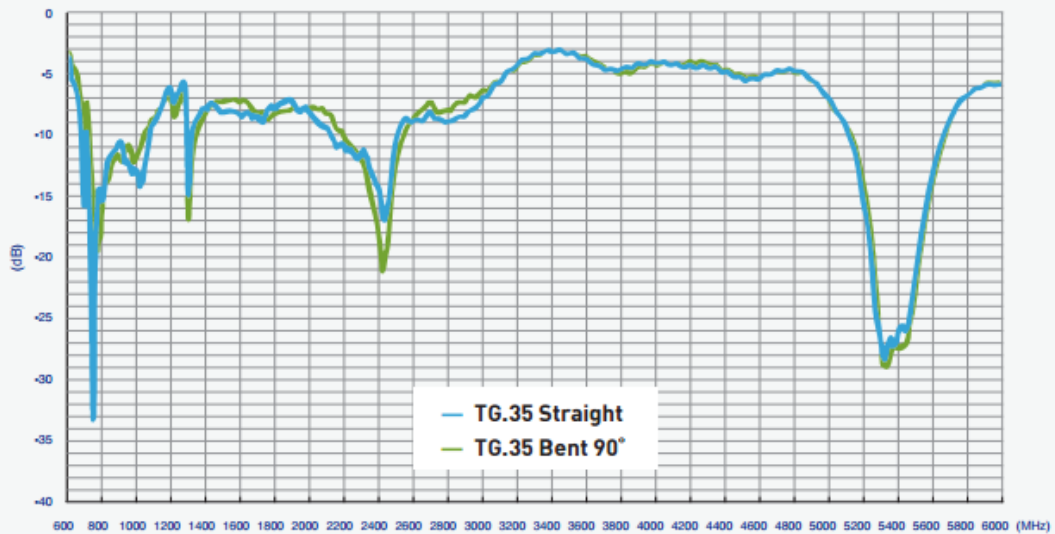

3.3 Peak Gain

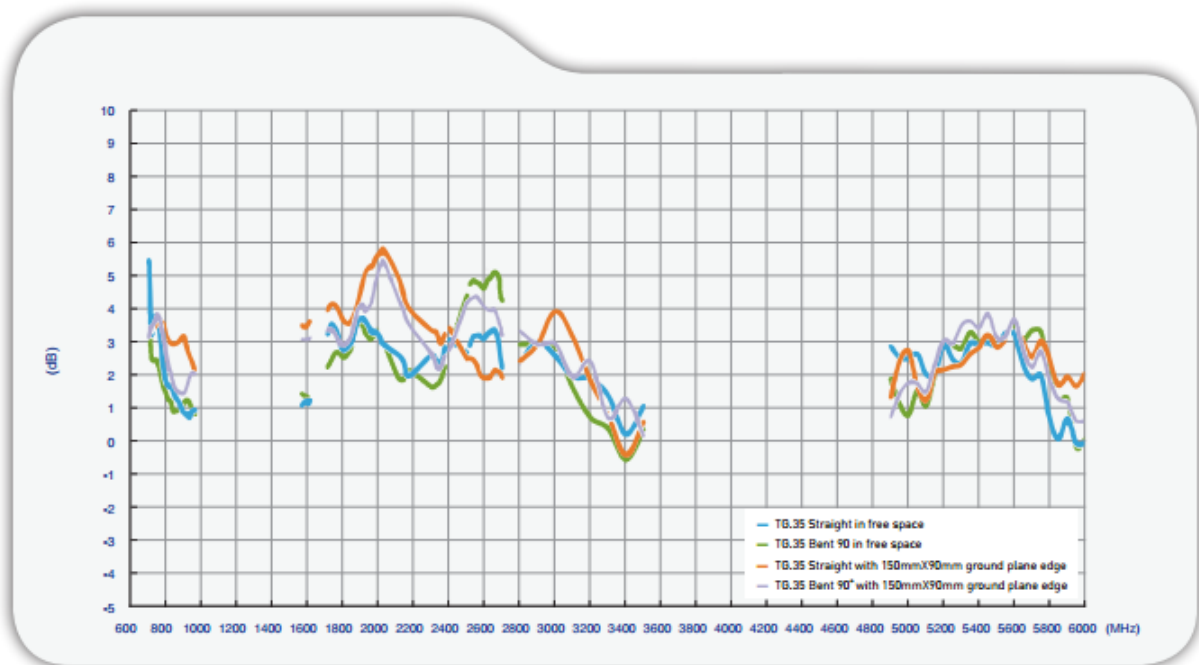
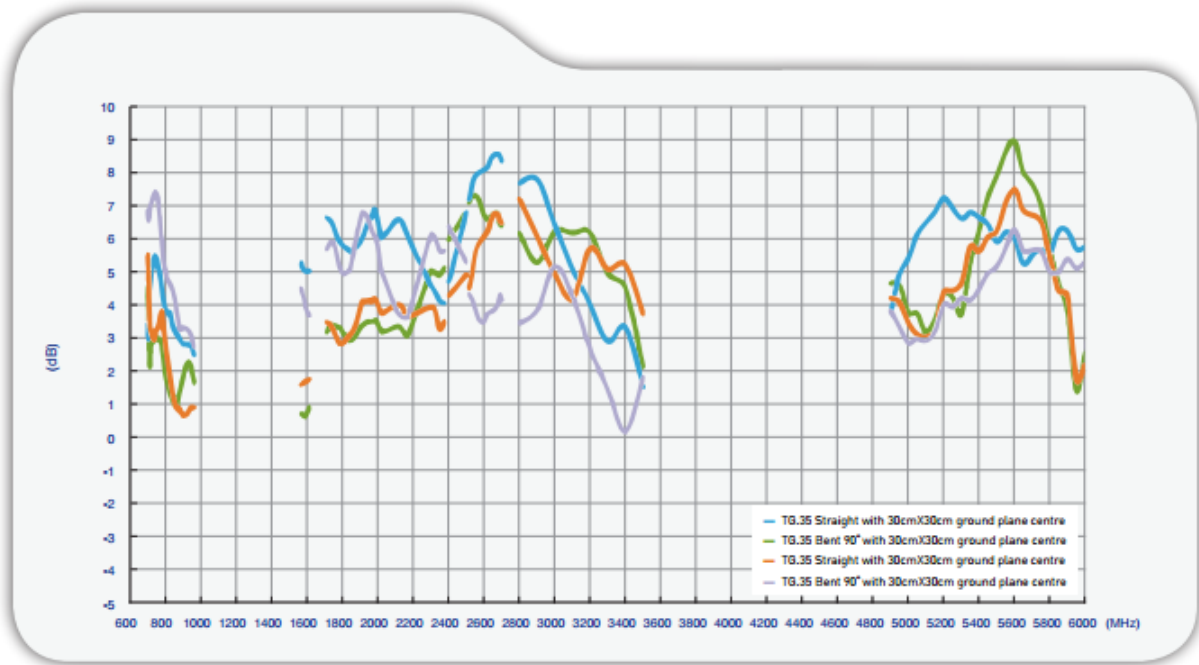

3.4 Efficiency

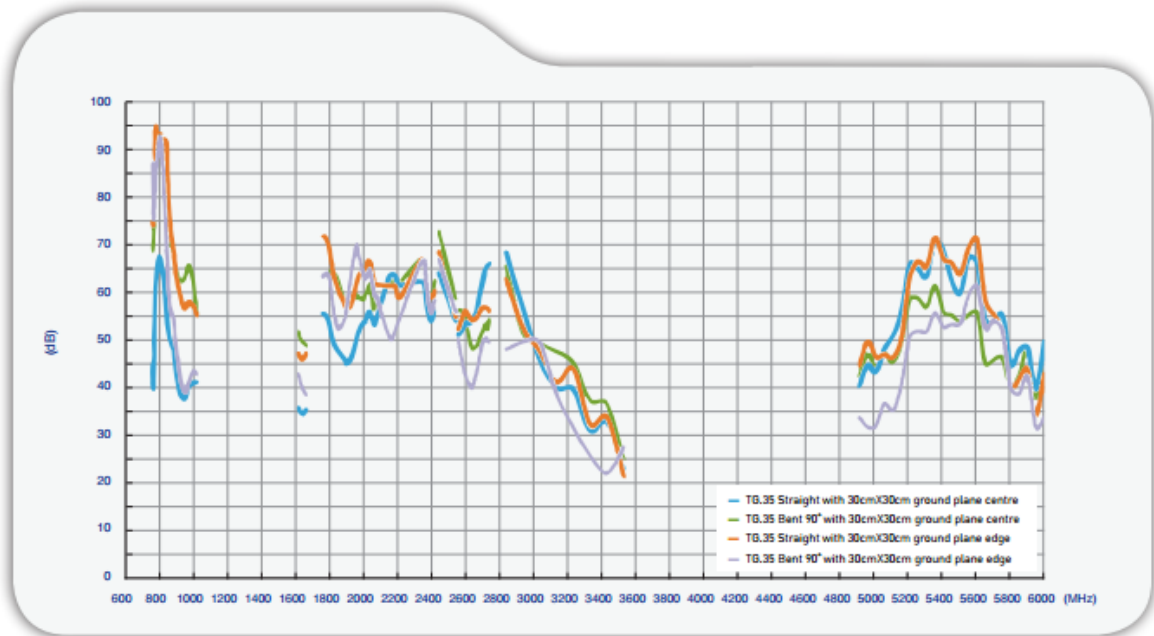

3.5 Average Gain

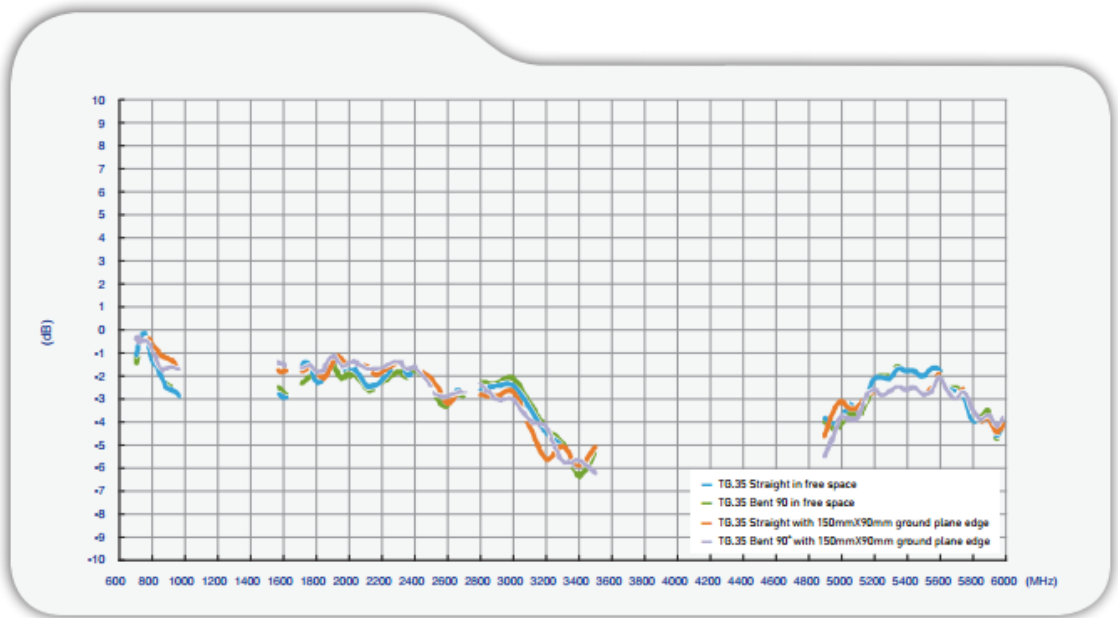
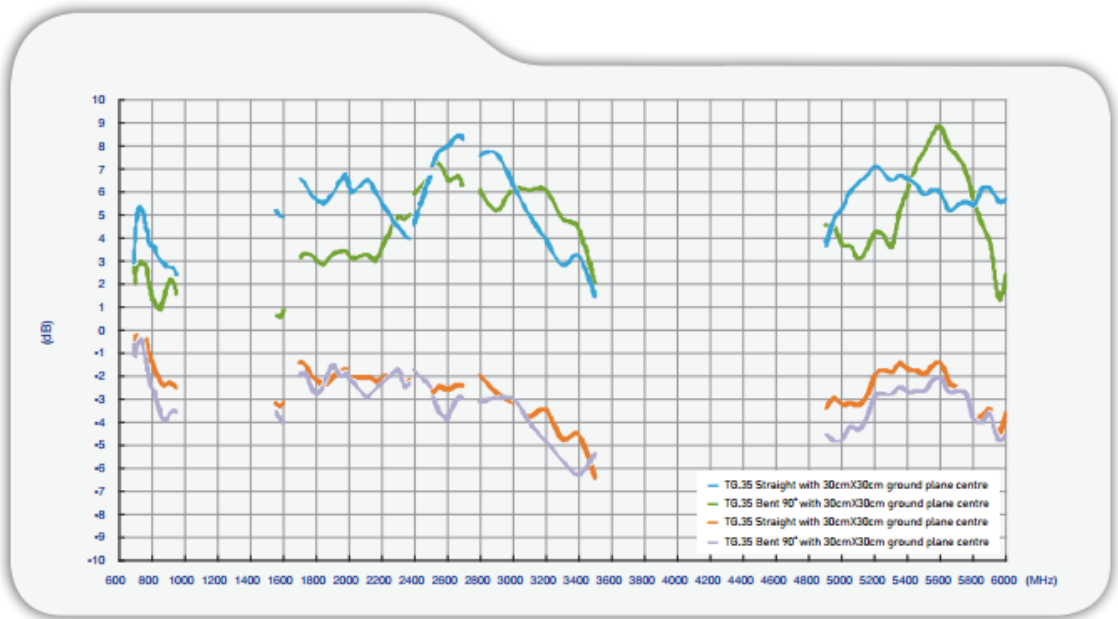

4. Antenna Radiation Patterns

4.1 Antenna setup

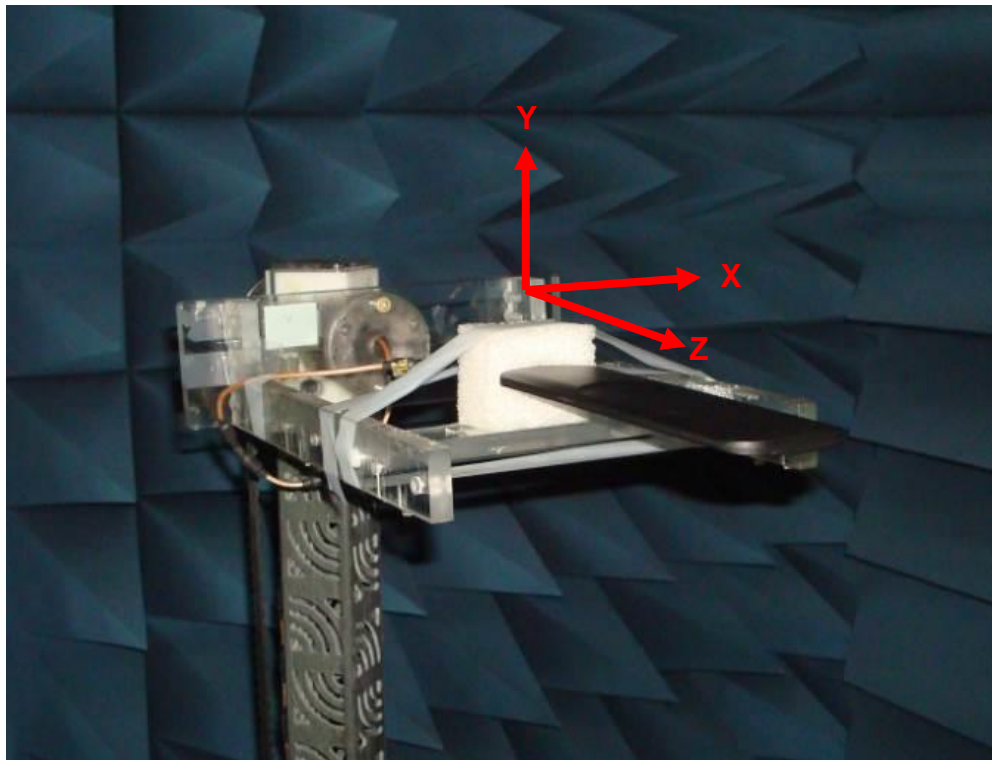

Antenna straight in the free space

4.2 Antenna radiation patterns

4.2.1 Antenna straight in free space

X-Y plane

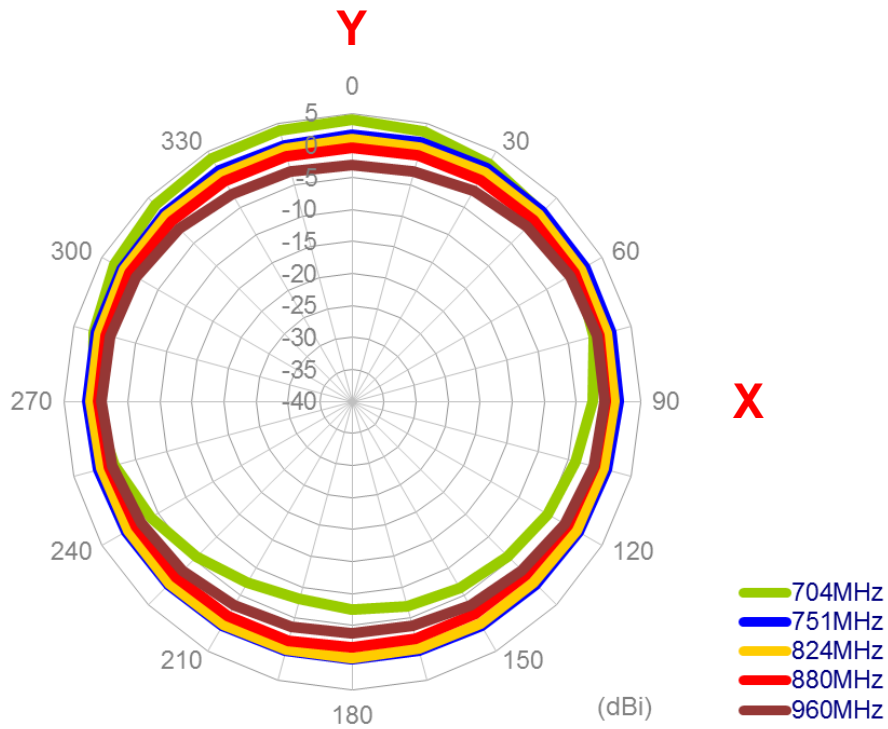

X-Z plane

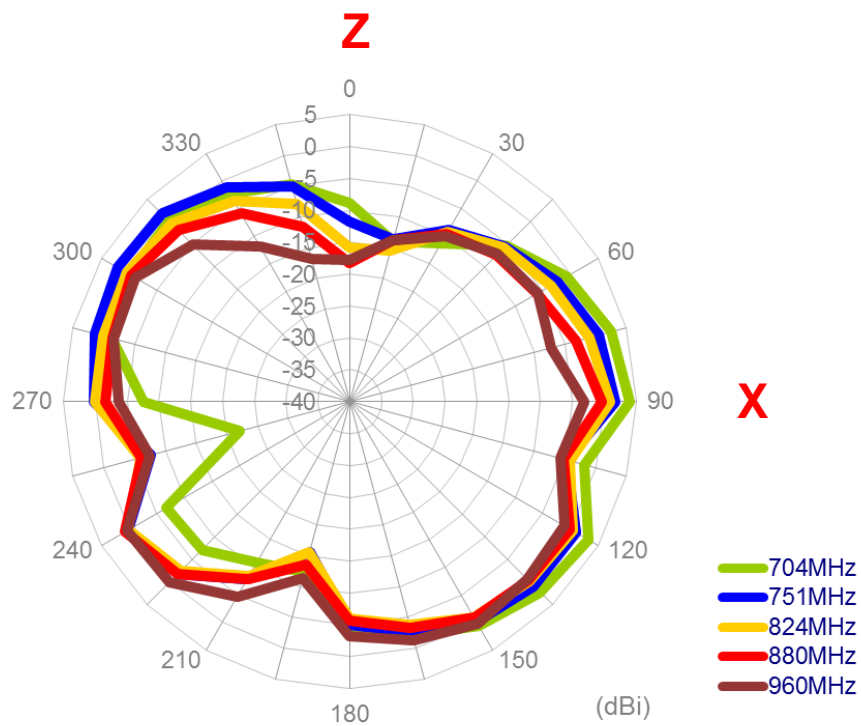

Y-Z plane

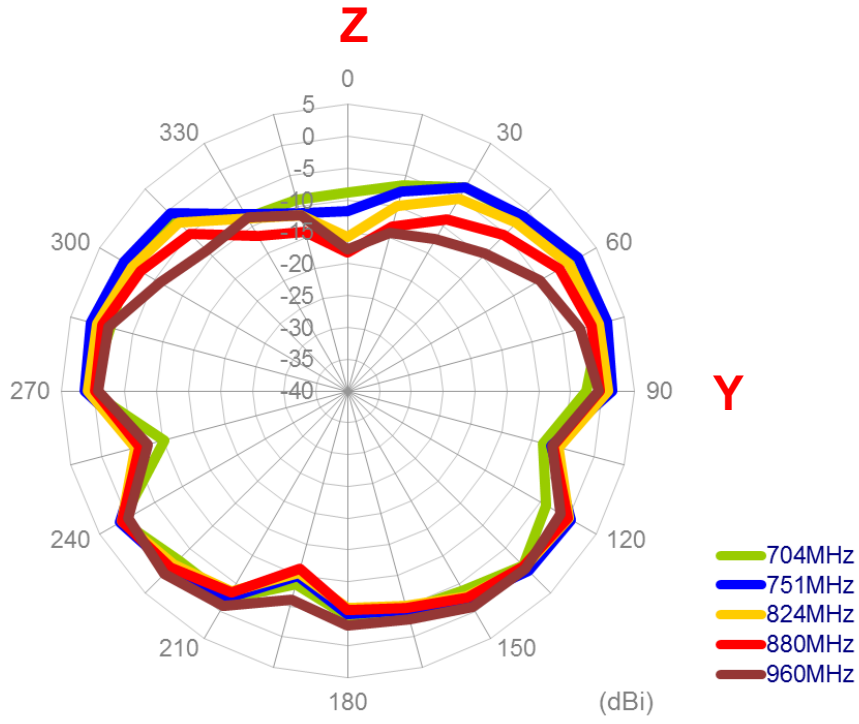

X-Y plane

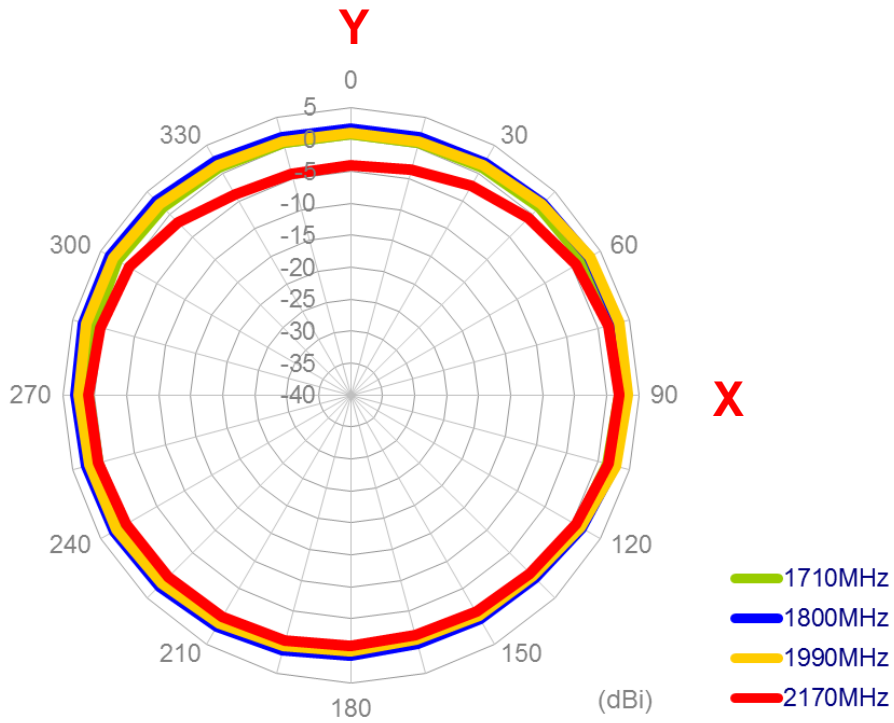

X-Z plane

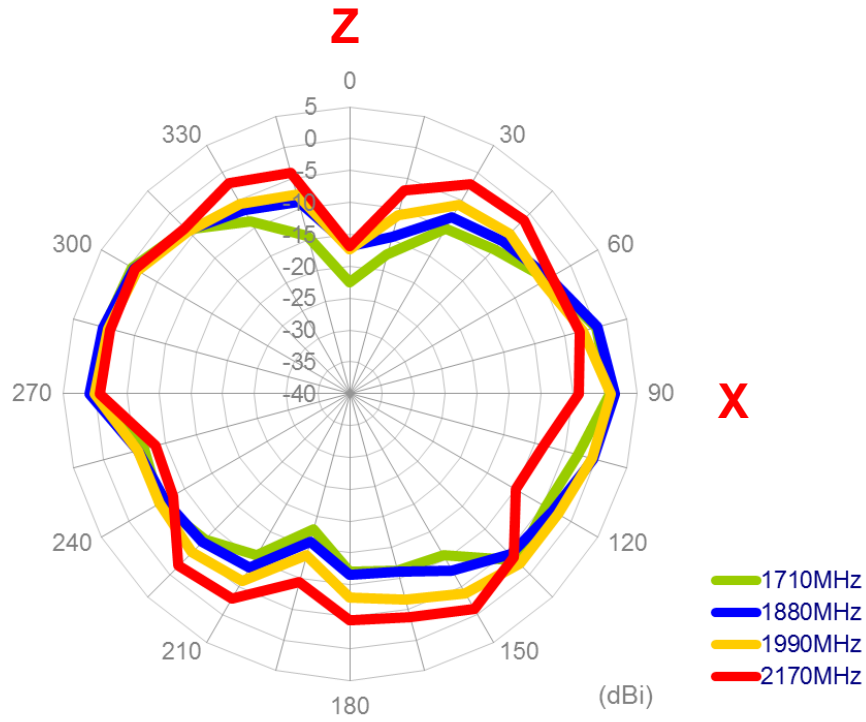

Y-Z plane

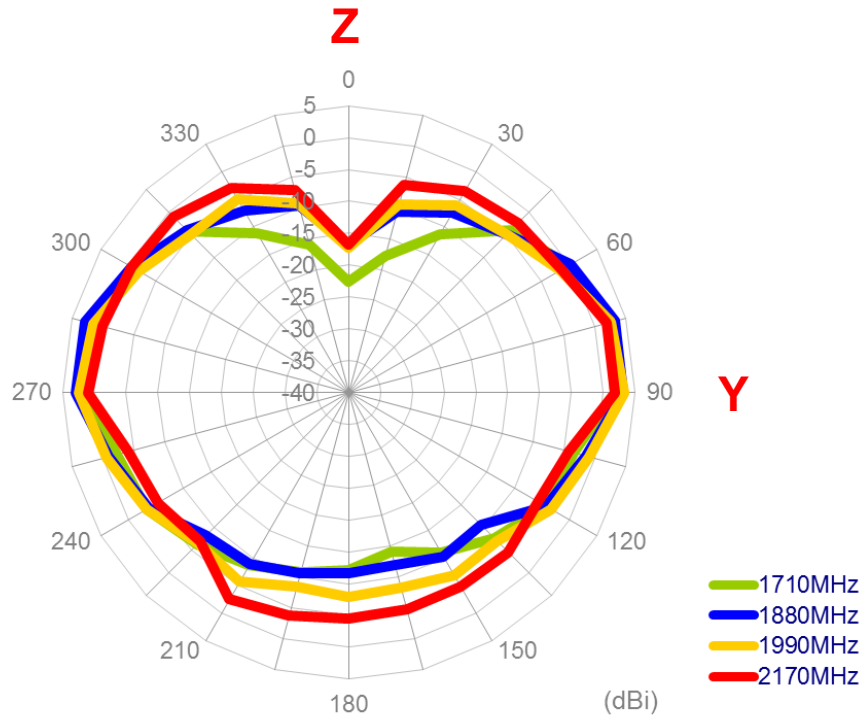

X-Y plane

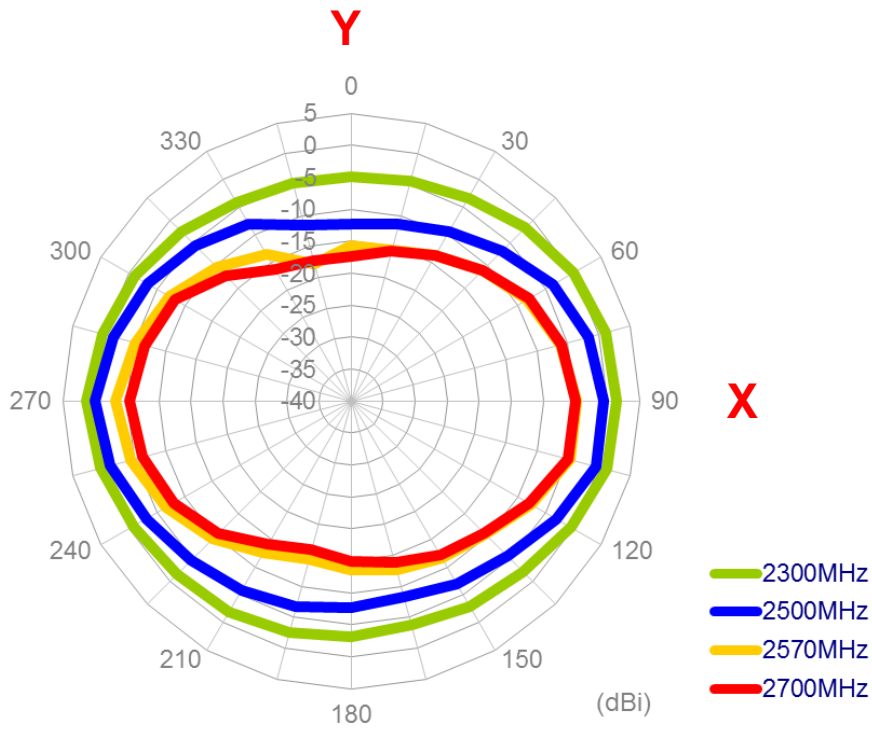

X-Z plane

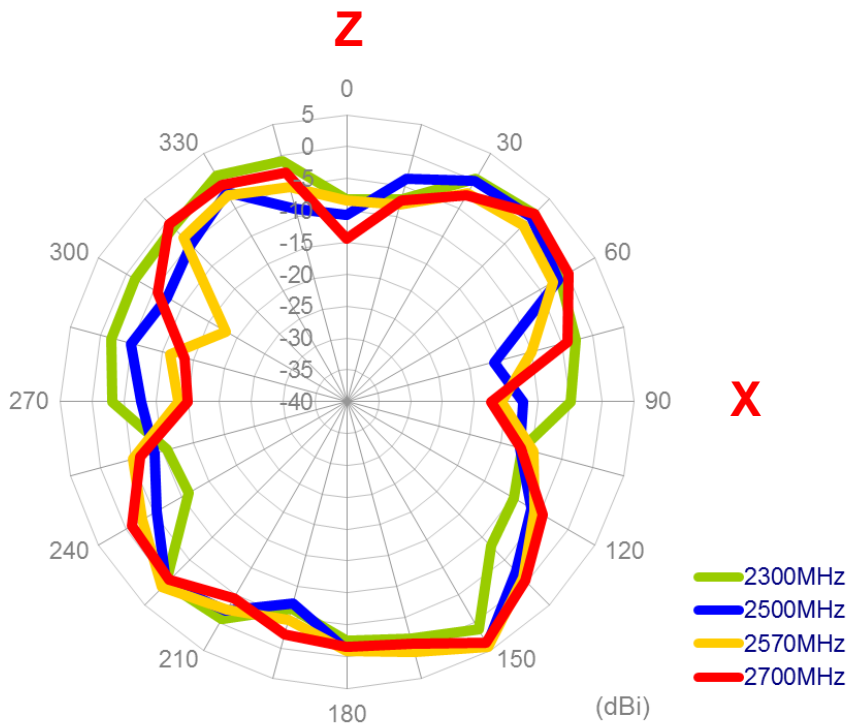

Y-Z plane

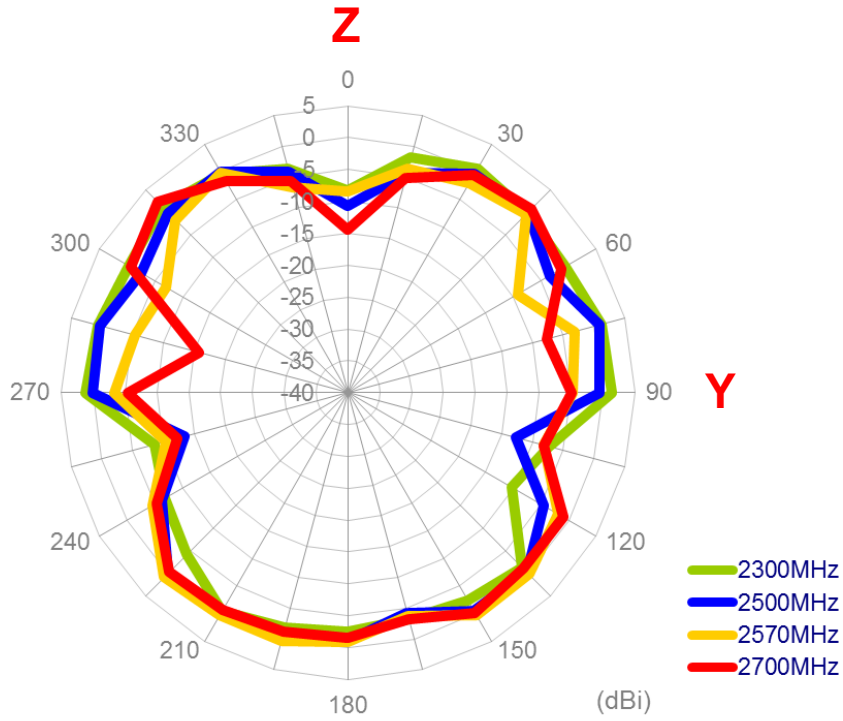

X-Y plane

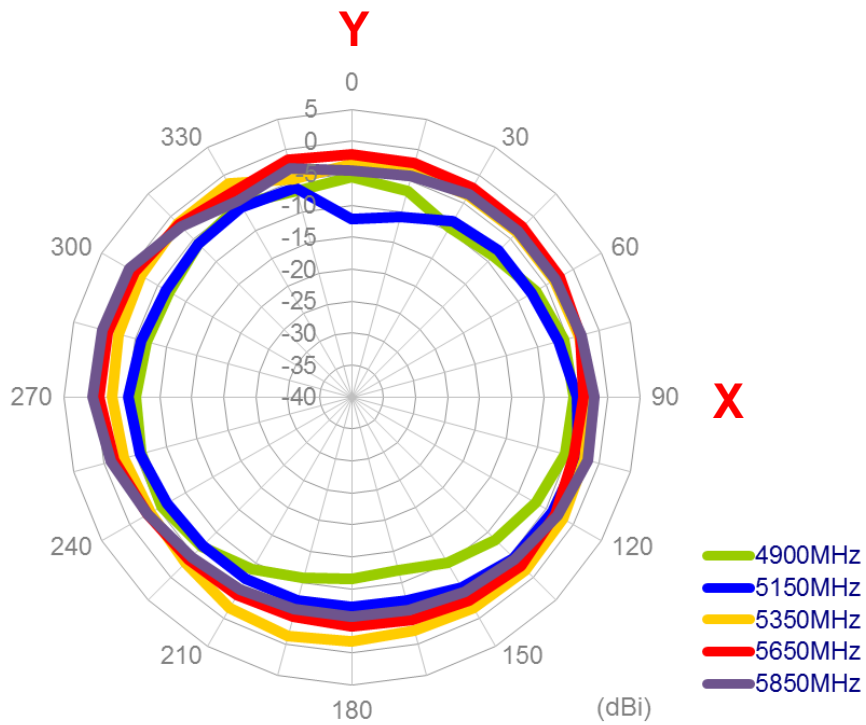

X-Z plane

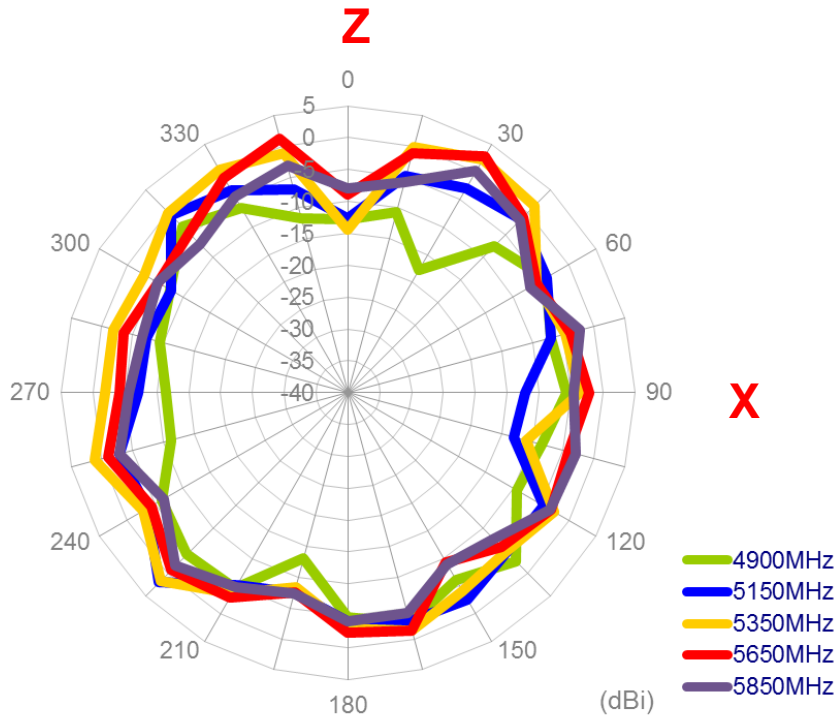

Y-Z plane

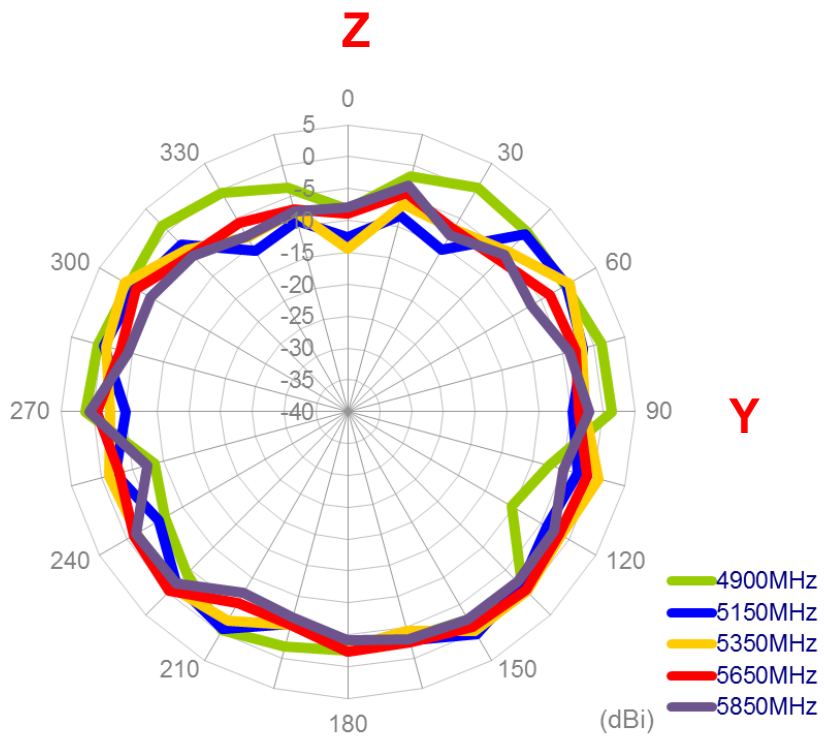

4.3 Antenna setup

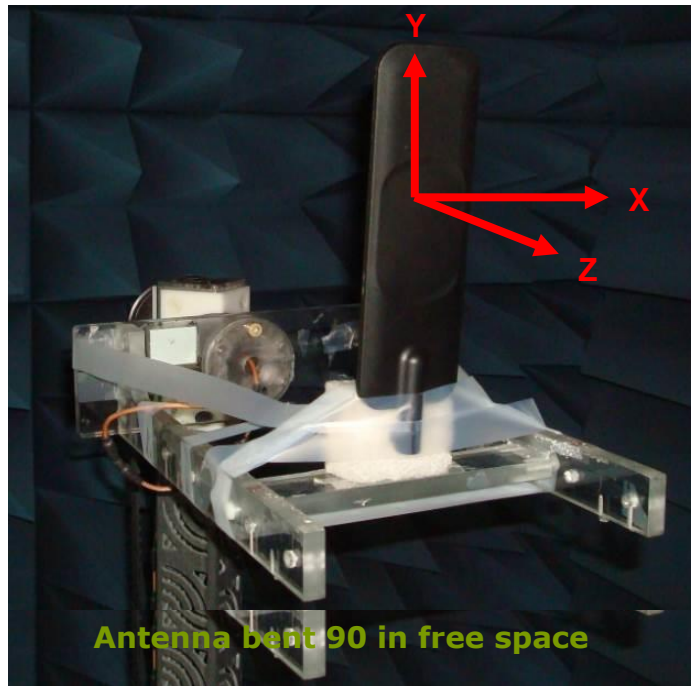

4.4 Antenna radiation patterns

4.4.1 Antenna bent 90 in free space

X-Y plane

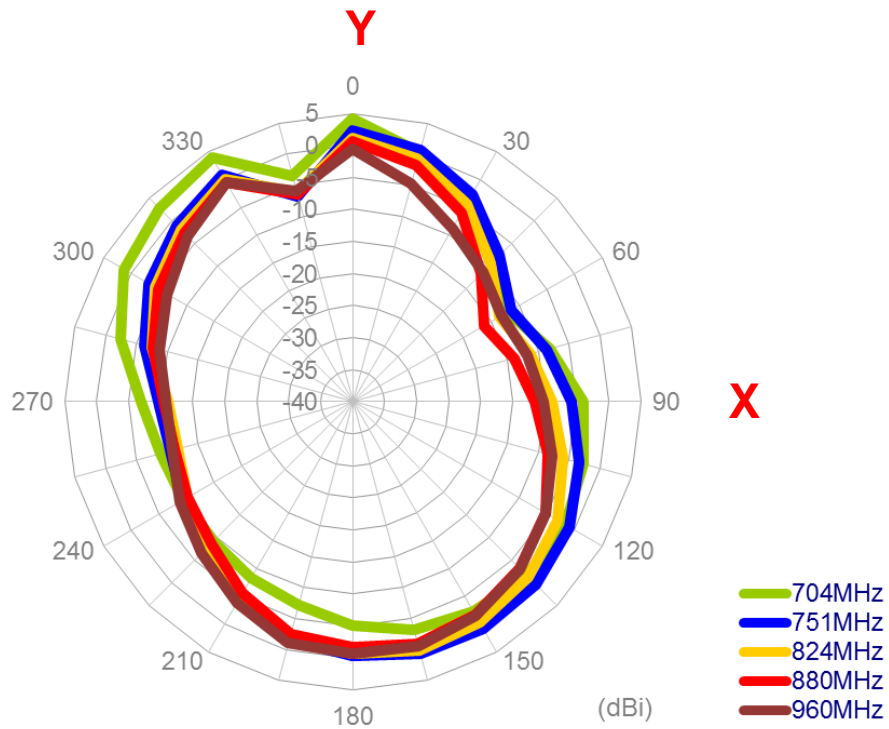

X-Z plane

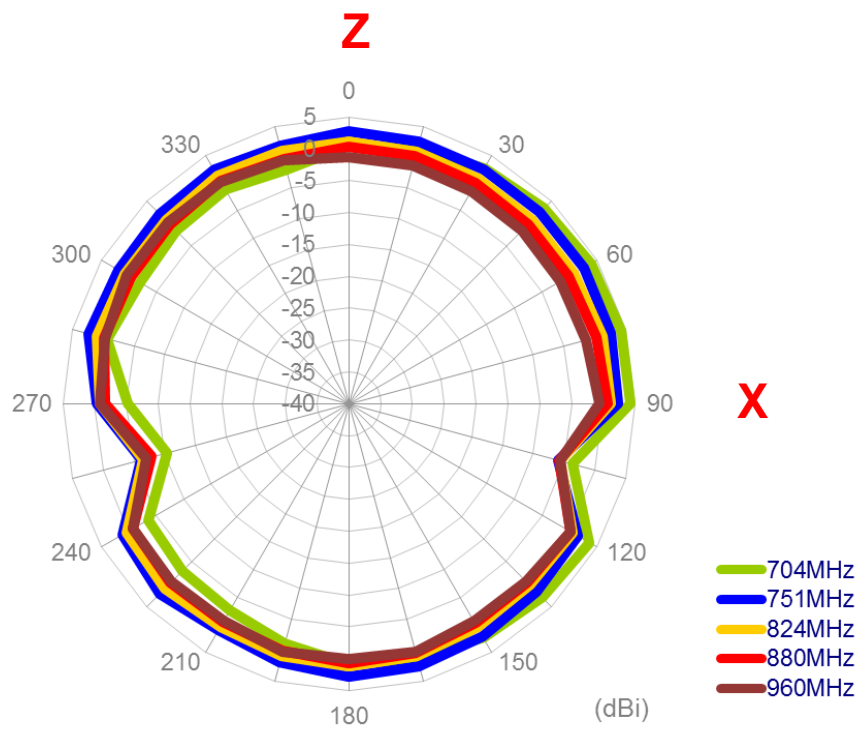

Y-Z plane

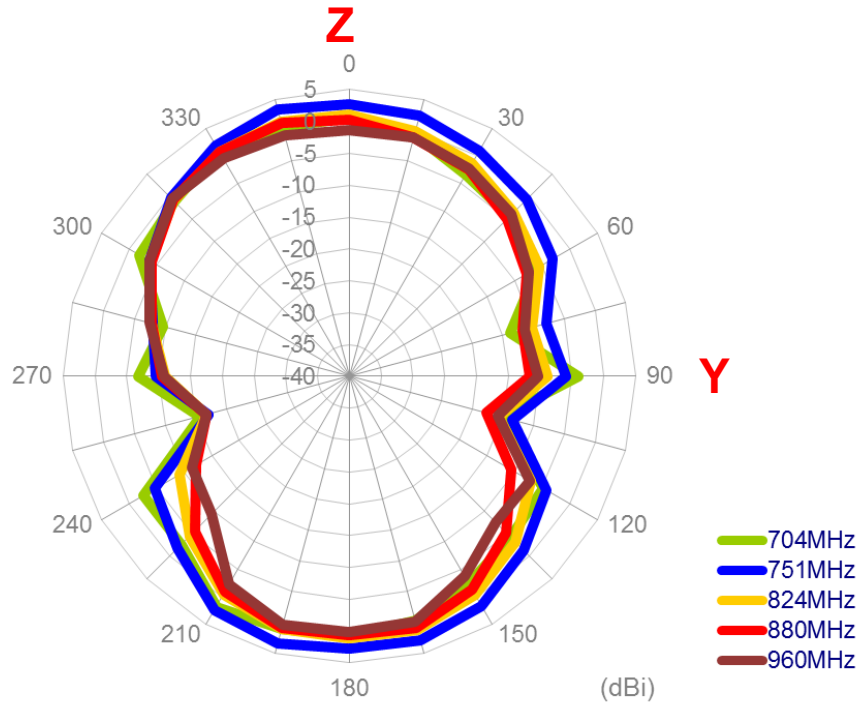

X-Y plane

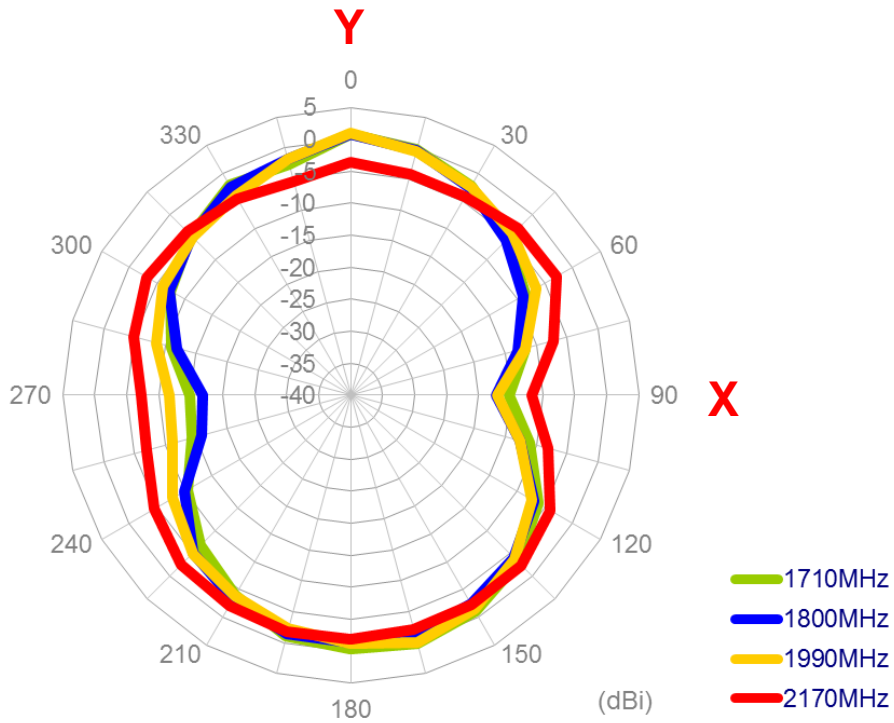

X-Z plane

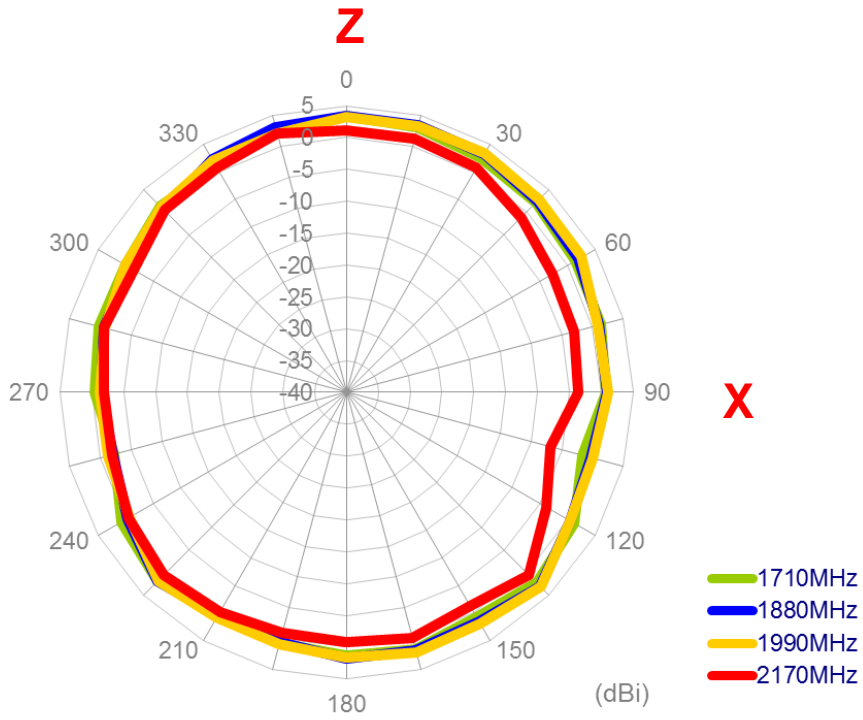

Y-Z plane

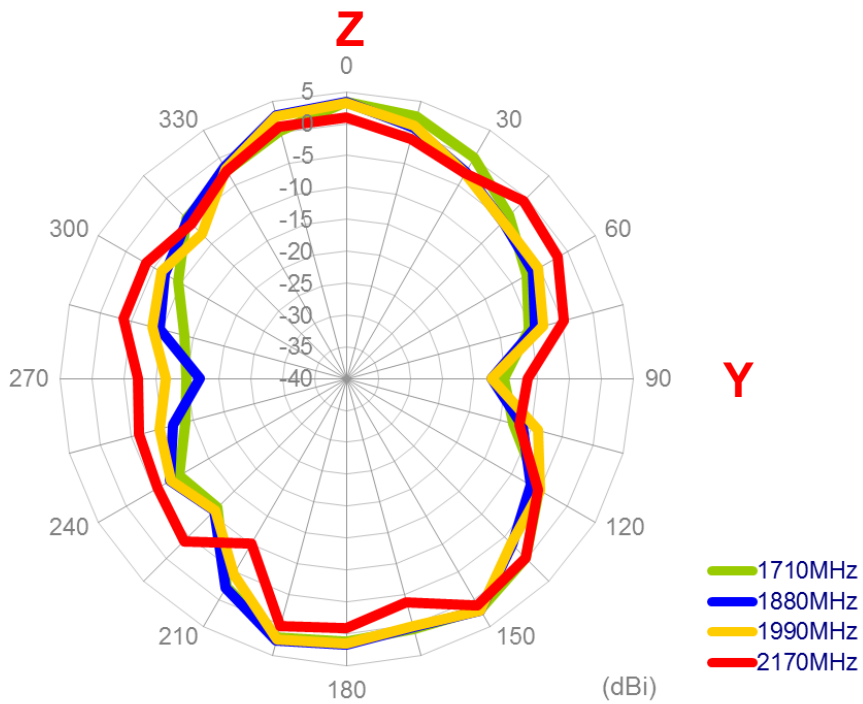

X-Y plane

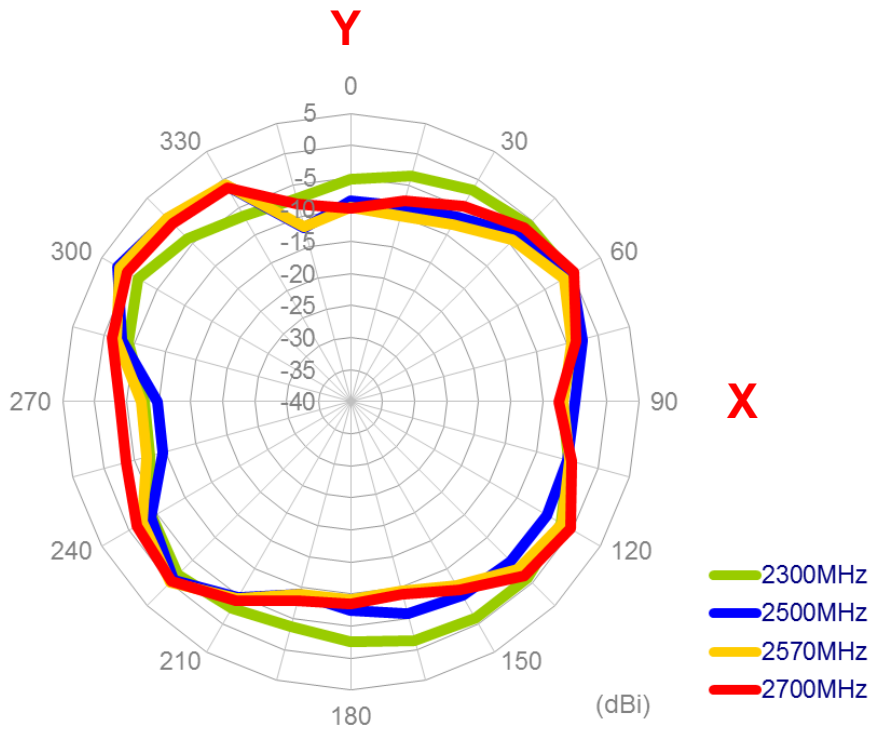

X-Z plane

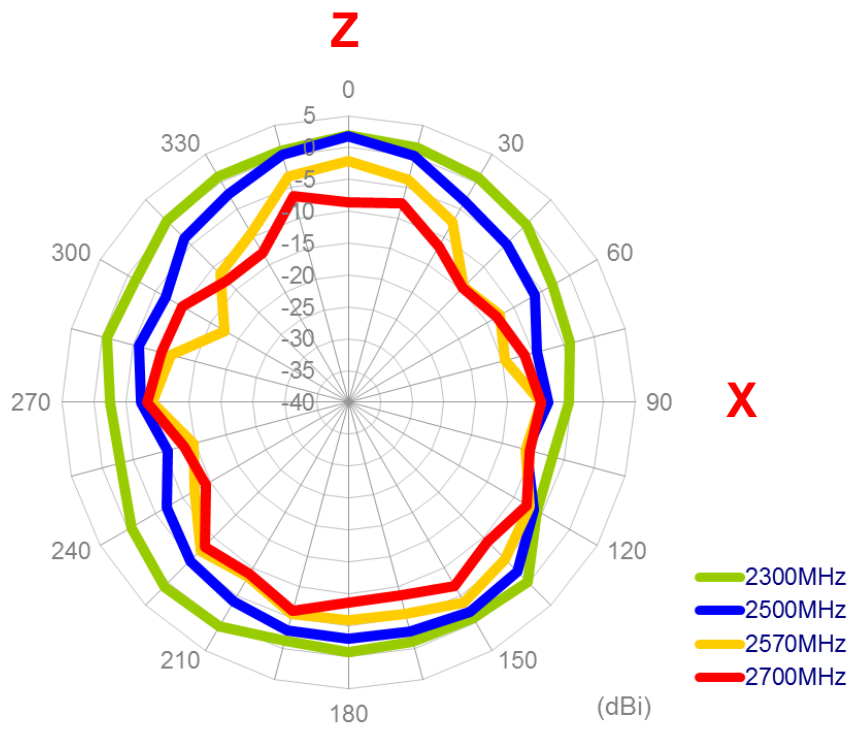

Y-Z plane

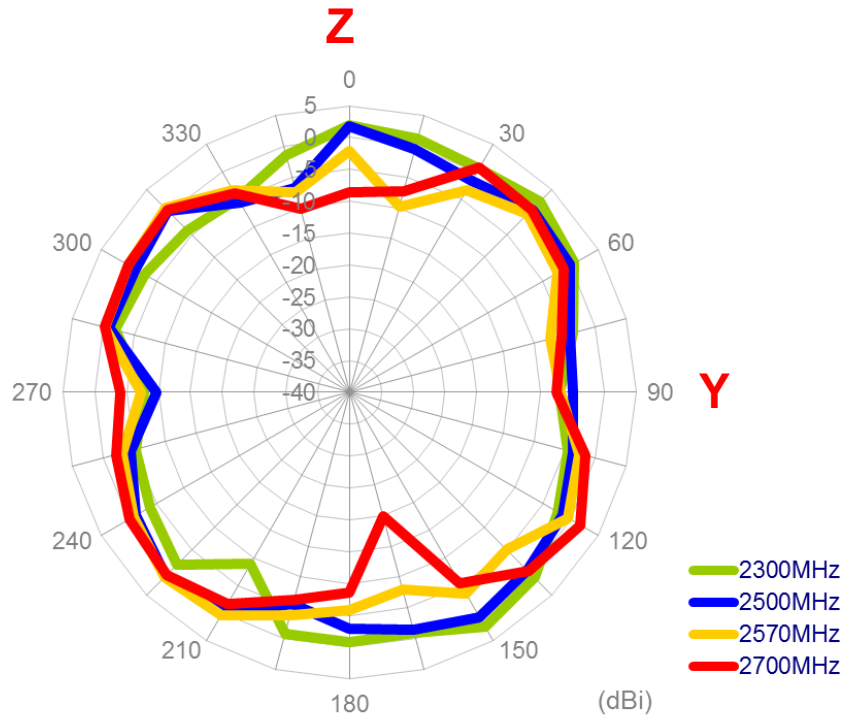

X-Y plane

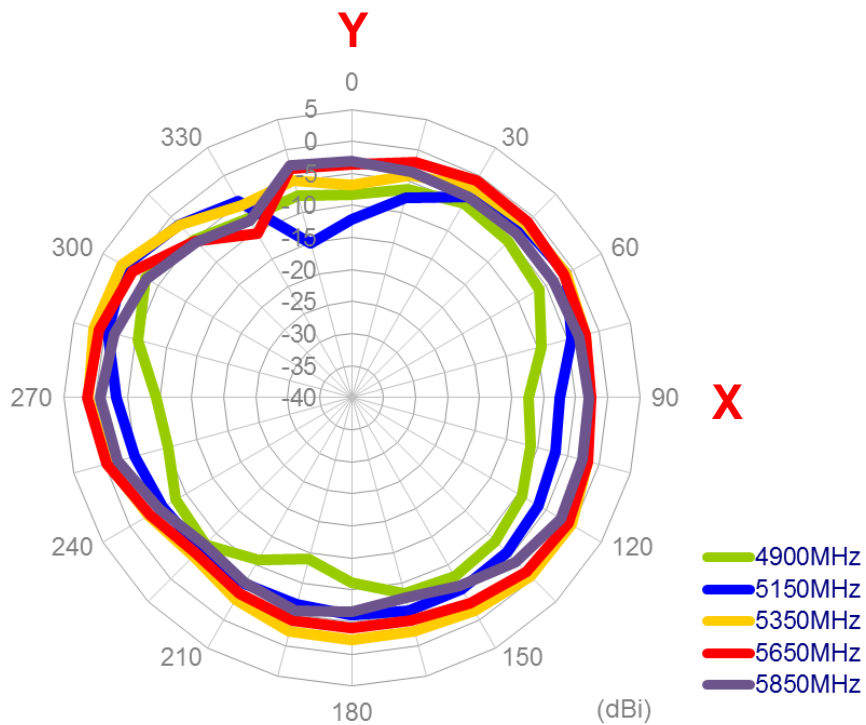

X-Z plane

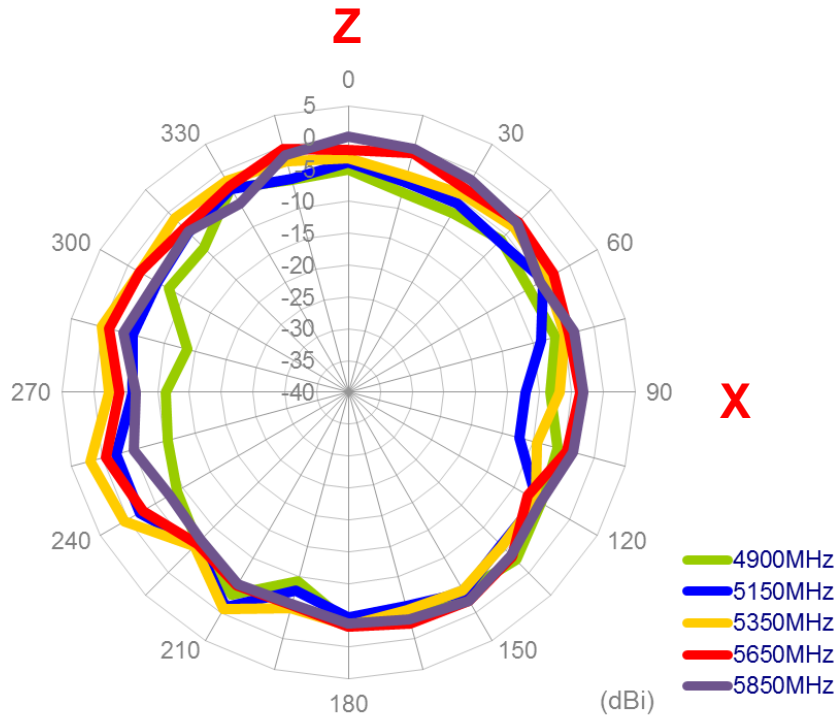

Y-Z plane

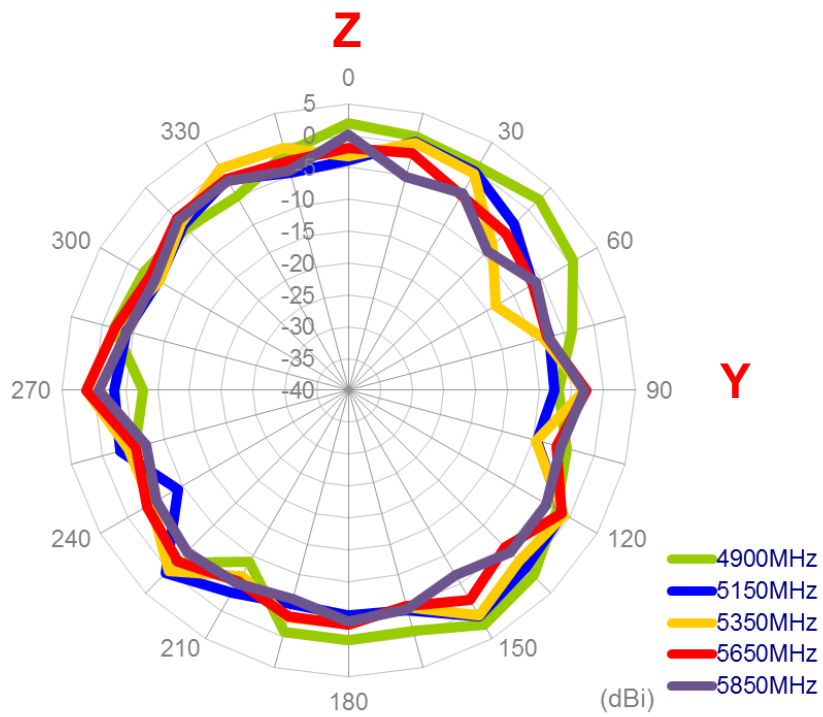

4.5 Antenna setup

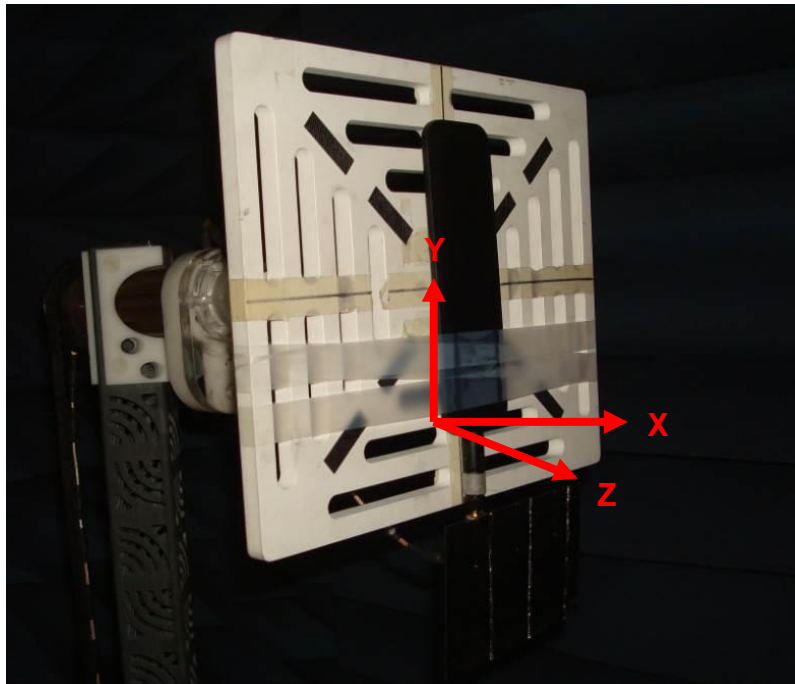

Antenna bent 90 with 90mmx150mm ground plane

4.6 Antenna radiation patterns

4.6.1 Antenna bent 90 with 90mmx150mm ground plane

X-Y plane

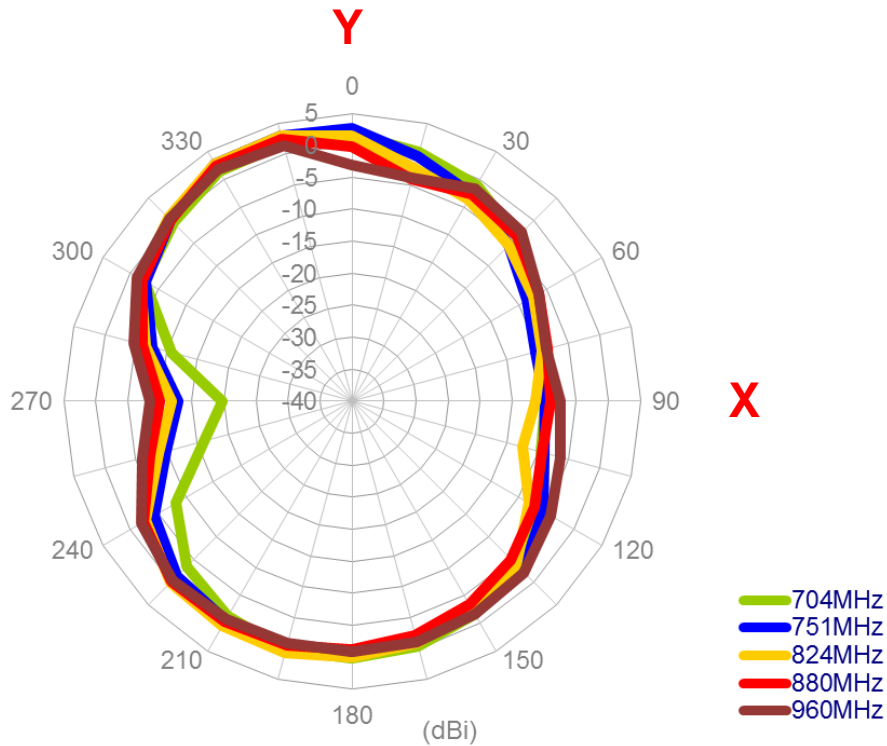

X-Z plane

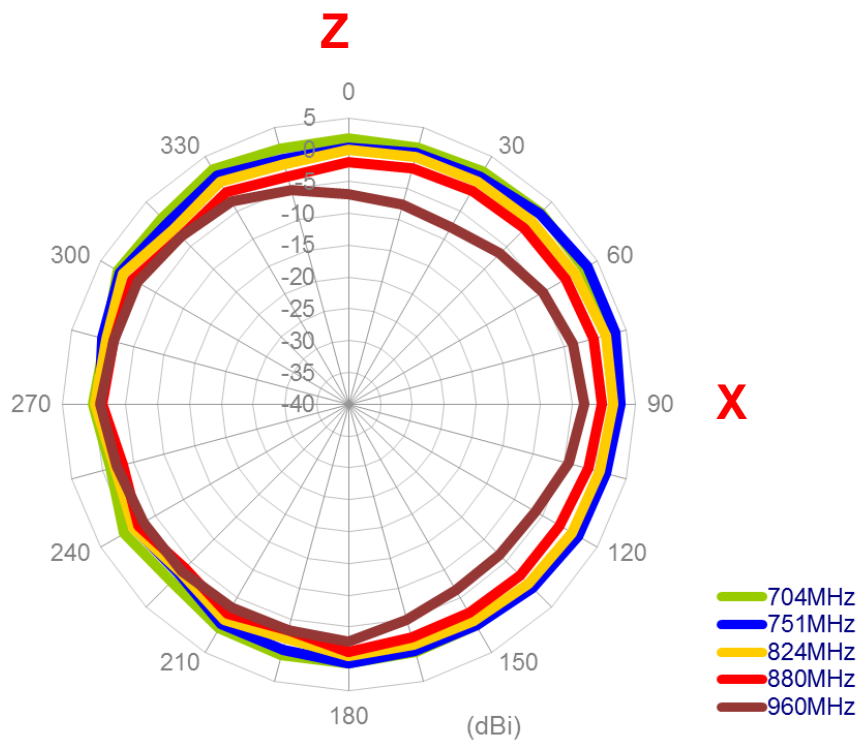

Y-Z plane

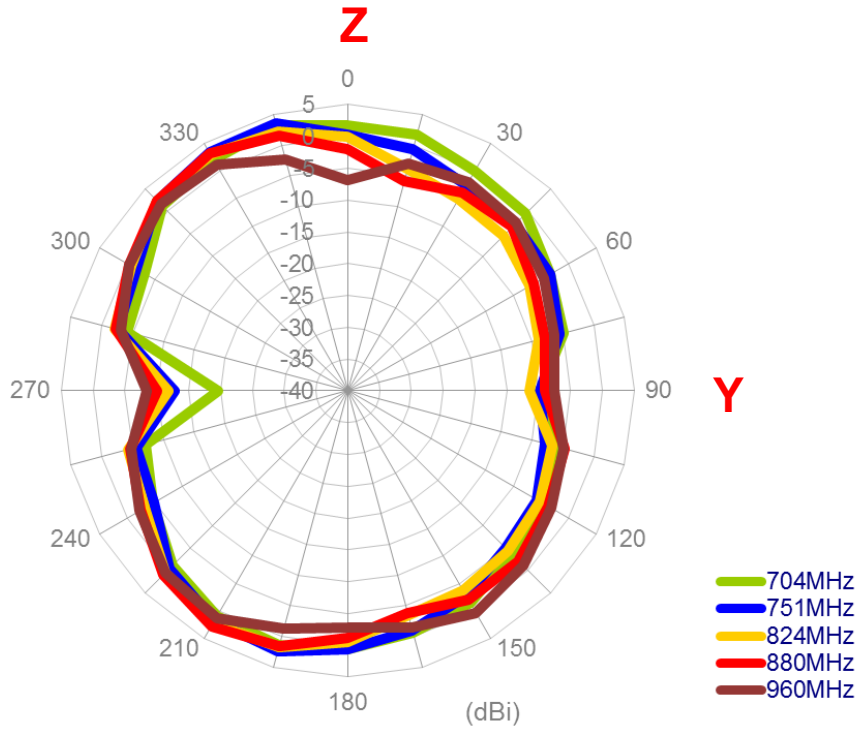

X-Y plane

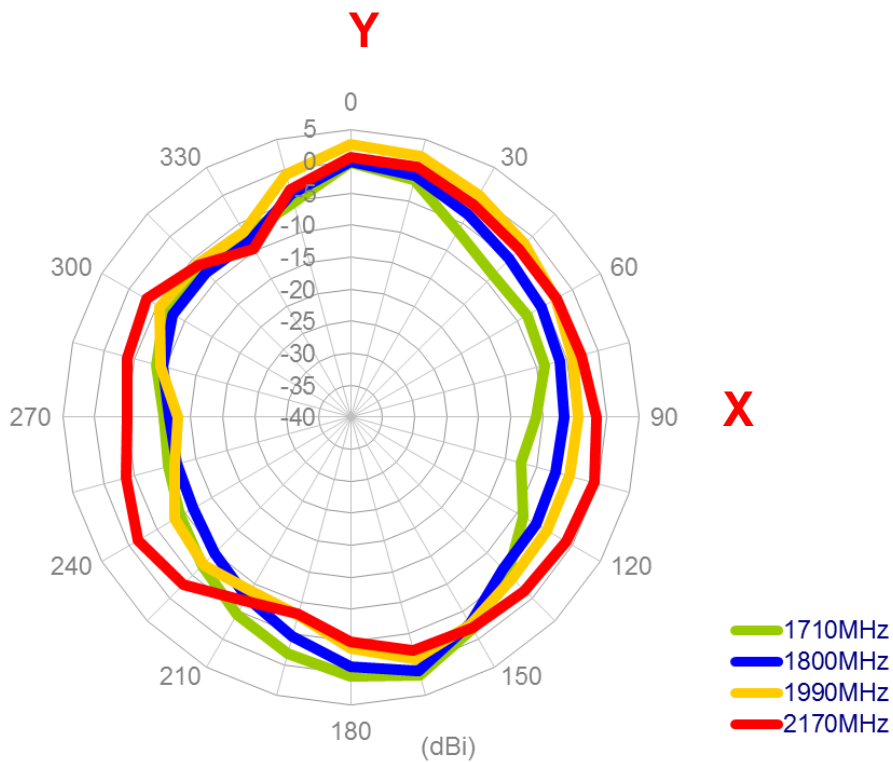

X-Z plane

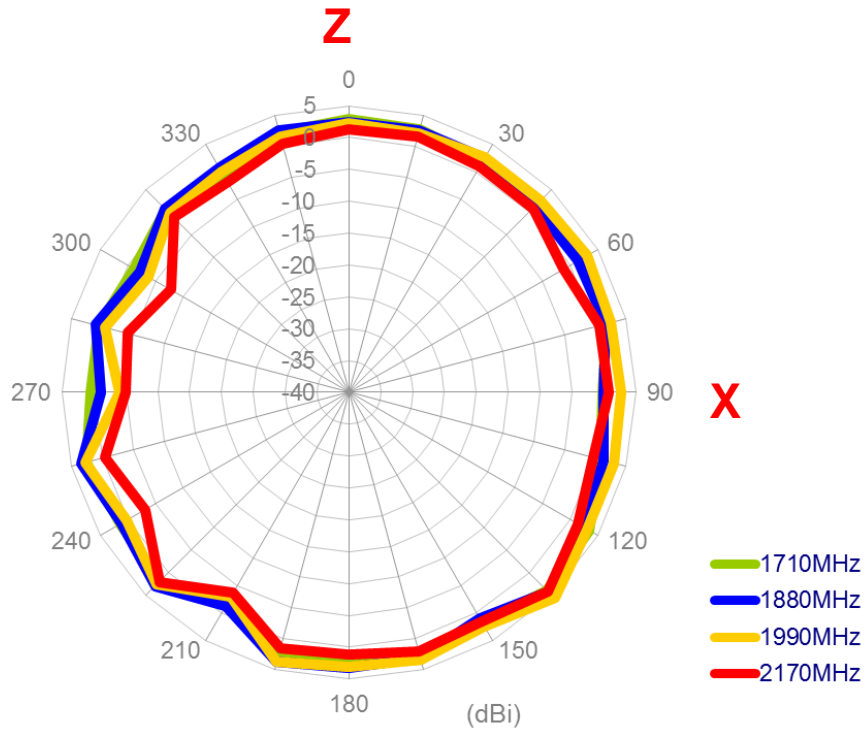

Y-Z plane

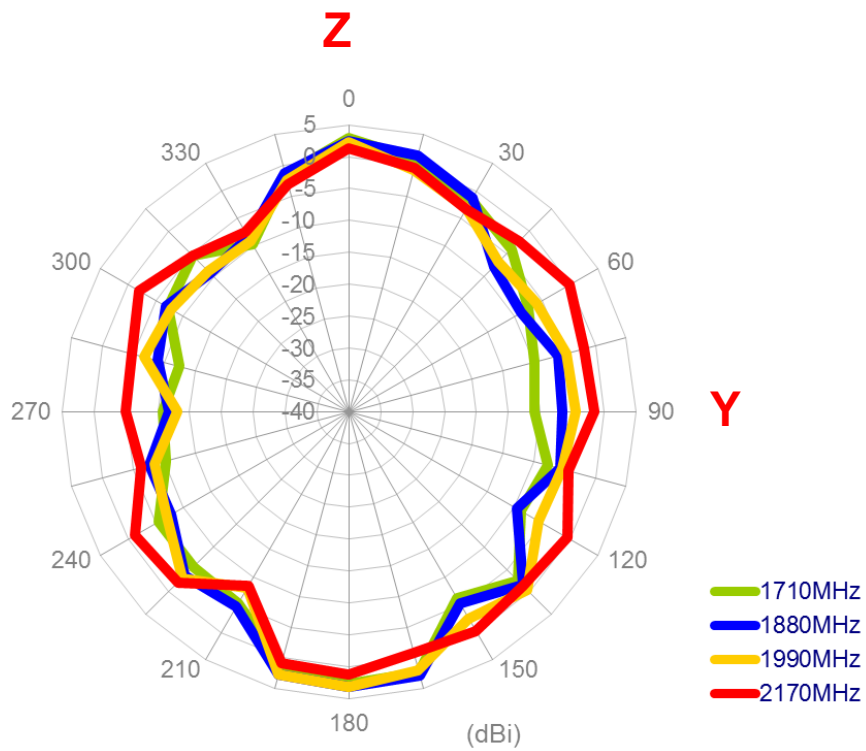

X-Y plane

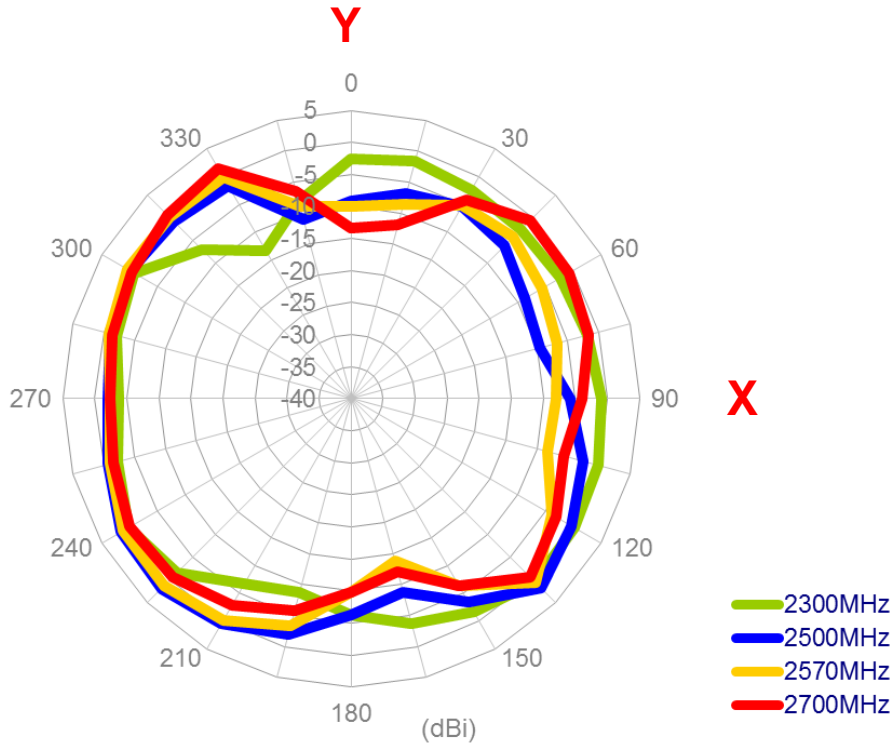

X-Z plane

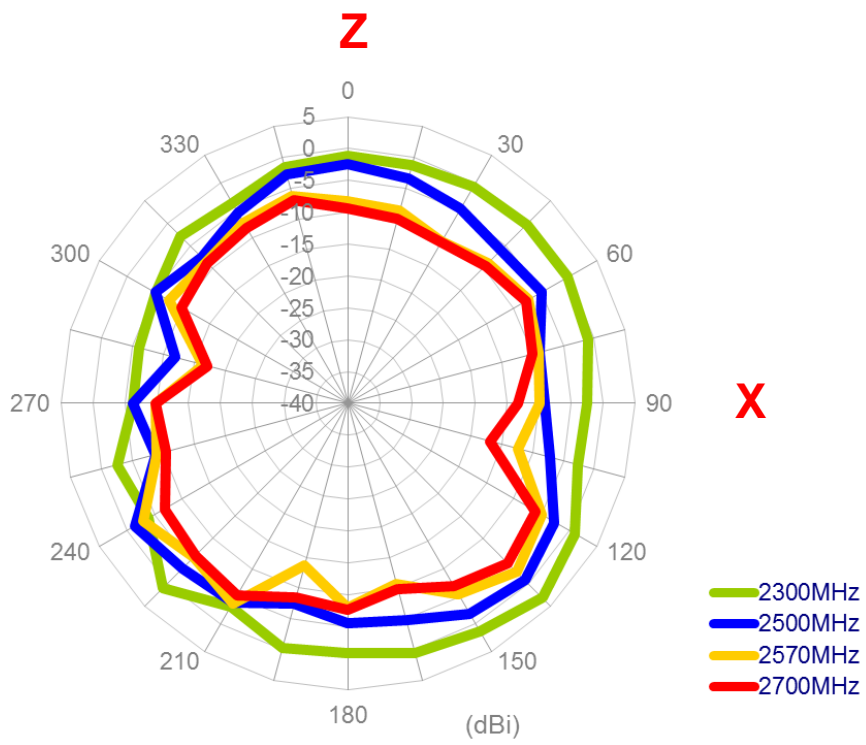

Y-Z plane

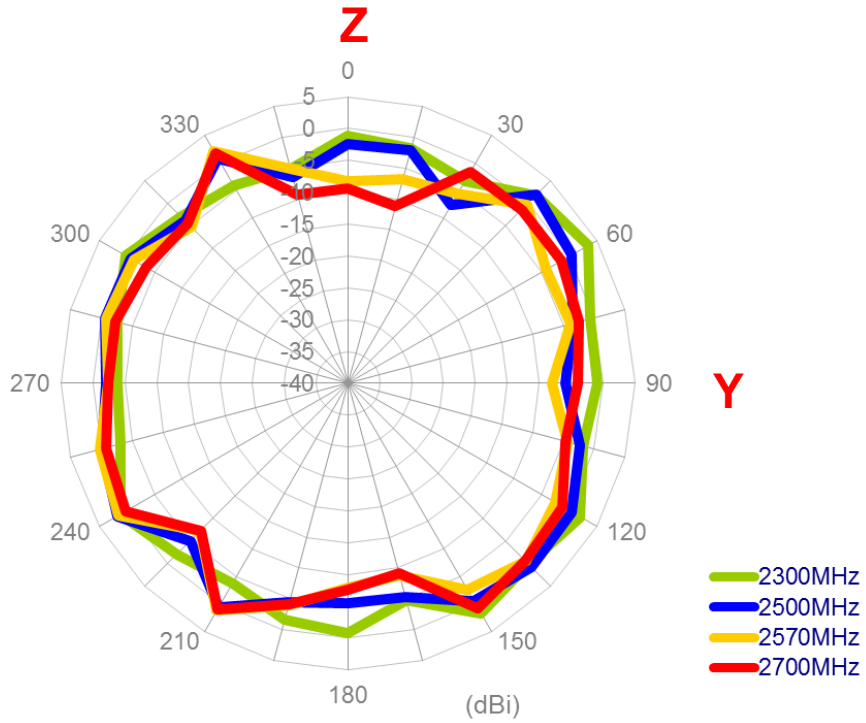

X-Y plane

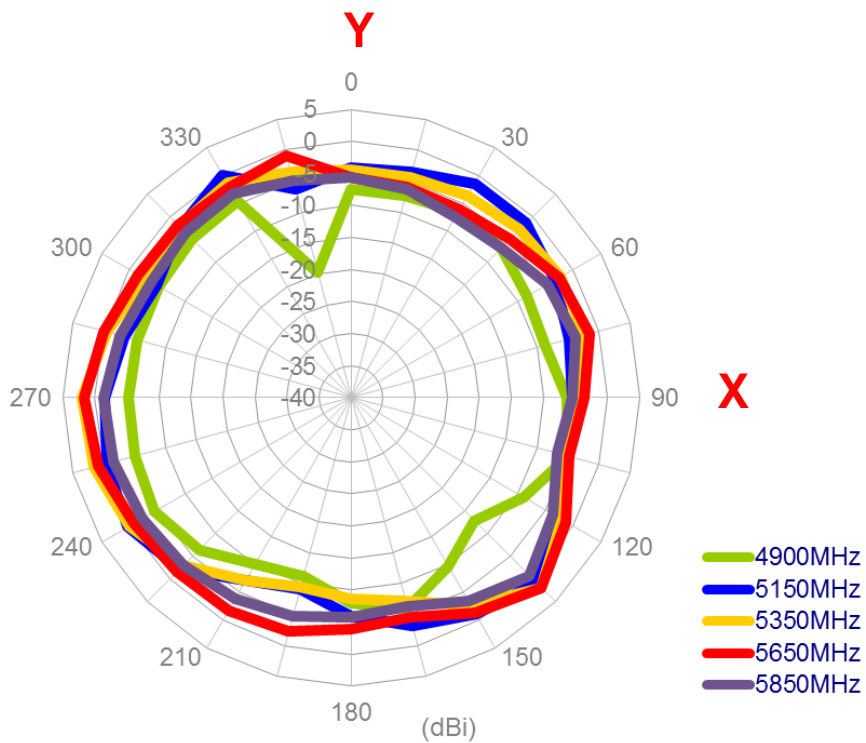

X-Z plane

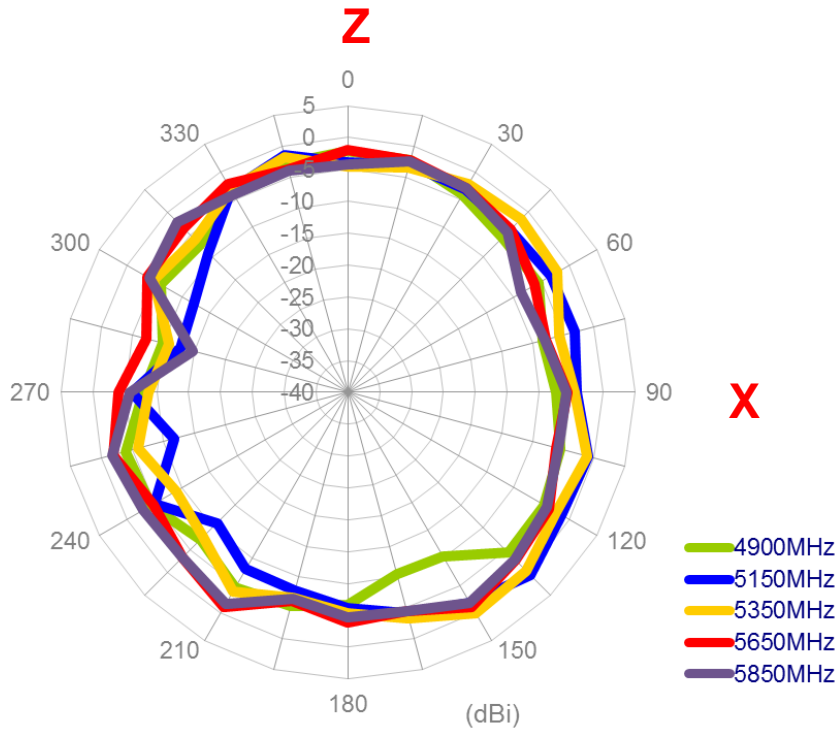

Y-Z plane

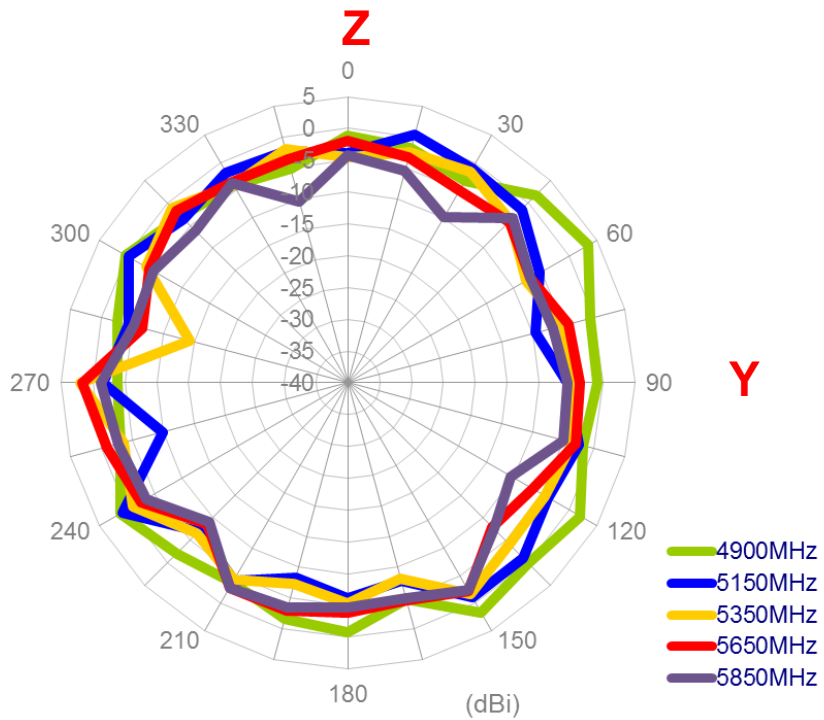

4.7 Antenna setup

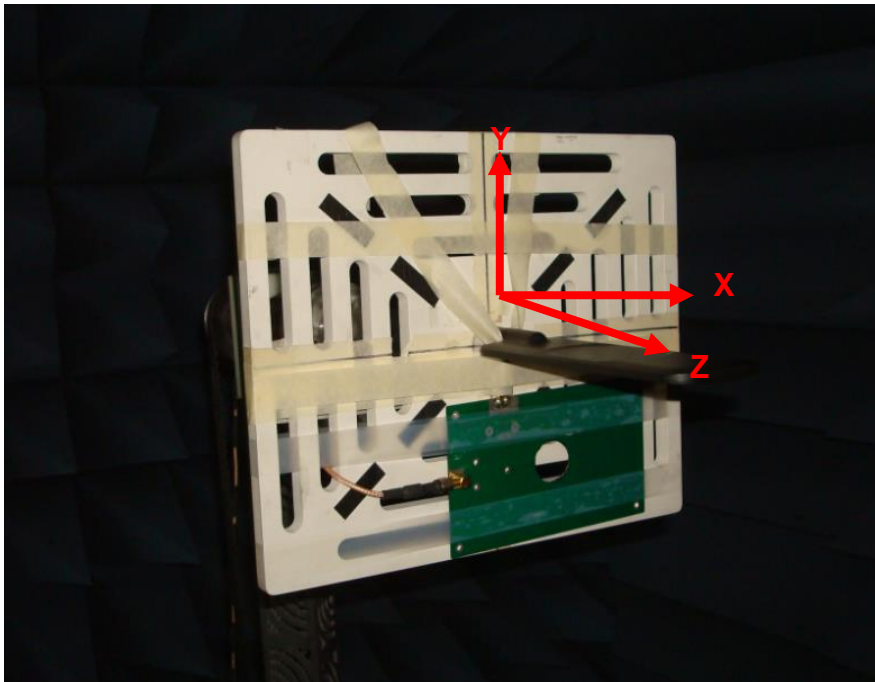

Antenna bent 90 with 90mmx150mm ground plane

4.8 Antenna radiation patterns

4.8.1 Antenna bent 90 with 90mmx150mm ground plane

X-Y plane

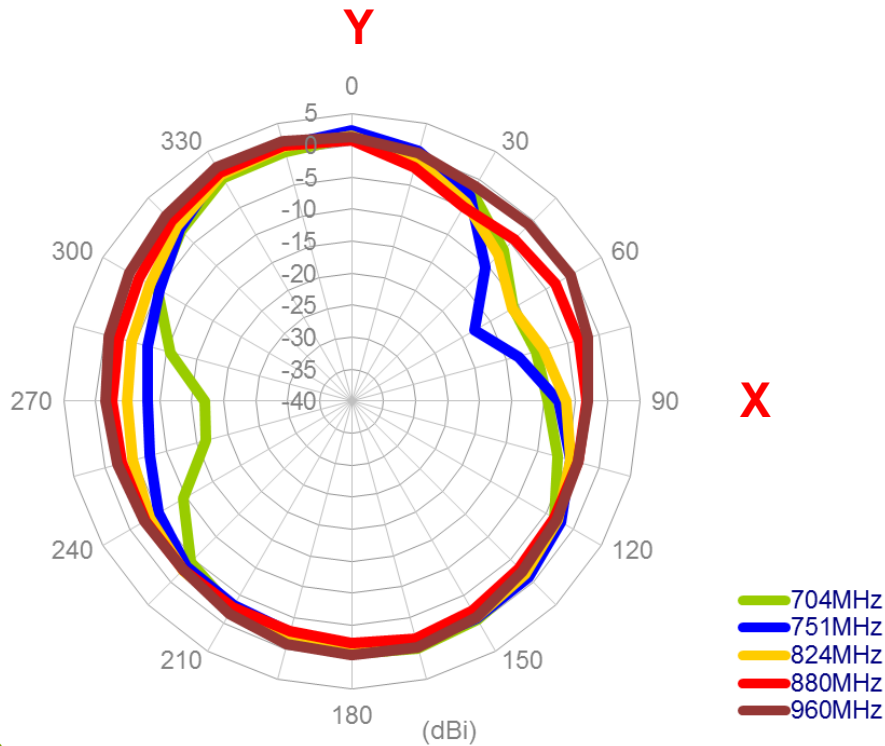

X-Z plane

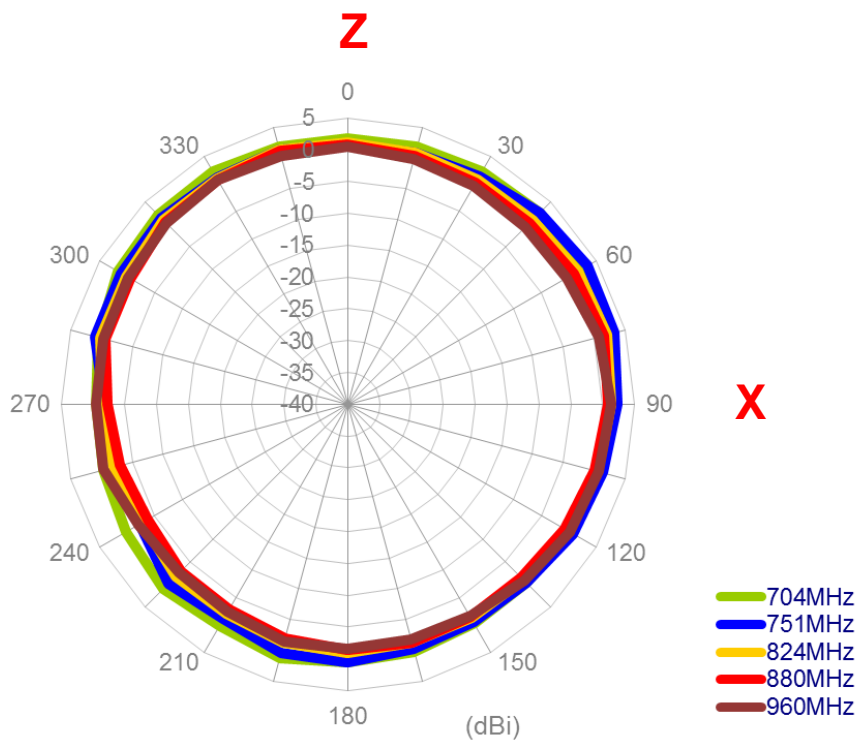

Y-Z plane

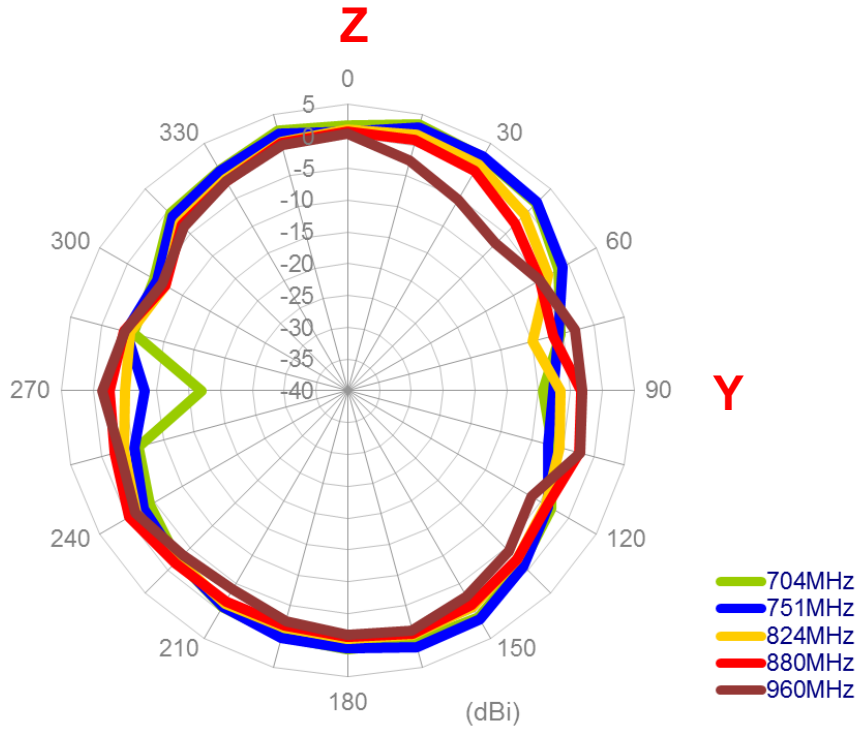

X-Y plane

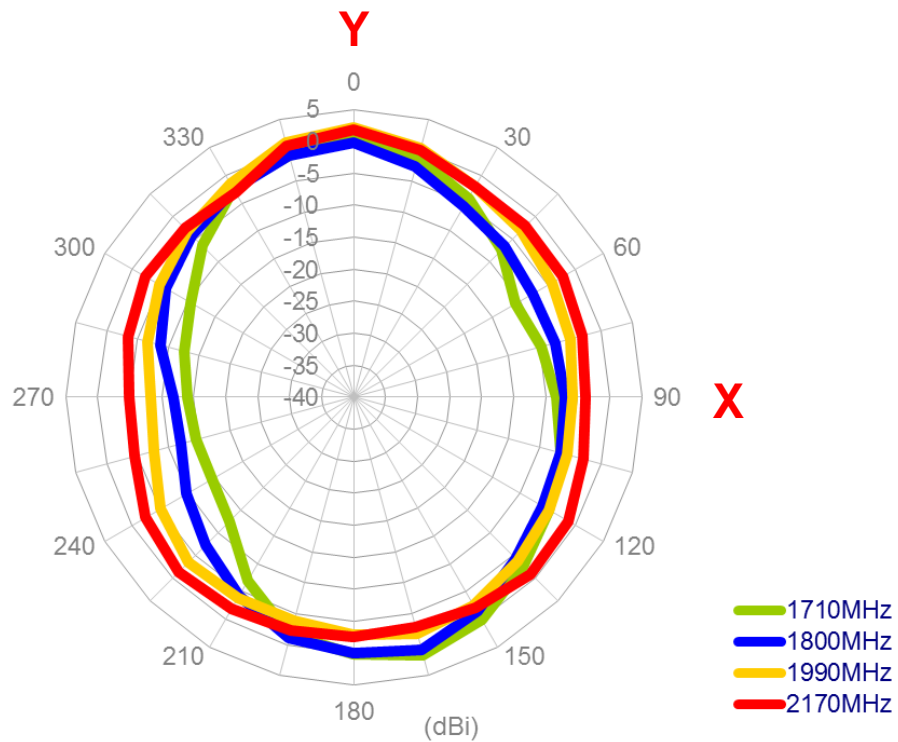

X-Z plane

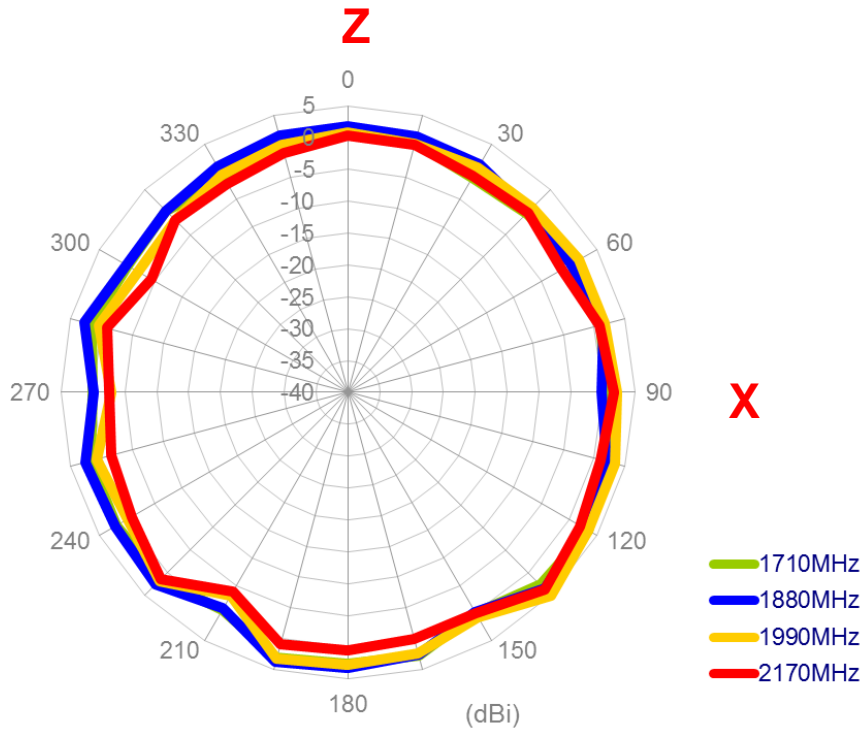

Y-Z plane

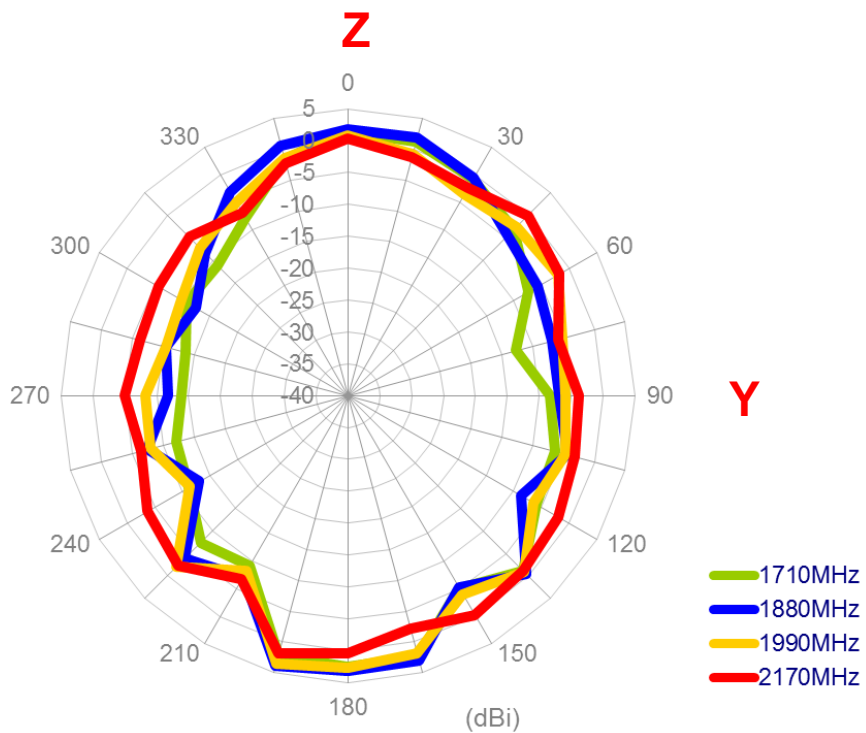

X-Y plane

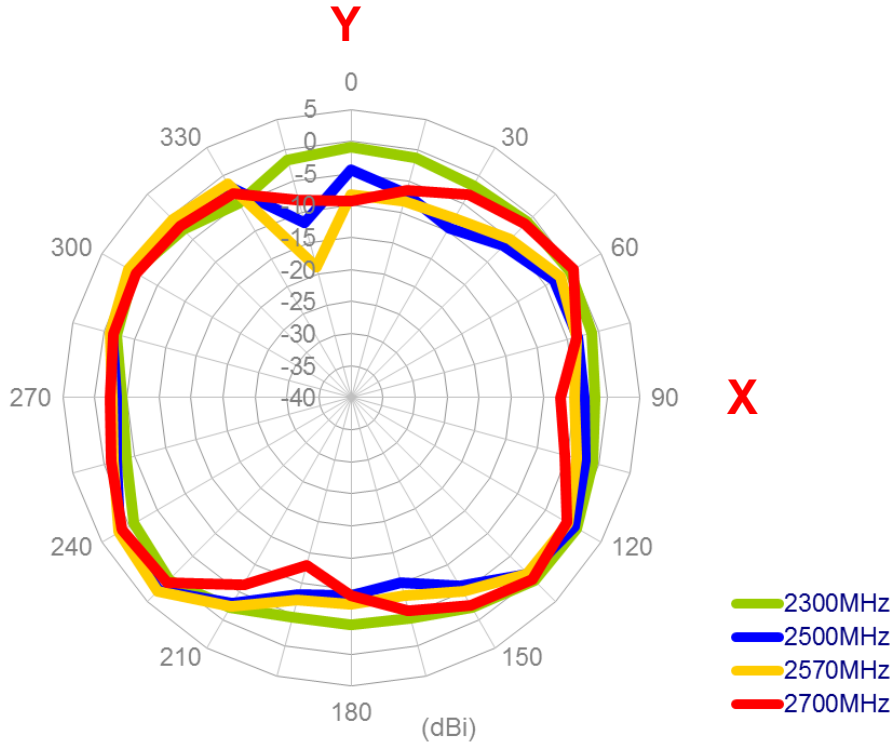

X-Z plane

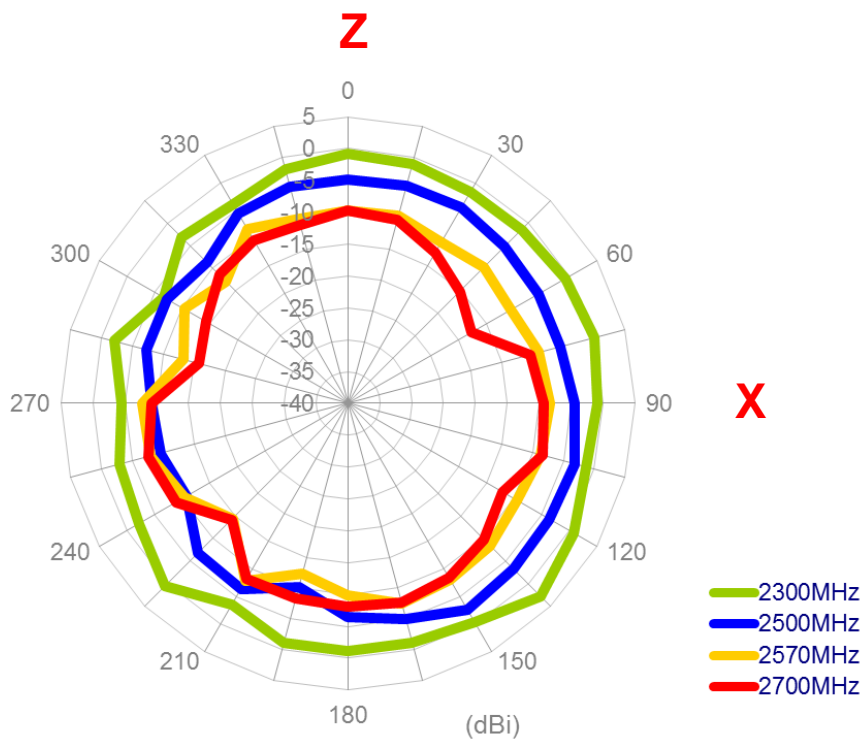

Y-Z plane

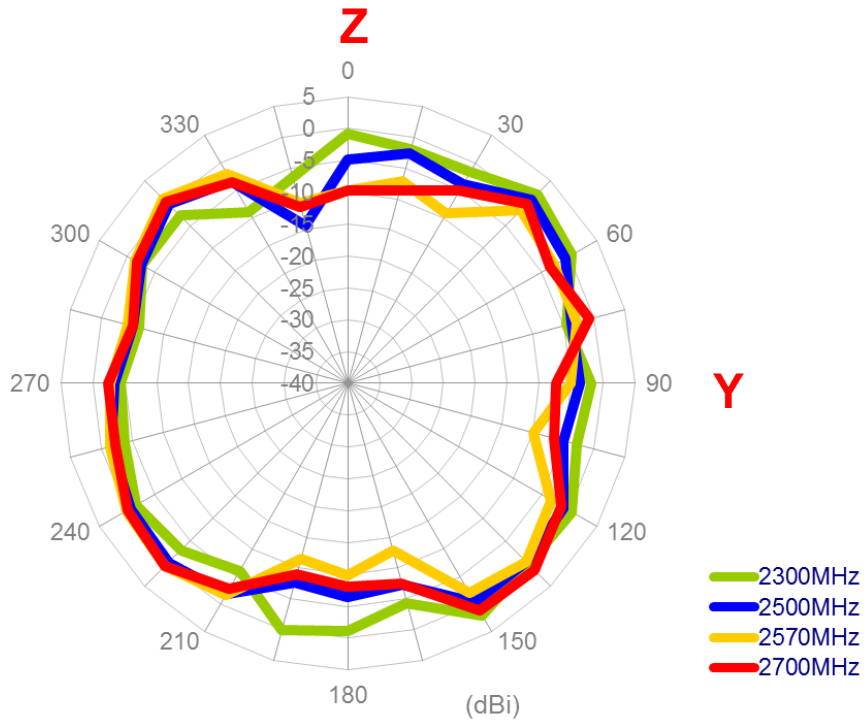

X-Y plane

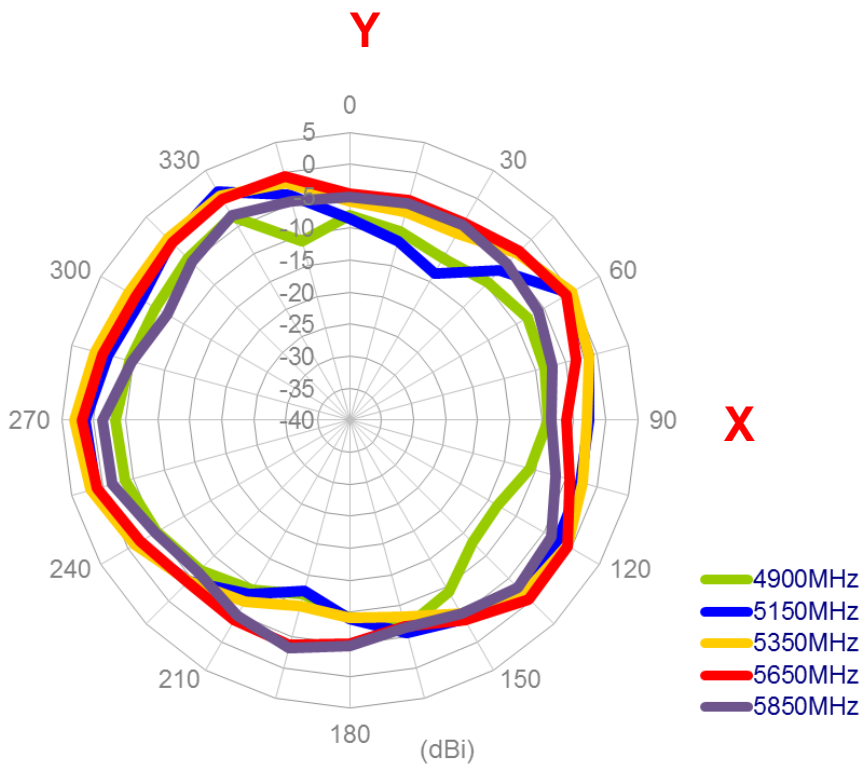

X-Z plane

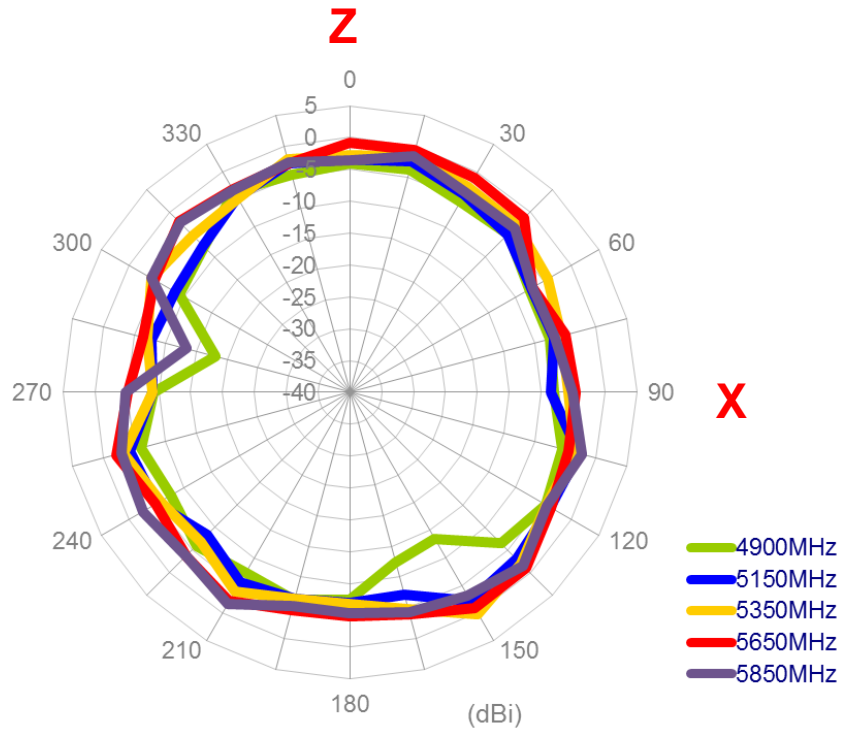

Y-Z plane

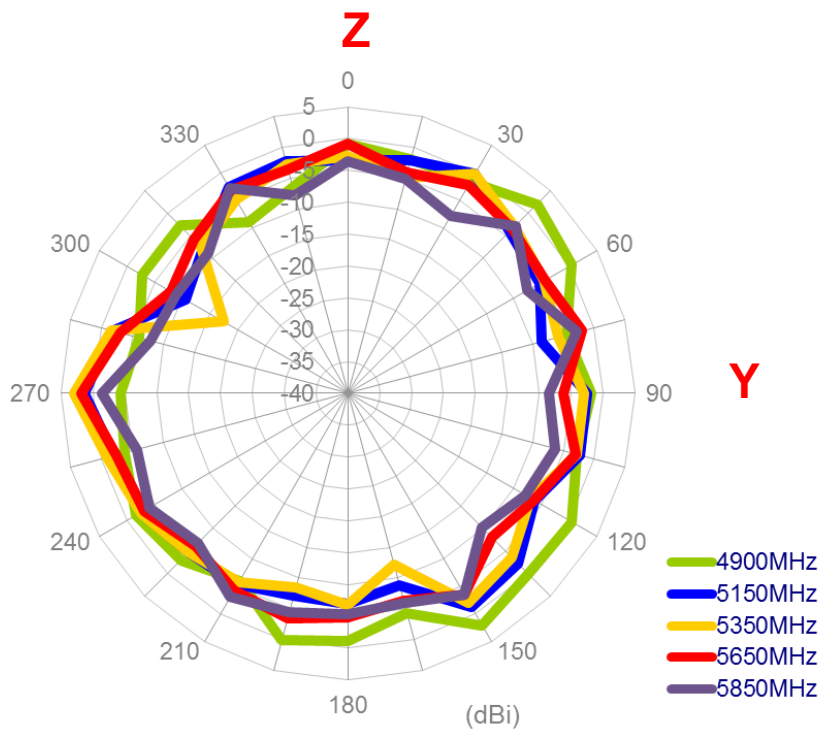

4.9 Antenna setup

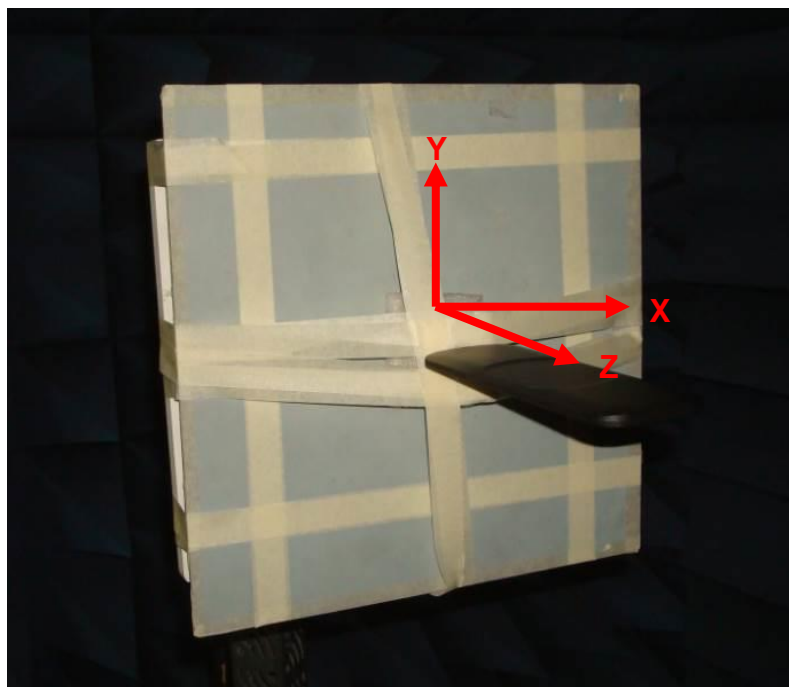

Antenna straight with 30x30cm ground plane center

4.10 Antenna radiation patterns

4.10.1 Antenna straight with 30x30cm ground plane center

X-Y plane

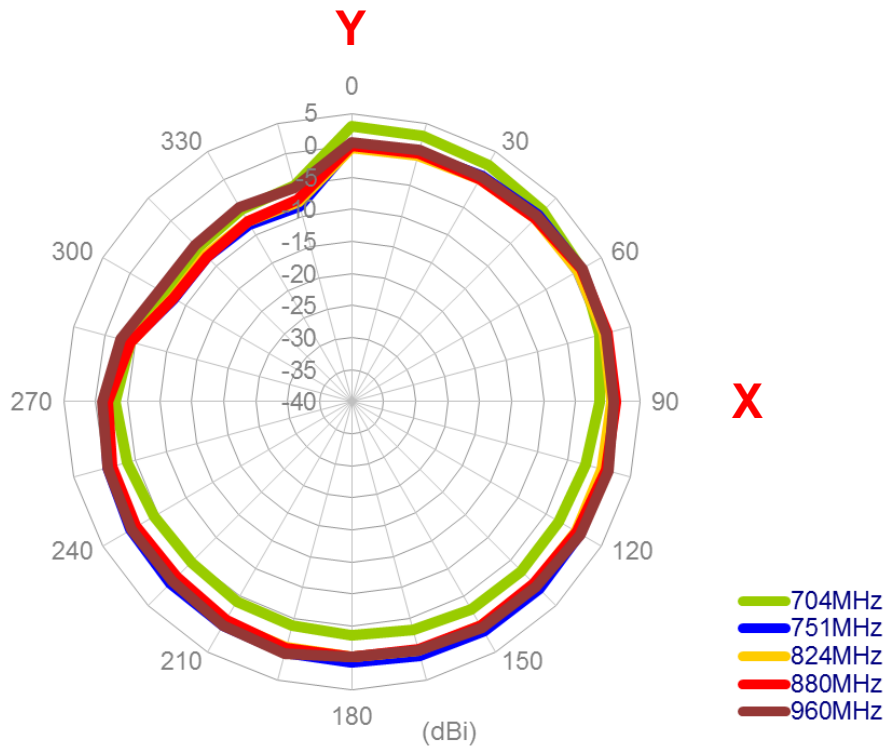

X-Z plane

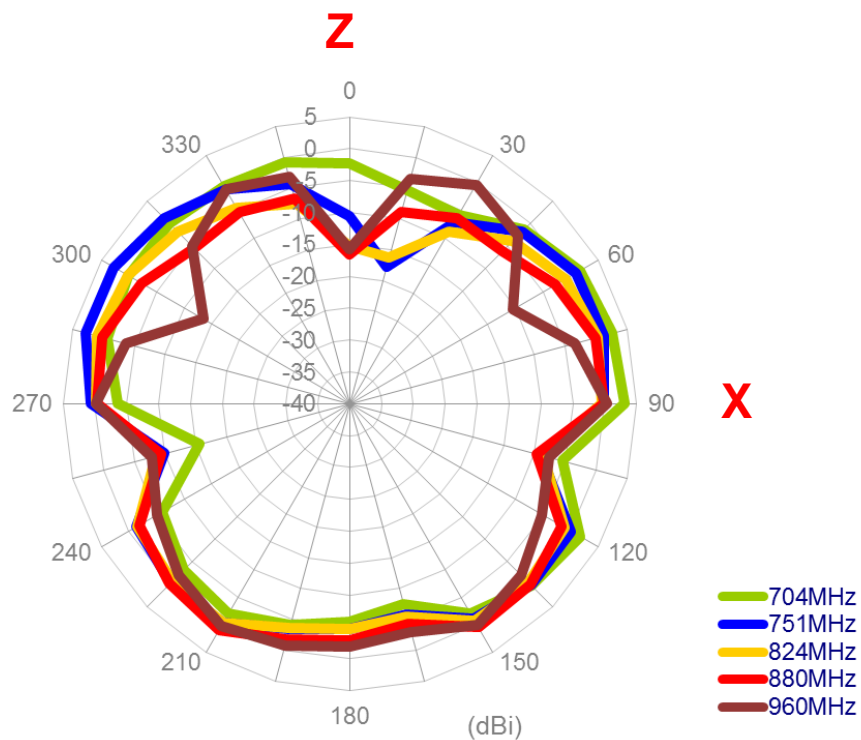

Y-Z plane

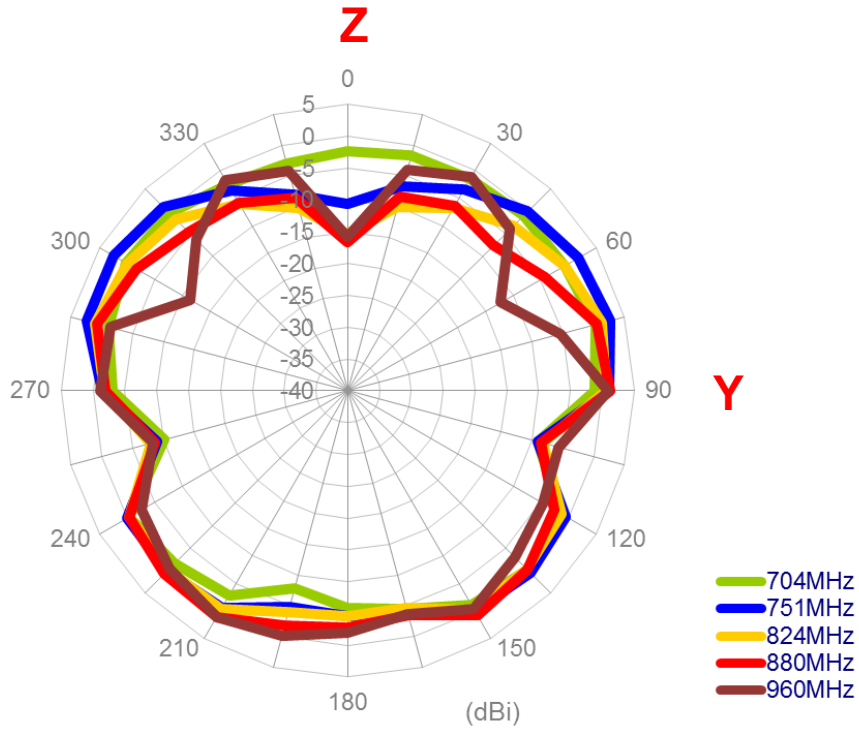

X-Y plane

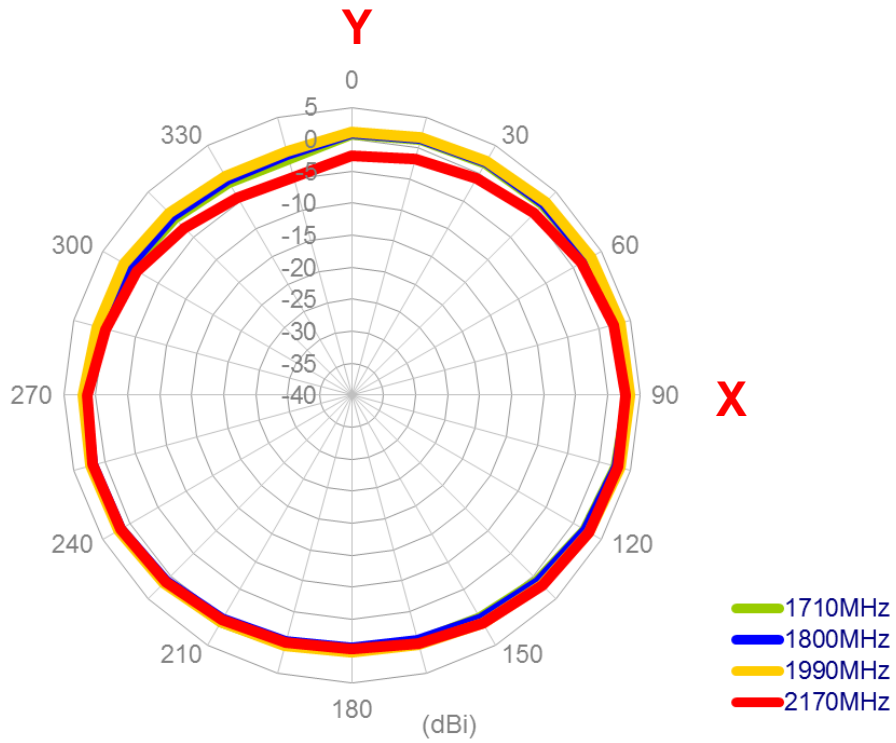

X-Z plane

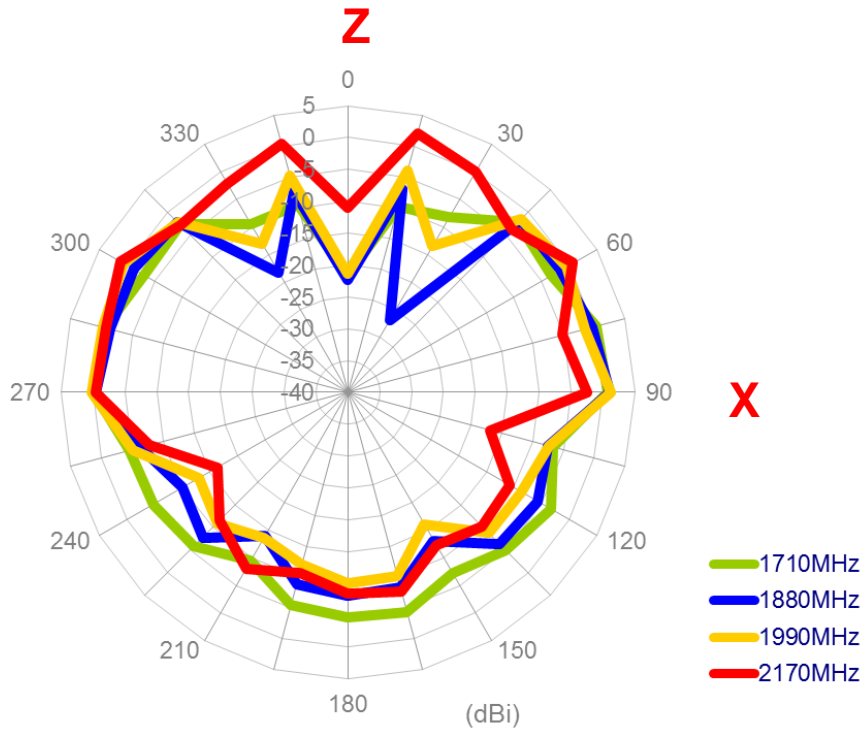

Y-Z plane

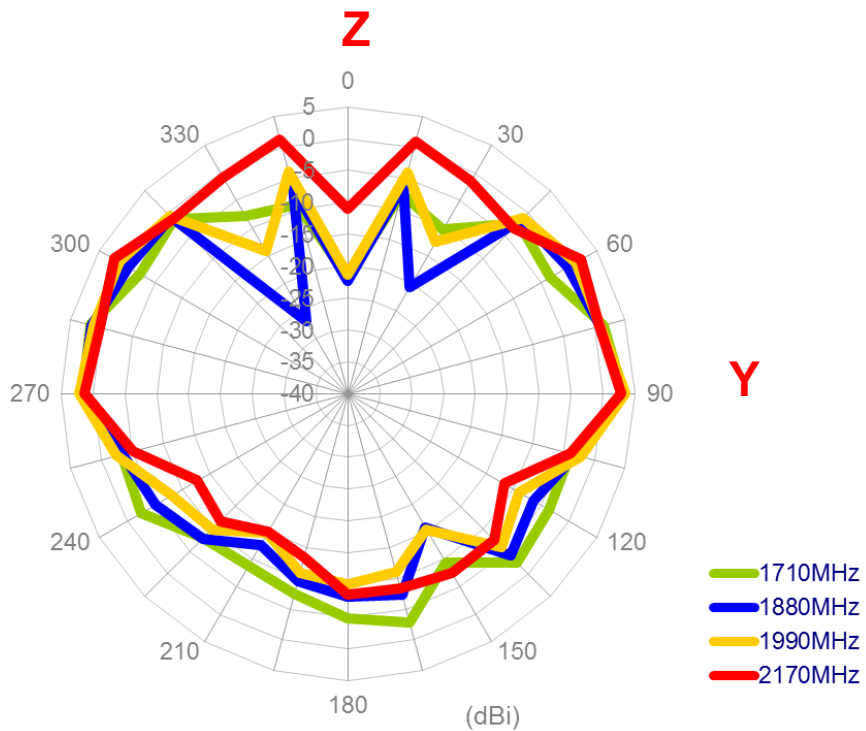

X-Y plane

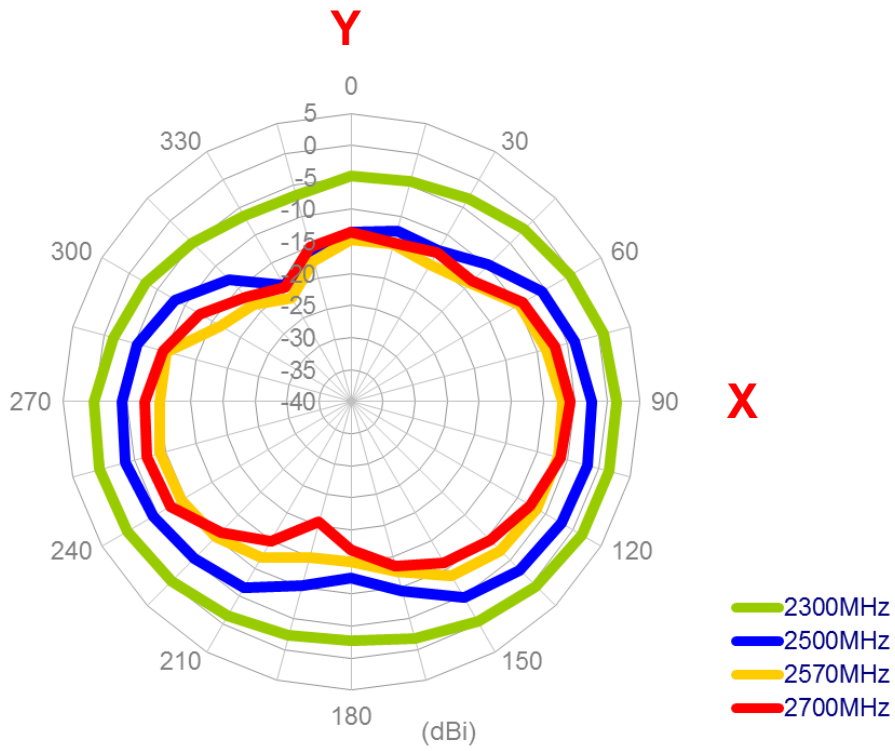

X-Z plane

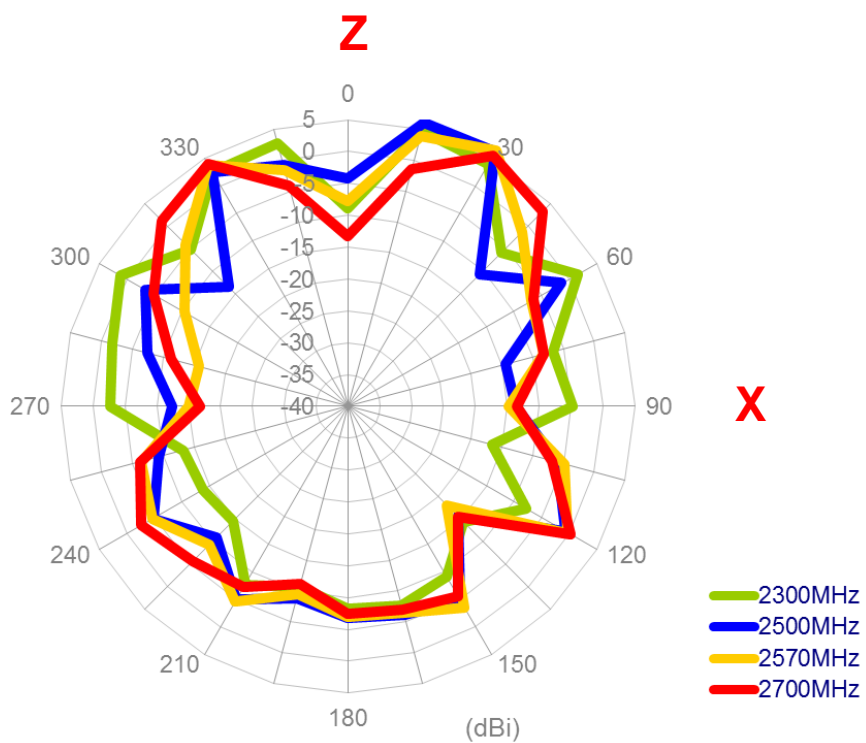

Y-Z plane

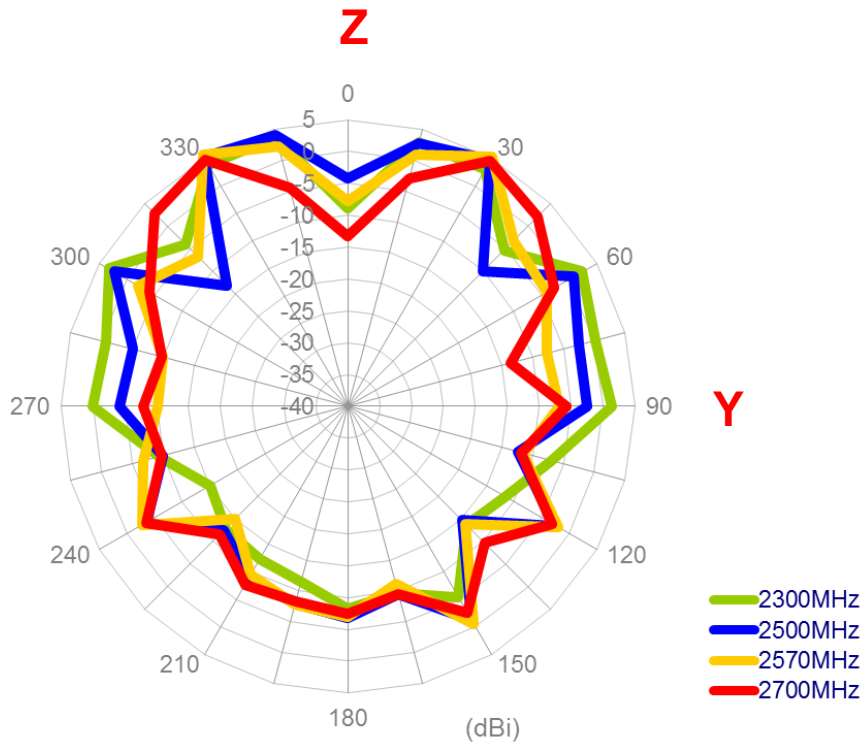

X-Y plane

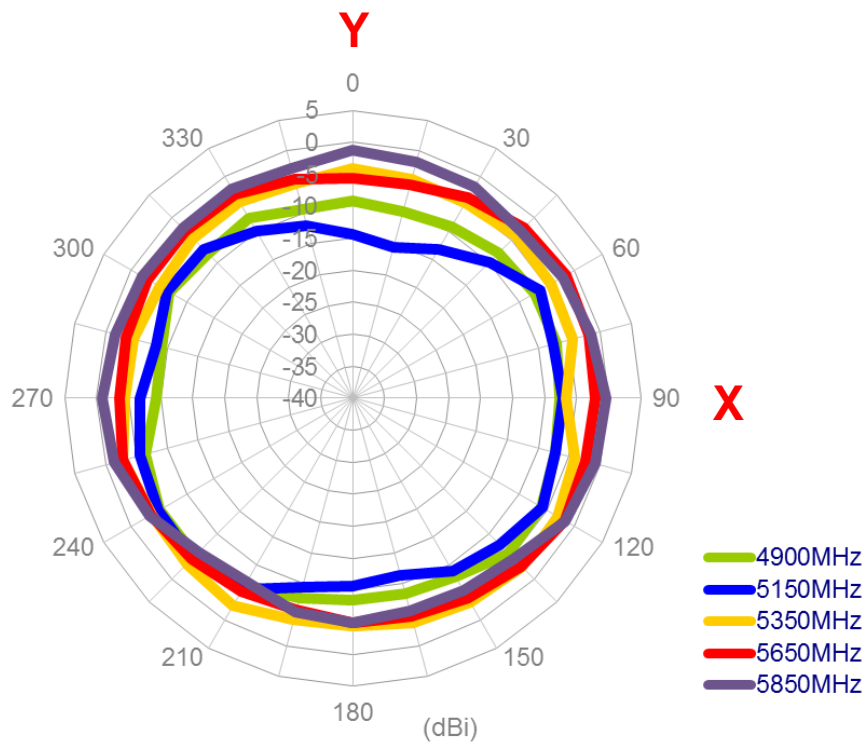

X-Z plane

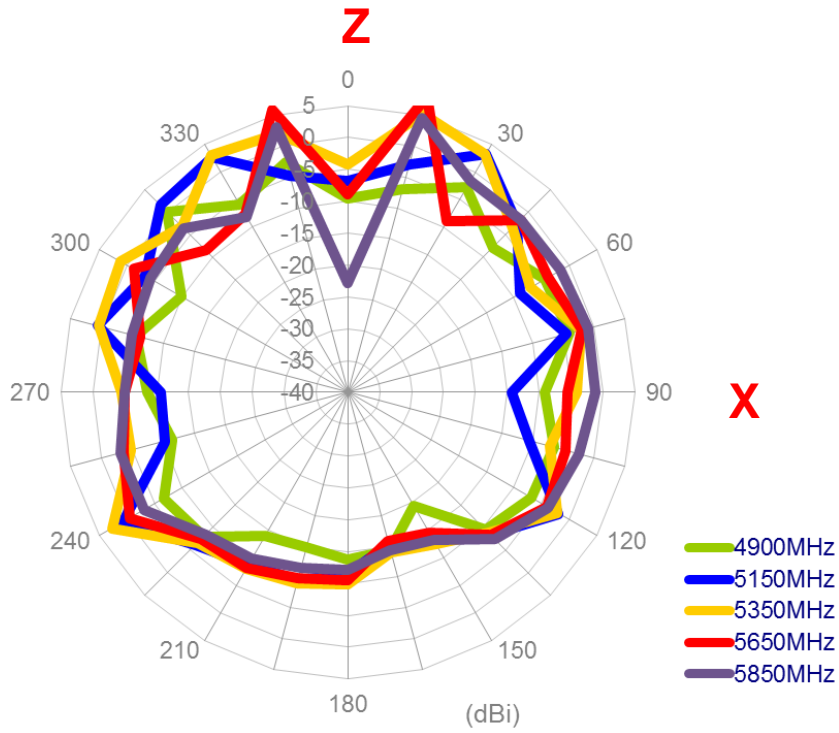

Y-Z plane

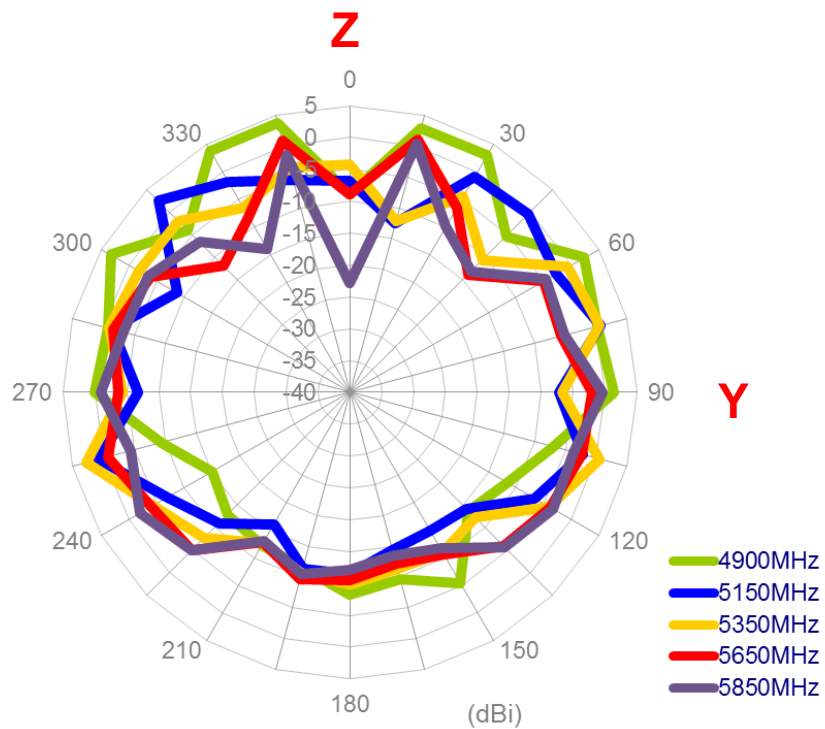

4.11 Antenna setup

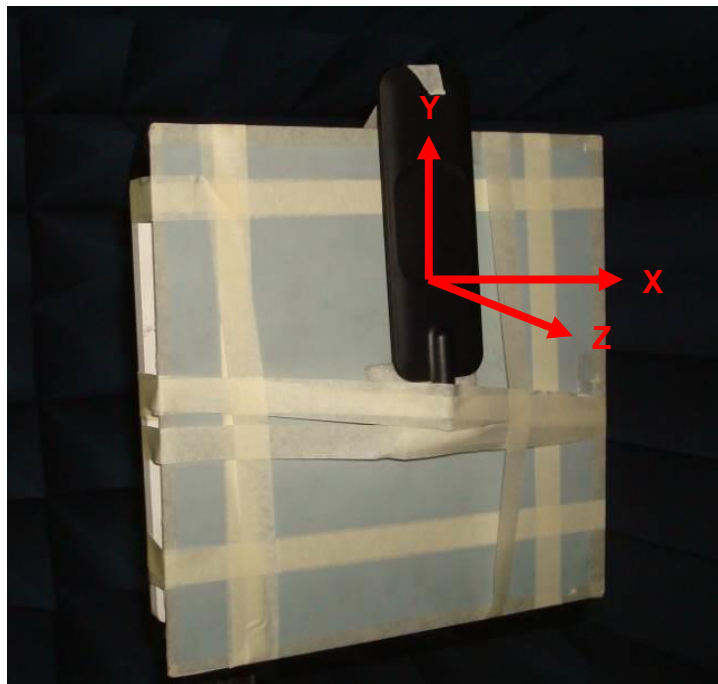

Antenna bent 90 with 30x30cm ground plane center

4.12 Antenna radiation patterns

4.12.1 Antenna bent 90 with 30x30cm ground plane center

X-Y plane

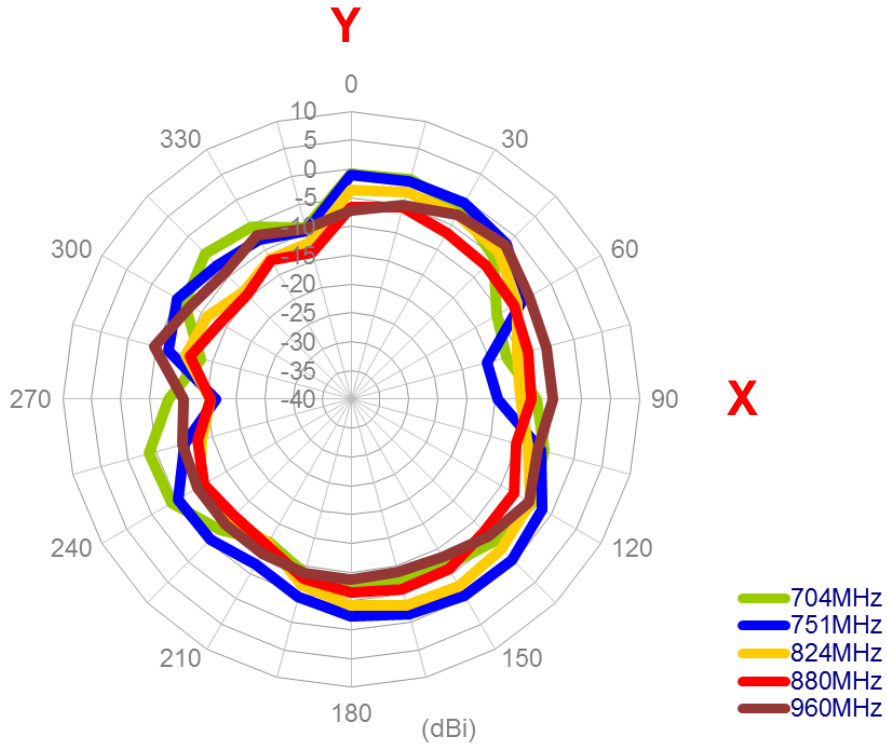

X-Z plane

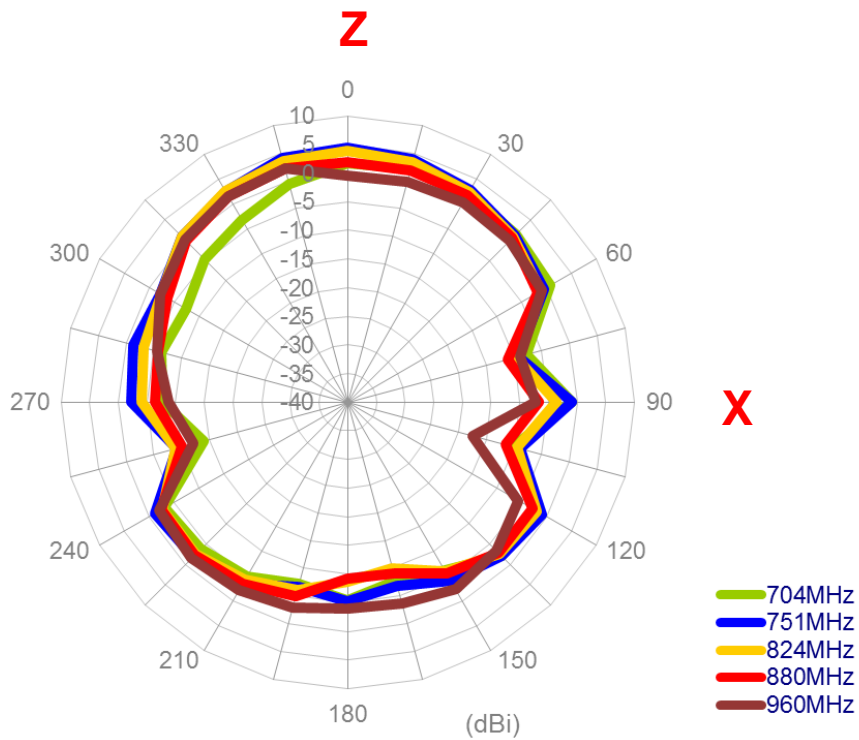

Y-Z plane

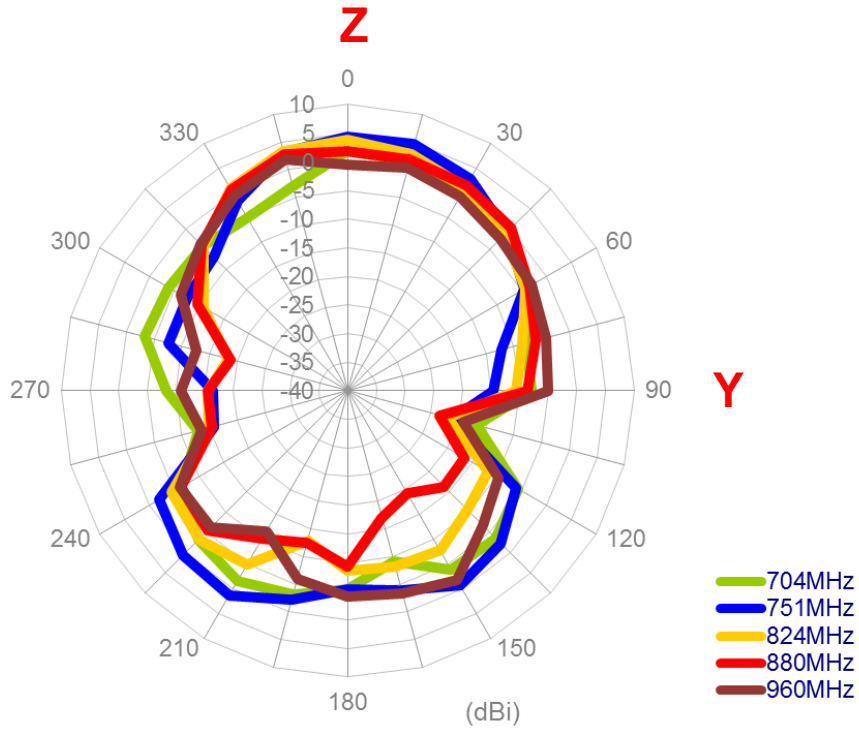

X-Y plane

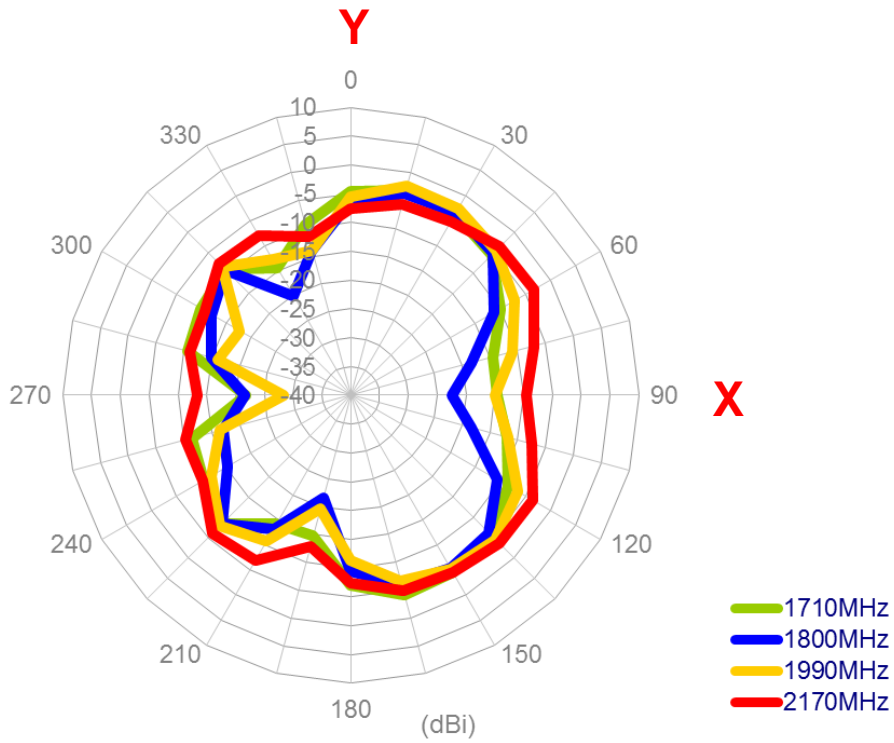

X-Z plane

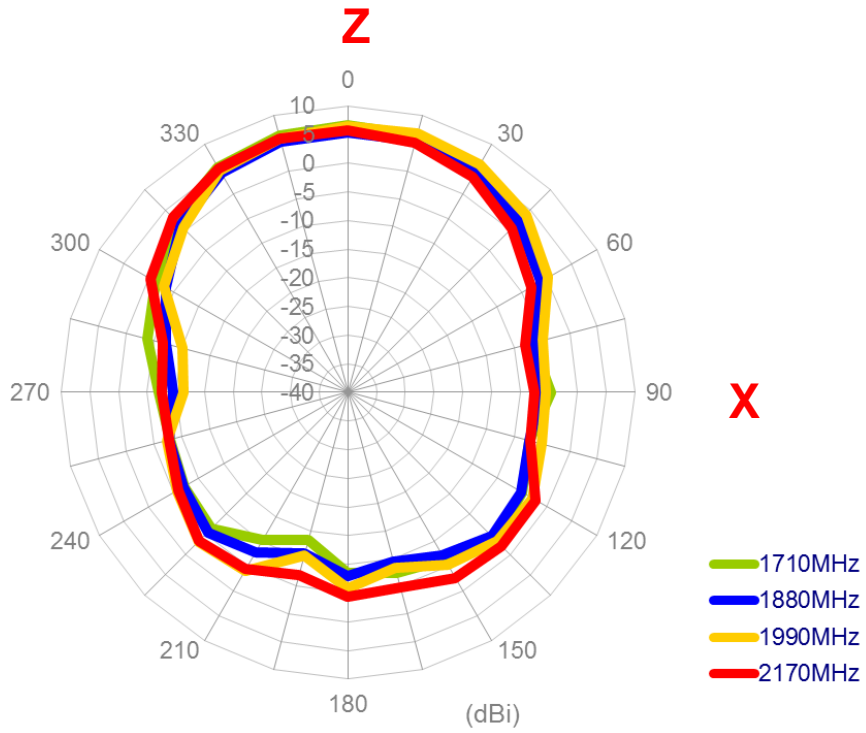

Y-Z plane

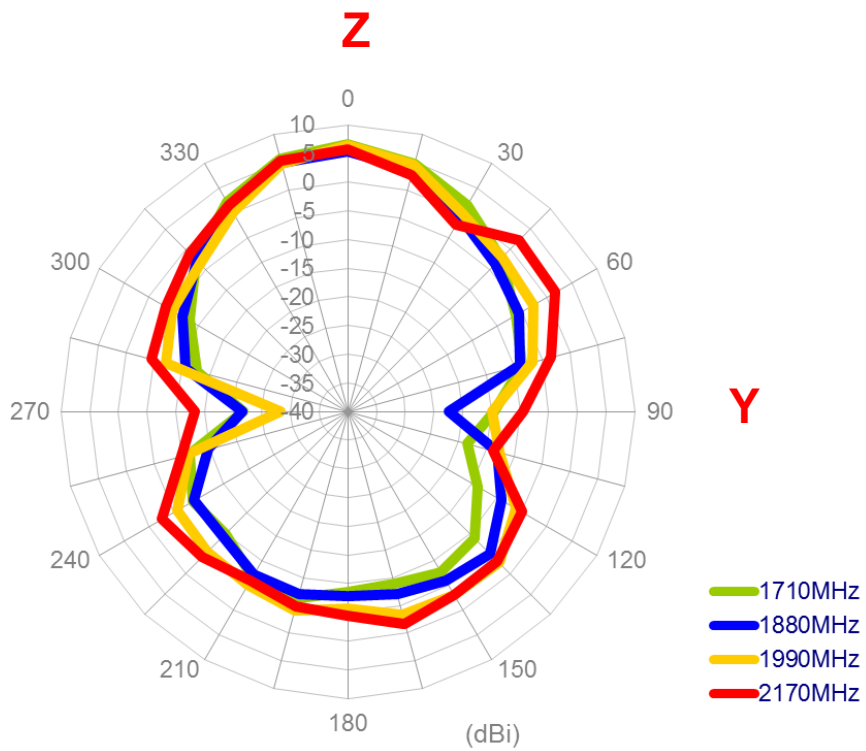

X-Y plane

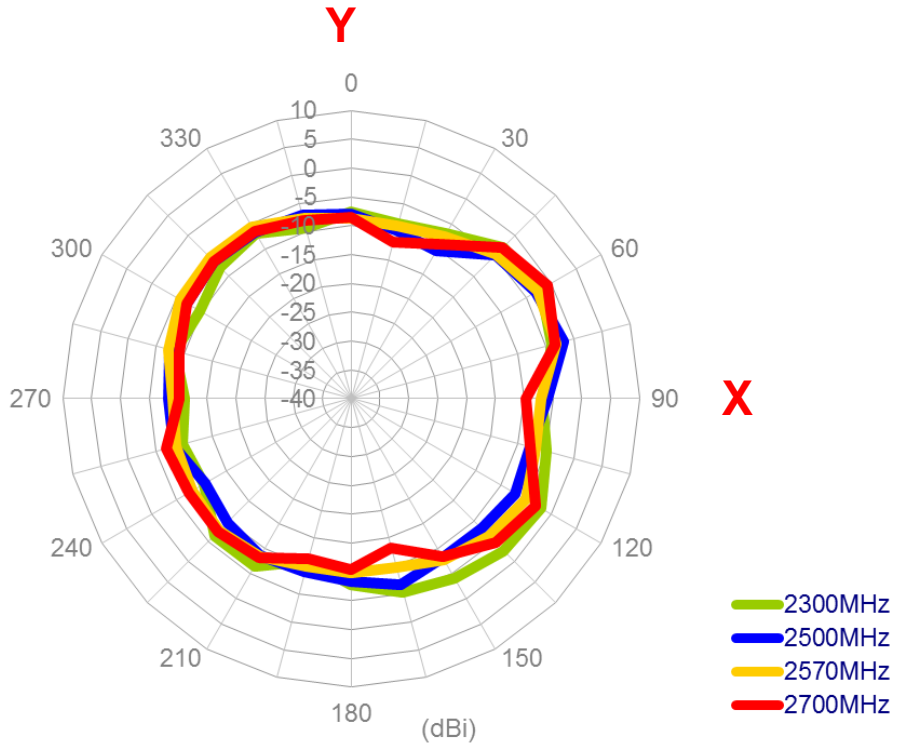

X-Z plane

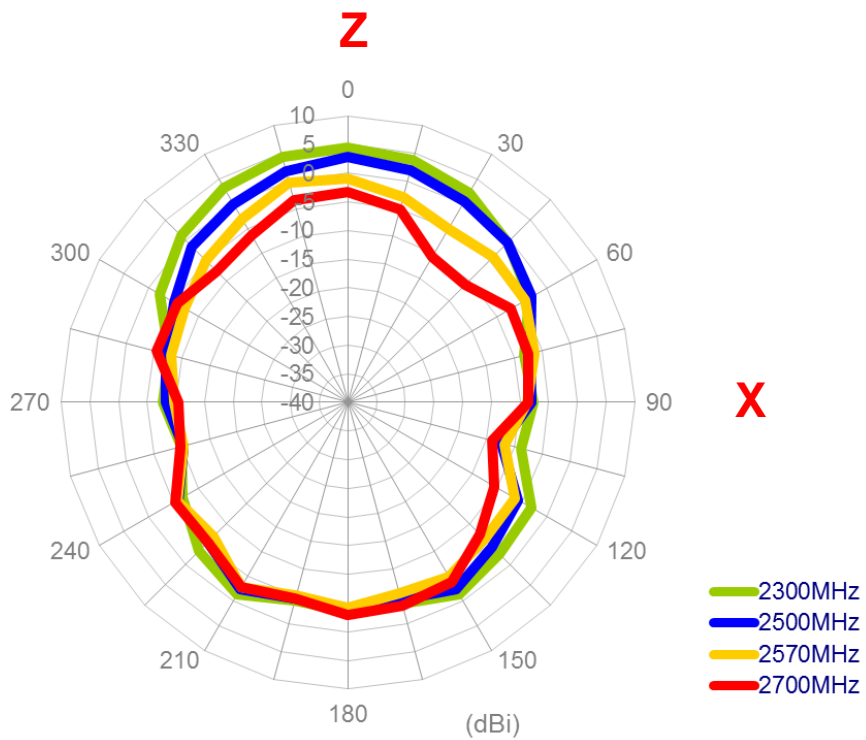

Y-Z plane

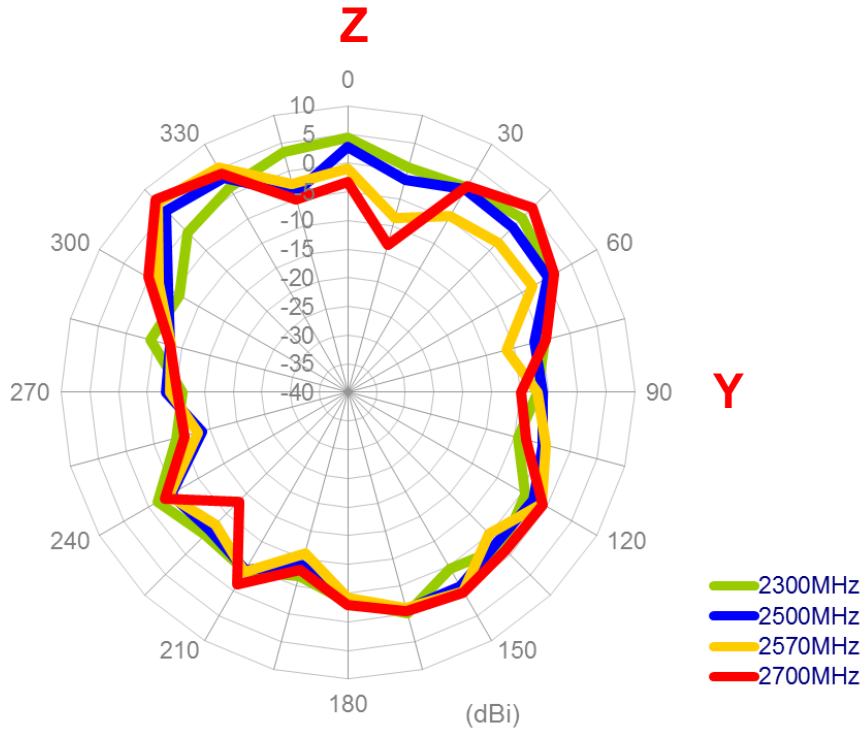

X-Y plane

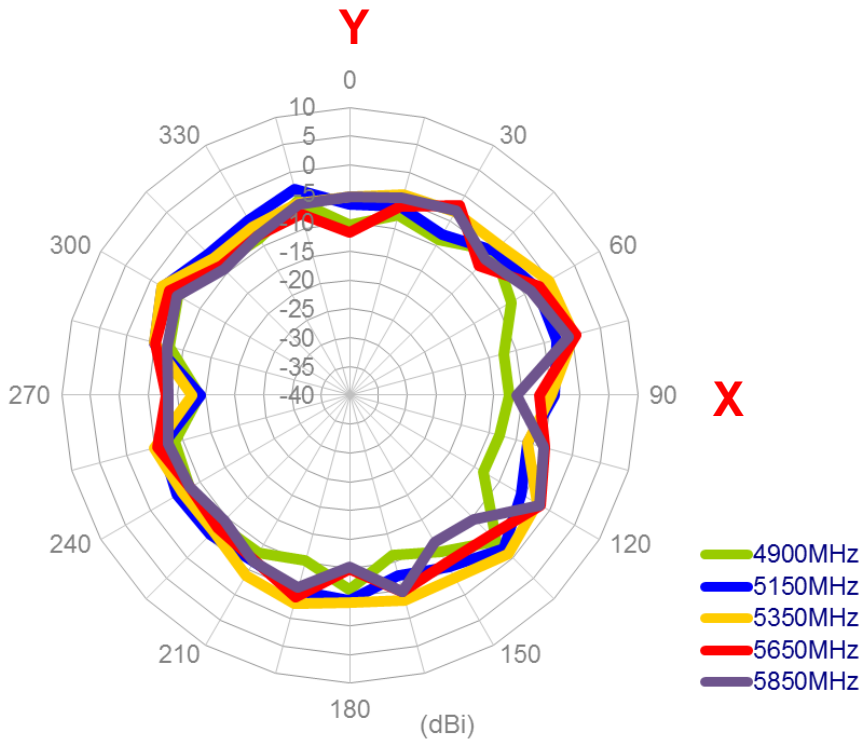

X-Z plane

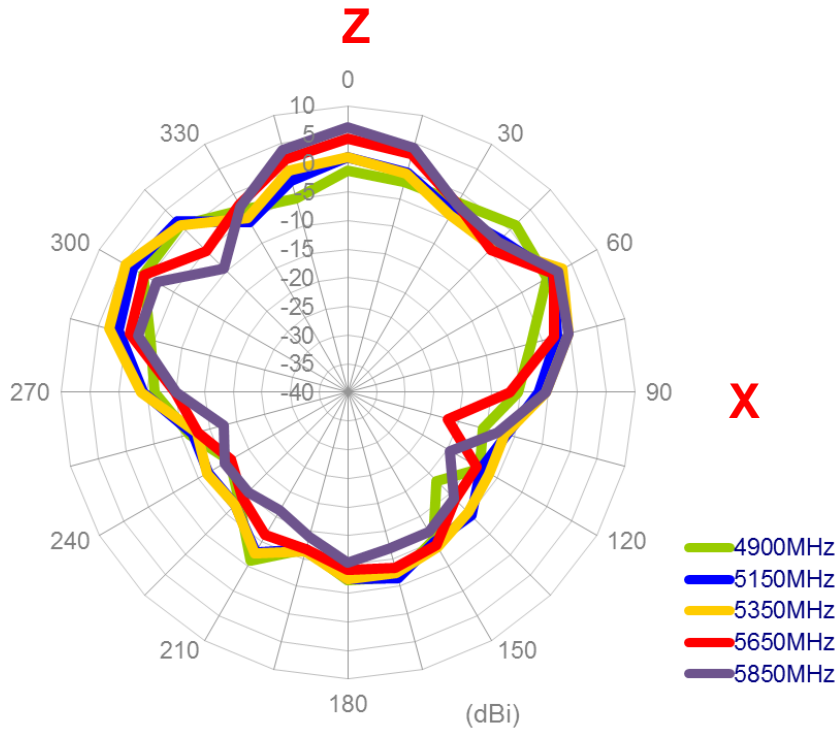

Y-Z plane

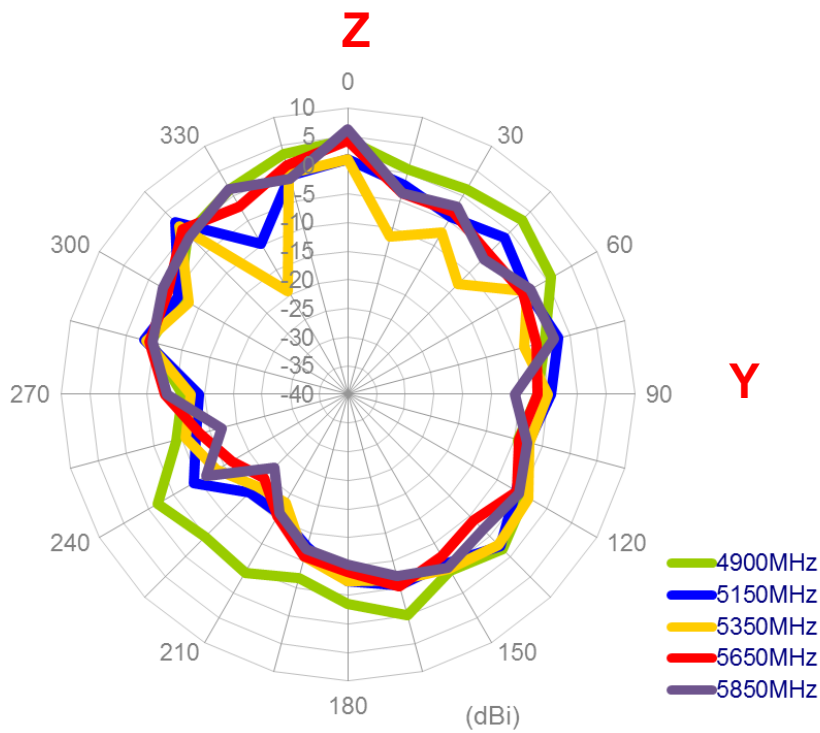

4.13 Antenna setup

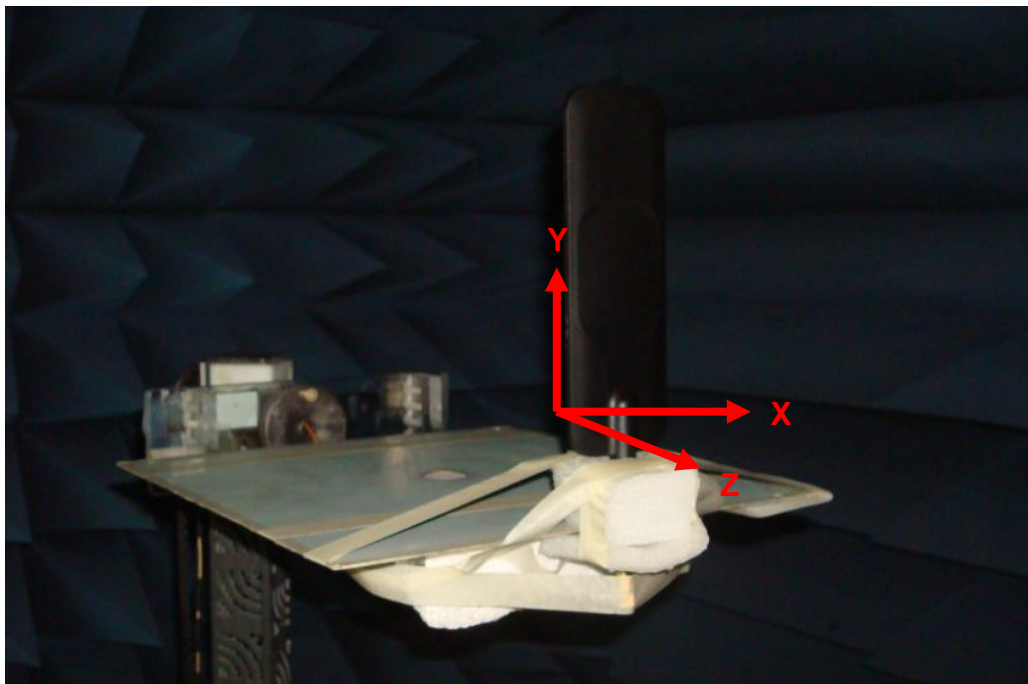

Antenna straight with 30x30cm ground plane edge

4.14 Antenna radiation patterns

4.14.1 Antenna straight with 30x30cm ground plane edge

X-Y plane

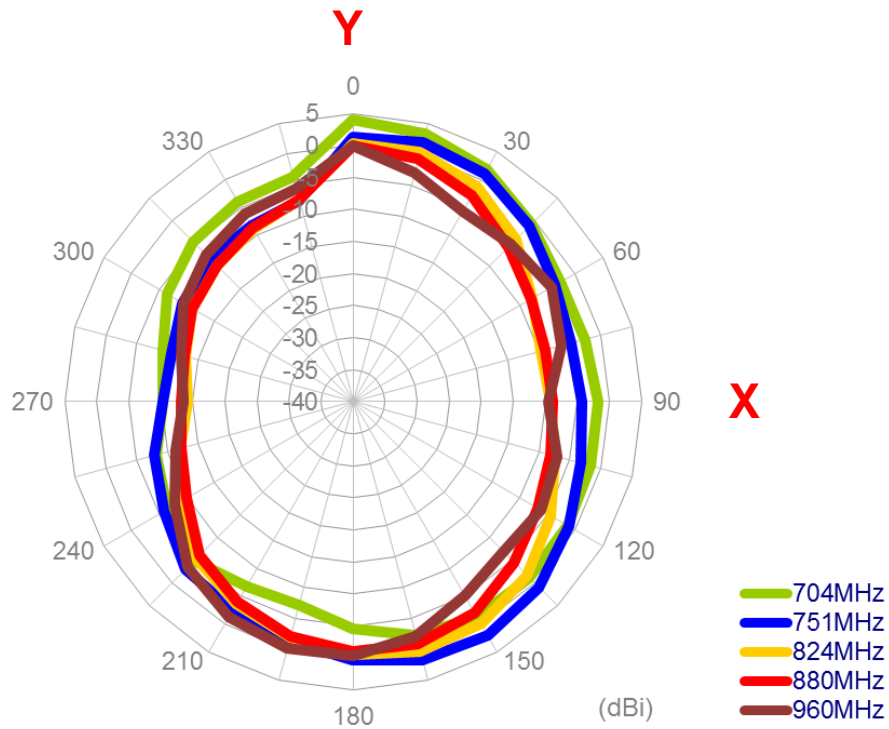

X-Z plane

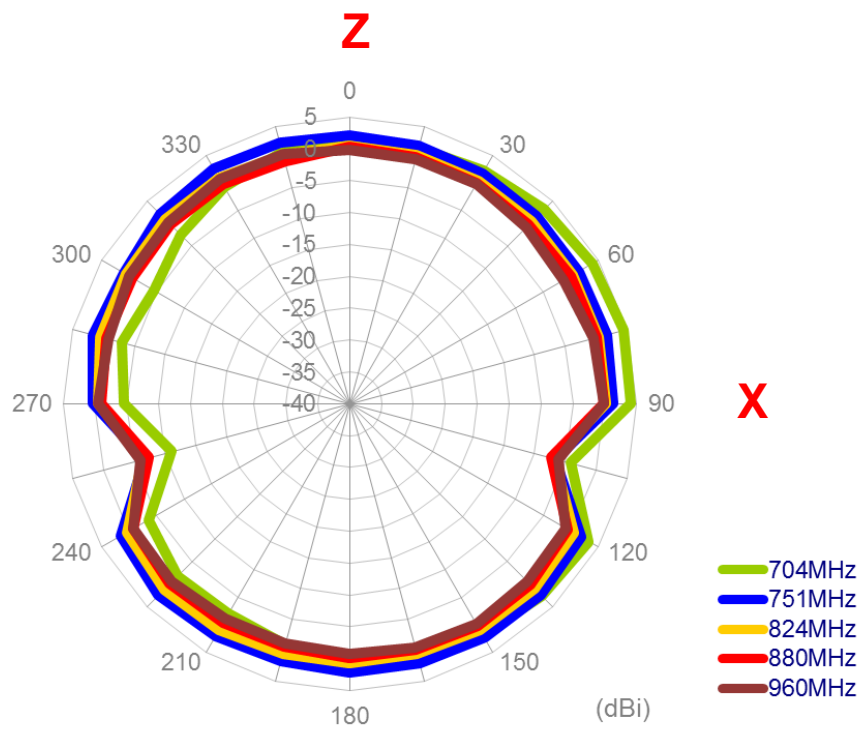

Y-Z plane

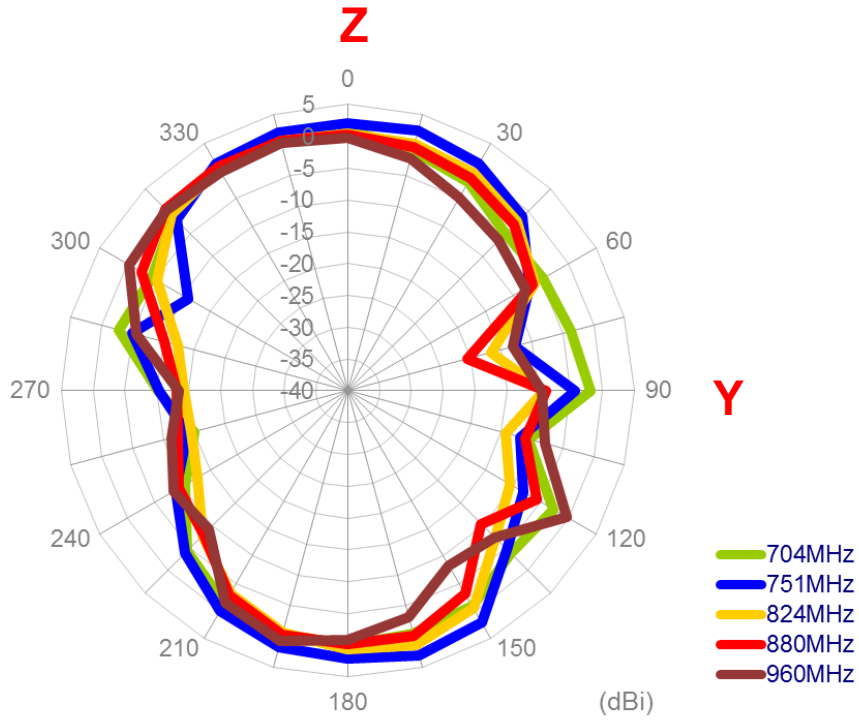

X-Y plane

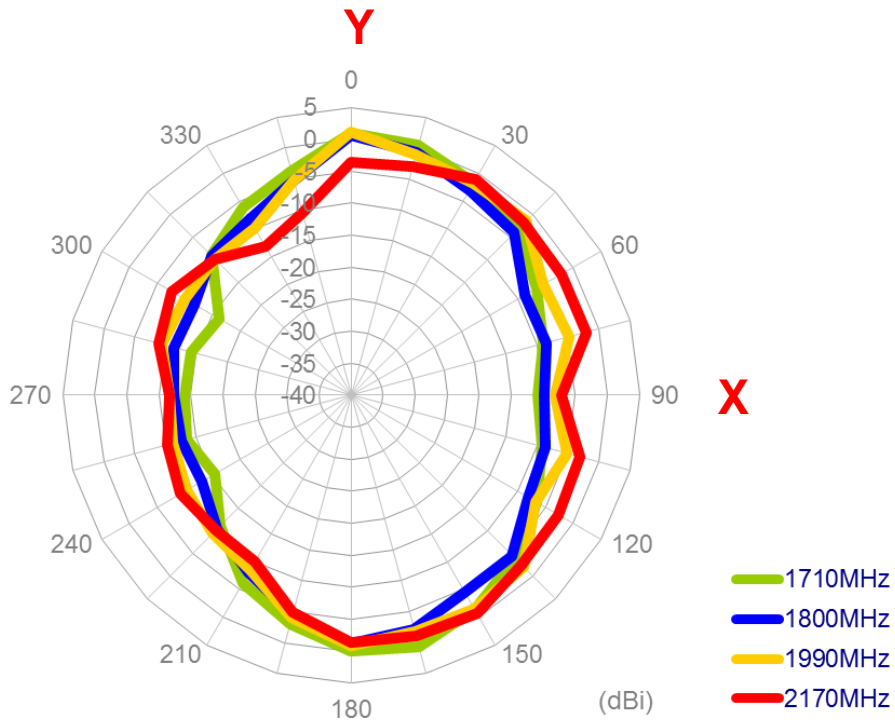

X-Z plane

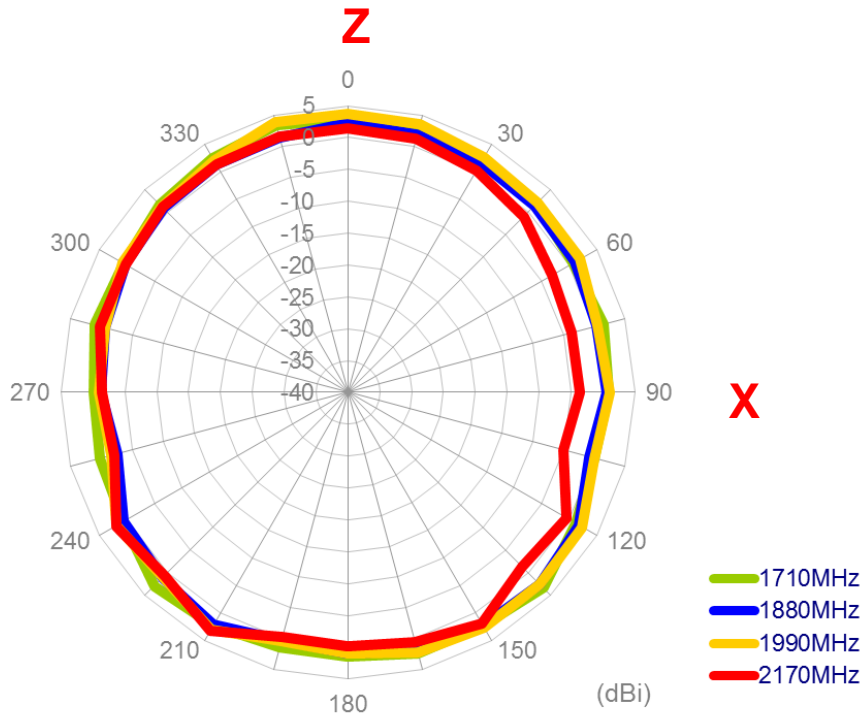

Y-Z plane

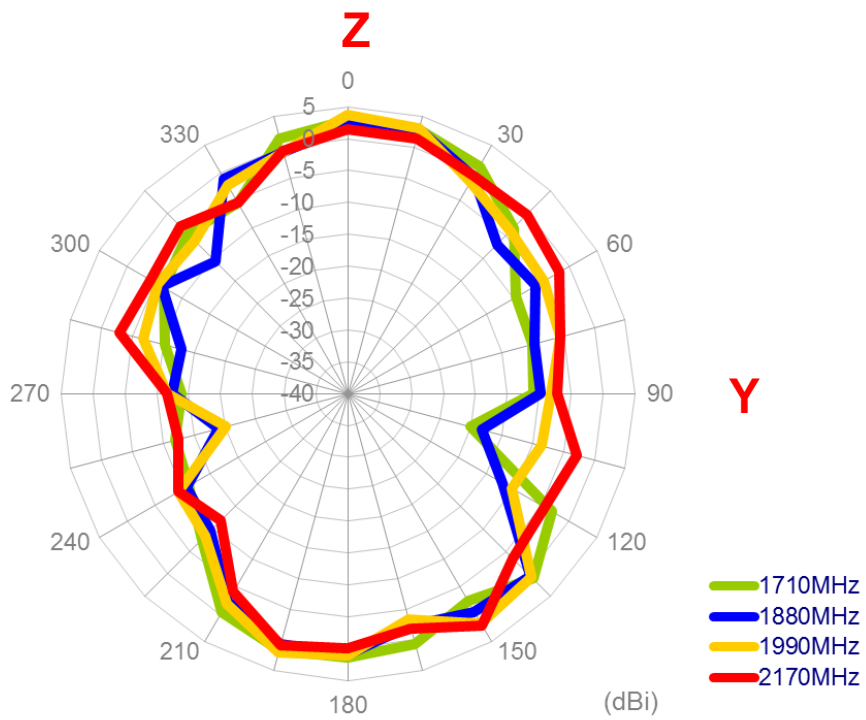

X-Y plane

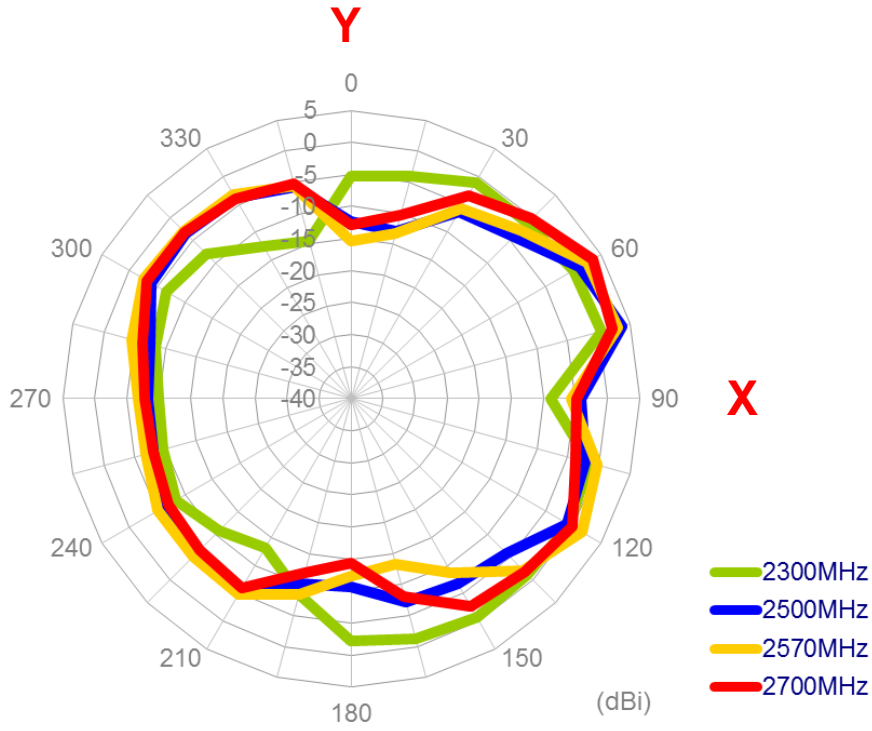

X-Z plane

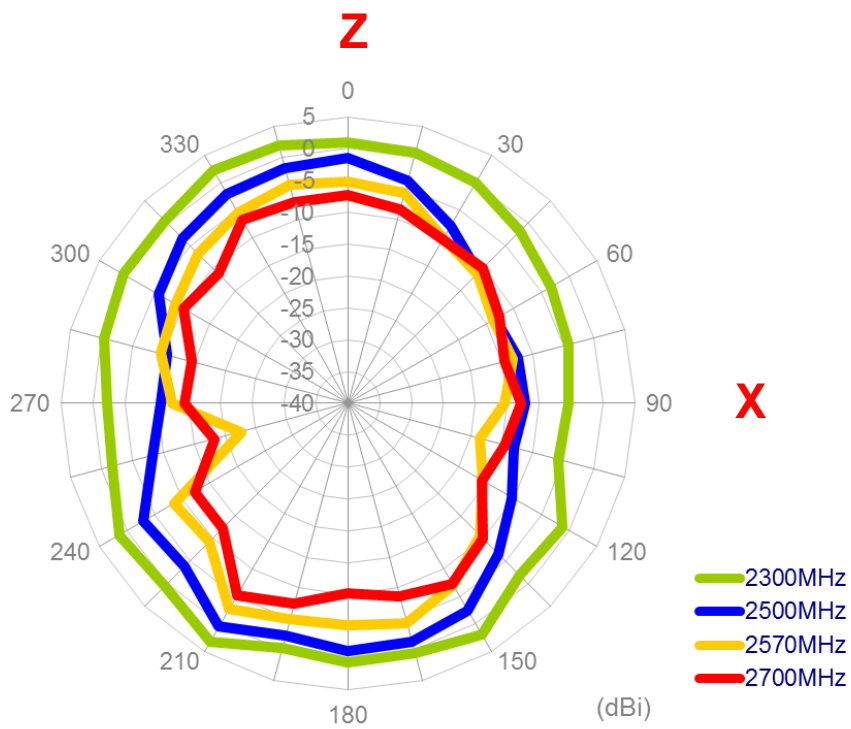

Y-Z plane

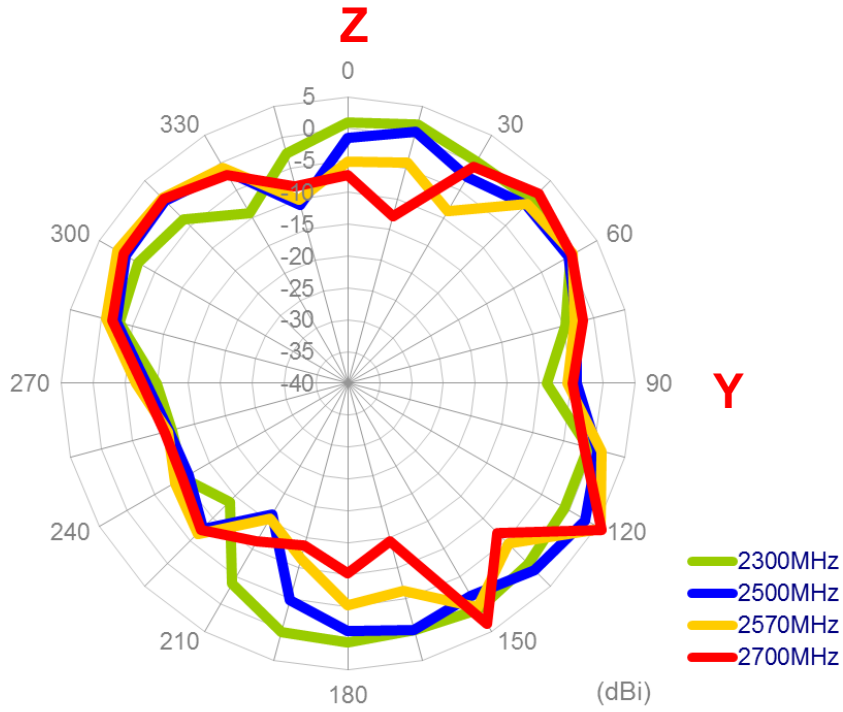

X-Y plane

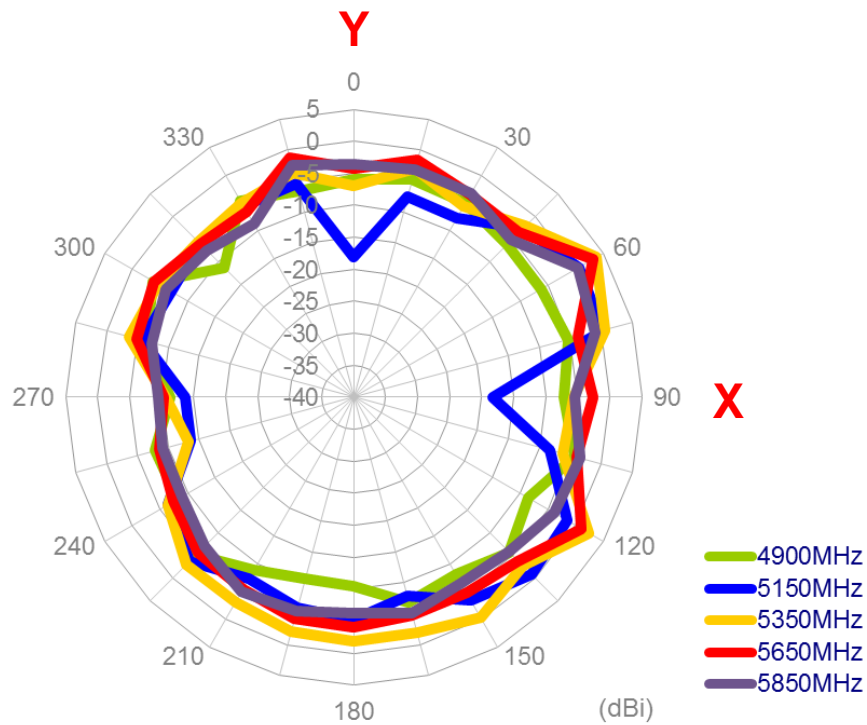

X-Z plane

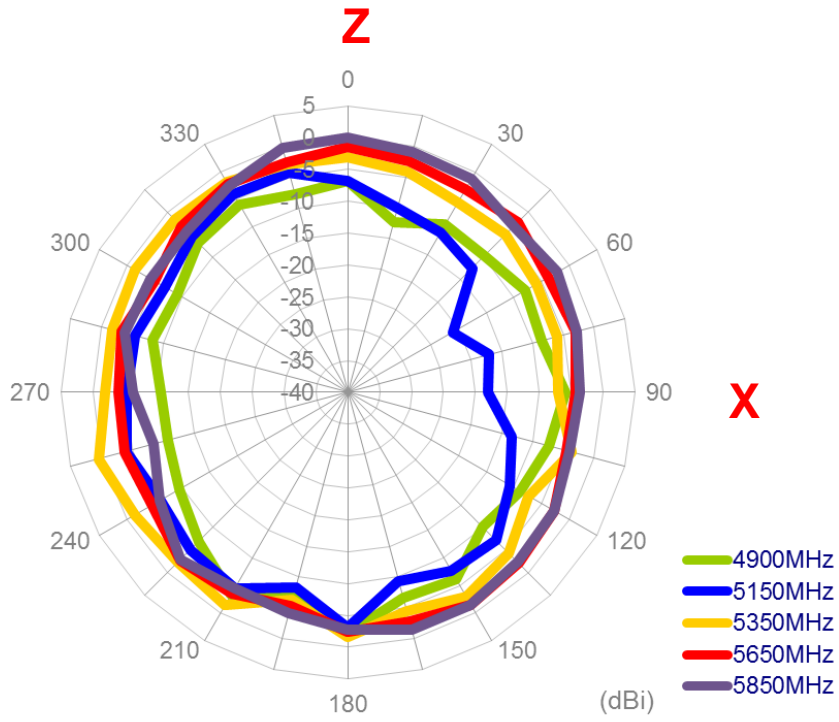

Y-Z plane

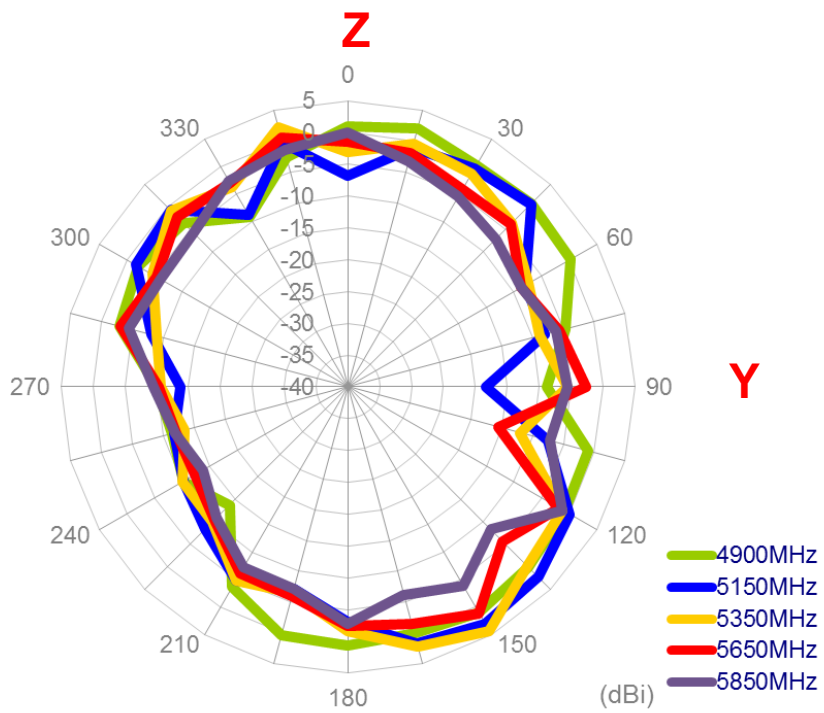

4.15 Antenna setup

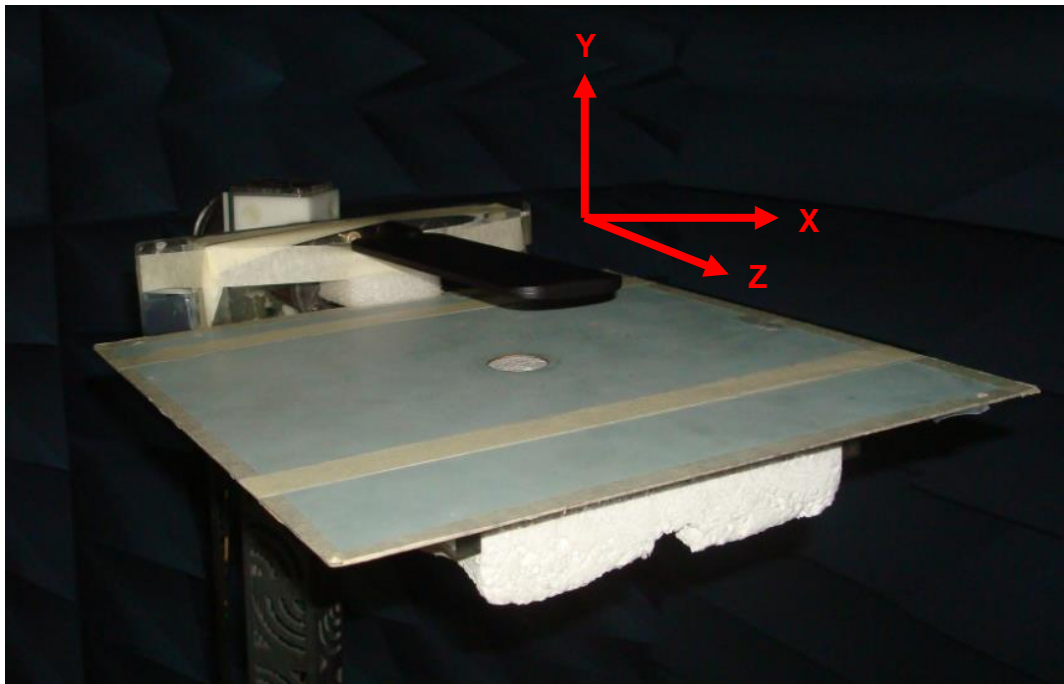

Antenna bent 90 with 30x30cm ground plane edge

4.16 Antenna radiation patterns

4.16.1 Antenna bent 90 with 30x30cm ground plane edge

X-Y plane

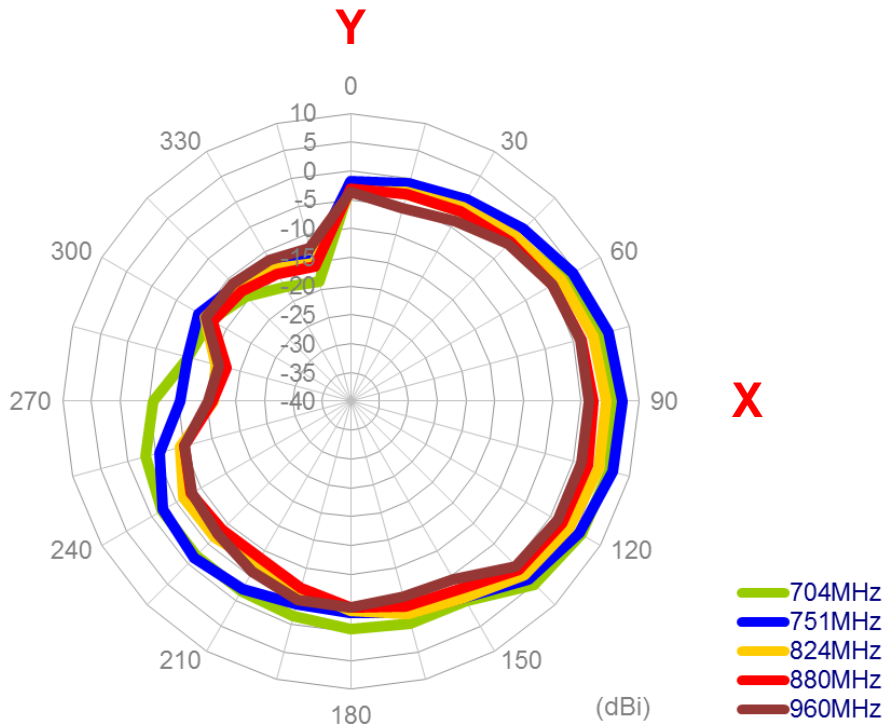

X-Z plane

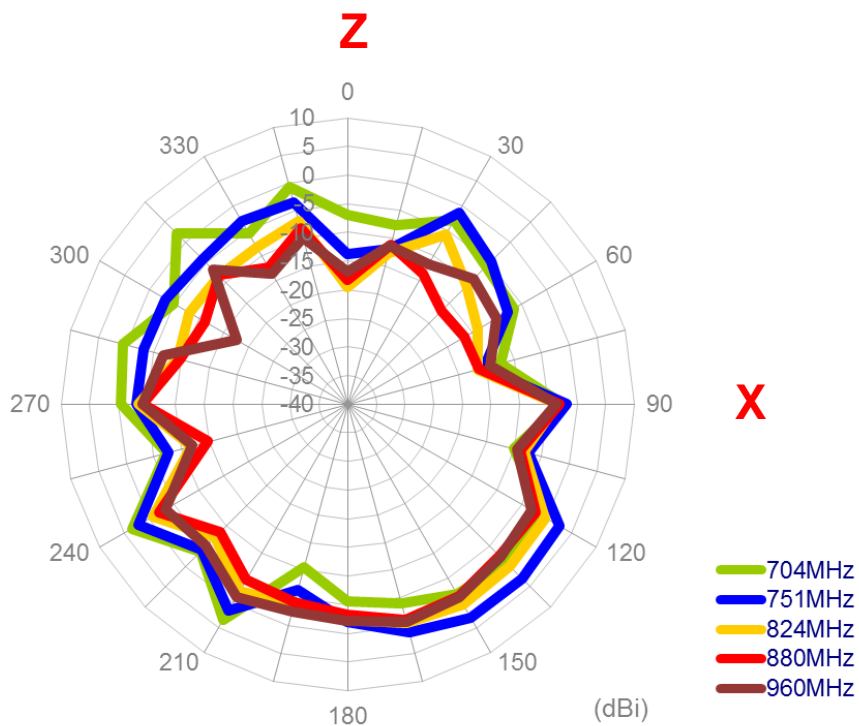

Y-Z plane

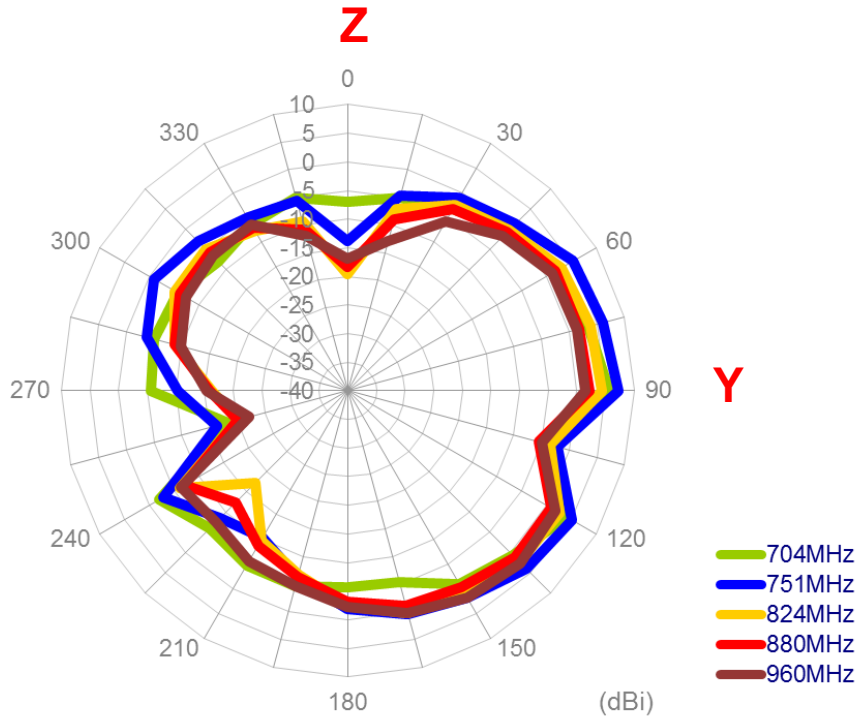

X-Y plane

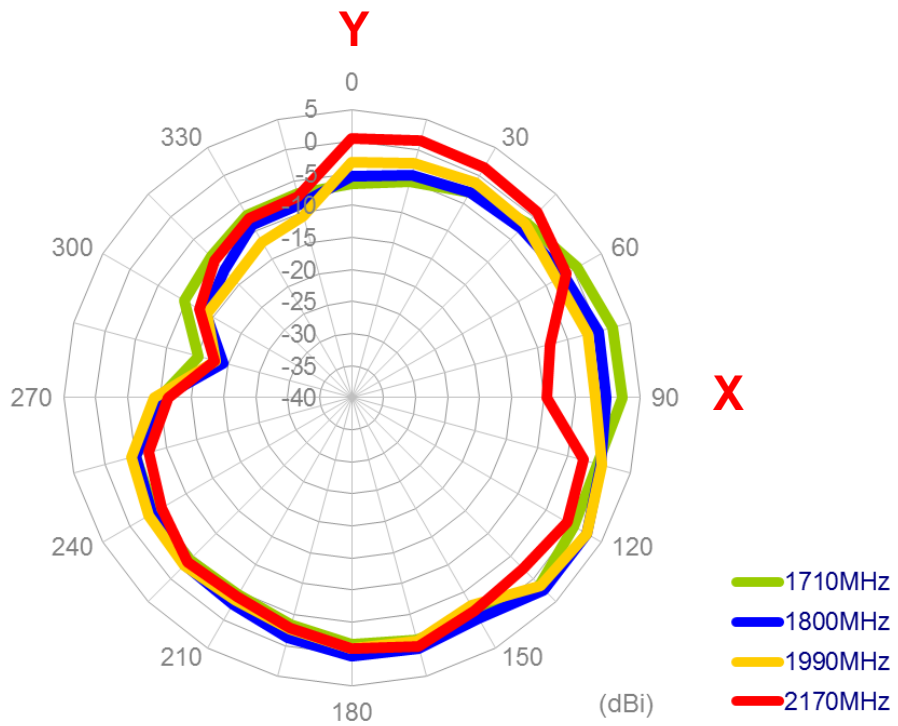

X-Z plane

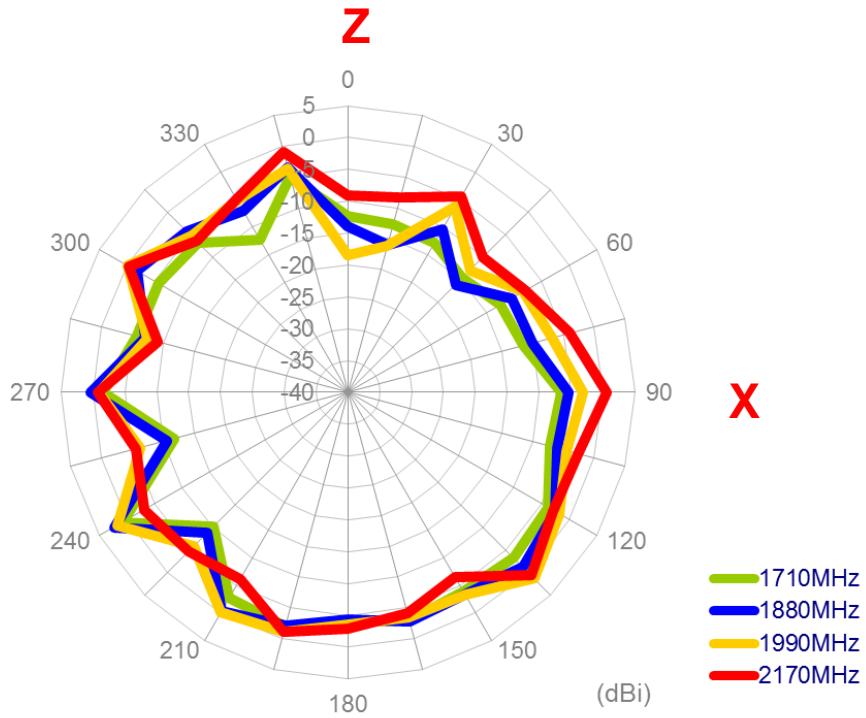

Y-Z plane

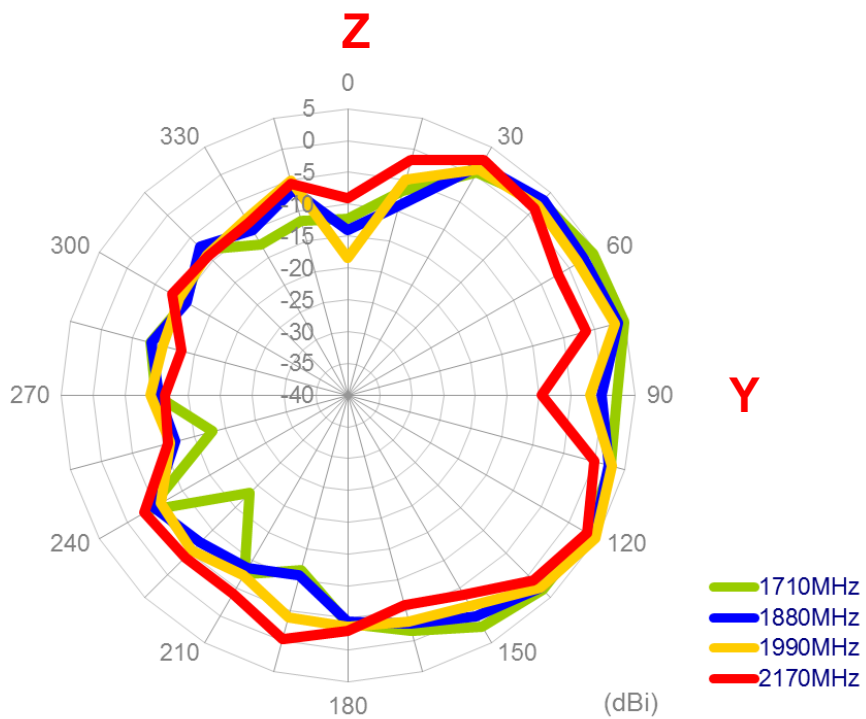

X-Y plane

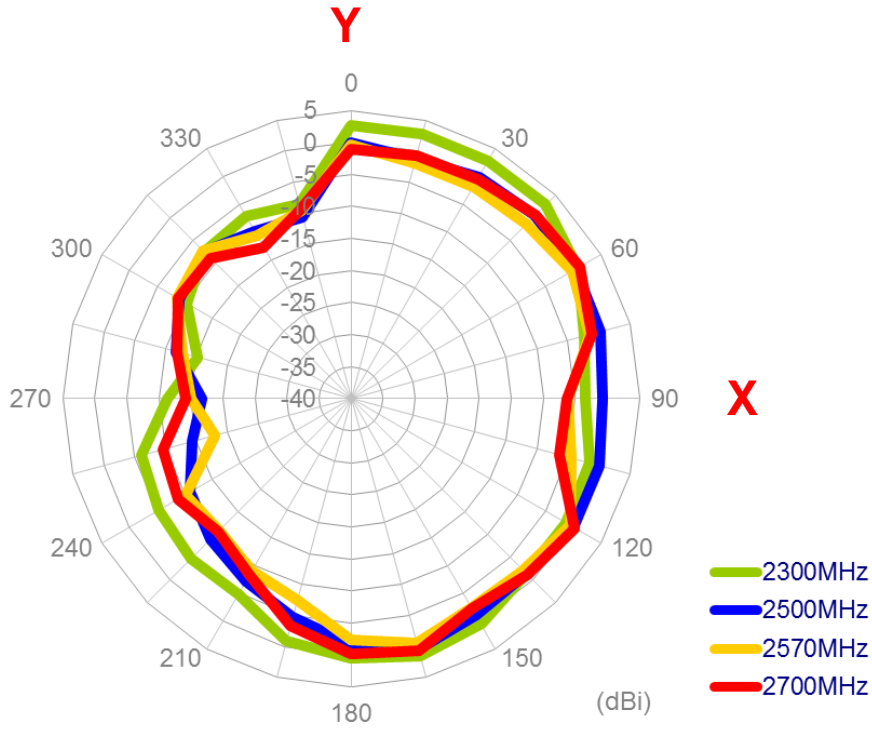

X-Z plane

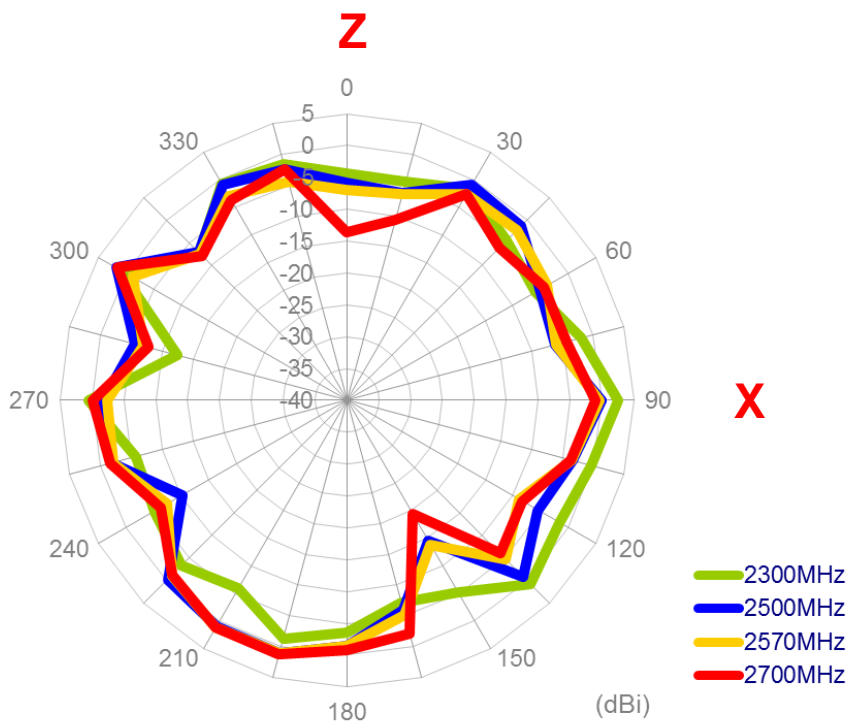

Y-Z plane

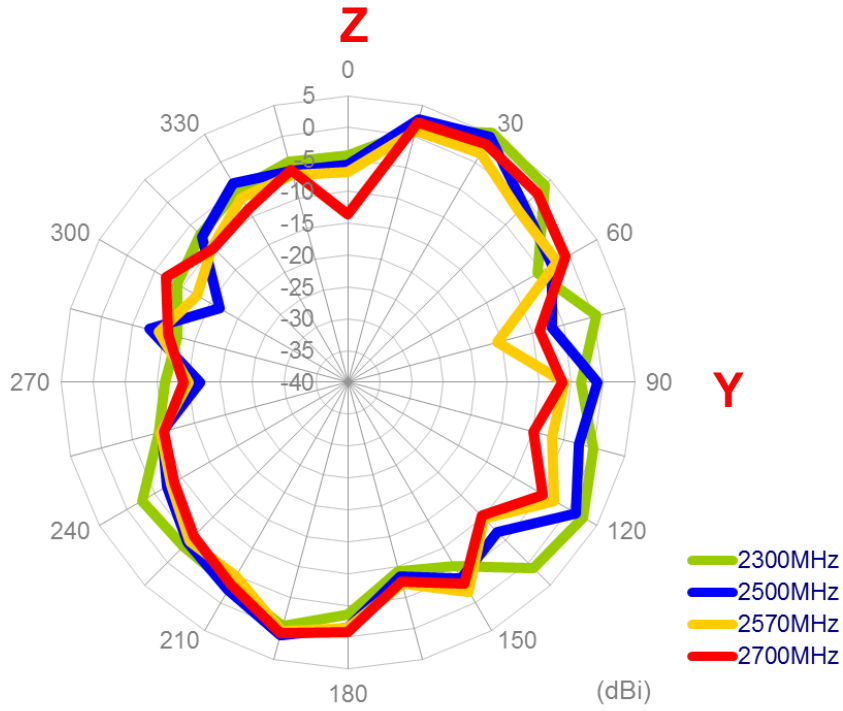

X-Y plane

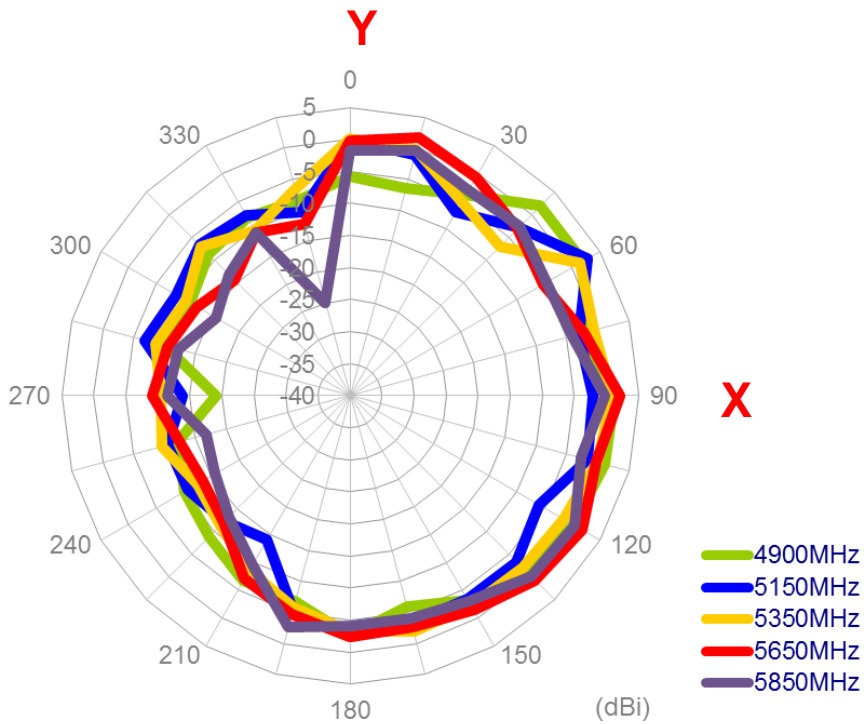

X-Z plane

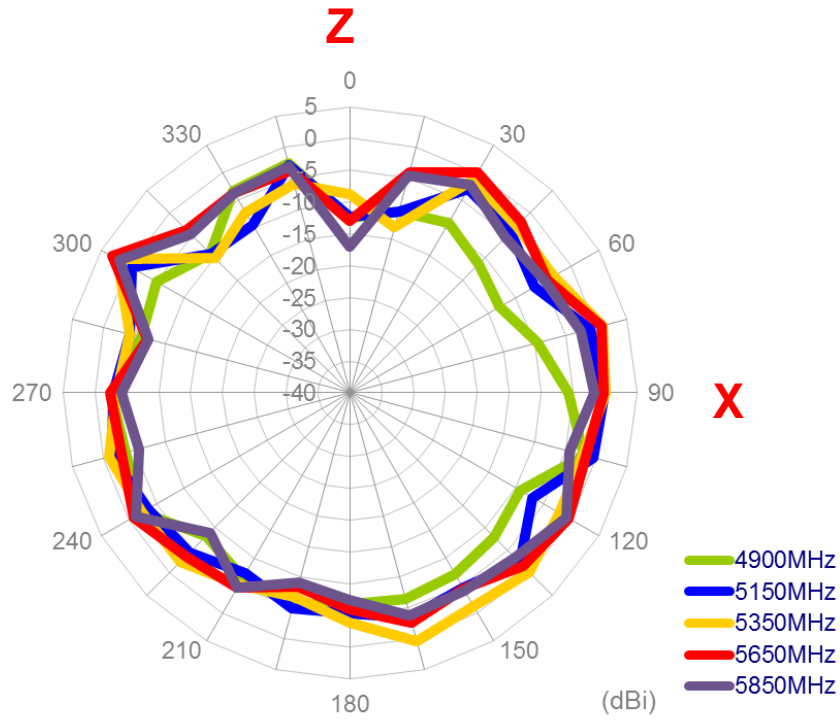

Y-Z plane

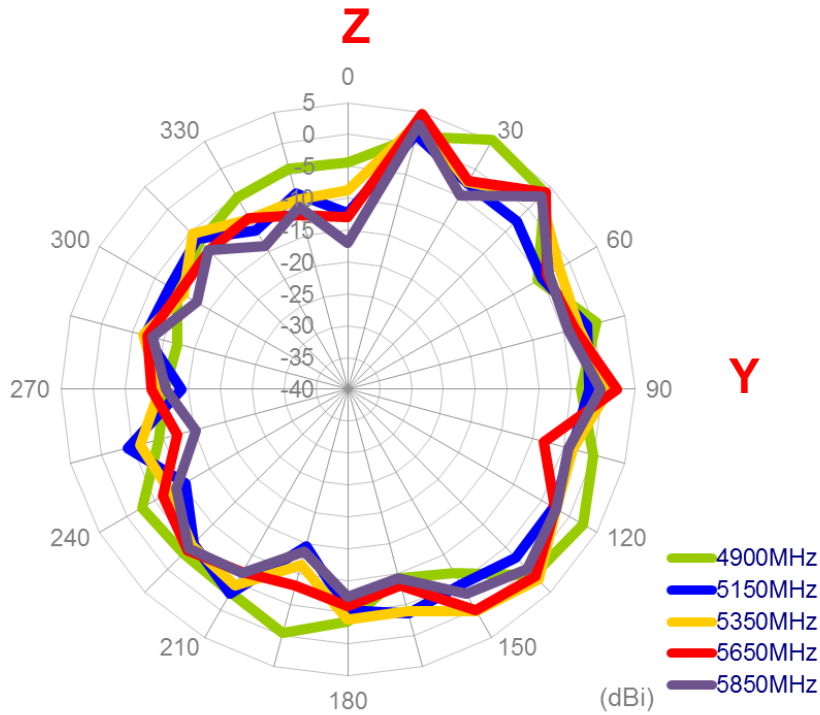

5. Installation

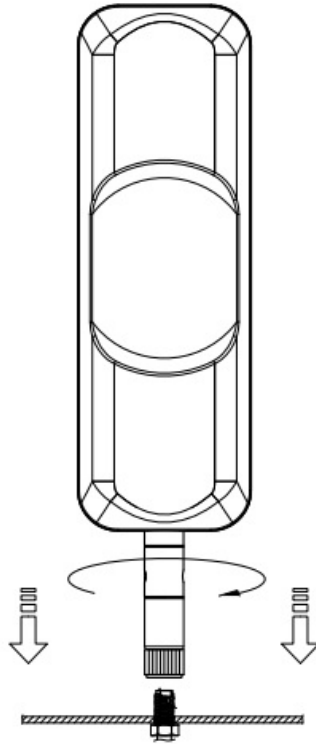

Recommended torque for mounting is 0.9 N·m
Maximum torque for mounting is 1.176 N·m

TG.35 Installation Instructions

The TG.35 antenna has an independent rotatable SMA connector, which enables users to install the antenna in a preferable direction. After tightening the SMA connector, the antenna will sit firmly on users' base/router either on a table or on a wall. This installation sheet illustrates using the TG.35 on a wall mounted device as an example.

Step 1.

Adjust the antenna to preferable direction, then mount the SMA(M) connector on devices SMA(F) connector. (See figure 1)

Step 2.

Hold the antenna housing with one hand, while rotating the SMA(M) connector with the other hand until the connector is tight. If the connector was tightened properly, the antenna will keep its position without slipping down. (See figure 2)

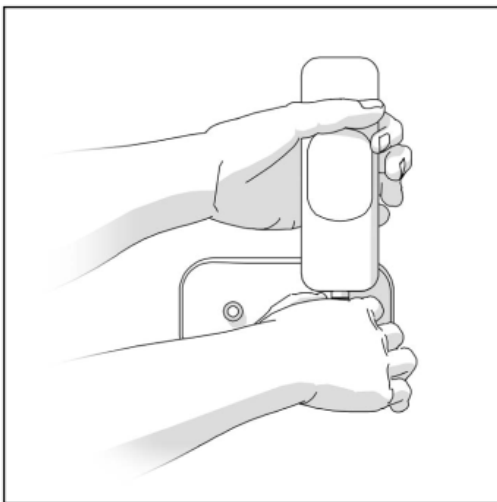

Figure 1.

Place the TG.35 antenna onto the connector of the device and hold the antenna in the preferred orientation.

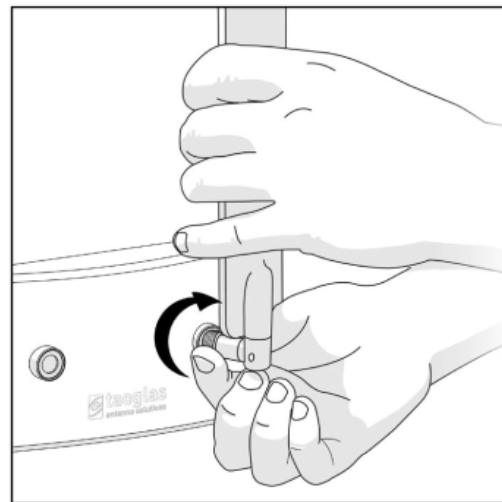
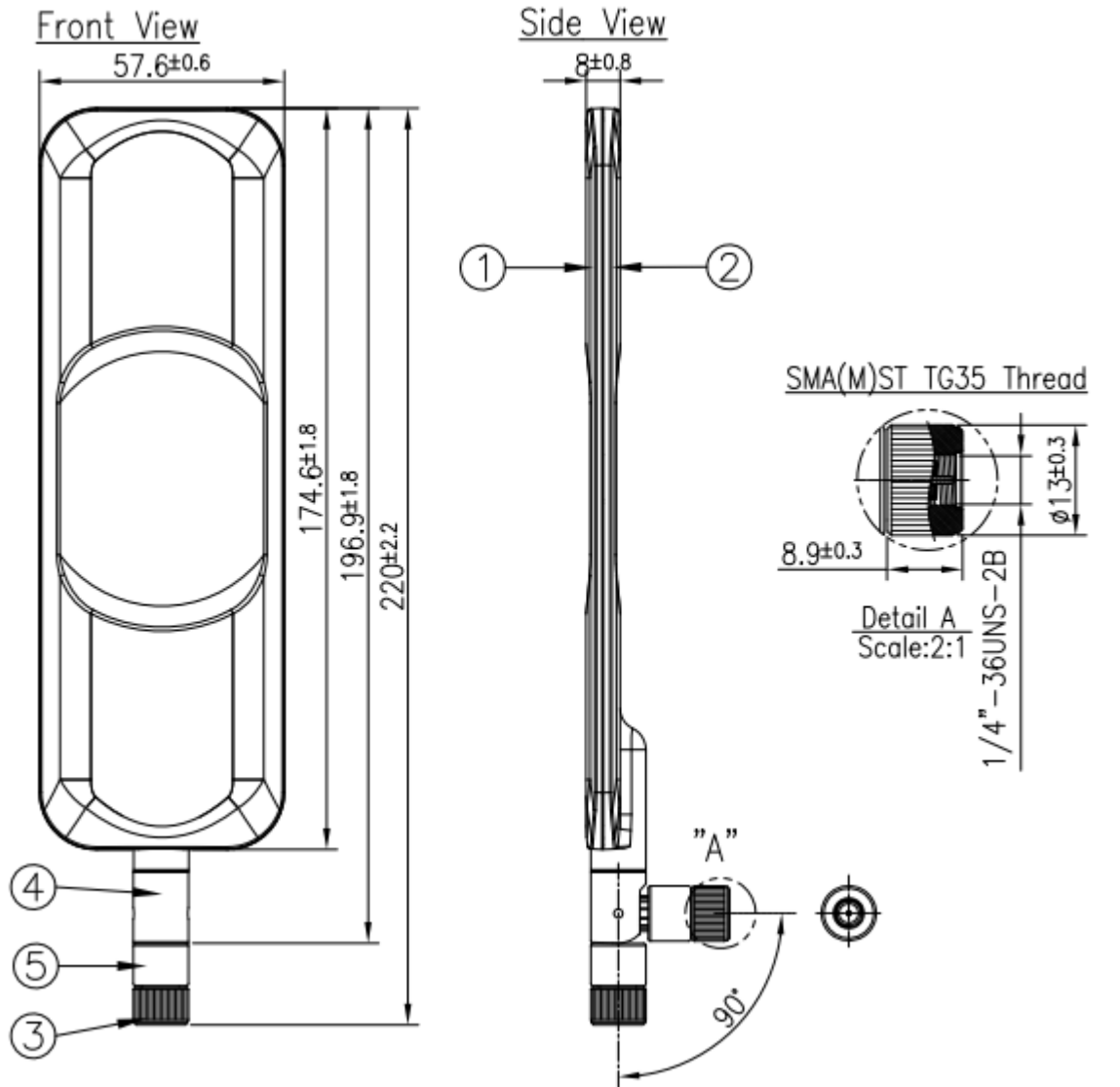

Figure 2.

Fix the connector to the device by twisting the rotating head of the SMA connector until it is tight enough to hold the antenna in the correct position.

6. Drawing



3D View

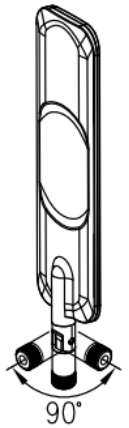

	Name	Material	Finish	QTY
1	Housing Top TG35	ABS	Black	1
2	Housing Bottom TG35	ABS	Black	1
3	SMA(M)ST TG35 Thread	Brass	Black	1
4	Hinge Top TG35 Type2	POM UV270Z	Black	1
5	Hinge Bottom TG35 Type2	No.5 Zinc Alloy	Black	1

7. Packaging

TG.35.8113

Packaging Specifications

1 pc TG.35.8113 per PE bag
 PE Bag Dimensions - 100 x 280mm
 Weight - 73.5g

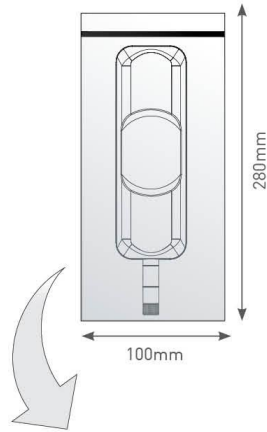

25 PE bags per large PE bags
 25 pcs TG.35.8113 per large PE bags
 Carton Dimensions - 280 x 430mm
 Weight - 1.85kg

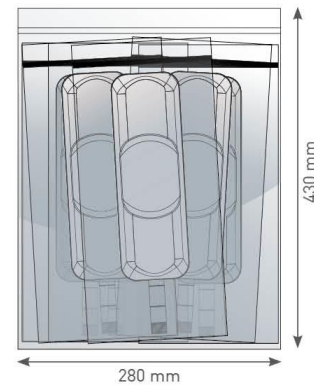

3 Large PE bags per carton
 75 pcs TG.35.8113 per carton
 Carton Dimensions - 330 x 260 x 300mm
 Weight - 6.1kg

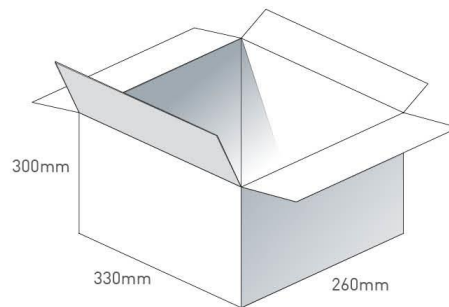

Pallet Dimensions 1200*1000*1350mm
 48 Cartons per Pallet
 8 Cartons per layer
 6 Layers

