

THIS DRAWING IS UNPUBLISHED. RELEASED FOR PUBLICATION
 © COPYRIGHT - By - ALL RIGHTS RESERVED.

LOC		DIST		REVISIONS			
P	LTR	DESCRIPTION	DATE	DWN	APVD		
D2		REDRAWN & REV PER ECO-12-018940	16JAN2013	BC	RP		

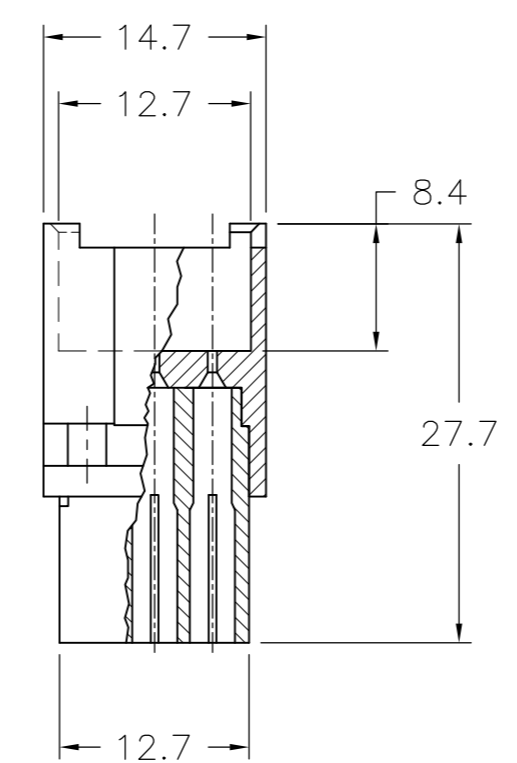

- 1 MATERIAL: 20% GLASS FILLED NORYL, COLOR: GREY RAL 7032.
- 2 BLOCK MARKING AND CAVITY NUMBERS PRINTED IN GREEN COLOR.

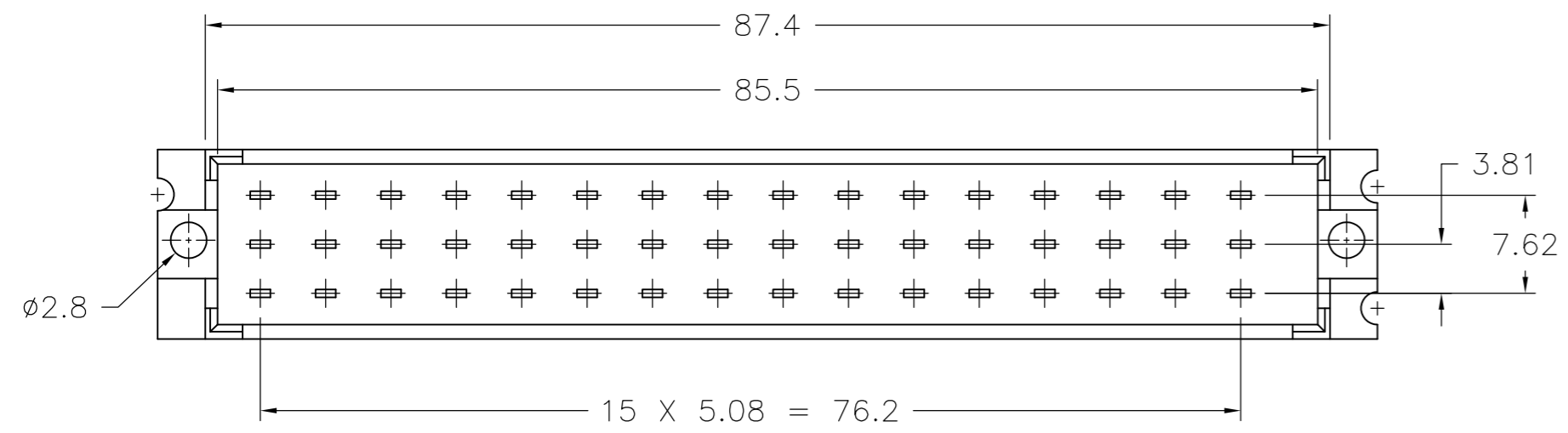
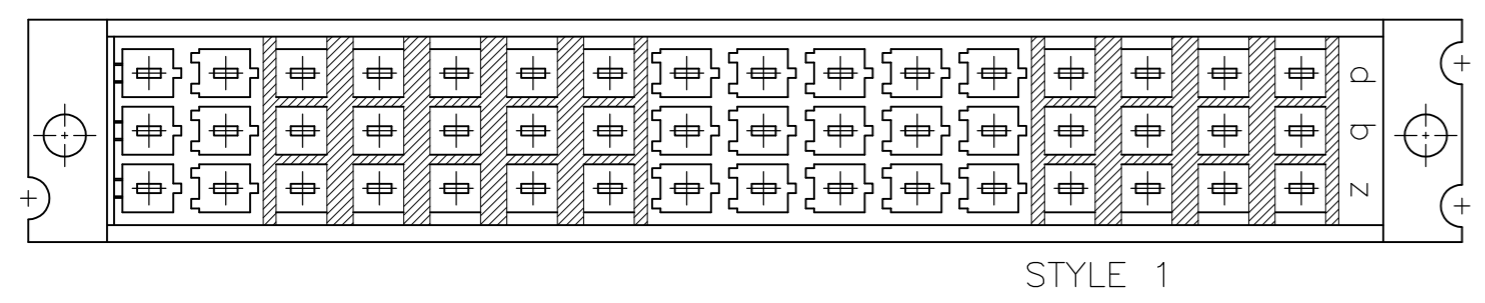
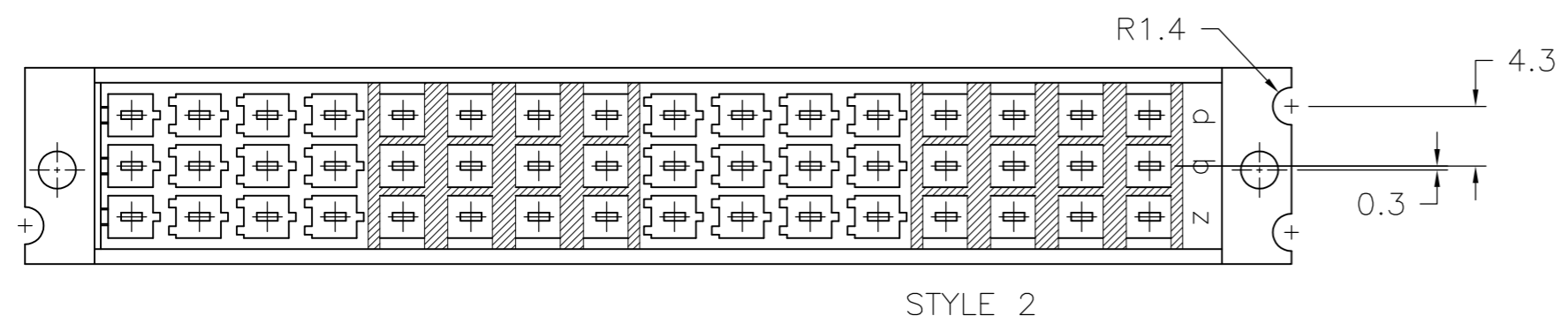
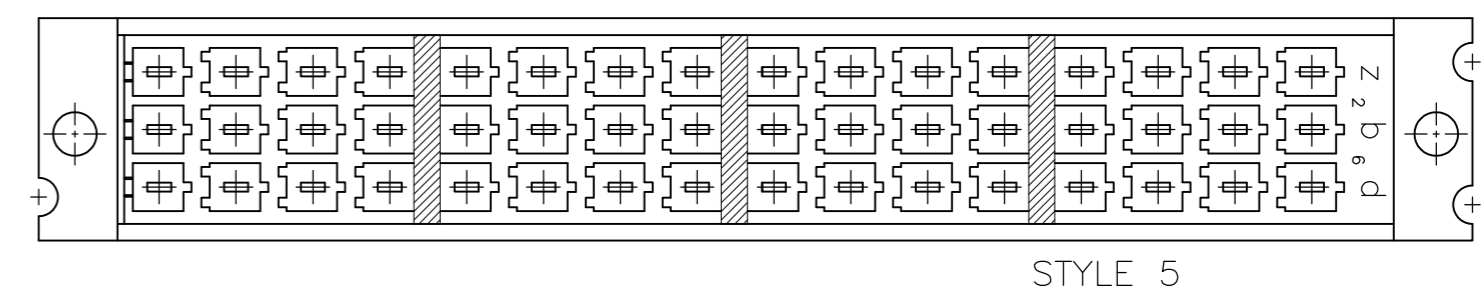
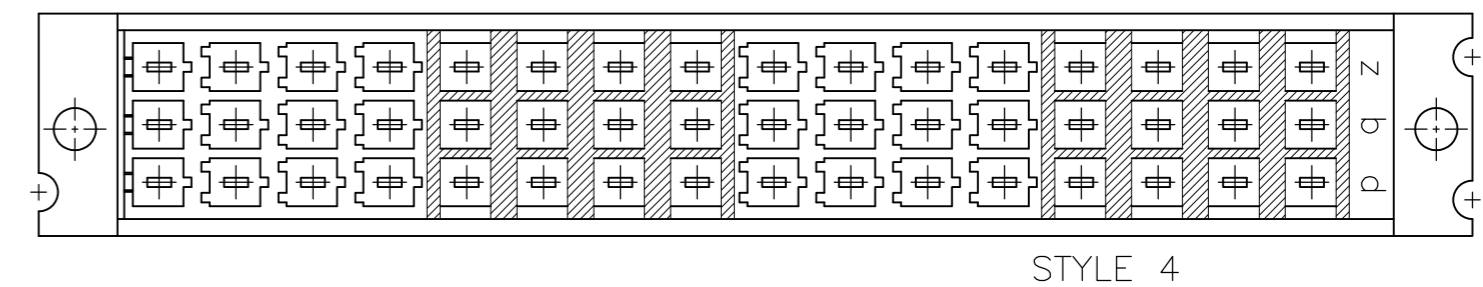
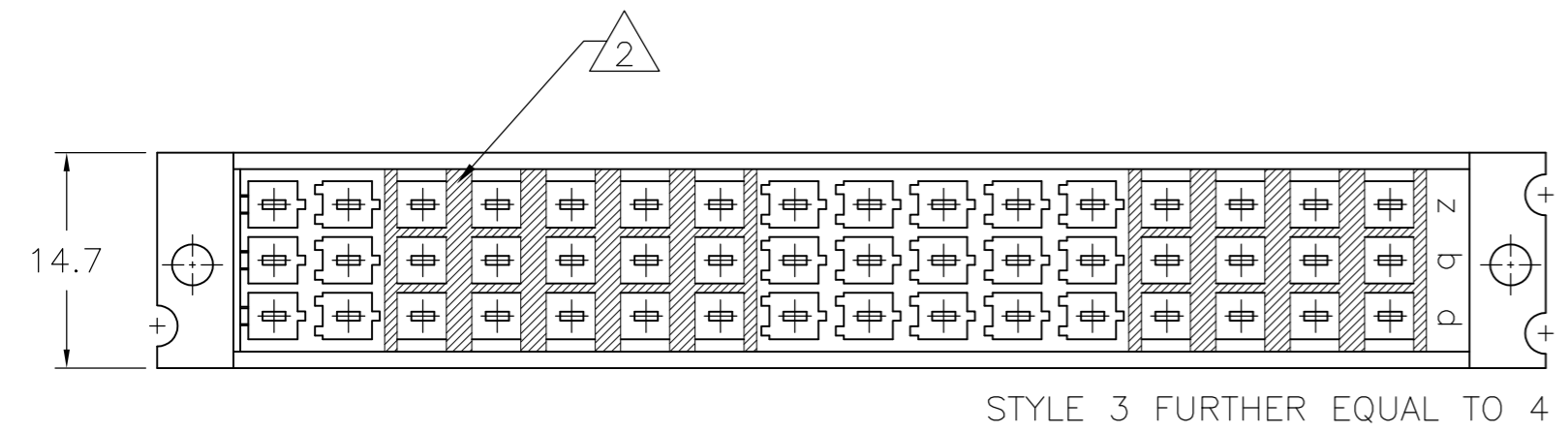
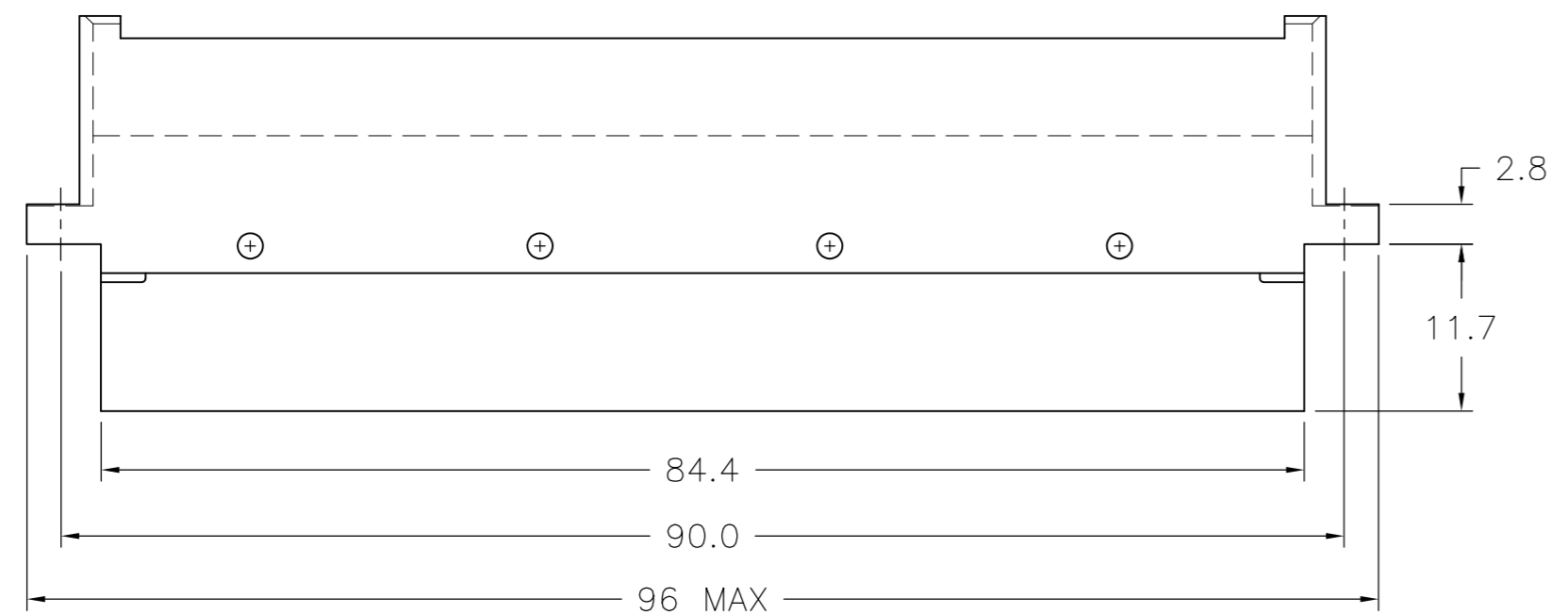

	5	1-166570-0
OBSOLETE	4	166570-9
	3	166570-8
OBSOLETE	1	166570-7
	2	166570-1
	STYLE	PART NUMBER

THIS DRAWING IS A CONTROLLED DOCUMENT.		DWN	B.CARBO	16JAN2013		TE Connectivity						
DIMENSIONS: mm		CHK	R.PATTERSON	16JAN2013		NAME						
TOLERANCES UNLESS OTHERWISE SPECIFIED:		APVD	R.PATTERSON	16JAN2013		48 POS, MALE CONN ASSY, FOR COSI CONTACTS, ACC. DIN 41612						
0 PLC ± - 1 PLC ± - 2 PLC ± .02 3 PLC ± .005 4 PLC ± .0005 ANGLES ± - FINISH -		PRODUCT SPEC	-			SIZE	A2	CAGE CODE	00779	DRAWING NO	C=166570	RESTRICTED TO
MATERIAL 1		WEIGHT	-		SCALE	2:1		SHEET	1 of 1		REV	D2
CUSTOMER DRAWING												