

Introduction

The ISL6263AEVAL1Z and ISL6263BEVAL1Z evaluation boards demonstrate the performance of the ISL6263A and ISL6263B respectively. The ISL6263A and ISL6263B are single-phase synchronous buck PWM controllers, which feature Intersil's Robust Ripple Regulator (R³) technology. The evaluation board design criteria is located in Table 1. An on-board dynamic-load generator is included for evaluating the transient-load response. The dynamic-load applies a 2.5ms pulse of 200mΩ across V_{OUT} and GND every 30ms.

What's Inside

Contents of this document include:

- Recommended Test Equipment
- Interface Connections
- Switch Descriptions
- Jumper Descriptions
- Test Point Descriptions
- Schematic
- Bill of Materials
- Silkscreen Plots
- Board Layout Plots

TABLE 1. EVALUATION BOARD DESIGN CRITERIA

PARAMETER	VALUE	UNITS
VIN	5 to 25	V _{DC}
VOUT	0.41200 to 1.28750	V _{DC}
DROOP	8	mΩ
FULL-LOAD	12	A _{DC}
PWM FREQUENCY	300	kHz
OCP	~15.5	A _{DC}

Recommended Equipment

- (QTY 1) Adjustable 25V, 5A Power Supply
- (QTY 1) Fixed 12V, 100mA Power Supply
- (QTY 1) Fixed 5V, 100mA Power Supply
- (QTY 1) Adjustable 20A Constant Current Electronic Load
- (QTY 1) Digital Multi-Meter
- (QTY 1) Four-Channel Oscilloscope

Interface Connections

- VIN: Input voltage to the power stage of the converter
 - J6: VIN positive power input
 - P37: VIN positive voltage sense
 - J5: VIN return power input
 - P38: VIN return voltage sense
- VOUT: Regulated output voltage from the converter
 - J14: VOUT positive power output
 - P5: VOUT positive voltage sense
 - J13: VOUT return power output
 - P9: VOUT return voltage sense
- 5V: +5V input voltage for VCC, PVCC, PGOOD-LED and pull-up voltage rail
 - J1: 5V positive input
 - J2: 5V return input
- 3.3V: +3.3V input voltage for auxiliary circuits
 - J3: 3.3V positive input
 - J4: 3.3V return input
- +12V: +12V input voltage for the dynamic-load generator
 - J11: 12V positive input
 - J12: 12V return input

Jumper Descriptions

- J7 (SRIP) — Selects the logic state of the AF_EN pin
 - Install shunt jumper across pins 1 and 2 for HIGH
 - Install shunt jumper across pins 2 and 3 for LOW (default)
- J9 — PGOOD circuit 5V input
 - Shunt jumper installed during normal operation (default)
 - Shunt jumper can be removed during efficiency tests
- J10 — Selects the logic state of the FDE pin
 - Install shunt jumper across pins 1 and 2 for HIGH
 - Install shunt jumper across pins 2 and 3 for LOW (default)
- J16 — VDD input current measurement port
 - Shunt jumper installed during normal operation (default)
 - Shunt jumper replaced by DMM to measure VDD bias current
- J17 — VDD and PVCC input current measurement port
 - Shunt jumper installed during normal operation (default)
 - Shunt jumper replaced by DMM to measure VDD bias current and PVCC bias current
- J18 — PGOOD and pull-up supply selection
 - Install shunt jumper across pins 1 and 2 for 5V (default)
 - Install shunt jumper across pins 2 and 3 for 3.3V (3.3V power supply should be connected to J3 and J4)

Switch Descriptions

- S1 — VIDs inputs (default <00000>)
- S4 — VR_ON (enable)
 - OFF — Converter is not enabled (default)
 - ON — Converter is enabled
- S5 — Transient load generator
 - OFF — Transient load is not enabled (default)
 - ON — Transient load is enabled

Test Point Descriptions

- PMON
 - — IMON test point for ISL6263A
 - — PMON test point for ISL6263B
- P1 (SRIP) — AF_EN
- P3 — DROOP
- P4 — COMP
- P5 — VOUT positive voltage sense
- P6 — PGOOD
- P7 — OCSET
- P8 — VW
- P9 — VOUT return voltage sense
- P11 — VSEN
- P12 — FB
- P13 — VSS
- P14 — SOFT
- P16 — FDE
- P17 — VDIFF after R₃₀ network analyzer port
- P20 — VR_ON
- P21 — VDIFF
- P22 (VCCP) — VO
- P26 — VSS
- P29 — VIN
- P30 — VSUM
- P32 — VDD
- P34 (+5V) — PVCC
- P35 — UGATE
- P36 — LGATE
- P37 — VIN positive voltage sense
- P38 — VIN return voltage sense

- VIDs Test Points:

TABLE 2. VID TEST POINT DESCRIPTIONS

TEST POINT (SILKSCREEN)	FUNCTION DESCRIPTION
P25	VID4
P27	VID3
P28	VID2
P31	VID1
P33	VID0

- J20 — PHASE (for oscilloscope probe)
- J22 — VOUT positive voltage sense to VOUT return voltage sense (for oscilloscope probe)
- J23 — Transient load (for oscilloscope probe)

Resistor Current Sense Configuration

The evaluation board is pre-configured with inductor DCR current sense. It also provides the option of resistor current sense for more precise overcurrent protection and current monitor. Follow the following procedure to configure the resistor current sense:

- Step 1:* Replace R₆₀ with the current sense shunt resistor
- Step 2:* Remove R₅₀ and R₅₃
- Step 3:* Place R₅₂ and R₅₄ with 0Ω resistors
- Step 4:* Follow the datasheet to configure other resistor current sense and overcurrent protection components.

Dynamic Load Generator

The evaluation board provides an on-board dynamic load generator for evaluating the transient-load response, which is controlled by switch S4. The dynamic load generator applies a 2.5ms pulse load across V_{OUT} and GND. The transient load slew-rate can be trimmed by adjusting the resistor R₇₄ for the rising edge, and resistor R₇₃ for the falling edge. A +12V power supply is needed to power the dynamic load generator.

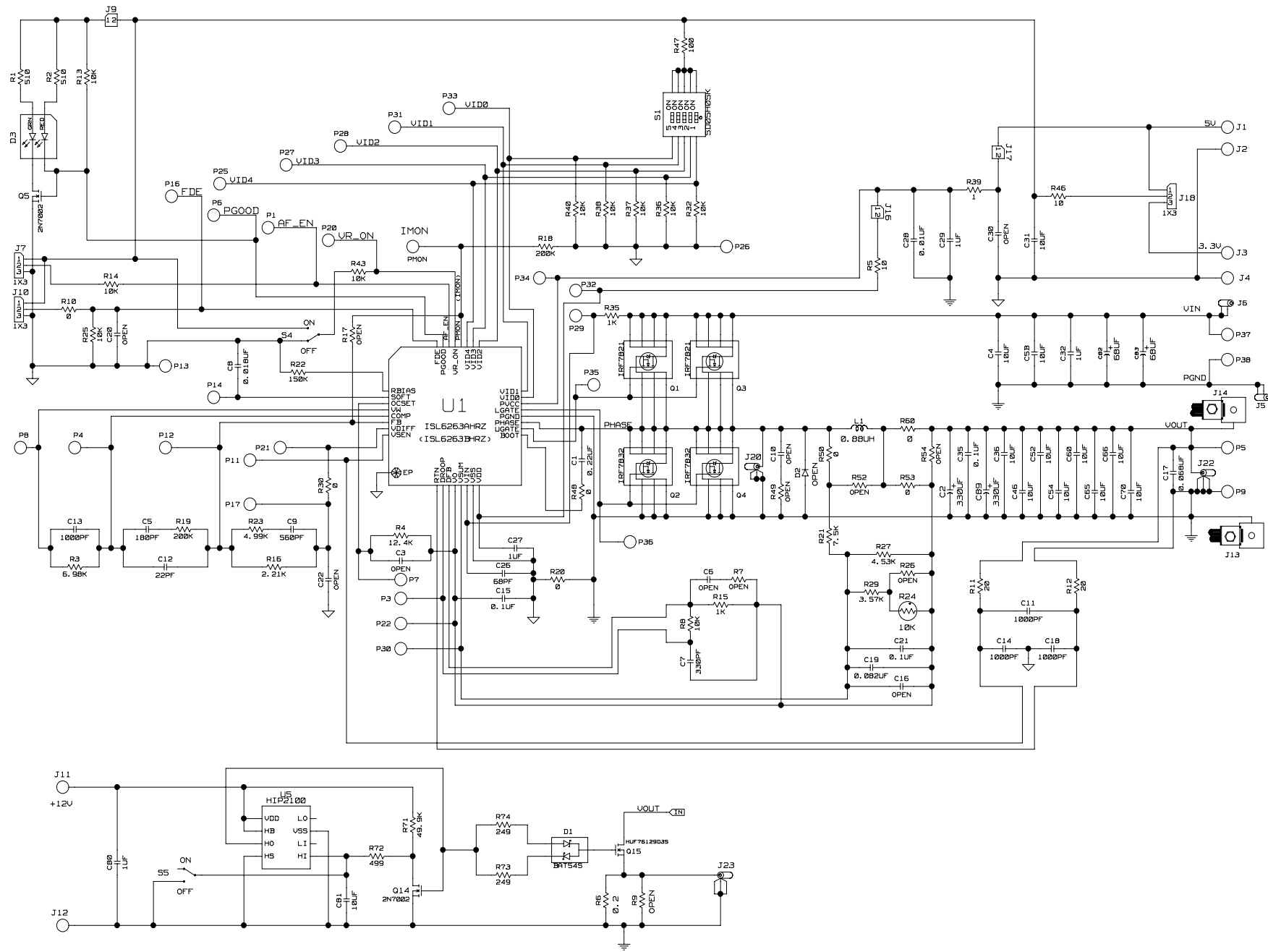

FIGURE 1. ISL6263AEVAL1Z AND ISL6263BEVAL1Z EVALUATION BOARDS SCHEMATIC

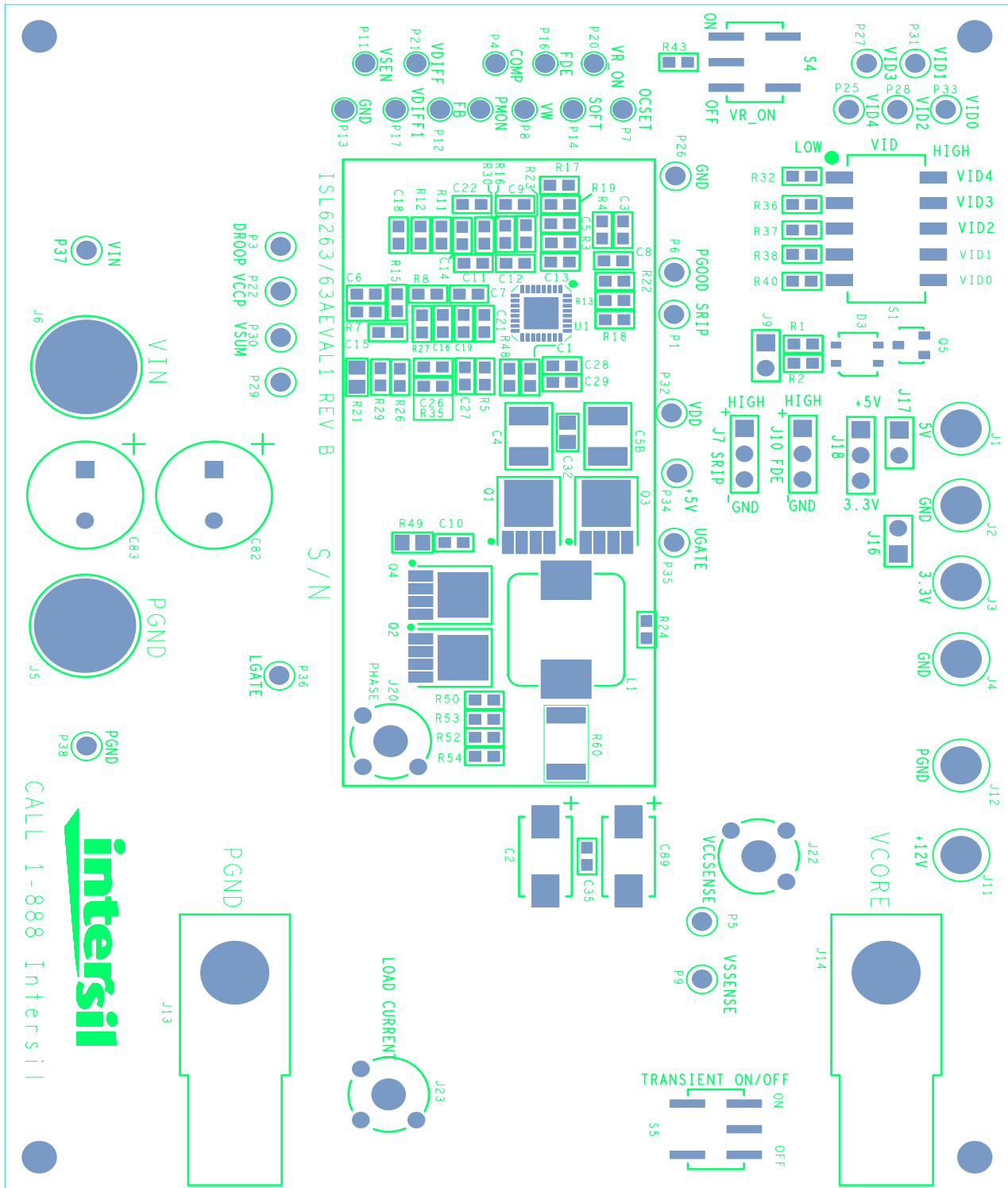

FIGURE 2. ISL6263AEVAL1Z AND ISL6263BEVAL1Z EVALUATION BOARDS PCB TOP SILKSREEN

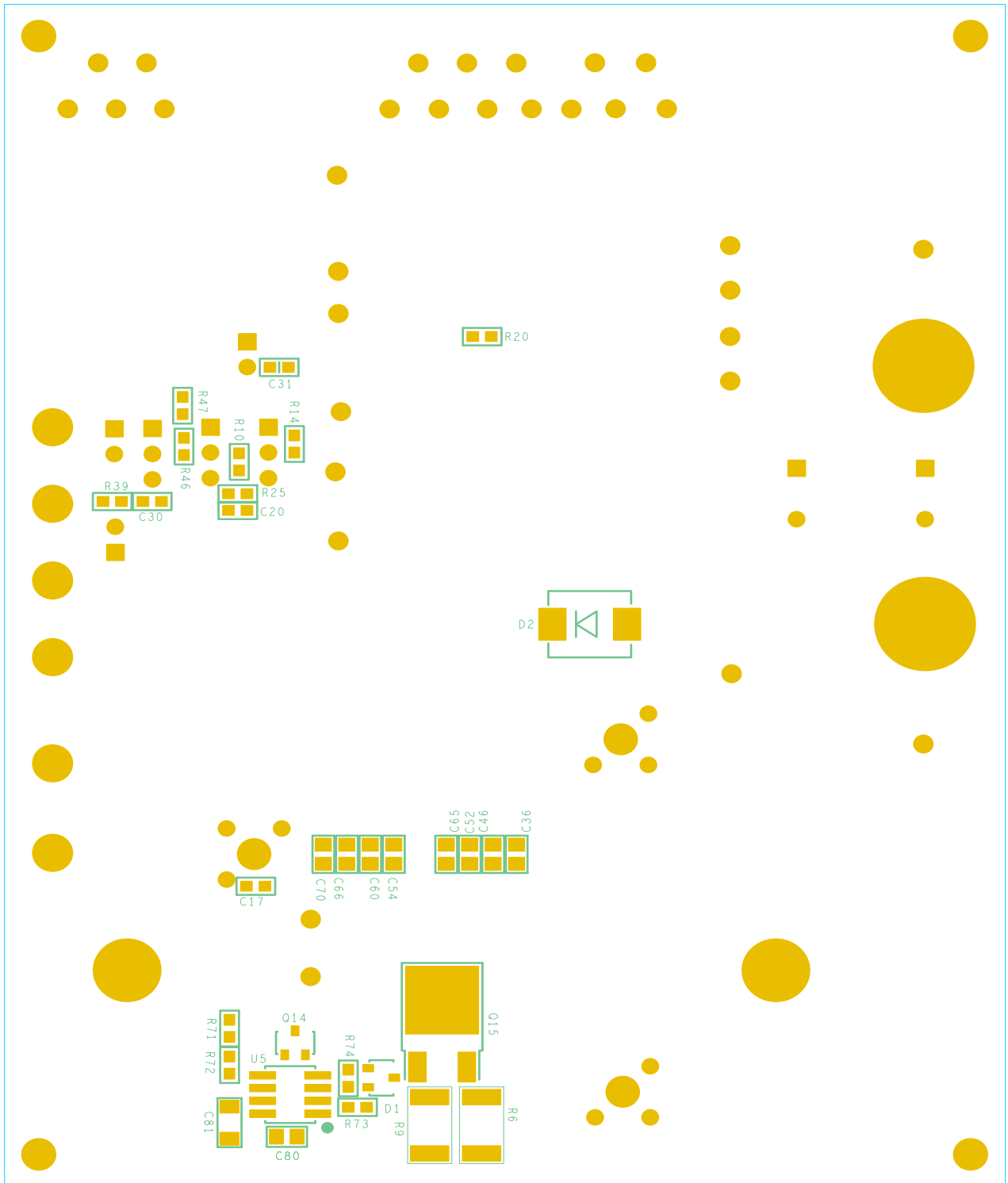

FIGURE 3. ISL6263AEVAL1Z and ISL6263BEVAL1Z EVALUATION BOARDS PCB BOTTOM SILKSCREEN

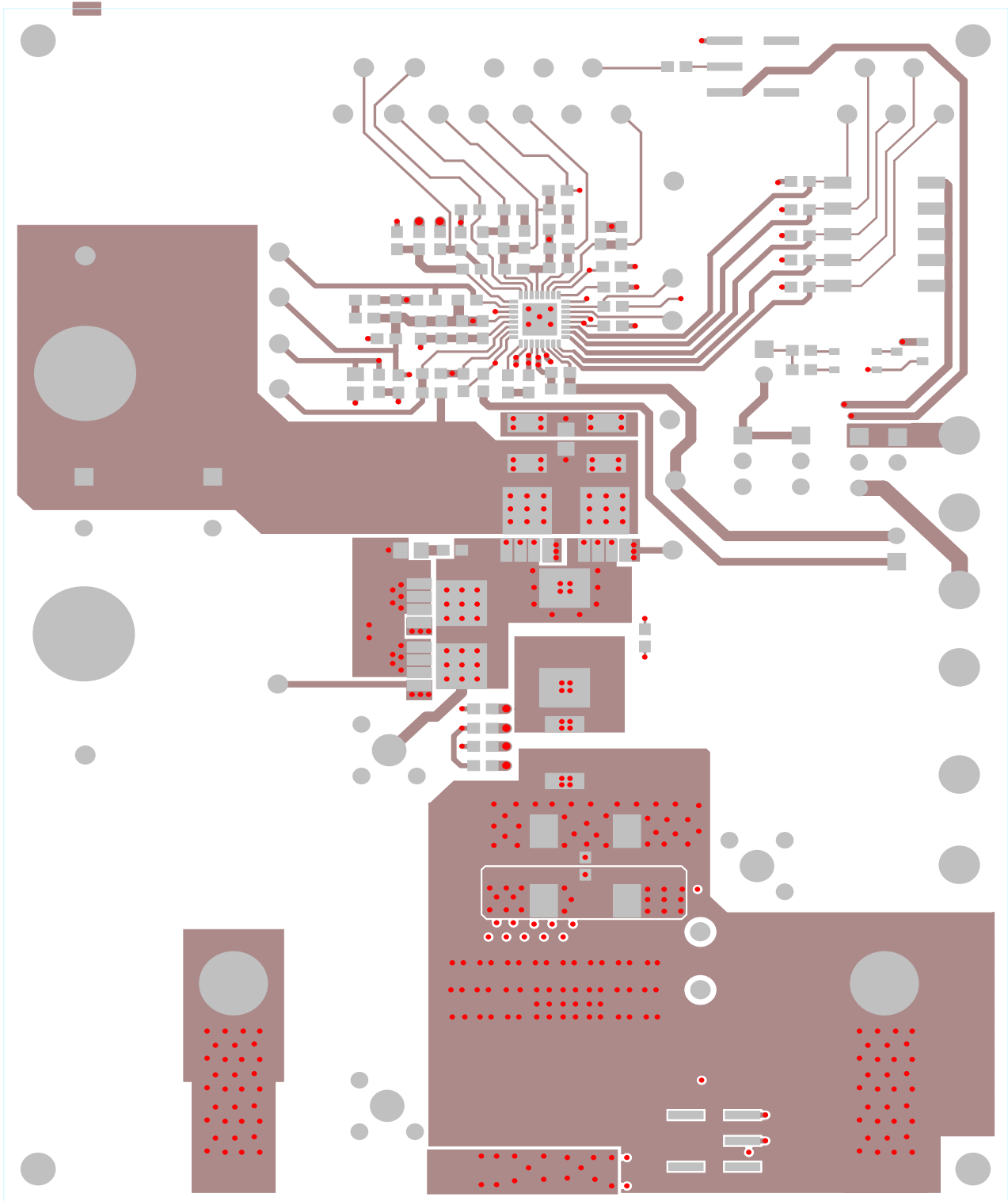

FIGURE 4. ISL6263AEVAL1Z and ISL6263BEVAL1Z EVALUATION BOARDS PCB TOP ETCH

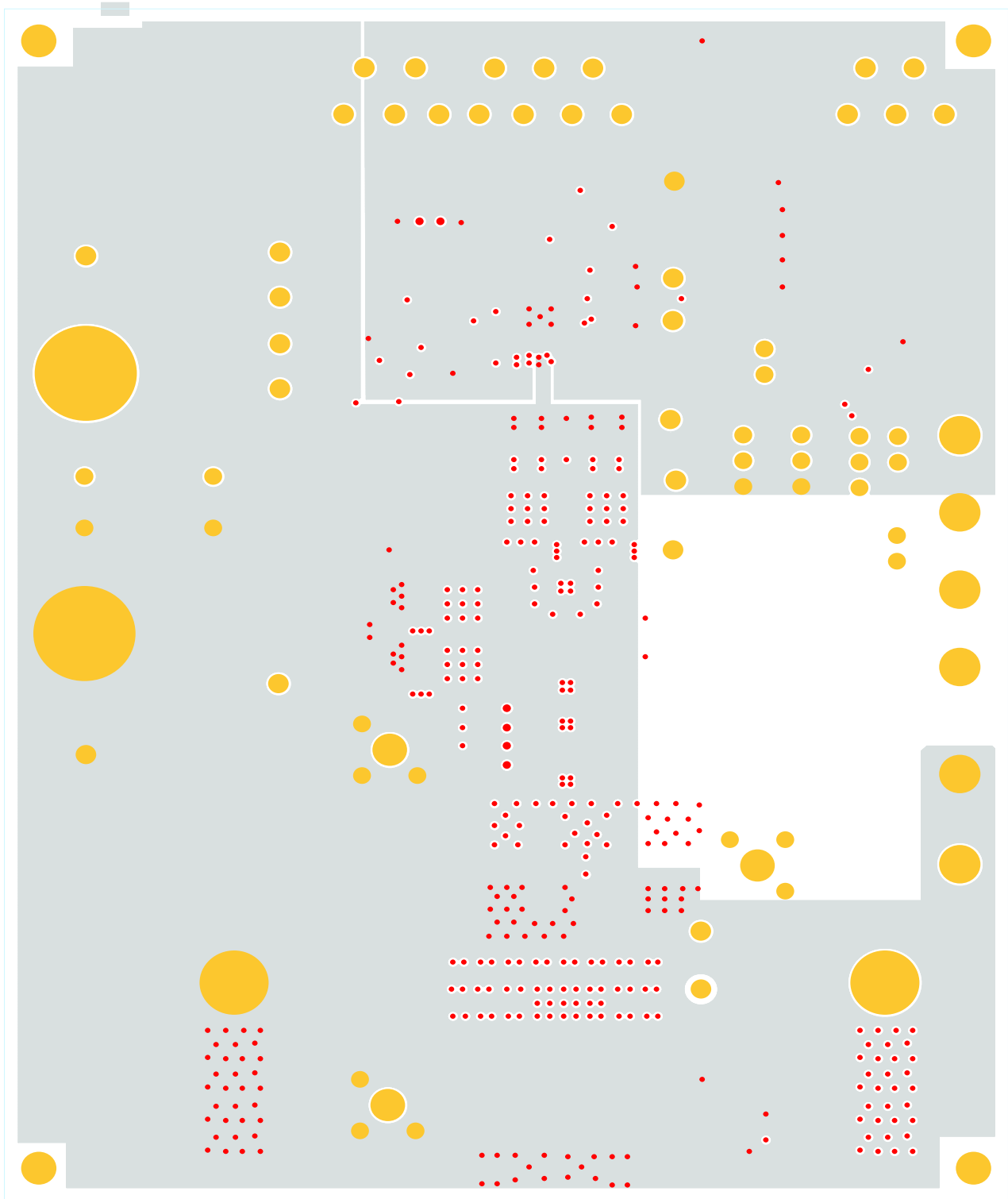

FIGURE 5. ISL6263AEVAL1Z and ISL6263BEVAL1Z EVALUATION BOARDS LAYER 2 ETCH

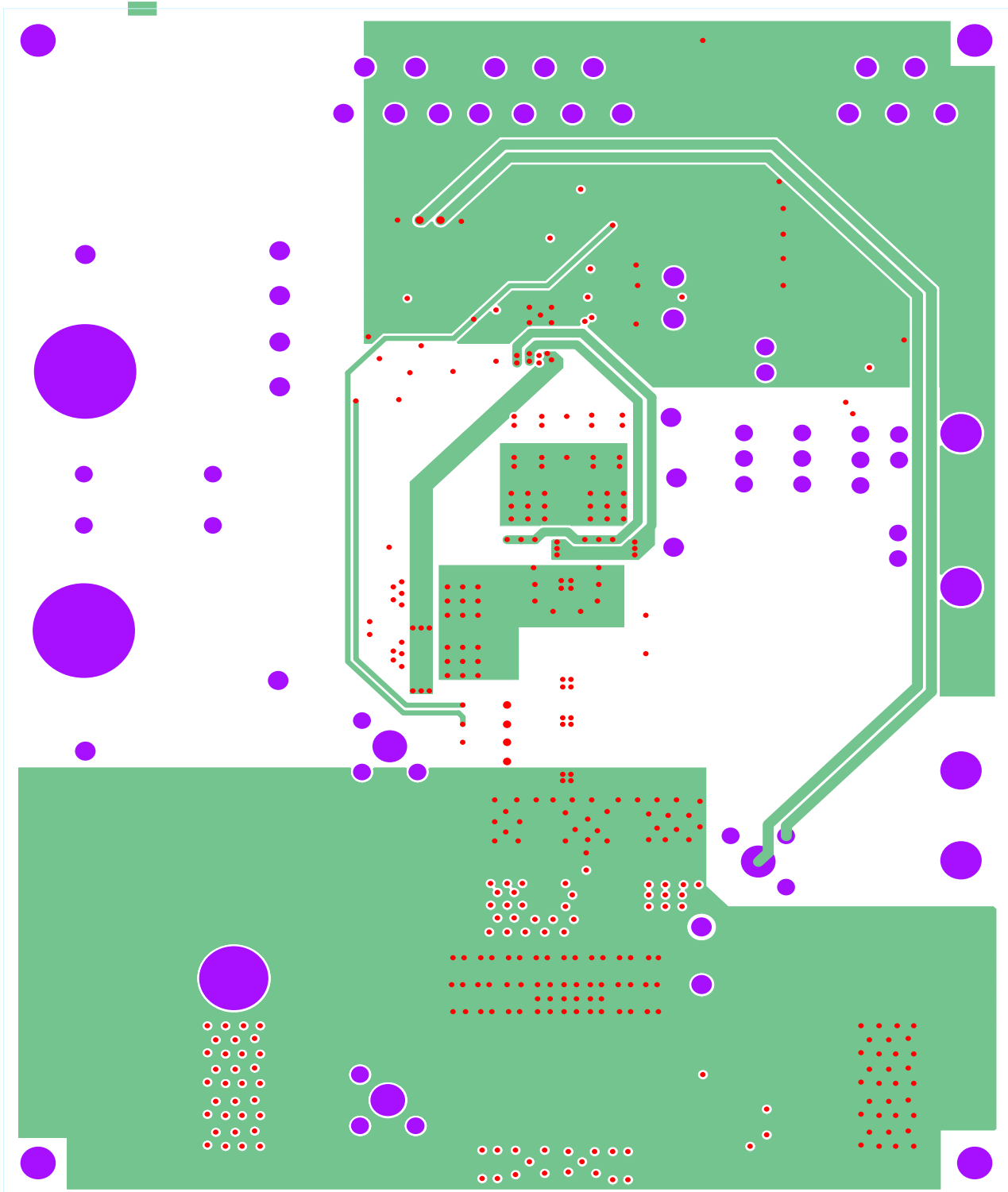

FIGURE 6. ISL6263AEVAL1Z and ISL6263BEVAL1Z EVALUATION BOARDS PCB LAYER 3 ETCH

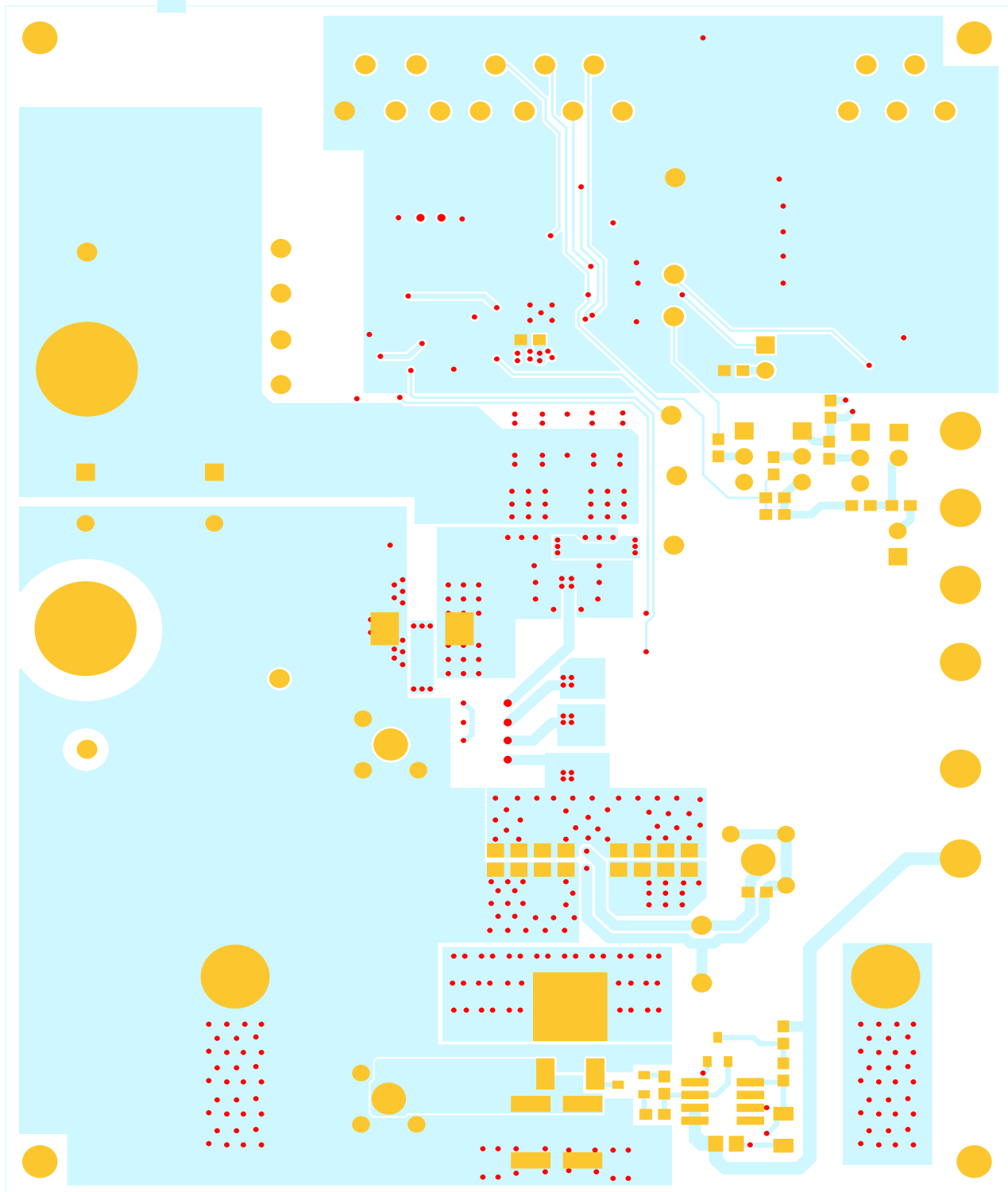

FIGURE 7. ISL6263AEVAL1Z AND ISL6263BEVAL1Z EVALUATION BOARDS PCB BOTTOM ETCH

Application Note 1486

Bill of Materials

ISL6263AEVAL1Z and ISL6263BEVAL1Z evaluation boards use the same PCB and schematic, thus the same bill of materials except for the controller.

NO.	REFERENCE	QTY	DESCRIPTION	MFG NAME	MFG PART NUMBER
1	C82, C83	2	CAP, RADIAL, 68μF, 100V, 20%, ALUM.ELECTROLYTIC	PANASONIC	EEU-FC2A680L
2	C11, C13, C14, C18	4	CAP, SMD, 0603, 1000pF, 16V, 10%, X7R	GENERIC	NA
3	C28	1	CAP, SMD, 0603, 0.01μF, 16V, 10%, X7R	GENERIC	NA
4	C15, C21, C35	3	CAP, SMD, 0603, 0.1μF, 25V, 10%, X7R	GENERIC	NA
5	C27, C29	2	CAP, SMD, 0603, 1μF, 6.3V, 10%, X5R	GENERIC	NA
6	C5	1	CAP, SMD, 0603, 180pF, 10V, 10%, X7R	GENERIC	NA
7	C1	1	CAP, SMD, 0603, 0.22μF, 25V, 20%, X7R	GENERIC	NA
8	C7	1	CAP, SMD, 0603, 330pF, 10V, 5%, NPO	GENERIC	NA
9	C9	1	CAP, SMD, 0603, 560pF, 10V, 10%, X7R	GENERIC	NA
10	C12	1	CAP, SMD, 0603, 22pF, 10V, 5%, NPO	GENERIC	NA
11	C26	1	CAP, SMD, 0603, 68pF, 50V, 5%, NPO	GENERIC	NA
12	C17	1	CAP, SMD, 0603, 0.068μF, 16V, 10%, X7R	GENERIC	NA
13	C19	1	CAP, SMD, 0603, 0.082μF, 16V, 10%, X7R	GENERIC	NA
14	C8	1	CAP, SMD, 0603, 0.018μF, 10V, 10%, X7R	GENERIC	NA
15	C32, C80	2	CAP, SMD, 0805, 1.0μF, 25V, 10%, X7R	GENERIC	NA
16	C31, C36, C46, C52, C54, C60, C65, C66, C70	9	CAP, SMD, 0805, 10μF, 6.3V, 10%, X5R	GENERIC	NA
17	C81	1	CAP, SMD, 1206, 10μF, 16V, 20%, X5R	GENERIC	NA
18	C4, C5B	2	CAP, SMD, 1812, 10μF, 25V, 10%, X5R	GENERIC	NA
19	C2, C89	2	CAP, SMD, 330μF, 2V, 20%, SP-CAP	PANASONIC	EEF-SX0D331XR
20	L1	1	INDUCTOR, SMD, 11.5X10, 0.88μH, 20%, 17.4A	NEC/TOKIN	MPC1040LR88
21	U5	1	IC-HI FREQ BRIDGE DRIVER, SO8, 100V	INTERSIL	HIP2100IB
22	U1	1	PWM CONTROLLER, 32P, QFN, 5x5	INTERSIL	ISL6263AHRZ or ISL6263BHRZ
23	R24	1	NTC, SMD, 0603, 10k, 1/10W, 5%, B VALUE = 4201k to 4300k	PANASONIC	ERT-J1VR103J
24	Q5, Q14	2	MOSFET, N-CH, SOT23, 60V, 115mA	MOTOROLA	2N7002LT1
25	Q15	1	MOSFET, N-CH, TO-252AA, 30V, 16mΩ	FAIRCHILD	HUF76129D3S
26	Q1	1	MOSFET, N-CH, SO8, 30V, 9.1mΩ	IR	IRF7821
27	Q2, Q4	2	MOSFET, N-CH, SO8, 30V, 4.0mΩ	IR	IRF7832
28	R39	1	RES, SMD, 0603, 1Ω, 1/10W, 1%	GENERIC	NA
29	R5, R46	2	RES, SMD, 0603, 10Ω, 1/10W, 1%	GENERIC	NA
30	R11, R12	2	RES, SMD, 0603, 20Ω, 1/16W, 1%	GENERIC	NA
31	R10, R20, R30, R48, R50, R53	6	RES, SMD, 0603, 0Ω, 1/16W	GENERIC	NA
32	R47	1	RES, SMD, 0603, 100Ω, 1/10W, 1%	GENERIC	NA
33	R15, R35	2	RES, SMD, 0603, 1k, 1/10W, 1%	GENERIC	NA
34	R8, R13, R14, R25, R32, R36, R37, R38, R40, R43	10	RES, SMD, 0603, 10k, 1/10W, 1%,	GENERIC	NA

Application Note 1486

Bill of Materials

ISL6263AEVAL1Z and ISL6263BEVAL1Z evaluation boards use the same PCB and schematic, thus the same bill of materials except for the controller. (Continued)

NO.	REFERENCE	QTY	DESCRIPTION	MFG NAME	MFG PART NUMBER
35	R4	1	RES, SMD, 0603, 12.4k, 1/16W, 1%	GENERIC	NA
36	R22	1	RES, SMD, 0603, 150k, 1/16W, 1%	GENERIC	NA
37	R18, R19	2	RES, SMD, 0603, 200k, 1/16W, 1%	GENERIC	NA
38	R16	1	RES, SMD, 0603, 2.21k, 1/16W, 1%	GENERIC	NA
39	R73, R74	2	RES, SMD, 0603, 249Ω, 1/16W, 1%	GENERIC	NA
40	R29	1	RES, SMD, 0603, 3.57k, 1/16W, 1%	GENERIC	NA
41	R27	1	RES, SMD, 0603, 4.53k, 1/16W, 1%	GENERIC	NA
42	R72	1	RES, SMD, 0603, 499Ω, 1/16W, 1%	GENERIC	NA
43	R23	1	RES, SMD, 0603, 4.99k, 1/16W, 1%	GENERIC	NA
44	R71	1	RES, SMD, 0603, 49.9k, 1/16W, 1%	GENERIC	NA
45	R1, R2	2	RES, SMD, 0603, 510Ω, 1/16W, 5%	GENERIC	NA
46	R3	1	RES, SMD, 0603, 6.98k, 1/16W, 1%	GENERIC	NA
47	R21	1	RES, SMD, 0603, 7.5k, 1/16W, 1%	GENERIC	NA
48	R60	1	RES, SMD, 2512, 0Ω, 1W, 5%	GENERIC	NA
49	R6	1	RES, SMD, 2512, 0.2Ω, 1W, 1%	DALE	WSL-2512-R200F
50	S4, S5	2	SWITCH-TOGGLE, SMD, 1P, SPST	C&K COMPONENTS	GT11MSCKE
51	S1	1	SWITCH-DIP, SMD, DIP, 5P, SLIDE, SPST	C&K COMPONENTS	SD05H0SK
52	D1	1	SCHOTTKY, SMD, SOT23, 3P, 30V, 200mA, DUAL DIODE	FAIRCHILD	BAT54S
53	D3	2	LED, SMD, 3x2.5mm, 4P, RED/GREEN, 12/20MCD, 2V	LUMEX	SSL-LXA3025IGC-TR
54	C3, C6, C10, C16, C20, C22, C30, R7, R9, R17, R26, R49, R52, R54, D2, Q3	16	OPEN		

Intersil Corporation reserves the right to make changes in circuit design, software and/or specifications at any time without notice. Accordingly, the reader is cautioned to verify that the Application Note or Technical Brief is current before proceeding.

For information regarding Intersil Corporation and its products, see www.intersil.com