



PART NAME

PTH MOUNTING PLATE (STEEL)

PART No.

PTX-22510

REVISION DATE

10-20-17

DRAWING FOR REFERENCE
WE RESERVE THE RIGHT TO MAKE CHANGES TO OUR STANDARD PRODUCTS. PLEASE CONSULT WITH BUD INDUSTRIES PRIOR TO USING THIS DRAWING FOR DESIGN PURPOSE.

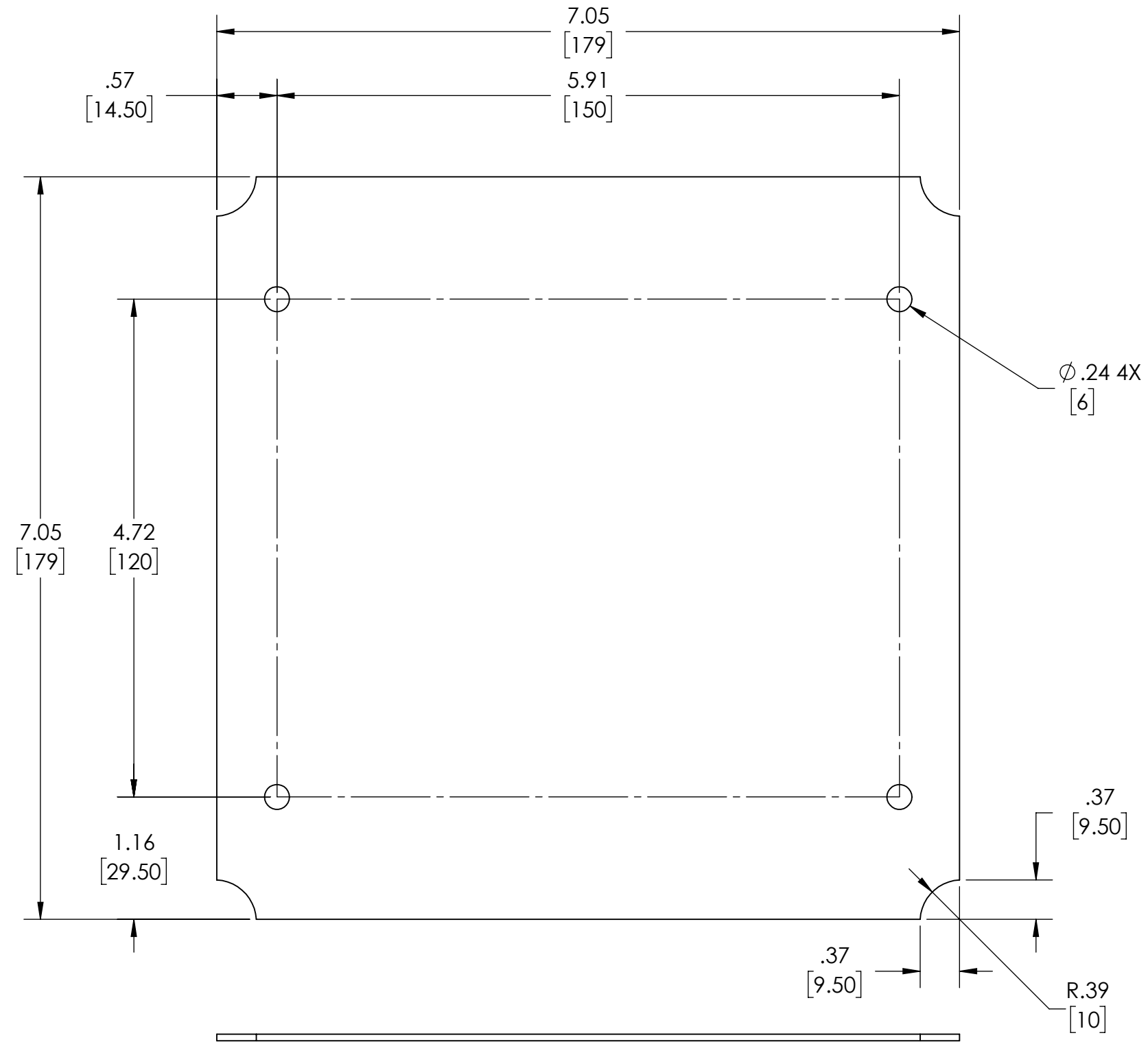

MATERIAL - .063 [1.6mm] THK. STEEL, ZINC PLATE
DIMENSIONS ARE INCH[MM]
PANEL FITS THE FOLLOWING ENCLOSURES:
PTH-22510 & PTH-22510-C