

**DSU-FR EMULATOR**  
**LQFP-144P HEADER TYPE 9**  
**MB2198-161-E**  
**OPERATION MANUAL**

## PREFACE

Thank you for purchasing the LQFP-144P\*<sup>1</sup> header type 9 for the DSU-FR\*<sup>2</sup> emulator (model number : MB2198-161-E).

The MB2198-161-E is used with the adapter unit for connecting to user systems that use the MB91 (F) 475 (LQFP-144P) series of Fujitsu FR microcontrollers, together with the DSU-FR emulator (model number : MB2198-01-E)\*<sup>3</sup> and DSU-FR cable (model number : MB2198-10-E)\*<sup>4</sup>.

The manual explains how to handle the MB2198-161-E. Before using the MB2198-161-E, be sure to read this manual.

Please contact sales or support representative for details on the mass production and evaluation MCU models that can be used with this product.

\*1 : Uses the FPT-144P-M12 package (lead pitch: 0.4mm, body size: 16mm × 16mm)

\*2 : FR, the abbreviation of FUJITSU RISC controller, is a line of products of FUJITSU MICRO-ELECTRONICS Limited.

\*3 : Referred to as “emulator”.

\*4 : Referred to as “DSU cable”.

### ■ Handling and Use

Please refer to the following manuals for information about how to handle and use this product and also for details on safety precautions.

- DSU-FR EMULATOR MB2198-01-E OPERATION MANUAL
- DSU-FR EMULATOR DSU-FR CABLE MB2198-10-E OPERATION MANUAL
- DSU-FR EMULATOR BGA-224P ADAPTER MB2198-160-E OPERATION MANUAL

### ■ European RoHS Compliance

Products with a “-E” suffix on the part number are European RoHS compliant products.

### ■ Notice on this document

All information included in this document is current as of the date it is issued. Such information is subject to change without any prior notice.

Please confirm the latest relevant information with the sales representatives.

### ■ Cautions Regarding the Products Described in this Document

The following precautions apply to the product described in this manual.



Indicates a feature that, if not used correctly, may result in minor or moderate injuries, and which may cause the customer system to malfunction.

<b>Cuts</b>	This product has parts with sharp points that are exposed. Do not touch edge of the product with your bare hands.
<b>Damage</b>	When connect the header board to the user system, correctly position the index mark (▲) on the NQPACK mounted on the user system with the index mark (▲) on the header board, otherwise the emulator system and user system might be damaged.
<b>Damage</b>	When mounting a mass production MCU, correctly position pin 1, otherwise the mass production MCU and user system might be damaged.

- The contents of this document are subject to change without notice. Customers are advised to consult with sales representatives before ordering.
- The information, such as descriptions of function and application circuit examples, in this document are presented solely for the purpose of reference to show examples of operations and uses of FUJITSU MICROELECTRONICS semiconductor device; FUJITSU MICROELECTRONICS does not warrant proper operation of the device with respect to use based on such information. When you develop equipment incorporating the device based on such information, you must assume any responsibility arising out of such use of the information. FUJITSU MICROELECTRONICS assumes no liability for any damages whatsoever arising out of the use of the information.
- Any information in this document, including descriptions of function and schematic diagrams, shall not be construed as license of the use or exercise of any intellectual property right, such as patent right or copyright, or any other right of FUJITSU MICROELECTRONICS or any third party or does FUJITSU MICROELECTRONICS warrant non-infringement of any third-party's intellectual property right or other right by using such information. FUJITSU MICROELECTRONICS assumes no liability for any infringement of the intellectual property rights or other rights of third parties which would result from the use of information contained herein.
- The products described in this document are designed, developed and manufactured as contemplated for general use, including without limitation, ordinary industrial use, general office use, personal use, and household use, but are not designed, developed and manufactured as contemplated (1) for use accompanying fatal risks or dangers that, unless extremely high safety is secured, could have a serious effect to the public, and could lead directly to death, personal injury, severe physical damage or other loss (i.e., nuclear reaction control in nuclear facility, aircraft flight control, air traffic control, mass transport control, medical life support system, missile launch control in weapon system), or (2) for use requiring extremely high reliability (i.e., submersible repeater and artificial satellite).  
Please note that FUJITSU MICROELECTRONICS will not be liable against you and/or any third party for any claims or damages arising in connection with above-mentioned uses of the products.
- Any semiconductor devices have an inherent chance of failure. You must protect against injury, damage or loss from such failures by incorporating safety design measures into your facility and equipment such as redundancy, fire protection, and prevention of over-current levels and other abnormal operating conditions.
- Exportation/release of any products described in this document may require necessary procedures in accordance with the regulations of the Foreign Exchange and Foreign Trade Control Law of Japan and/or US export control laws.
- The company names and brand names herein are the trademarks or registered trademarks of their respective owners.

# 1. Checking the Delivered Product

Before using the MB2198-161-E, confirm that the following components are included in the box:

- LQFP-144P Header type 9\*1 : 1
- Screws for securing the header board (M2 × 10mm, 0.4mm pitch) : 4
- Washer : 4
- NQPACK144SE\*2 : 1
- HQPACK144SE\*3 : 1
- Operation manual (Japanese version) : 1
- Operation manual (English version, this manual) : 1

\*1 : Referred to as "header board". A YQPACK144SE-4W (manufactured by Tokyo Eletech Corporation, referred to as the "YQPACK" in this manual) is mounted on the header board.

\*2 : The IC socket (manufactured by Tokyo Eletech Corporation, referred to as the "NQPACK" in this manual). The NQPACK includes a specialized screw driver and 3 guide pins. A more reliable compatible socket, the NQPACK144SE-SL (sold separately; manufactured by Tokyo Eletech Corporation), can be used by making a screw hole in the user system board for affixing the IC socket. For more information, contact Tokyo Eletech Corporation.

\*3 : The IC socket cover (manufactured by Tokyo Eletech Corporation, referred to as the "HQPACK" in this manual). The Includes 4 screws (M2 × 6mm, 0.4mm pitch) for attaching the HQPACK.

This product can function as an adapter unit when used in combination with an adapter board (sold separately). The product can also function as an emulator system when used in conjunction with an emulator.

For details about the emulators and adapter boards that support this product, contact our Sales Department or Support Department.

# 2. Handling Precautions

The adapter unit is precision-manufactured to improve dimensional accuracy and to ensure reliable contact, and is therefore mechanically weak.

Take the following precautions to ensure that the header board is always used correctly in an appropriate environment.

- Avoid placing any stress on the NQPACK that is mounted on the user system while the adapter unit is connected.

### 3. Notes on Designing

#### ■ Notes on Printed Circuit Board for the User System

Once the header board is connected to the user system, the heights of parts mounted in the space around the header board are restricted.

When the printed circuit board of the user system is designed, consider the height of the parts so that components mounted to the user system and the header board do not interfere within range of the header board as shown in Figure 1.

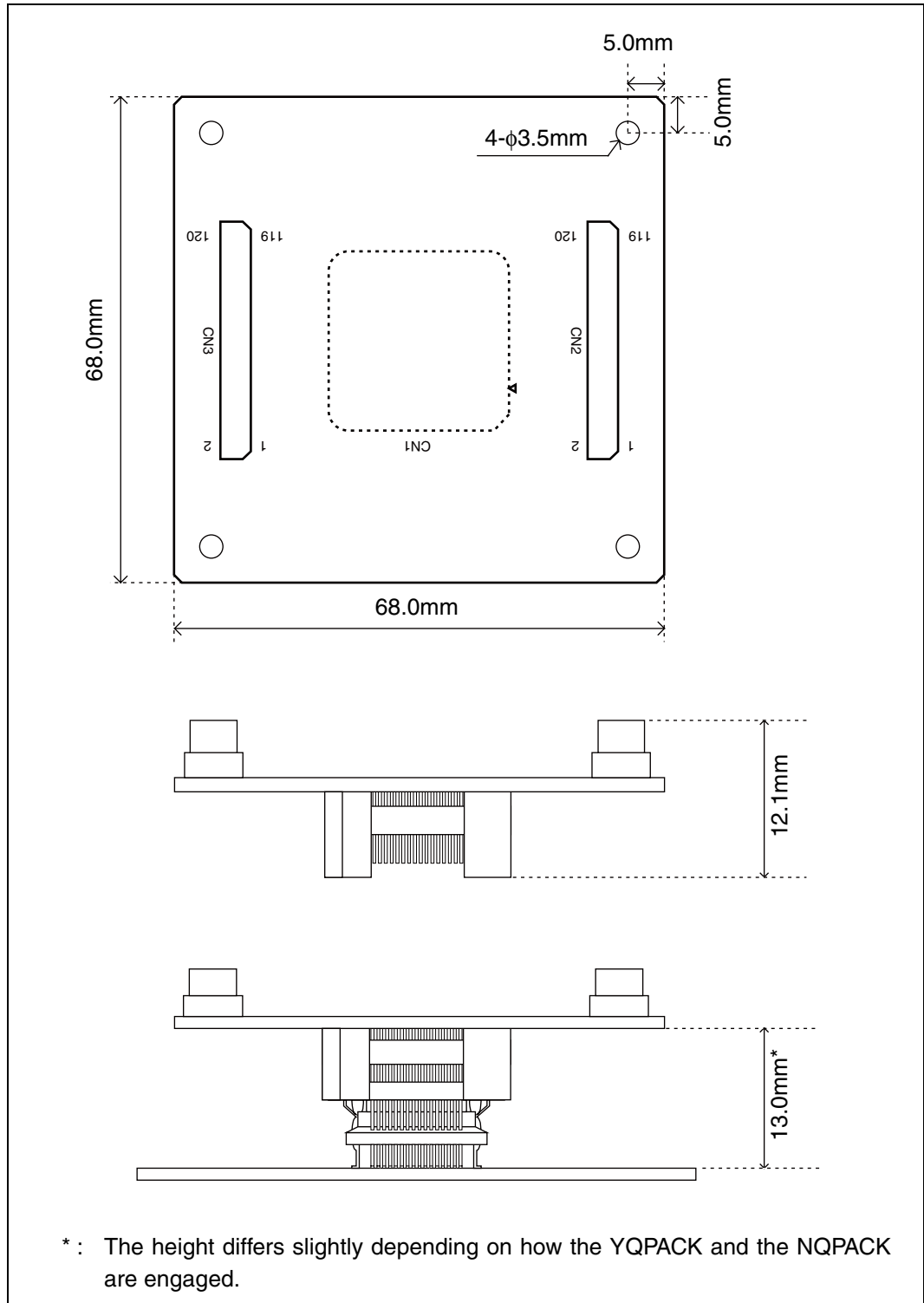
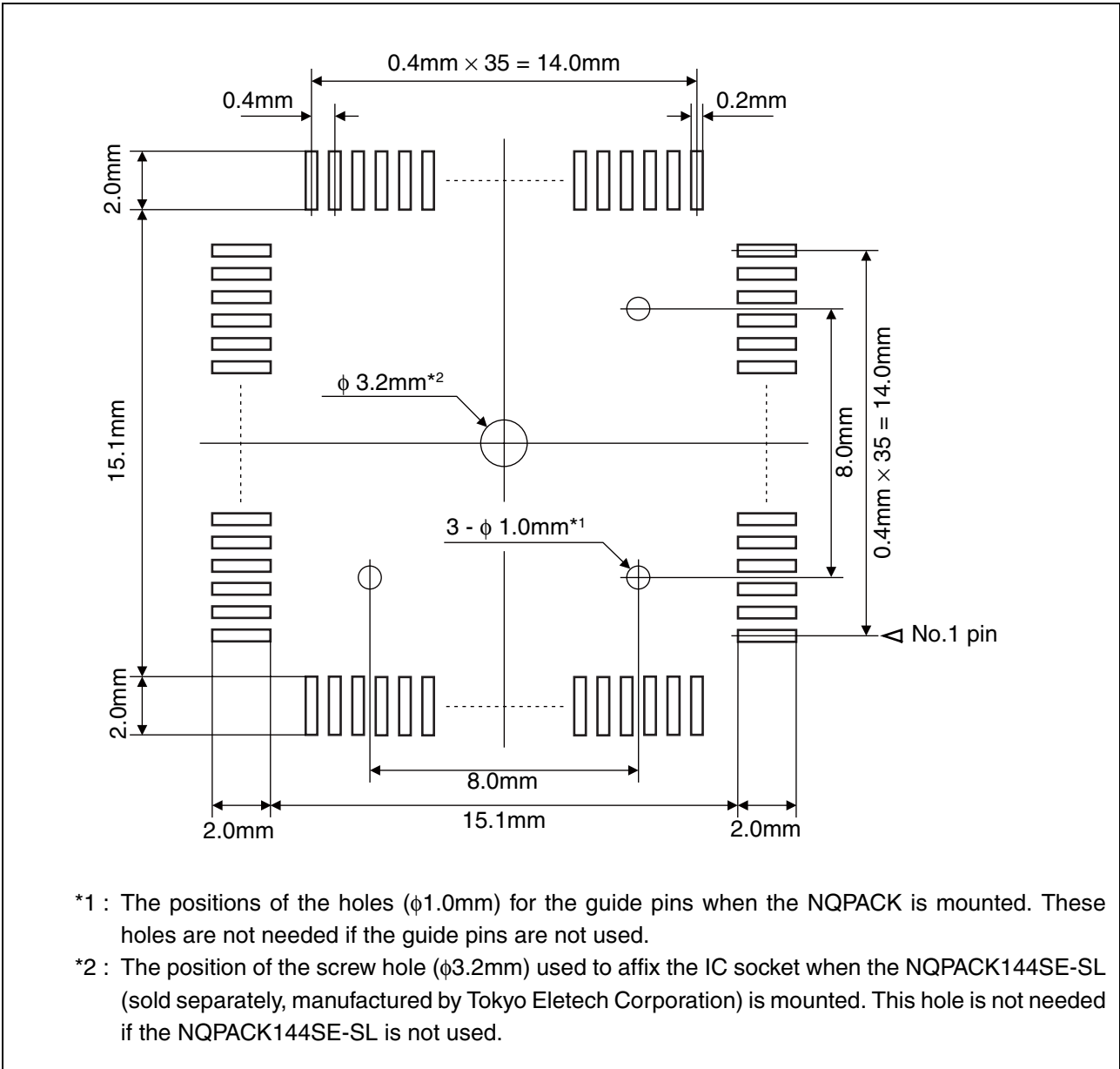

Figure 1 Header board dimensions

■ MCU Footprint Design Notes

Figure 2 shows the recommended dimensions of the footprint for mounting the NQPACK on the printed circuit board of the user system.  
 The printed circuit board of the user system must be designed with due consideration given to this footprint as well as to the mass production MCU.  
 For details on footprint, contact the Tokyo Eletech Corporation.



- \*1 : The positions of the holes ( $\phi 1.0\text{mm}$ ) for the guide pins when the NQPACK is mounted. These holes are not needed if the guide pins are not used.
- \*2 : The position of the screw hole ( $\phi 3.2\text{mm}$ ) used to affix the IC socket when the NQPACK144SE-SL (sold separately, manufactured by Tokyo Eletech Corporation) is mounted. This hole is not needed if the NQPACK144SE-SL is not used.

Figure 2 Recommended dimensions of the footprint for mounting the NQPACK

## 4. Connecting to the User System

Mount the attached NQPACK on the user system before using this product.  
The header board and adapter board are connected in a stack structure.

### ■ Connection

1. To connect the header board to the user system, match pin 1 indicated by the index mark (▲) on the NQPACK mounted on the user system with the index mark (▲) on the header board and then insert it (see “Figure 3”). The YQPACK pins are thin and easily bent. When you are connecting the YQPACK to the NQPACK, ensure that the YQPACK pins are not bent before pushing it all the way into the NQPACK.
2. Insert the screws for securing the header board through the washers into the four holes on the header board, and then tighten the screws in the opposite corners evenly using the special screw driver that was included with the NQPACK (see “Figure 4”).  
Be careful not to over-tighten the screws as this may result in bad connections.

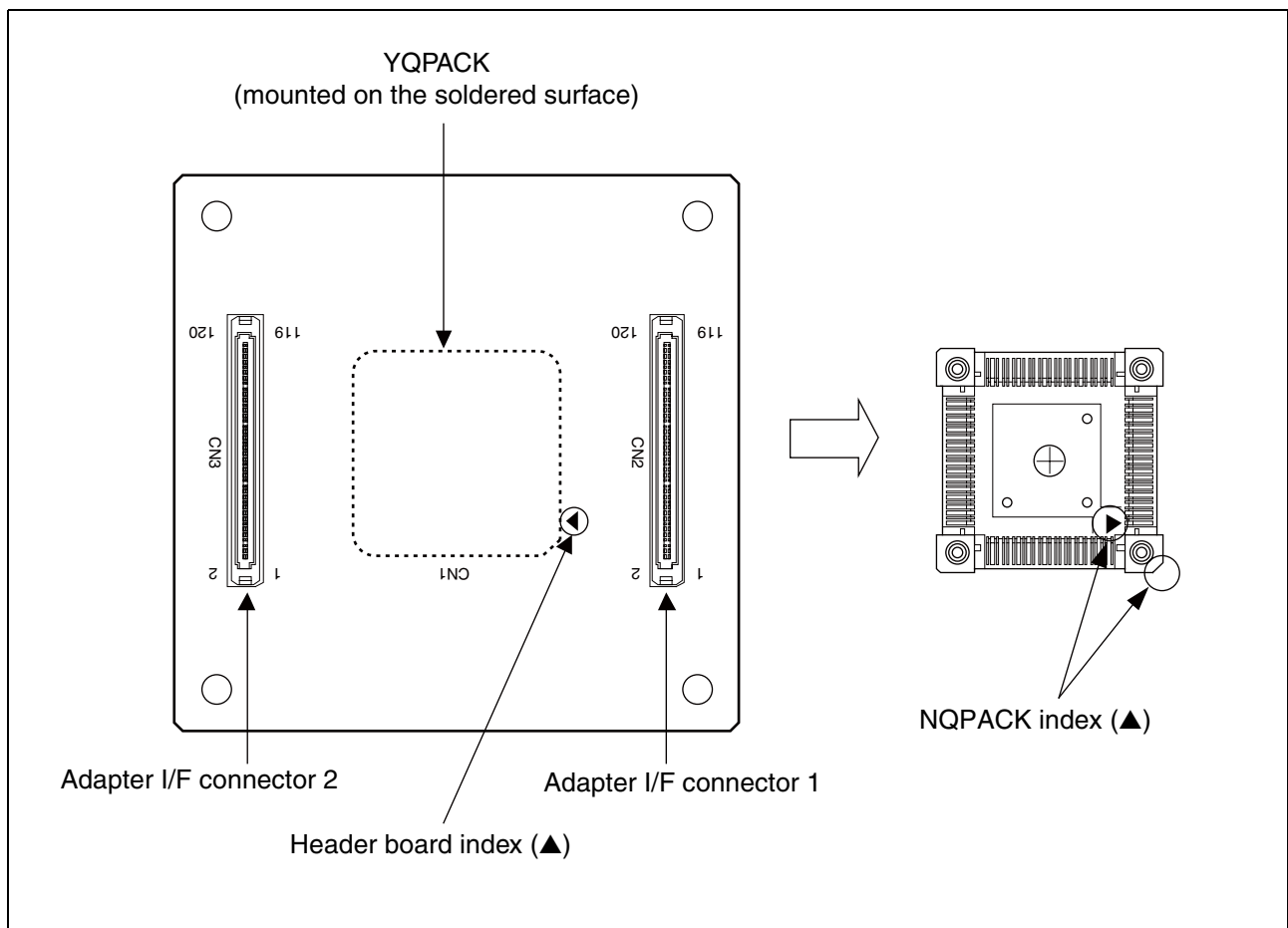

Figure 3 Index position

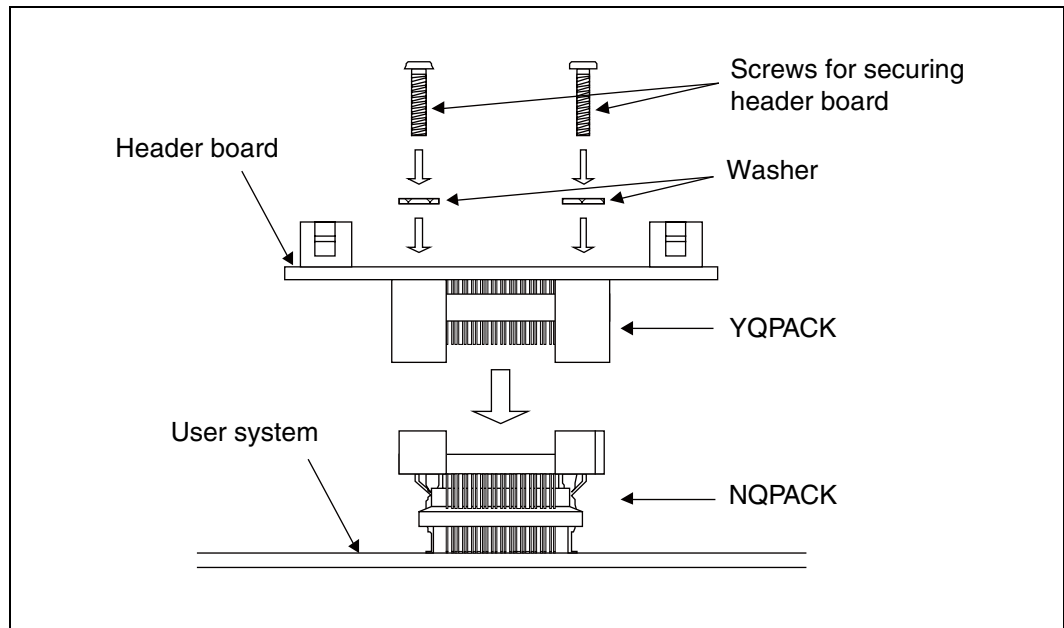

Figure 4 Header board connection

#### ■ Disconnection

To disconnect the header board from the user system, remove all four screws, and then pull the header board straight out of the socket.

## 5. Connecting to an Adapter Board

For information about how to connect the header board to the adapter board, refer to the operation manual for the adapter board from the NQPACK.



## 6. Mounting Mass Production MCUs

To mount a mass production MCU on the user system, use the supplied HQPACK.

### ■ Mounting

1. To mount a mass production MCU on the user system, match the index mark (▲) on the NQPACK mounted on the user system with the index mark (●) on the mass production MCU.
2. Confirm that the mass production MCU is correctly mounted on the NQPACK, and then align the indexes of the HQPACK with the NQPACK (the corner that has a straight-line notch cut out of it) and insert the HQPACK into the NQPACK (see “Figure 5”).  
The HQPACK pins are thin and easily bent. When you are connecting the HQPACK to the NQPACK, ensure that the HQPACK pins are not bent before pushing it all the way into the NQPACK.
3. Insert the screws for securing the HQPACK into the four holes in the HQPACK, and then tighten the screws in the opposite corners evenly using the special screw driver that was included with the NQPACK. Be careful not to over-tighten the screws as this may result in bad connections.

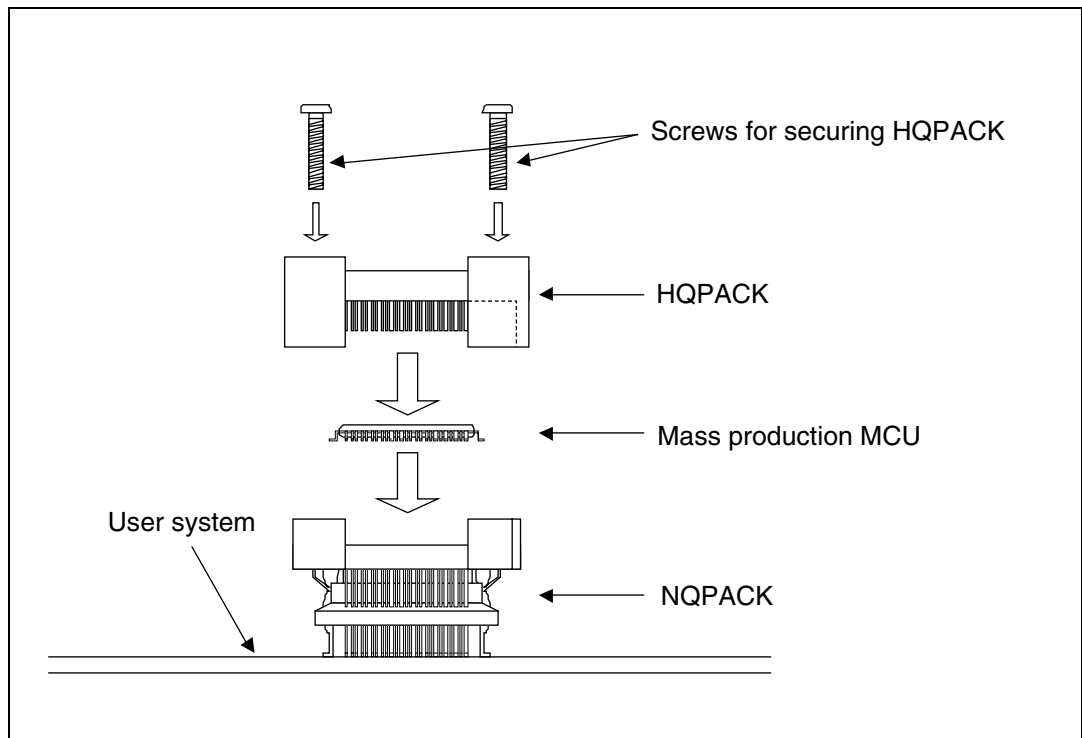

Figure 5 Mounting a mass production MCU

### ■ Disconnection

To remove the HQPACK, remove all four screws, and pull out the HQPACK vertically.

## 7. Connector Pin Assignment

Tables 1 and 2 list the pin connections for the mass production MCU, the adapter I/F connectors, and the evaluation MCU on the adapter board.

For detailed pin information for the mass production MCUs, refer to the data sheets or hardware manuals.

The following notes are related to the tables.

 : VCC

The power supply (VCC) pin numbers on the evaluation MCU are as follows.

VCC = A18, C3, D8, D12, E1, K1, K17, R1, R3, R6, T8, U2, U5, V6, V14, V18

The power supply (VCC) pin numbers on the mass production MCU are as follows.

VCC = 1, 18, 35, 37, 44, 60, 81, 126

 : VSS

The ground (VSS) pin numbers on the evaluation MCU are as follows.

VSS = B8, B12, C16, D1, D4, K4, K15, N2, R8, T3, T6, T12, T16, V1, V3, V7

The ground (VSS) pin numbers on the mass production MCU are as follows.

VSS = 19, 36, 45, 55, 59, 80, 125, 144

“ - ” : Unconnected (open circuit) pins

\*1 : Unconnected pin : Fixed to VCC on the header board.

\*2 : Unconnected pin : Fixed to VSS on the header board.

Table 1 Pin Assignment of Adapter I/F Connector 1

Connector pin number	Evaluation MCU pin number	Mass produced MCU pin number	Connector pin number	Evaluation MCU pin number	Mass produced MCU pin number
1	-	-	61	H4	20
2	C10	134	62	H3	21
3	A10	133	63	H2	22
4	A9	132	64	H1	23
5	D9	131	65	J2	24
6	C9	130	66	J4	25
7	B9	129	67	J3	26
8	A8	128	68	J1	27
9	A7	127	69	VCC	-
10	VSS	-	70	VSS	-
11	VCC	-	71	K3	28
12	C8	58	72	K2	29
13	VSS	-	73	L1	*2
14	A6	124	74	M1	*2
15	B7	123	75	L4	*2
16	D7	122	76	L3	*2
17	C7	121	77	L2	*2
18	A5	120	78	N1	*2
19	B6	119	79	VSS	-
20	A4	118	80	M2	50
21	D6	117	81	M4	51
22	VSS	-	82	M3	52
23	VCC	-	83	VSS	-
24	C6	116	84	VSS	-
25	B5	115	85	P1	34
26	A3	114	86	VSS	-
27	B4	113	87	VSS	-
28	D5	112	88	VCC	-
29	C5	111	89	VCC	-
30	A2	110	90	VSS	-
31	B3	109	91	VCC	-
32	VSS	-	92	VSS	-
33	VSS	-	93	T4	38
34	C4	54	94	U3	39
35	A1	53	95	V2	40
36	VSS	-	96	T5	41
37	VSS	-	97	R5	42
38	B2	97	98	U4	43
39	D3	98	99	VCC	-
40	C2	99	100	VSS	-
41	B1	100	101	VSS	-
42	E3	101	102	VCC	-
43	E4	102	103	U6	*2
44	VCC	-	104	V4	*2
45	VCC	-	105	V5	*2
46	D2	103	106	T7	*2
47	E2	104	107	R7	*2
48	C1	105	108	U7	*2
49	F3	106	109	VCC	-
50	F4	107	110	VSS	-
51	F2	108	111	VSS	-
52	VSS	-	112	VCC	-
53	VCC	-	113	U8	46
54	G3	61	114	V8	47
55	G4	62	115	U9	48
56	G2	63	116	R9	49
57	F1	64	117	T9	56
58	VSS	-	118	V9	57
59	G1	30	119	VSS	-
60	VSS	-	120	-	-

Table 2 Pin Assignment of Adapter I/F Connector 2

Connector pin number	Evaluation MCU pin number	Mass produced MCU pin number	Connector pin number	Evaluation MCU pin number	Mass produced MCU pin number
1	D10	135	61	H18	92
2	B10	136	62	J17	93
3	A11	137	63	J16	*2
4	B11	138	64	J15	*2
5	C11	139	65	J18	*2
6	D11	140	66	K18	*2
7	A12	141	67	K16	95
8	A13	142	68	VCC	-
9	VSS	-	69	VSS	-
10	VCC	-	70	L16	68
11	C12	9	71	L15	69
12	VSS	-	72	M18	70
13	VSS	-	73	N18	71
14	B15	8	74	R18	76
15	C13	143	75	N17	77
16	VSS	-	76	N15	78
17	VSS	-	77	N16	79
18	A16	2	78	VSS	-
19	B14	3	79	M17	74
20	VSS	-	80	M15	73
21	VSS	-	81	M16	72
22	D13	4	82	P18	75
23	B13	5	83	R17	*2
24	VSS	-	84	P15	*2
25	VSS	-	85	P16	*2
26	A14	6	86	U18	*2
27	A15	7	87	T17	*2
28	B16	*1	88	R16	*2
29	VSS	-	89	U17	*2
30	C15	*1	90	T15	*2
31	B17	65	91	VSS	-
32	L18	66	92	VCC	-
33	L17	67	93	R15	*2
34	VCC	-	94	U16	*2
35	VSS	-	95	V17	*2
36	D16	*2	96	T14	*2
37	D15	*2	97	VSS	-
38	C17	*2	98	R14	17
39	B18	*2	99	U15	16
40	E16	*2	100	V16	15
41	E15	*2	101	U14	14
42	D17	*2	102	T13	13
43	C18	*2	103	R13	12
44	VSS	-	104	V15	11
45	E17	94	105	U13	10
46	F16	*1	106	VCC	-
47	F15	96	107	VSS	-
48	D18	*1	108	R12	*2
49	VSS	-	109	U12	*2
50	F17	82	110	V13	*2
51	E18	83	111	U11	33
52	G16	84	112	T11	32
53	G15	85	113	R11	31
54	G17	86	114	VSS	-
55	F18	87	115	V12	*1
56	H17	88	116	V11	*2
57	H16	89	117	U10	*2
58	VSS	-	118	T10	*2
59	H15	90	119	R10	*2
60	G18	91	120	V10	*2

SS01-71092-1E

---

**FUJITSU MICROELECTRONICS • SUPPORT SYSTEM**

DSU-FR EMULATOR  
LQFP-144P HEADER TYPE 9  
MB2198-161-E  
OPERATION MANUAL

---

April 2008 the first edition

Published **FUJITSU MICROELECTRONICS LIMITED**

Edited Strategic Business Development Dept.

---

  
FUJITSU