

MEASURE INDOOR AND OUTDOOR TEMPERATURES WITH THIS

THERMOMETER PROJECT KIT

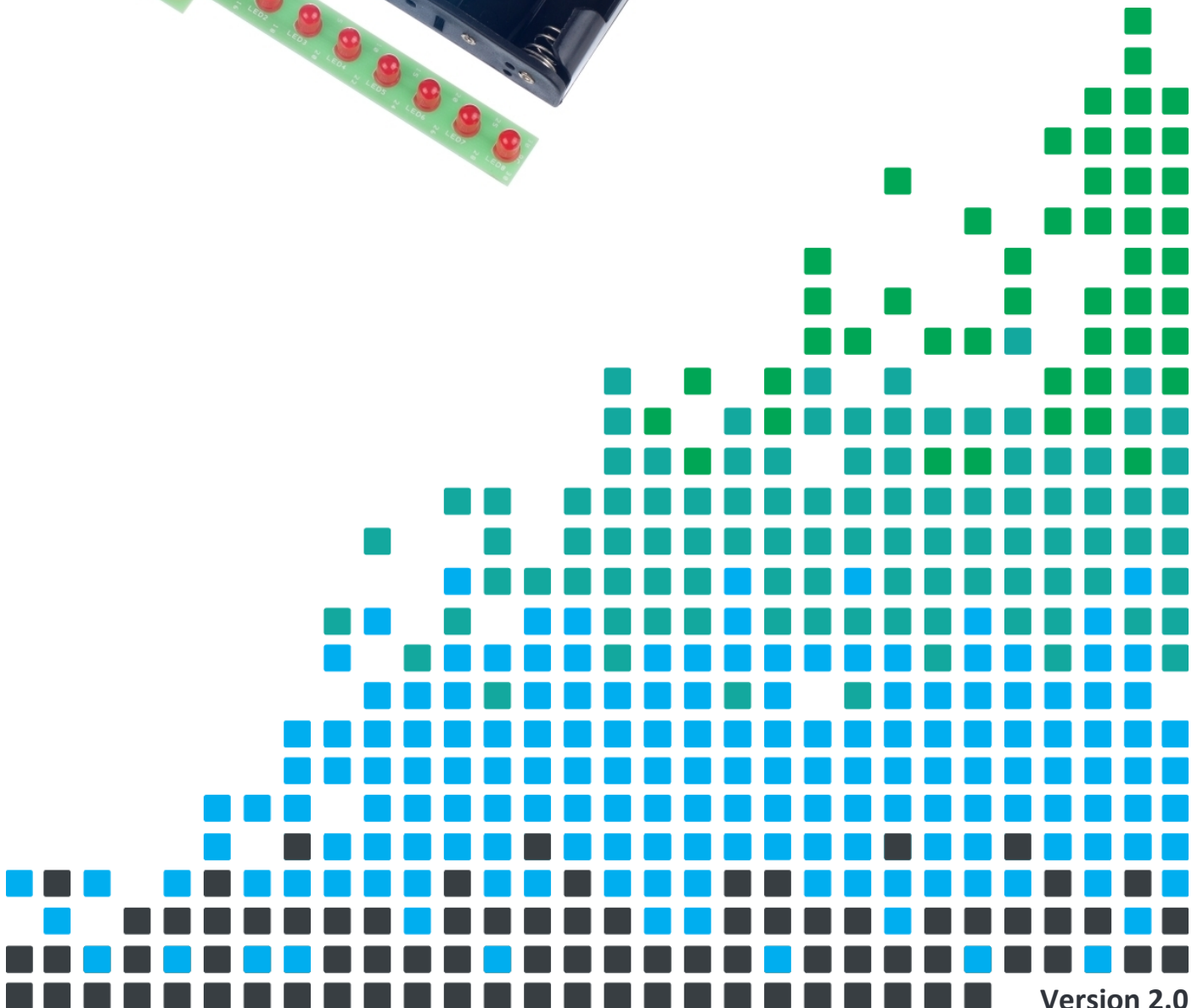
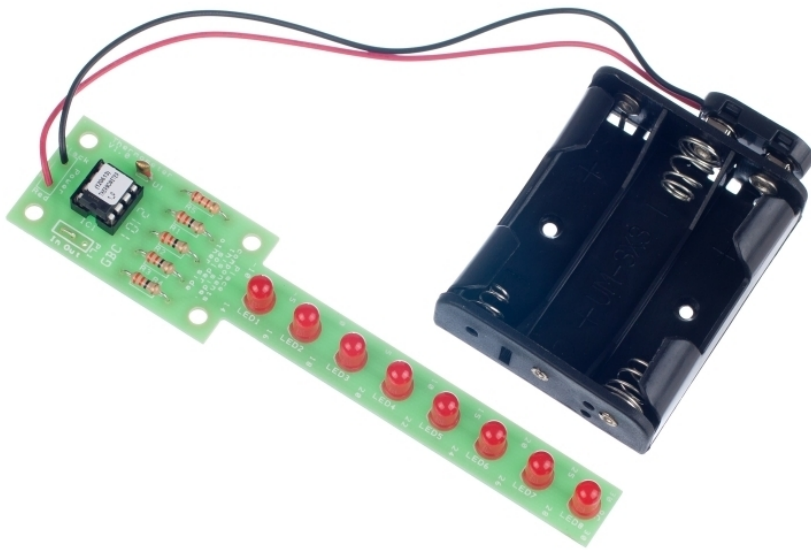

Index of Sheets

TEACHING RESOURCES

- Index of Sheets
- Introduction
- Schemes of Work
- Answers
- The Design Process
- The Design Brief
- Investigation / Research
- Developing a Specification
- Design
- Design Review (group task)
- Soldering in Ten Steps
- Resistor Values
- LEDs & Current Limit Resistors
- LEDs Continued
- Thermistors
- Evaluation
- Packaging Design

ESSENTIAL INFORMATION

- Build Instructions
- Checking Your Thermometer PCB
- Testing the PCB
- Adding an On / Off Switch
- Fault Finding
- Designing the Enclosure
- How the Thermometer Project Works
- Online Information



Introduction

About the project kit

Both the project kit and the supporting material have been carefully designed for use in KS3 Design and Technology lessons. The project kit has been designed so that even teachers with a limited knowledge of electronics should have no trouble using it as a basis from which they can form a scheme of work.

The project kits can be used in two ways:

1. As part of a larger project involving all aspects of a product design, such as designing an enclosure for the electronics to fit into.
2. On their own as a way of introducing electronics and electronic construction to students over a number of lessons.

This booklet contains a wealth of material to aid the teacher in either case.

Using the booklet

The first few pages of this booklet contains information to aid the teacher in planning their lessons and also covers worksheet answers. The rest of the booklet is designed to be printed out as classroom handouts. In most cases all of the sheets will not be needed, hence there being no page numbers, teachers can pick and choose as they see fit.

Please feel free to print any pages of this booklet to use as student handouts in conjunction with Kitronik project kits.

Support and resources

You can also find additional resources at www.kitronik.co.uk. There are component fact sheets, information on calculating resistor and capacitor values, puzzles and much more.

Kitronik provide a next day response technical assistance service via e-mail. If you have any questions regarding this kit or even suggestions for improvements, please e-mail us at:

support@kitronik.co.uk

Alternatively, phone us on 0845 8380781.



Schemes of Work

Two schemes of work are included in this pack; the first is a complete project including the design & manufacture of an enclosure for the kit (below). The second is a much shorter focused practical task covering just the assembly of the kit (next page). Equally, feel free to use the material as you see fit to develop your own schemes.

Before starting we would advise that you to build a kit yourself. This will allow you to become familiar with the project and will provide a unit to demonstrate.

Complete product design project including electronics and enclosure

Hour 1	Introduce the task using 'The Design Brief' sheet. Demonstrate a built unit. Take students through the design process using 'The Design Process' sheet. <u>Homework</u> : Collect examples of electronic products and thermometers. List the common features of these products on the 'Investigation / Research' sheet.
Hour 2	Develop a specification for the project using the 'Developing a Specification' sheet. <u>Resource</u> : Sample of products that are similar to thermometers. <u>Homework</u> : Using the internet or other search method, find out what is meant by 'design for manufacture'. List five reasons why design for manufacture should be considered on any design project.
Hour 3	Read 'Designing the Enclosure' sheet. Develop a product design using the 'Design' sheet. <u>Homework</u> : Complete design.
Hour 4	Using cardboard, get the students to model their enclosure design. Allow them to make alterations to their design if the model shows any areas that need changing.
Hour 5	Split the students into groups and get them to perform a group design review using the 'Design Review' sheet.
Hour 6	Using the 'Soldering in Ten Steps' sheet, demonstrate and get students to practice soldering. Start the 'Resistor Value' worksheet. <u>Homework</u> : Complete any of the remaining resistor tasks.
Hour 7	Build the electronic kit using the 'Build Instructions'. <u>Homework</u> : Read the 'Thermistors' sheet.
Hour 8	Complete the build of the electronic kit. Check the completed PCB and fault find if required using the 'Checking Your Thermometer PCB' section and the fault finding flow chart. <u>Homework</u> : Read 'How the Thermometer Project Works' sheet.
Hour 9	Build the enclosure.
Hour 10	Build the enclosure.
Hour 11	Build the enclosure.
Hour 12	Using the 'Evaluation' and 'Improvement' sheet, get the students to evaluate their final product and state where improvements can be made.

Additional Work

Package design for those who complete ahead of others.



Electronics only

Hour 1	Introduction to the kit demonstrating a built unit. Using the 'Soldering in Ten Steps' sheet, practice soldering.
Hour 2	Build the kit using the 'Build Instructions'.
Hour 3	Check the completed PCB and fault find if required using 'Checking Your Thermometer PCB' and fault finding flow chart.

Answers

Resistor questions

1st Band	2nd Band	Multiplier x	Value
Brown	Black	Yellow	100,000 Ω
Green	Blue	Brown	560 Ω
Brown	Grey	Yellow	180,000 Ω
Orange	White	Black	39 Ω

Value	1st Band	2nd Band	Multiplier x
180 Ω	Brown	Grey	Brown
3,900 Ω	Orange	White	Red
47,000 (47K) Ω	Yellow	Violet	Orange
1,000,000 (1M) Ω	Brown	Black	Green



The Design Process

The design process can be short or long, but will always consist of a number of steps that are the same on every project. By splitting a project into these clearly defined steps, it becomes more structured and manageable. The steps allow clear focus on a specific task before moving to the next phase of the project. A typical design process is shown on the right.

Design brief

What is the purpose or aim of the project? Why is it required and who is it for?

Investigation

Research the background of the project. What might the requirements be? Are there competitors and what are they doing? The more information found out about the problem at this stage, the better, as it may make a big difference later in the project.

Specification

This is a complete list of all the requirements that the project must fulfil - no matter how small. This will allow you to focus on specifics at the design stage and to evaluate your design. Missing a key point from a specification can result in a product that does not fulfil its required task.

Design

Develop your ideas and produce a design that meets the requirements listed in the specification. At this stage it is often normal to prototype some of your ideas to see which work and which do not.

Build

Build your design based upon the design that you have developed.

Evaluate

Does the product meet all points listed in the specification? If not, return to the design stage and make the required changes. Does it then meet all of the requirements of the design brief? If not, return to the specification stage and make improvements to the specification that will allow the product to meet these requirements and repeat from this point. It is normal to have such iterations in design projects, though you normally aim to keep these to a minimum.

Improve

Do you feel the product could be improved in any way? These improvements can be added to the design.

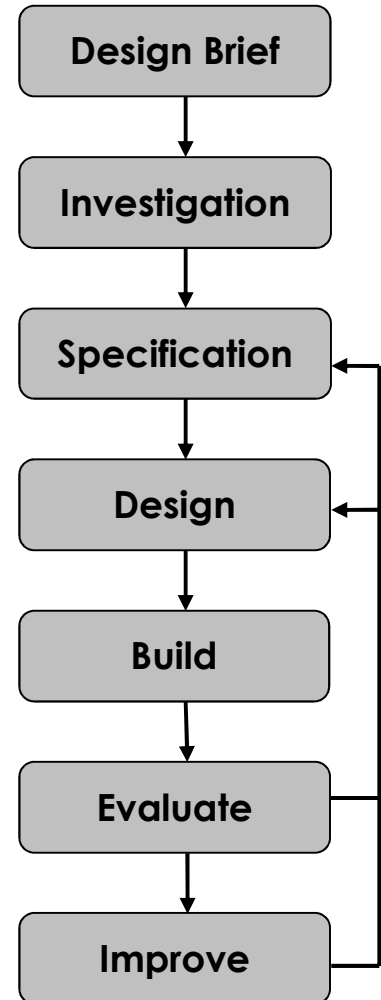

The Design Brief

A company that manufactures conventional mercury thermometers has worked with an electronics manufacturer to produce a new electronic thermometer. The thermometer has been developed to the point where they have a working prototype Printed Circuit Board (PCB).

The manufacturer is unsure how the final product should look and feel as they do not normally make this type of product. They have asked you to develop an enclosure for the thermometer.

The board has been designed to allow both an indoor and outdoor thermometer to be made with the temperature range being selected by a wire link at the time of manufacture. The PCB is marked next to the LEDs with the temperature each LED corresponds to. You may wish to include this scale on the outside of your enclosure so the user can read it.

You should decide whether you are making an indoor or outdoor thermometer – just remember that if you are making an outdoor thermometer, you will need to keep the rain off the electronics.

Complete Circuit

A fully built circuit is shown below.

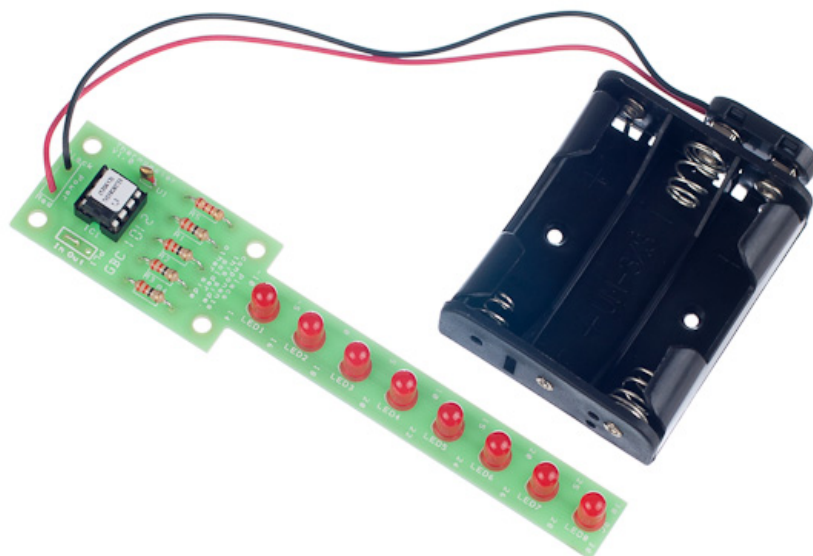

Investigation / Research

Using a number of different search methods, find examples of similar products that are already on the market. Use additional pages if required.

Name.....

Class.....



Developing a Specification

Using your research into the target market for the product, identify the key requirements for the product and explain why each of these is important.

Name.....

Class.....

Requirement	Reason
Example: It should have a weather proof enclosure.	Example: So that it can be used outside without the electronic components getting damaged.



Design

Develop your ideas to produce a design that meets the requirements listed in the specification.

Name.....

Class.....



Design Review (group task)

Split into groups of three or four. Take it in turns to review each person's design against the requirements of their specification. Also look to see if you can spot any additional aspects of each design that may cause problems with the final product. This will allow you to ensure that you have a good design and catch any faults early in the design process. Note each point that is made and the reason behind it. Decide if you are going to accept or reject the comment made. Use these points to make improvements to your initial design.

Comment	Reason for comment	Accept or Reject



Soldering in Ten Steps

1. Start with the smallest components working up to the taller components, soldering any interconnecting wires last.
2. Place the component into the board, making sure that it goes in the right way around and the part sits flush against the board.
3. Bend the leads slightly to secure the part.
4. Make sure that the soldering iron has warmed up and if necessary, use the damp sponge to clean the tip.
5. Place the soldering iron on the pad.
6. Using your free hand, feed the end of the solder onto the pad (top picture).
7. Remove the solder, then the soldering iron.
8. Leave the joint to cool for a few seconds.
9. Using a pair of cutters, trim the excess component lead (middle picture).
10. If you make a mistake heat up the joint with the soldering iron, whilst the solder is molten, place the tip of your solder extractor by the solder and push the button (bottom picture).

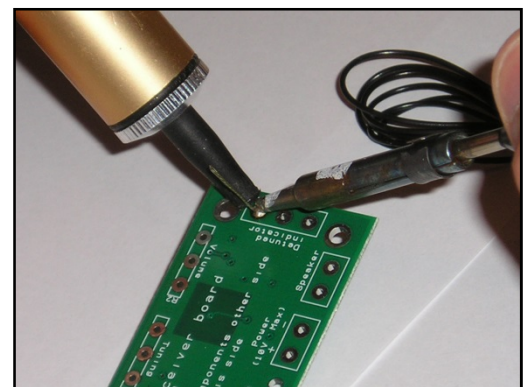
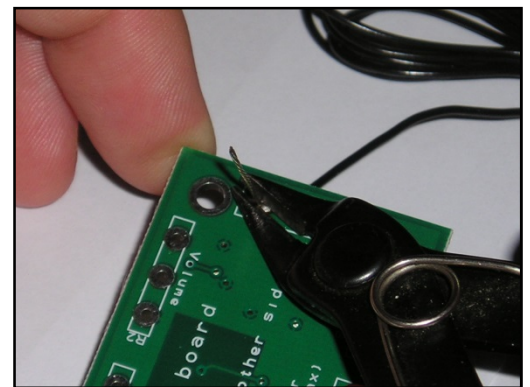
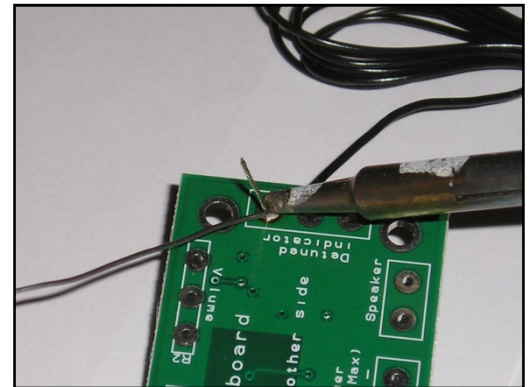

Solder joints

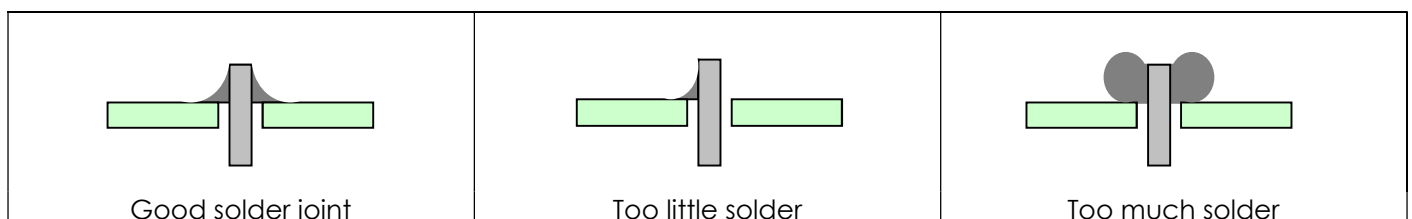

Resistor Values

A resistor is a device that opposes the flow of electrical current. The bigger the value of a resistor, the more it opposes the current flow. The value of a resistor is given in Ω (ohms) and is often referred to as its 'resistance'.

Identifying resistor values

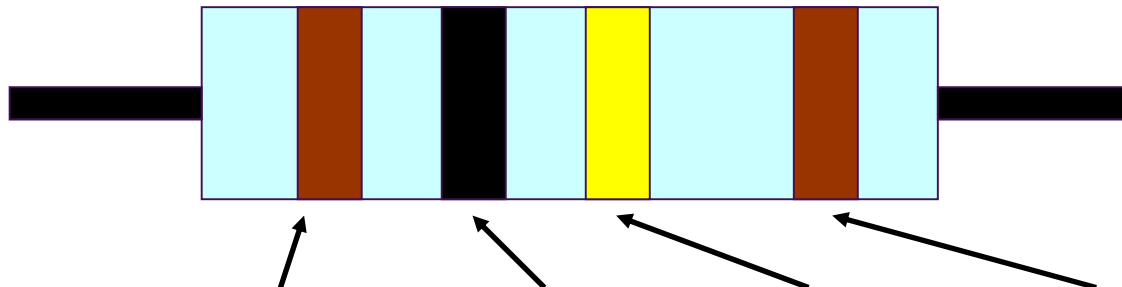

Band Colour	1st Band	2nd Band	Multiplier x	Tolerance
Silver			$\div 100$	10%
Gold			$\div 10$	5%
Black	0	0	1	
Brown	1	1	10	1%
Red	2	2	100	2%
Orange	3	3	1000	
Yellow	4	4	10,000	
Green	5	5	100,000	
Blue	6	6	1,000,000	
Violet	7	7		
Grey	8	8		
White	9	9		

Example: Band 1 = Red, Band 2 = Violet, Band 3 = Orange, Band 4 = Gold

The value of this resistor would be:

$$\begin{aligned}
 &2 \text{ (Red)} \ 7 \text{ (Violet)} \times 1,000 \text{ (Orange)} &&= 27 \times 1,000 \\
 &&&= 27,000 \text{ with a 5% tolerance (gold)} \\
 &&&= 27\text{K}\Omega
 \end{aligned}$$

Too many zeros?

Kilo ohms and mega ohms can be used:

$$1,000\Omega = 1\text{K}$$

$$1,000\text{K} = 1\text{M}$$

Resistor identification task

Calculate the resistor values given by the bands shown below. The tolerance band has been ignored.

1st Band	2nd Band	Multiplier x	Value
Brown	Black	Yellow	
Green	Blue	Brown	
Brown	Grey	Yellow	
Orange	White	Black	



Calculating resistor markings

Calculate what the colour bands would be for the following resistor values.

Value	1st Band	2nd Band	Multiplier x
180 Ω			
3,900 Ω			
47,000 (47K) Ω			
1,000,000 (1M) Ω			

What does tolerance mean?

Resistors always have a tolerance but what does this mean? It refers to the accuracy to which it has been manufactured. For example if you were to measure the resistance of a gold tolerance resistor you can guarantee that the value measured will be within 5% of its stated value. Tolerances are important if the accuracy of a resistors value is critical to a design's performance.

Preferred values

There are a number of different ranges of values for resistors. Two of the most popular are the E12 and E24. They take into account the manufacturing tolerance and are chosen such that there is a minimum overlap between the upper possible value of the first value in the series and the lowest possible value of the next. Hence there are fewer values in the 10% tolerance range.

E-12 resistance tolerance ($\pm 10\%$)											
10	12	15	18	22	27	33	39	47	56	68	82

E-24 resistance tolerance ($\pm 5\%$)											
10	11	12	13	15	16	18	20	22	24	27	30
33	36	39	43	47	51	56	62	68	75	82	91



LEDs & Current Limit Resistors

Before we look at LEDs, we first need to start with diodes. Diodes are used to control the direction of flow of electricity. In one direction they allow the current to flow through the diode, in the other direction the current is blocked.

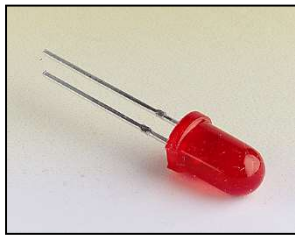

An LED is a special diode. LED stands for Light Emitting Diode. LEDs are like normal diodes, in that they only allow current to flow in one direction, however when the current is flowing the LED lights.

The symbol for an LED is the same as the diode but with the addition of two arrows to show that there is light coming from the diode. As the LED only allows current to flow in one direction, it's important that we can work out which way the electricity will flow. This is indicated by a flat edge on the LED.

For an LED to light properly, the amount of current that flows through it needs to be controlled. To do this we use a current limit resistor. If we didn't use a current limit resistor the LED would be very bright for a short amount of time, before being permanently destroyed.

To work out the best resistor value we need to use Ohms Law. This connects the voltage across a device and the current flowing through it to its resistance.

Ohms Law tells us that the flow of current (I) in a circuit is given by the voltage (V) across the circuit divided by the resistance (R) of the circuit.

$$I = \frac{V}{R}$$

Like diodes, LEDs drop some voltage across them: typically 1.8 volts for a standard LED. However the high brightness LED used in the 'white light' version of the lamp drops 3.5 volts.

The USB lamp runs off the 5V supply provided by the USB connection so there must be a total of 5 volts dropped across the LED (V_{LED}) and the resistor (V_R). As the LED manufacturer's datasheet tells us that there is 3.5 volts dropped across the LED, there must be 1.5 volts dropped across the resistor. ($V_{LED} + V_R = 3.5 + 1.5 = 5V$).

LEDs normally need about 10mA to operate at a good brightness. Since we know that the voltage across the current limit resistor is 1.5 volts and we know that the current flowing through it is 0.01 Amps, the resistor can be calculated.

Using Ohms Law in a slightly rearranged format:

$$R = \frac{V}{I} = \frac{1.5}{0.01} = 150\Omega$$

Hence we need a 150 Ω current limit resistor.

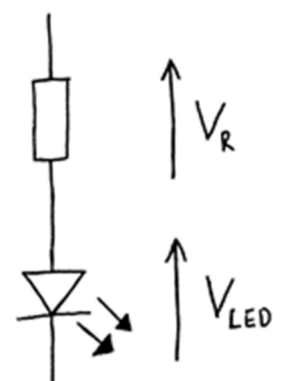

LEDs Continued

The Colour Changing LEDs used in the 'colour' version of the lamp has the current limit resistor built into the LED itself. Therefore no current limit resistor is required. Because of this, a 'zero Ω ' resistor is used to connect the voltage supply of 5V directly to the Colour Changing LED.

Packages

LEDs are available in many shapes and sizes. The 5mm round LED is the most common. The colour of the plastic lens is often the same as the actual colour of light emitted – but not always with high brightness LEDs.

Advantages of using LEDs over bulbs

Some of the advantages of using an LED over a traditional bulb are:

Power efficiency	LEDs use less power to produce the same amount of light, which means that they are more efficient. This makes them ideal for battery power applications.
Long life	LEDs have a very long life when compared to normal light bulbs. They also fail by gradually dimming over time instead of a sharp burn out.
Low temperature	Due to the higher efficiency of LEDs, they can run much cooler than a bulb.
Hard to break	LEDs are much more resistant to mechanical shock, making them more difficult to break than a bulb.
Small	LEDs can be made very small. This allows them to be used in many applications, which would not be possible with a bulb.
Fast turn on	LEDs can light up faster than normal light bulbs, making them ideal for use in car break lights.

Disadvantages of using LEDs

Some of the disadvantages of using an LED over a traditional bulb are:

Cost	LEDs currently cost more for the same light output than traditional bulbs. However, this needs to be balanced against the lower running cost of LEDs due to their greater efficiency.
Drive circuit	To work in the desired manner, an LED must be supplied with the correct current. This could take the form of a series resistor or a regulated power supply.
Directional	LEDs normally produce a light that is focused in one direction, which is not ideal for some applications.

Typical LED applications

Some applications that use LEDs are:

- Bicycle lights
- Car lights (break and headlights)
- Traffic lights
- Indicator lights on consumer electronics
- Torches
- Backlights on flat screen TVs and displays
- Road signs
- Information displays
- Household lights
- Clocks



Thermistors

A thermistor is a component that has a resistance that changes with temperature. There are two types of thermistors: those with a resistance that increase with temperature (Positive Temperature Coefficient – PTC), and those with a resistance that falls with temperature (Negative Temperature Coefficient – NTC).

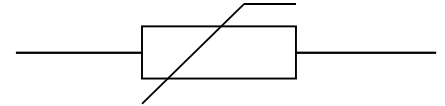

Temperature coefficient

Most have a resistance falls as the temperatures increases (NTC).

The amount by which the resistance decreases as the temperature decreases isn't constant. It varies with temperature. A formula can be used to calculate the resistance of the thermistor at any given temperature. Normally these are calculated for you and the information can be found in the device's datasheet.

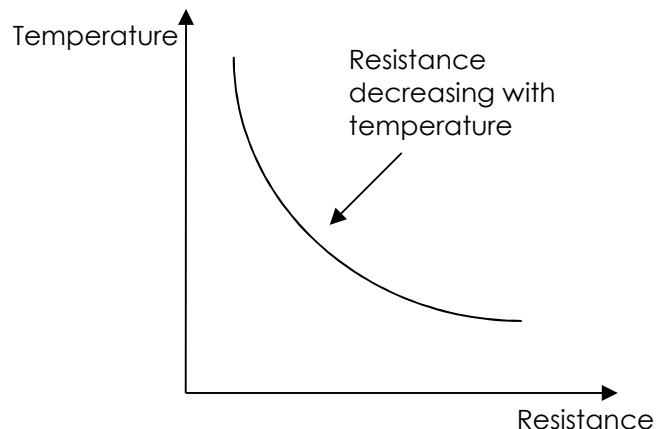

Applications

There are many applications for a thermistor. Three of the most popular are listed below.

Temperature sensing

The most obvious application for a thermistor is to measure temperature. They are used to do this in a wide range of products such as thermostats.

In rush current limiting

In this application the thermistor is used to initially oppose the flow of current (by having a high resistance) into a circuit. Then as the thermistor warms up (due to the flow of electricity through the device), the resistance drops letting current flow more easily.

Circuit protection

In this application the thermistor is used to protect a circuit by limiting the amount of current that can flow into it. If too much current starts to flow into a circuit through the thermistor, this causes the thermistor to warm up. This, in turn, increases the resistance of the thermistor, reducing the current that can flow into the circuit.



Evaluation

It is always important to evaluate your design once it is complete. This will ensure that it has met all of the requirements defined in the specification. In turn, this should ensure that the design fulfils the design brief.

Check that your design meets all of the points listed in your specification.

Show your product to another person (in real life this person should be the kind of person at which the product is aimed). Get them to identify aspects of the design, which parts they like and aspects that they feel could be improved.

Good aspects of the design	Areas that could be improved

Improvements

Every product on the market is constantly subject to redesign and improvement. What aspects of your design do you feel you could improve? List the aspects that could be improved and where possible, draw a sketch showing the changes that you would make.



Packaging Design

If your product was to be sold in a high street electrical retailer, what requirements would the packaging have? List these giving the reason for the requirement.

Requirement	Reason

Develop a packaging design for your product that meets these requirements. Use additional pages if required.





ESSENTIAL INFORMATION

BUILD INSTRUCTIONS
CHECKING YOUR PCB & FAULT-FINDING
MECHANICAL DETAILS
HOW THE KIT WORKS

MEASURE INDOOR AND OUTDOOR TEMPERATURES WITH THIS

THERMOMETER PROJECT KIT

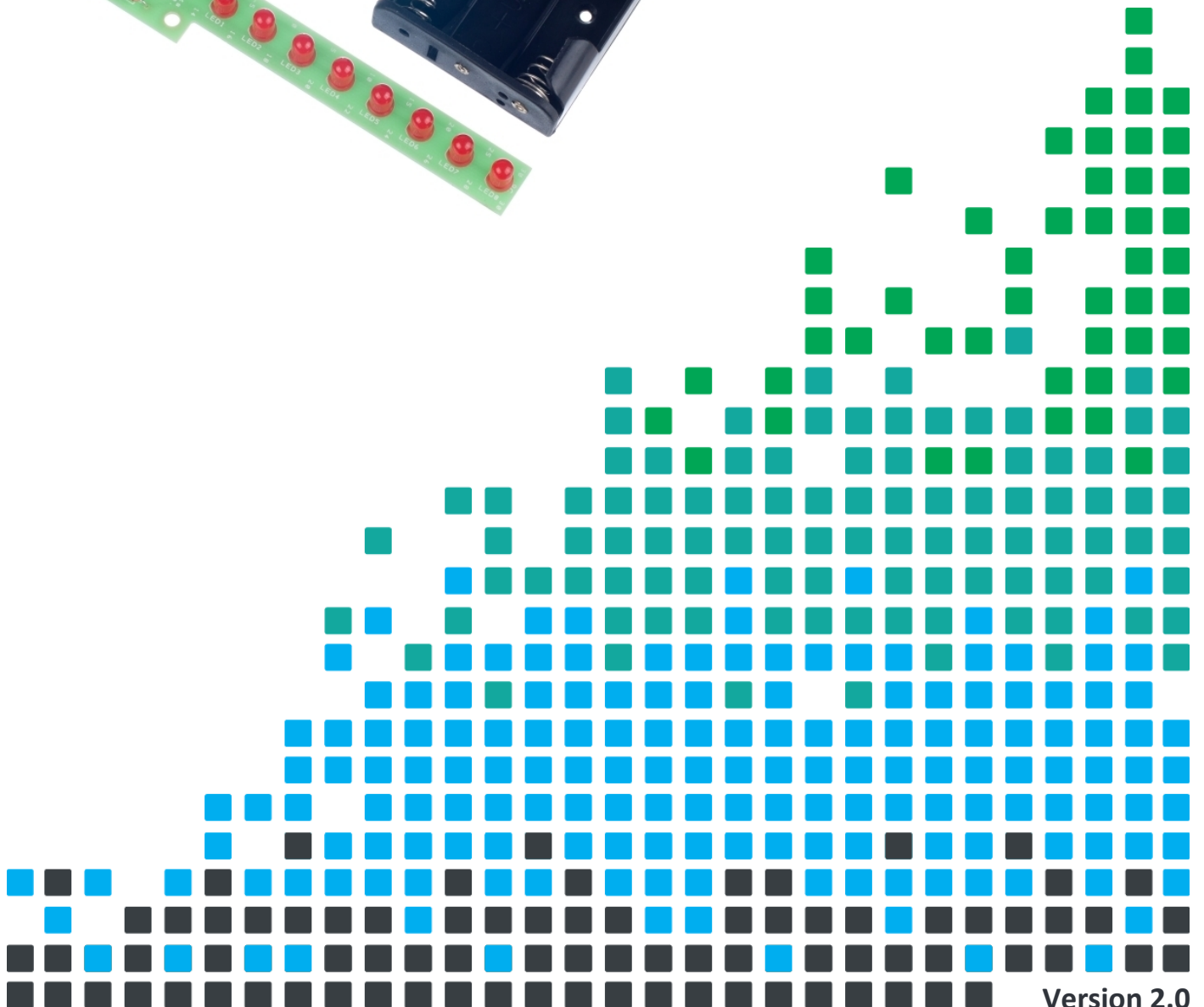
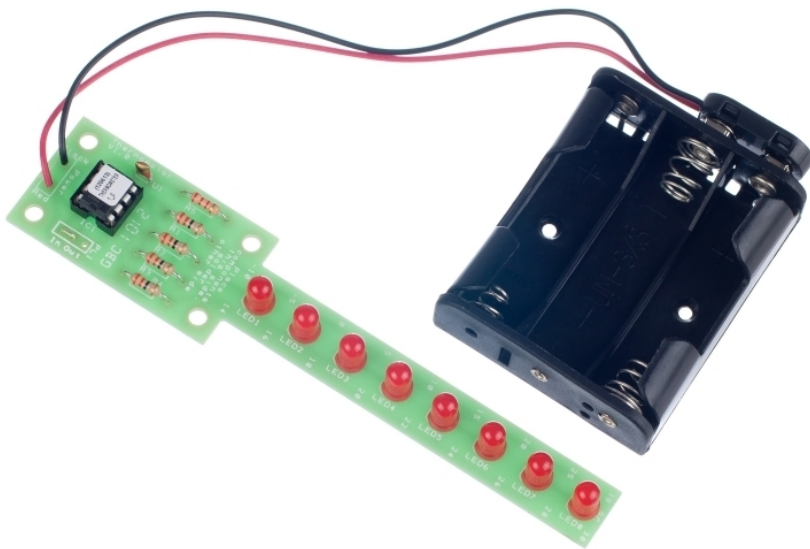

Version 2.0

Build Instructions

Before you start, take a look at the Printed Circuit Board (PCB). The components go in the side with the writing on and the solder goes on the side with the tracks and silver pads.

1 PLACE RESISTORS

Start with the five resistors:
The text on the PCB shows where R1, R2 etc go.
Ensure that you put the resistors in the right place.



PCB Ref	Value	Colour Bands
R1, R2, R3 & R4	33Ω	Orange, orange, black
R5	2.2KΩ	Red, red, red

2 SOLDER THE THERMISTOR

Solder the thermistor into U1. It does not matter which way around it is inserted.



3 SOLDER THE IC HOLDER

Solder the Integrated Circuit (IC) holder into IC1. When putting this into the board, be sure to get it the right way around. The notch on the IC holder should line up with the notch on the lines marked on the PCB.



4 SOLDER THE LEDs

Solder the eight Light Emitting Diodes (LEDs) into LED1 – LED8. The LEDs won't work if they don't go in the right way around. If you look carefully one side of the LED has a flat edge, which must line up with the flat edge on the lines on the PCB.



5 CONNECT THE WIRES

The thermometer has two temperature scales. One is designed for outdoor use, measuring from -10°C to 30°C. The other is designed for indoor use, measuring from 14°C to 30°C. To select the desired range a wire link (a discarded resistor lead etc.) should be soldered across either the pins labelled 'In' for indoor, or 'Out' for outdoor.

6 ATTACH THE BATTERY CLIP

The battery connector should be soldered into the 'Power' terminal. The red wire must go to the '+' terminal and the black wire must go to the '-' terminal.



7 INSERT THE IC INTO THE HOLDER

The IC can be put into the holder, ensuring that the notch on the chip lines up with the notch on the holder.



Checking Your Thermometer PCB

Check the following before you insert the batteries:

Check the bottom of the board to ensure that:

- All holes (except the 4 large 3mm holes) are filled with the lead of a component.
- All these leads are soldered.
- Pins next to each other are not soldered together.

Check the top of the board to ensure that:

- The notch on the IC holder / IC is next to the indoor / outdoor selector.
- The flat edge of each of the LEDs matches the outline on the board.
- The colour bands on R5 are red, red, red.
- The power lead is connected the right way around (red to '+', black to '-').

Testing the PCB

The software on the microcontroller has been specially designed to allow easy testing of the PCB.

On power up, the LEDs flash in turn LED1, LED2, through to LED8 for one second each. It then displays the temperature and continues to do this every ten seconds thereafter. Thirty seconds after power up, a bit of the non-volatile memory is used to log the successful running of the test routine and on subsequent power ups this is not run.

If your board does not function correctly when tested disconnect the power within 30 seconds of power up, otherwise you will not have the benefit of the test functionality on subsequent power ups.

If the LEDs do not light in turn, or the temperature is incorrectly displayed, use the fault finding flow charts to work out why.



Adding an On / Off Switch

You can add either a normally closed or a normally open push button switch, which works as follows:

Normally closed: When the button is pressed, it goes open circuit and removes power from the thermometer. When released it causes the software to start again and displays the temperature. In the meantime the temperature is displayed every ten seconds in any case.

Normally open: When this button is pressed the thermometer is powered and it displays the temperature. As the temperature is only shown when the button is pressed, the batteries will last considerably longer with this setup.

Toggle switch: The thermometer will show the temperature every ten seconds when switched on. Nothing is shown when switched off. *The toggle switch option is shown below.*

If you wish to add a power switch, don't solder both ends of the battery clip directly into the board, instead:

1

Solder one end of the battery clip to the PCB, either black to '-' or red to '+'.
(Note: The image shows the red wire connected to the positive terminal.)

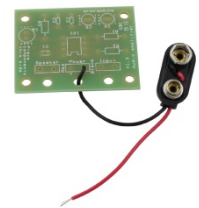

2

Solder the other end of the battery clip to the on / off switch.



3

Using a piece of wire, solder the remaining terminal on the on / off switch to the remaining power connection on the PCB.



Fault finding flow chart - page 1

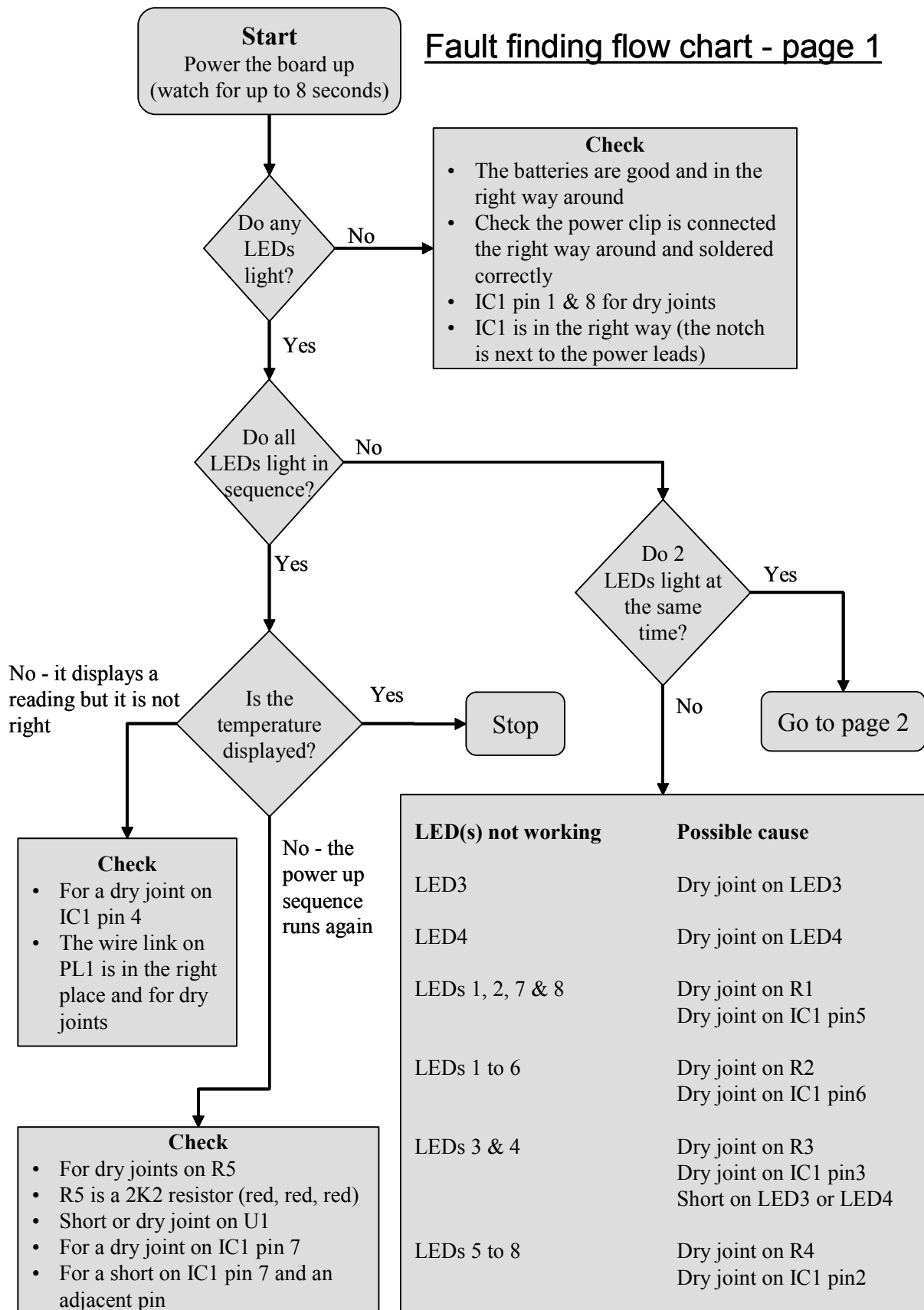

Fault finding flow chart - Page 2

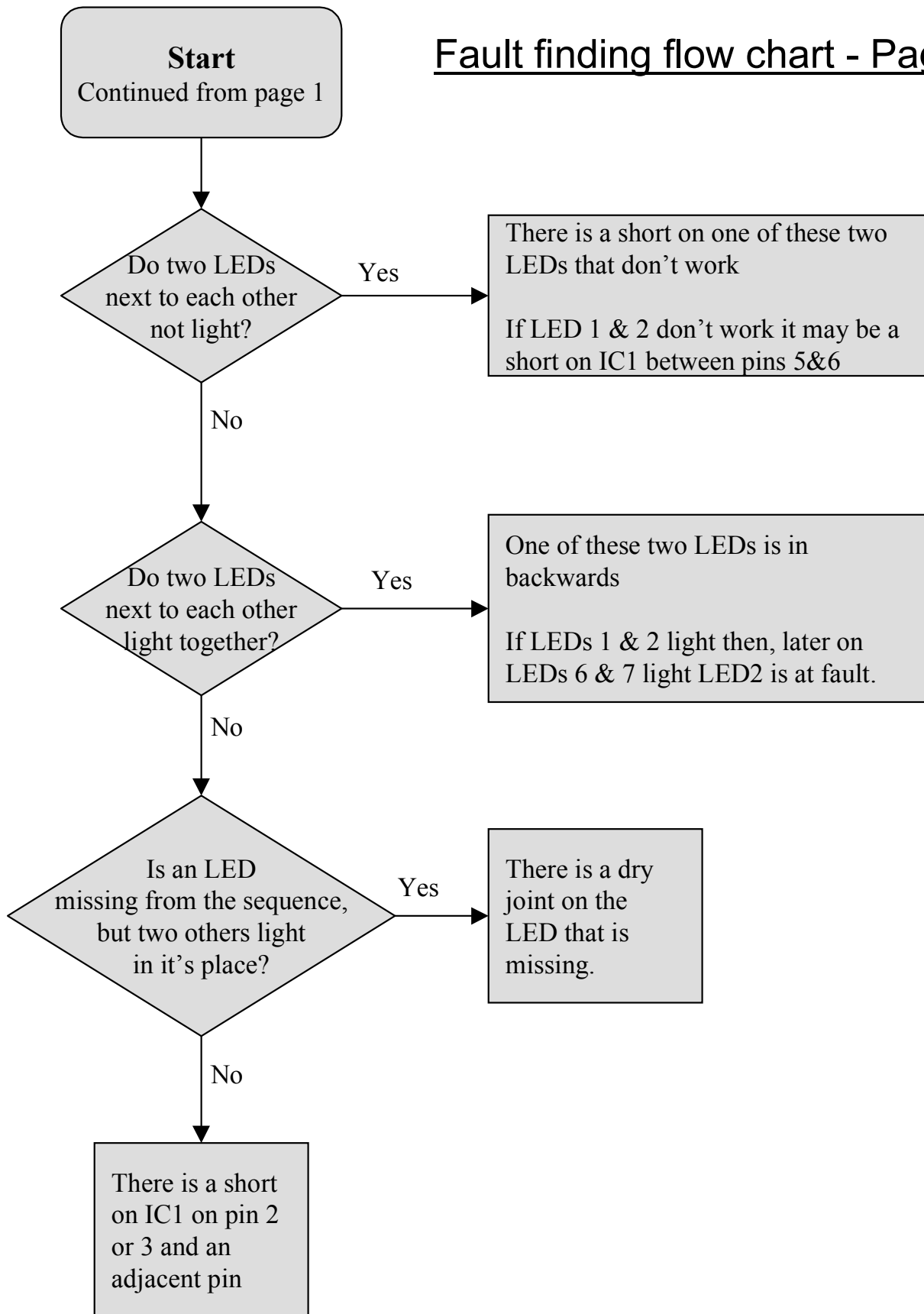

Designing the Enclosure

When you design the enclosure, you will need to consider:

- The size of the PCB (see below).
- Where the LEDs are mounted and how big they are (see below).
- The size of the battery holder (shown right).

These technical drawings of the thermometer PCB and battery cage should help you to plan this.

All dimensions are in mm.

The LEDs are 5mm in diameter and 9mm tall.

The mounting holes are 3.3mm in diameter.

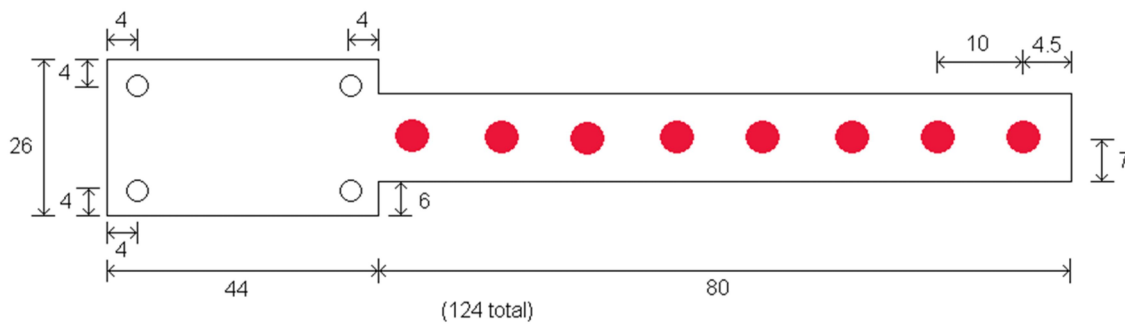
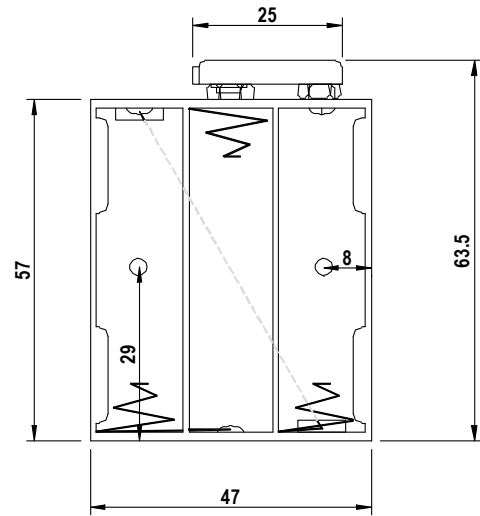

	<p>Mounting the PCB to the enclosure</p> <p>The drawing to the left shows how a hex spacer can be used with two bolts to fix the PCB to the enclosure.</p> <p><i>Your PCB has four mounting holes designed to take M3 bolts.</i></p>
--	---



How the Thermometer Project Works

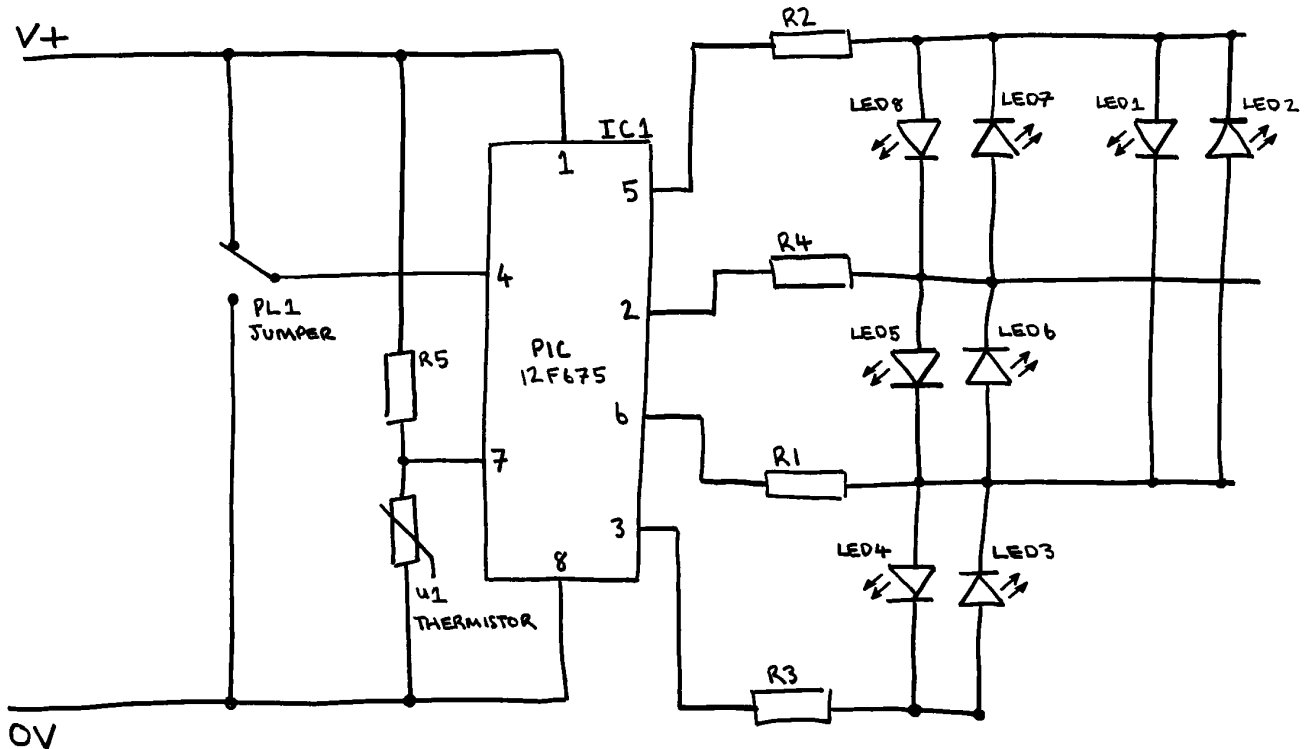

Calculating the temperature

At the heart of the electronic circuit is a microcontroller. A microcontroller is, in effect, a small computer. One of the inputs to the PIC used is capable of measuring different voltage levels that are fed into it. This is called an analogue input. It is this functionality and the variation in resistance of the thermistor with temperature that are used to calculate the temperature.

The thermistor (U1) has been connected in series with a 2.2K Ω resistor R5 to form what is called a potential divider. Either end of the potential divider is connected between V+ (the positive battery voltage) and 0V. A feed is then taken from the connecting point of R5 to U1 and fed into the PIC's analogue input (pin 7). The voltage fed to pin 7 is determined by the ratio of the resistance of the thermistor (U1) and R5. As the temperature changes and, therefore the resistance of thermistor changes, the voltage on pin 7 changes. It is this voltage level that is used by the PIC to calculate the temperature.

Displaying the temperature

Once the PIC has calculated the temperature that must be displayed, it has to light up the corresponding LEDs. The circuit uses a clever design to allow eight LEDs to be connected to only four outputs. This is known as multiplexing LEDs. Normally the output pins of the PIC are set so that no LEDs can be on (the PIC pins are set as inputs). When an LED needs to be turned on, the two pins to which it is connected are set to outputs and are driven so that there is a voltage across the LED in the correct direction. For example to turn LED1 on, pin 5 on the PIC needs to be set high and pin 6 set low. LED2 will not be on when this happens as the voltage across it is in the wrong direction for current to flow. The value of resistors R1-R4 is 33 Ω . These resistors limit the current that can flow through the LEDs. This protects the LEDs and controls their brightness.



Online Information

Two sets of information can be downloaded from the product page where the kit can also be reordered from. The 'Essential Information' contains all of the information that you need to get started with the kit and the 'Teaching Resources' contains more information on soldering, components used in the kit, educational schemes of work and so on and also includes the essentials. Download from:

www.kitronik.co.uk/2110



This kit is designed and manufactured in the UK by Kitronik

Telephone: +44 (0) 845 8380781

Sales email: sales@kitronik.co.uk

Tech support email: support@kitronik.co.uk

Web: www.kitronik.co.uk



www.kitronik.co.uk/twitter



www.kitronik.co.uk/facebook



www.kitronik.co.uk/youtube



www.kitronik.co.uk/google

Every effort has been made to ensure that these notes are correct, however Kitronik accept no responsibility for issues arising from errors / omissions in the notes.

© Kitronik Ltd - Any unauthorised copying / duplication of this booklet or part thereof for purposes except for use with Kitronik project kits is not allowed without Kitronik's prior consent.

