

1 2 3 4 5 6

A

B

C

D

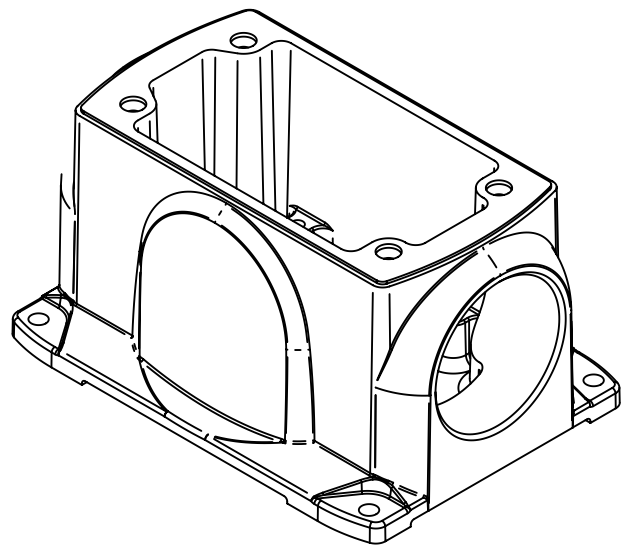
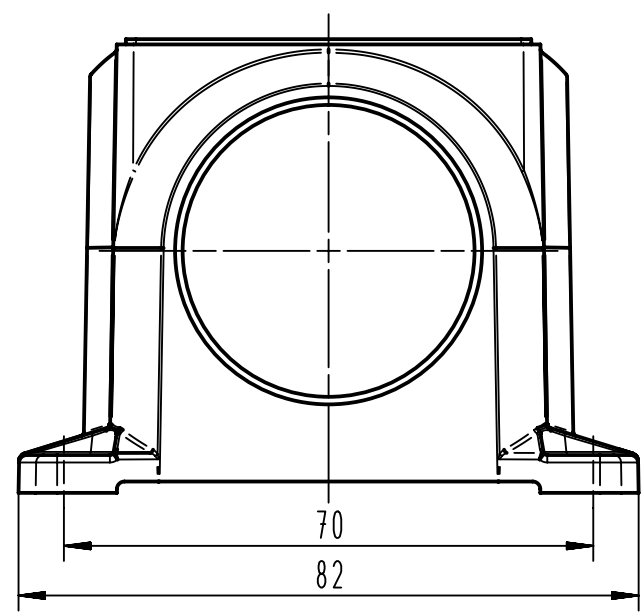
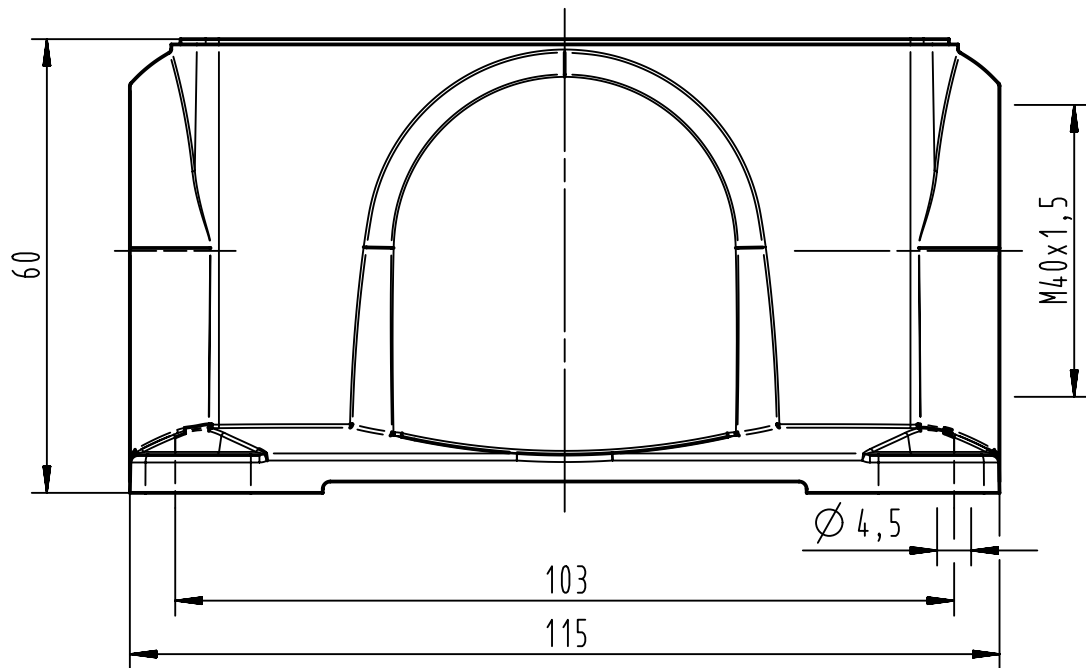

4x M4-screws and washers enclosed separately / tightening torque 1.2-2 Nm

	All Dimensions in mm Original Size DIN A4	Scale 1:1	Free size tol.			Ref.
	All rights reserved Department EL PD - DE	Created by HOLLERT	Inspected by BEISCHER	Standardisation SCHMIDTM	Date 2012-09-14	State Final Release
HARTING Electric GmbH & Co. KG D-32339 Espelkamp		Title Han-Yellock 60 HSM 1xM40			Doc-Key / ECM-Nr. 100215955/UGD/003/C	
		Type TB	Number 11 12 600 1203			Rev. C
					Page 1/1	