

GP1S36J0000F

Phototransistor Output, Transmissive Photointerrupter with Tilt Direction (3-direction) Detecting



■ Description

GP1S36J0000F is a compact-package, phototransistor output, transmissive photointerrupter, with opposing emitter and detector in a molding that provides non-contact sensing.

This is a 2-phase output device, suitable for detection of the position (3 direction).

■ Features

1. Transmissive with phototransistor output
2. Highlights :
 - Built-in a ball (2 phase output)
 - Compact
 - PWB mounting type
 - 3-direction detection
3. Lead free and RoHS directive compliant

■ Agency approvals/Compliance

1. Compliant with RoHS directive

■ Applications

1. General purpose detection of device direction.
2. Example : Camera, DSC, Camcorder, Robot

Notice The content of data sheet is subject to change without prior notice.
In the absence of confirmation by device specification sheets, SHARP takes no responsibility for any defects that may occur in equipment using any SHARP devices shown in catalogs, data books, etc. Contact SHARP in order to obtain the latest device specification sheets before using any SHARP device.

Internal Connection Diagram

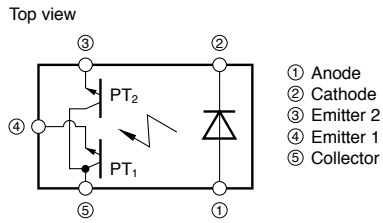

Outline Dimensions

(Unit : mm)

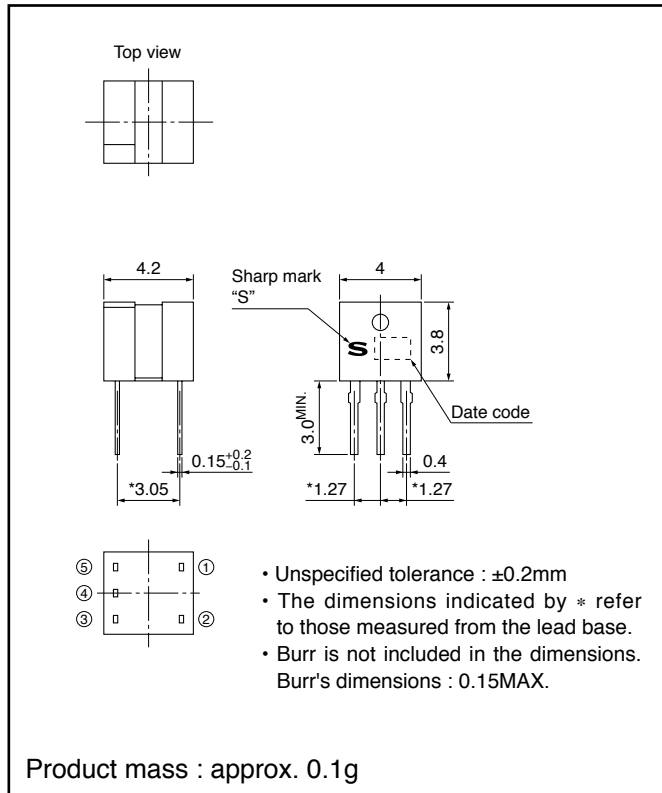

Plating material : SnCu (Cu : TYP. 2%)

Date code (2 digit)

1st digit		2nd digit	
Year of production		Month of production	
A.D.	Mark	Month	Mark
2000	0	1	1
2001	1	2	2
2002	2	3	3
2003	3	4	4
2004	4	5	5
2005	5	6	6
2006	6	7	7
2007	7	8	8
2008	8	9	9
2009	9	10	X
2010	0	11	Y
:	:	12	Z

repeats in a 10 year cycle

Country of origin

Japan, China

■ Absolute Maximum Ratings (T_a=25°C)

Parameter		Symbol	Rating	Unit
Input	Forward current	I _F	50	mA
	Reverse voltage	V _R	6	V
	Power dissipation	P	75	mW
Output	Collector-emitter voltage	V _{CE10} V _{CE20}	35	V
	Emitter-collector voltage	V _{E1CO} V _{E2CO}	6	V
	Collector current	I _C	20	mA
	Collector power dissipation	P _C	75	mW
	Total power dissipation	P _{tot}	100	mW
Operating temperature		T _{opr}	-25 to +85	°C
Storage temperature		T _{stg}	-40 to +100	°C
*1 Soldering temperature 1		T _{sol}	260	°C
*2 Soldering temperature 2		T _{sol}	320	°C

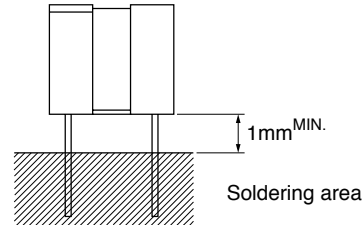

*1 For MAX. 5 s (Soldering area is shown below)

*2 For MAX. 2 s (Each terminal shall be hand-soldered at more 0.8mm for from bottom of resin package)

■ Electro-optical Characteristics (T_a=25°C)

Parameter		Symbol	Condition	MIN.	TYP.	MAX.	Unit
Input	Forward voltage	V _F	I _F =20mA	-	1.2	1.4	V
	Reverse current	I _R	V _R =3V	-	-	10	μA
*3 Output	Dark current	I _{CEO}	V _{CE} =20V	-	-	100	nA
*3 Transfer characteristics	Collector current	I _C	V _{CE} =5V, I _F =5mA	60	-	350	μA
	*4 Leak current	I _{LEAK}	V _{CE} =5V, I _F =5mA	-	-	15	μA
	Collector-emitter saturation voltage	V _{CE(sat)}	I _F =10mA, I _C =60μA	-	-	0.4	V
	Response time	Rise time	t _r	V _{CE} =5V, I _C =100μA, R _L =1kΩ	-	50	150
Fall time		t _f	-		50	150	μs

*3 Output and coupling characteristics are common to the both phototransistors.

*4 Characteristics except leak current is measured at θ=0°, φ=0°.

Leak current is the output current of transistor when θ=±90°, φ=0° and I_C=OFF.

Absolute Maximum Ratings

($I_F=5mA, V_{CC}=5V, \phi \leq \pm 5$)

θ	-90°	↔	-75°	↔	-15°	↔	+15°	↔	+75°	↔	+90°
I_{C1}	ON						Indefinite		OFF		
I_{C2}	OFF		Indefinite			ON					

I_{C1} : Output current of phototransistors PT₁

I_{C2} : Output current of phototransistors PT₂

θ : Device condition : Refer to the next figure

ϕ : Device condition : Refer to the next figure

ON : Output current of phototransistors : 60 μ A or more

OFF : Output current of phototransistors : 15 μ A or less

* Output of ON/OFF is under the condition that the device is in stationary state.

Device state diagram

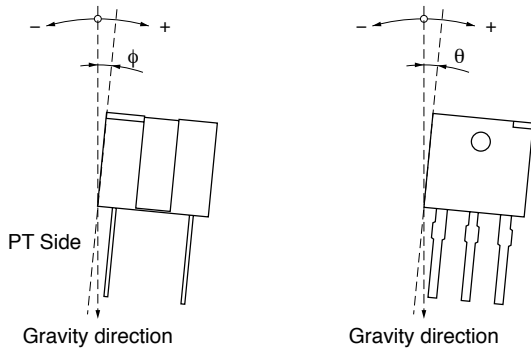

Supplement

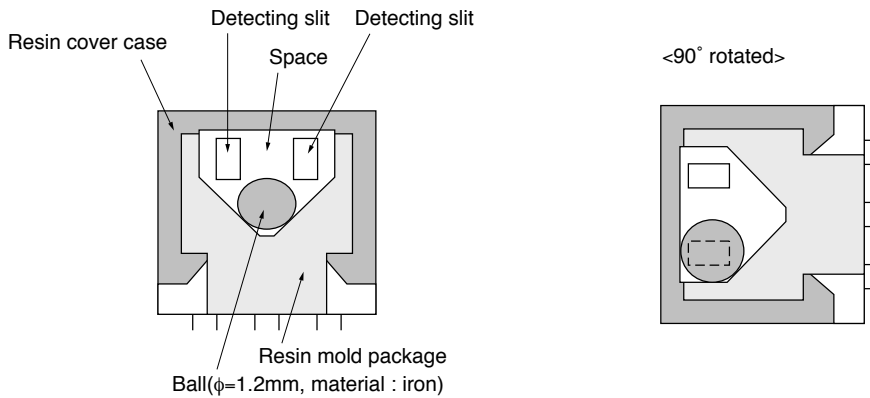

Principle of Tilt Detection (Viewing from detecting side)

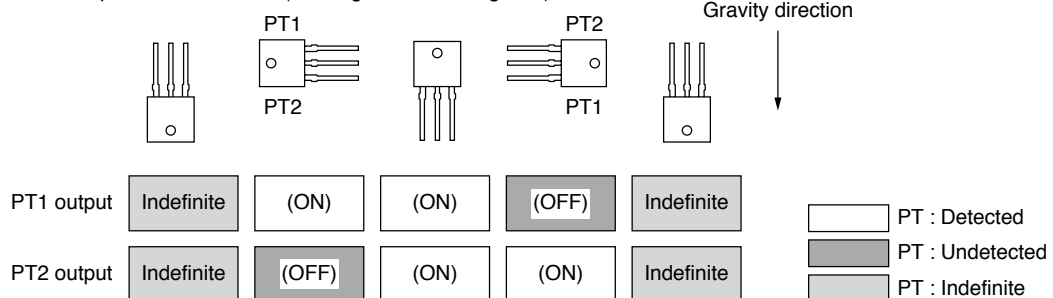

Fig.1 Forward Current vs. Ambient Temperature

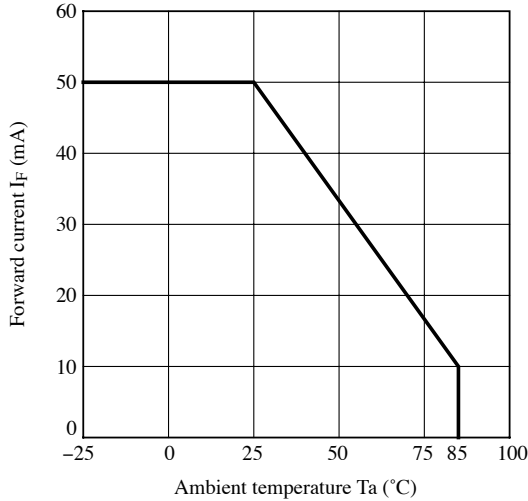

Fig.2 Power Dissipation vs. Ambient Temperature

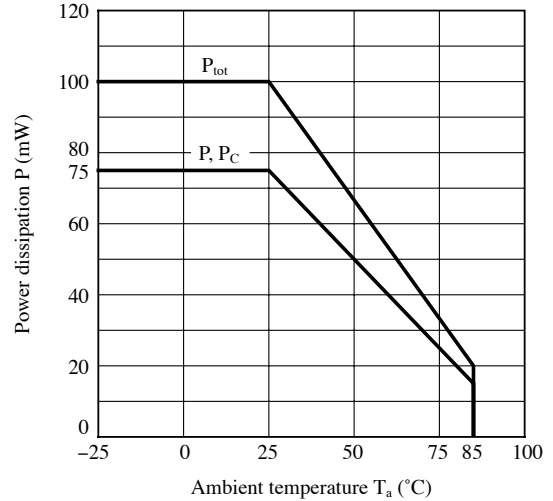

Fig.3 Forward Current vs. Forward Voltage

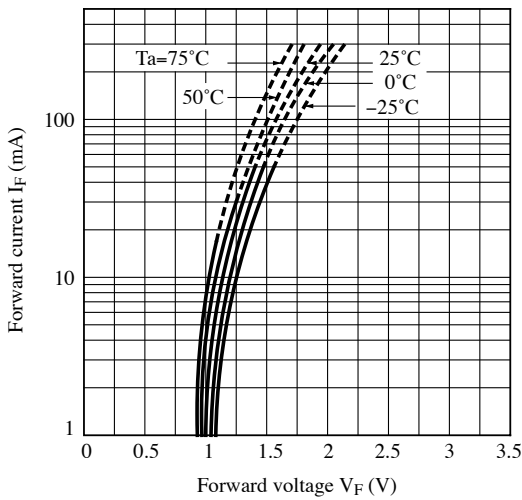

Fig.4 Collector Current vs. Forward Current

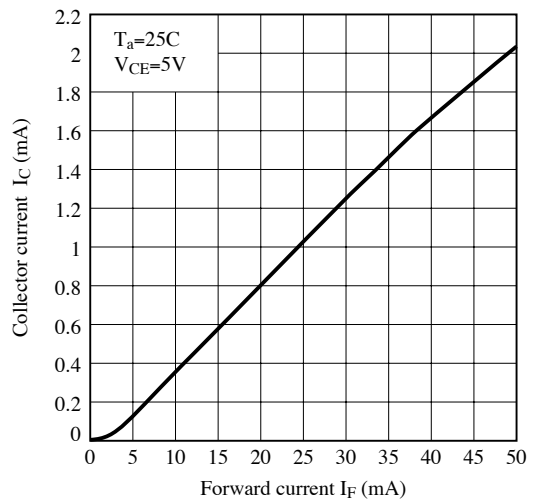

Fig.5 Collector Current vs. Collector-emitter Voltage

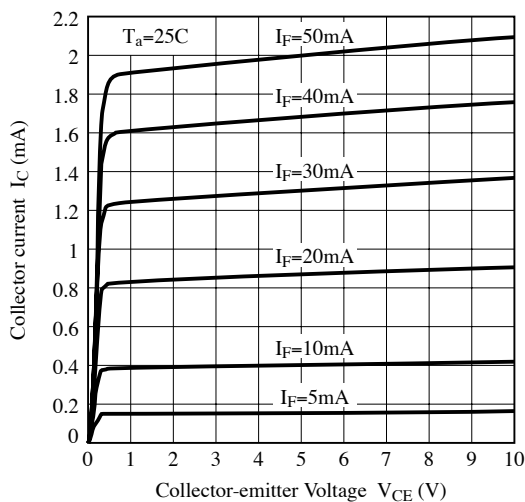

Fig.6 Relative Collector Current vs. Ambient Temperature

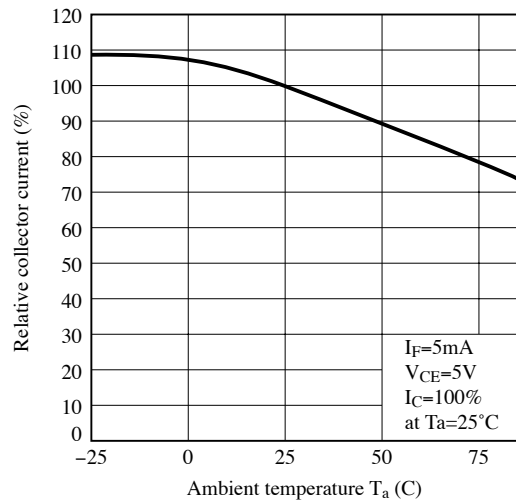

Fig.7 Collector-emitter Saturation Voltage vs. Ambient Temperature **Fig.8 Response Time vs. Load Resistance**

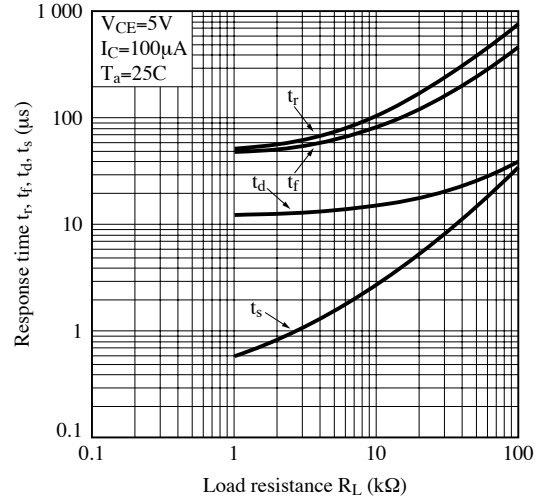
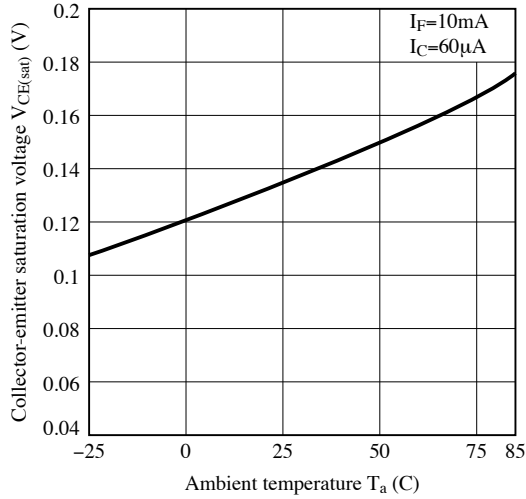

Fig.9 Collector Dark Current vs. Ambient Temperature

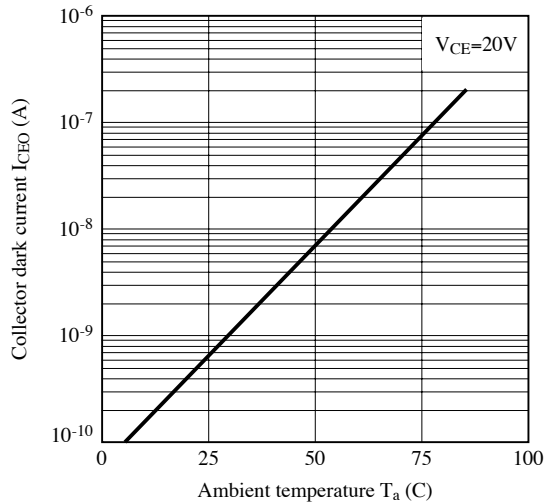
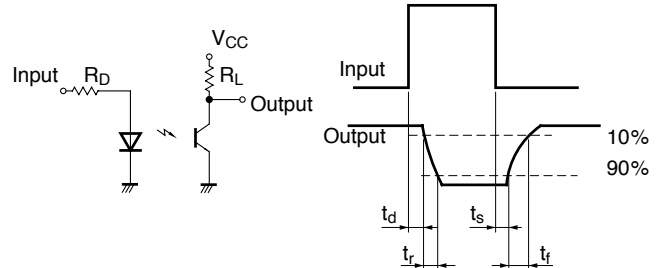

Fig.10 Test Circuit for Response Time



Remarks : Please be aware that all data in the graph are just for reference and not for guarantee.

■ **Design Considerations**

● **Design guide**

1) Prevention of malfunction

To prevent photointerrupter from faulty operation caused by external light, do not set the detecting face to the external light.

Please confirm that there is no mis-operation by magnetic field in use, for prevention of mis-operation by magnetic field.

Please don't let the device put in change of temperature that makes dew for prevention of mis-operation by dew.

If the device is put in the change of temperature which makes dew, please leave the device for enough time in the constant temperature for use.

This product is not designed against irradiation and incorporates non-coherent IRED.

● **Degradation**

In general, the emission of the IRED used in photointerrupter will degrade over time.

In the case of long term operation, please take the general IRED degradation (50% degradation over 5 years) into the design consideration.

● **Parts**

This product is assembled using the below parts.

• Photodetector (qty. : 1)

Category	Material	Maximum Sensitivity wavelength (nm)	Sensitivity wavelength (nm)	Response time (μs)
Phototransistor	Silicon (Si)	800	700 to 1 200	12

• Photo emitter (qty. : 1)

Category	Material	Maximum light emitting wavelength (nm)	I/O Frequency (MHz)
Infrared emitting diode (non-coherent)	Gallium arsenide (GaAs)	950	0.3

• Material

Case	Lead frame	Lead frame plating	Packing case	Metal ball
Black polyphenylene sulfide resin (UL94 V-0)	42Alloy	SnCu plating	Polycarbonate	Fe

■ Manufacturing Guidelines**● Soldering Method**

Flow Soldering:

Soldering should be completed below 260°C and within 5 s.

Please solder within one time.

Soldering area is 1mm or more away from the bottom of housing.

Please take care not to let any external force exert on lead pins.

Please don't do soldering with preheating, and please don't do soldering by reflow.

Hand soldering

Hand soldering should be completed within 2 s when the point of solder iron is below 320°C.

Soldering area is 0.8mm or more away from the bottom of housing.

Please solder within one time.

Soldered product shall treat at normal temperature.

Lead pin

Lead terminals of this product are tin copper alloy plated. Before usage, please evaluate solderability with actual conditions and confirm. And the uniformity in color for the lead terminals are not specified.

Other notice

Please test the soldering method in actual condition and make sure the soldering works fine, since the impact on the junction between the device and PCB varies depending on the tooling and soldering conditions.

● Cleaning instructions

The device shall not be washed with washing material, for there is possibility to remain washing material in internal space of this transmissive type photointerrupter.

● Presence of ODC

This product shall not contain the following materials.

And they are not used in the production process for this product.

Regulation substances : CFCs, Halon, Carbon tetrachloride, 1.1.1-Trichloroethane (Methylchloroform)

Specific brominated flame retardants such as the PBBOs and PBBs are not used in this product at all.

This product shall not contain the following materials banned in the RoHS Directive (2002/95/EC).

•Lead, Mercury, Cadmium, Hexavalent chromium, Polybrominated biphenyls (PBB), Polybrominated diphenyl ethers (PBDE).

■ Package specification**● Sleeve package**

Package materials

Sleeve : Polystyrene

Stopper : Styrene-Butadiene

Package method

MAX. 40 pcs. of products shall be packaged in a sleeve. Both ends shall be closed by tabbed and tabless stoppers.

MAX. 50 sleeves in one case.

■ Important Notices

· The circuit application examples in this publication are provided to explain representative applications of SHARP devices and are not intended to guarantee any circuit design or license any intellectual property rights. SHARP takes no responsibility for any problems related to any intellectual property right of a third party resulting from the use of SHARP's devices.

· Contact SHARP in order to obtain the latest device specification sheets before using any SHARP device. SHARP reserves the right to make changes in the specifications, characteristics, data, materials, structure, and other contents described herein at any time without notice in order to improve design or reliability. Manufacturing locations are also subject to change without notice.

· Observe the following points when using any devices in this publication. SHARP takes no responsibility for damage caused by improper use of the devices which does not meet the conditions and absolute maximum ratings to be used specified in the relevant specification sheet nor meet the following conditions:

(i) The devices in this publication are designed for use in general electronic equipment designs such as:

- Personal computers
- Office automation equipment
- Telecommunication equipment [terminal]
- Test and measurement equipment
- Industrial control
- Audio visual equipment
- Consumer electronics

(ii) Measures such as fail-safe function and redundant design should be taken to ensure reliability and safety when SHARP devices are used for or in connection

with equipment that requires higher reliability such as:

- Transportation control and safety equipment (i.e., aircraft, trains, automobiles, etc.)
- Traffic signals
- Gas leakage sensor breakers
- Alarm equipment
- Various safety devices, etc.

(iii) SHARP devices shall not be used for or in connection with equipment that requires an extremely high level of reliability and safety such as:

- Space applications
- Telecommunication equipment [trunk lines]
- Nuclear power control equipment
- Medical and other life support equipment (e.g., scuba).

· If the SHARP devices listed in this publication fall within the scope of strategic products described in the Foreign Exchange and Foreign Trade Law of Japan, it is necessary to obtain approval to export such SHARP devices.

· This publication is the proprietary product of SHARP and is copyrighted, with all rights reserved. Under the copyright laws, no part of this publication may be reproduced or transmitted in any form or by any means, electronic or mechanical, for any purpose, in whole or in part, without the express written permission of SHARP. Express written permission is also required before any use of this publication may be made by a third party.

· Contact and consult with a SHARP representative if there are any questions about the contents of this publication.