

Product Summary

Part Number	R1 (NOM)	R2 (NOM)	Marking
DDTA144ELP	47kΩ	47kΩ	P2

Features

- Epitaxial Planar Die Construction
- Ultra-Small Leadless Surface Mount Package
- Ideally Suited for Automated Assembly Processes
- **Totally Lead Free & Fully RoHS Compliant (Notes 1 & 2)**
- **Halogen and Antimony Free "Green" Device (Note 3)**
- **Qualified to AEC-Q101 Standards for High Reliability**

X1-DFN1006-3

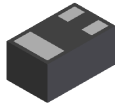

Bottom View

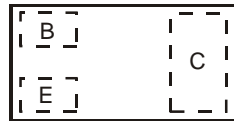

Top View
Pin-Out

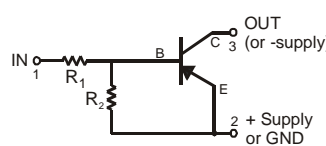

Device Symbol

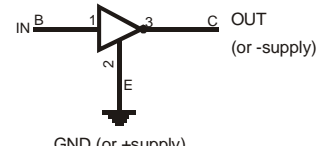

Equivalent Inverter
Circuit

Ordering Information (Note 4)

Product	Marking	Reel size (inches)	Tape width (mm)	Quantity per reel
DDTA144ELP-7	P2	7	8	3,000
DDTA144ELP-7B	P2	7	8	10,000

- Notes:
1. No purposely added lead. Fully EU Directive 2002/95/EC (RoHS) & 2011/65/EU (RoHS 2) compliant.
 2. See http://www.diodes.com/quality/lead_free.html for more information about Diodes Incorporated's definitions of Halogen- and Antimony-free, "Green" and Lead-free.
 3. Halogen- and Antimony-free "Green" products are defined as those which contain <900ppm bromine, <900ppm chlorine (<1500ppm total Br + Cl) and <1000ppm antimony compounds.
 4. For packaging details, go to our website at <http://www.diodes.com>.

Marking Information

<p>DDTA144ELP-7</p>	<div style="display: flex; justify-content: space-around;"> <div style="text-align: center;"> <p>Top View Dot Denotes Collector Side</p> </div> <div style="text-align: center;"> <p>From date code 1527 (YYWW), this changes to:</p> <p>Top View Bar Denotes Base and Emitter Side</p> </div> </div>
<p>DDTA144ELP-7B</p>	<div style="text-align: center;"> <p>Top View Bar Denotes Base and Emitter Side</p> </div> <p style="text-align: right;">P2 = Product Type Marking Code</p>

Absolute Maximum Ratings (@T_A = +25°C, unless otherwise specified.)

Characteristic	Symbol	Value	Unit
Supply Voltage	V _{CC}	-50	V
Input Voltage	V _{IN}	+10 to -40	V
Output Current (I _O)	I _{C(MAX)}	-200	mA

Thermal Characteristics (@T_A = +25°C, unless otherwise specified.)

Characteristic	Symbol	Value	Unit
Power Dissipation (Note 5)	P _D	250	mW
Power Deration above +25°C	P _{der}	2	mW/°C
Thermal Resistance, Junction to Ambient Air (Note 5) (Equivalent to one heated junction of PNP)	R _{θJA}	500	°C/W
Operating and Storage Temperature Range	T _J , T _{STG}	-55 to +150	°C

Electrical Characteristics (@T_A = +25°C, unless otherwise specified.)

Characteristic	Symbol	Min	Typ	Max	Unit	Test Condition
Off Characteristics (Notes 6 & 7)						
Collector-Base Breakdown Voltage	BV _{CBO}	-50	—	—	V	I _C = -10μA, I _E = 0
Collector-Emitter Breakdown Voltage	BV _{CEO}	-50	—	—	V	I _C = -1mA, I _B = 0
Emitter-Base Breakdown Voltage	BV _{EBO}	-4.5	—	—	V	I _E = -100μA, I _C = 0
Collector Cutoff Current	I _{CEX}	—	—	-100	nA	V _{CE} = -50V, V _{EB(OFF)} = 3V
Base Cutoff Current (I _{BEX})	I _{BL}	—	—	-60	μA	V _{CE} = -50V, V _{EB(OFF)} = 3V
Collector-Base Cut Off Current	I _{CBO}	—	—	-100	nA	V _{CB} = -50V, I _E = 0
Collector-Emitter Cut Off Current, I _{O(off)}	I _{CES}	—	—	-100	nA	V _{CE} = -50V, I _B = 0
Emitter-Base Cut Off Current	I _{EBO}	—	—	-100	μA	V _{EB} = -4V, I _C = 0
Input Off Voltage	V _{I(off)}	-300	—	—	mV	V _{CC} = -5V, I _O = -100uA
On Characteristics (Notes 6 & 7)						
Input-On Voltage	V _{I(on)}	—	—	-3	V	V _O = -0.3V, I _O = -5mA
Input Current	I _I	—	—	-180	μA	V _I = -5V
DC Current Gain	h _{FE}	90	—	—	—	V _{CE} = -5V, I _C = -2.5mA
		120	—	—	—	V _{CE} = -5V, I _C = -5mA
		150	—	—	—	V _{CE} = -5V, I _C = -10mA
		100	—	—	—	V _{CE} = -5V, I _C = -100mA
		180	—	—	—	V _{CE} = -5V, I _C = -200mA
Output On Voltage (Collector-Emitter Saturation Voltage)	V _{O(on)}	—	—	-150	mV	I _I = -1mA, I _O = -10mA
		—	—	-800	mV	I _I = -1mA, I _O = -40mA
Input Resistance	R _I	33	47	61	kΩ	—
Resistance Ratio	(R ₂ /R ₁)	0.8	1	1.2	—	—
Small Signal Characteristics						
Current Gain-Bandwidth Product	f _T	—	250	—	MHz	V _{CE} = -10V, I _E = -5mA, f = 100 MHz

- Notes:
- For the device mounted on minimum recommended pad layout 1oz copper that is on a single-sided 1.6mm FR4 PCB; device is measured under still air conditions whilst operating in steady state condition. The entire exposed collector pad is attached to the heatsink.
 - Measured under pulsed conditions. Pulse width ≤ 300μs. Duty cycle ≤ 2%.
 - Guaranteed by design.

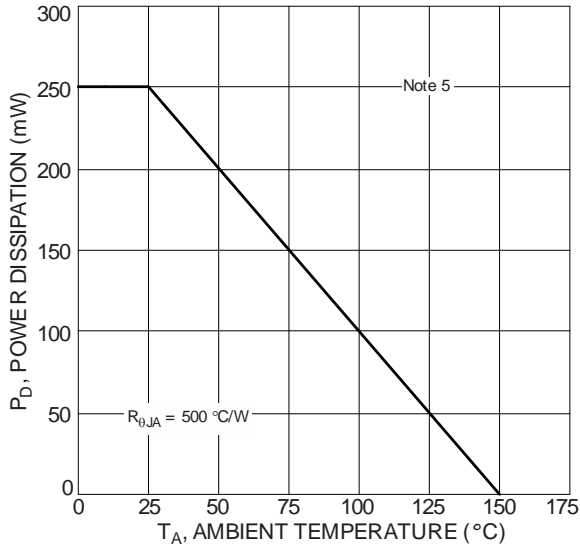

Fig. 1 Power Dissipation vs. Ambient Temperature

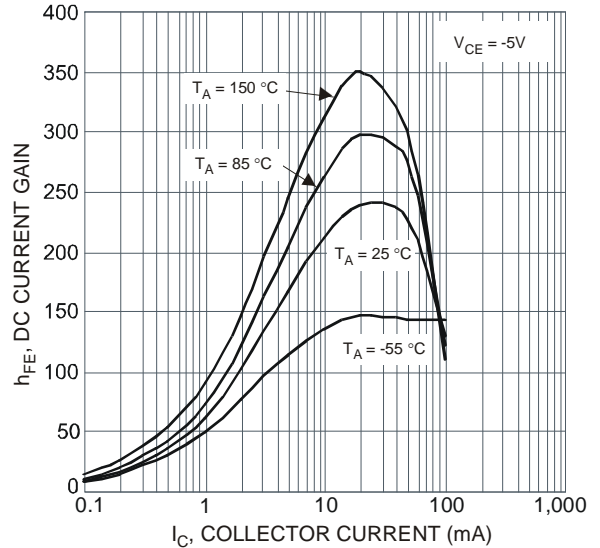

Fig. 2 Typical DC Current Gain vs. Collector Current

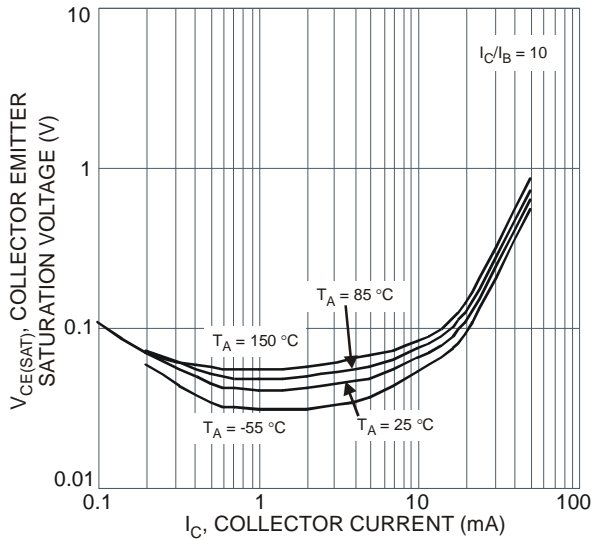

Fig. 3 Typical Collector Emitter Saturation Voltage vs. Collector Current

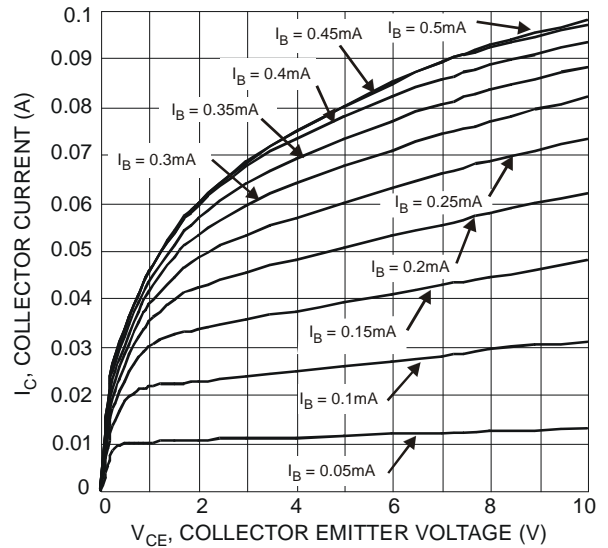

Fig. 4 Typical Collector Emitter Voltage vs. Collector Current

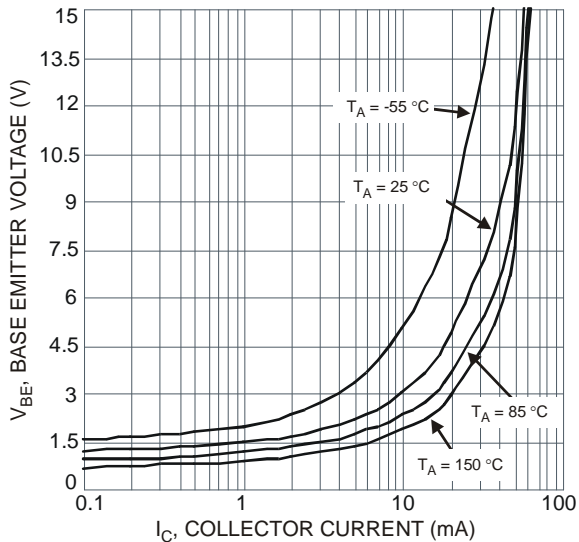

Fig. 5 Typical Base Emitter Voltage vs. Collector Current

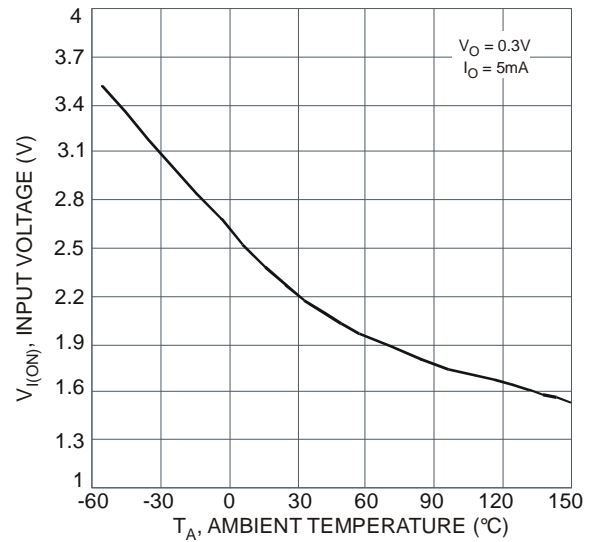

Fig. 6 Typical Input Voltage vs. Ambient Temperature

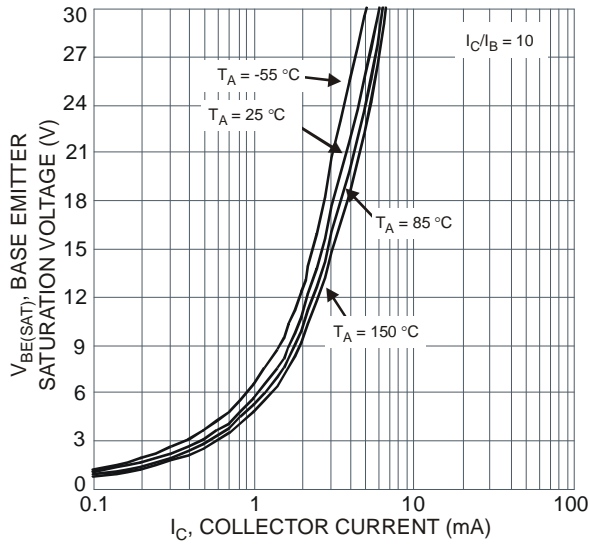
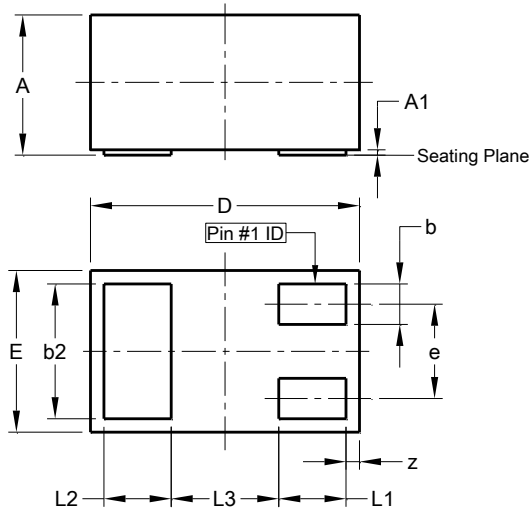

Fig. 7 Typical Base Emitter Saturation Voltage vs. Collector Current

Package Outline Dimensions

Please see AP02002 at <http://www.diodes.com/datasheets/ap02002.pdf> for the latest version.



X1-DFN1006-3			
Dim	Min	Max	Typ
A	0.47	0.53	0.50
A1	0.00	0.05	0.03
b	0.10	0.20	0.15
b2	0.45	0.55	0.50
D	0.95	1.075	1.00
E	0.55	0.675	0.60
e	-	-	0.35
L1	0.20	0.30	0.25
L2	0.20	0.30	0.25
L3	-	-	0.40
z	0.02	0.08	0.05
All Dimensions in mm			

Suggested Pad Layout

Please see AP02001 at <http://www.diodes.com/datasheets/ap02001.pdf> for the latest version.

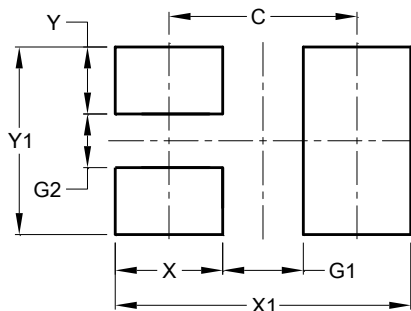

Dimensions	Value (in mm)
C	0.70
G1	0.30
G2	0.20
X	0.40
X1	1.10
Y	0.25
Y1	0.70

IMPORTANT NOTICE

DIODES INCORPORATED MAKES NO WARRANTY OF ANY KIND, EXPRESS OR IMPLIED, WITH REGARDS TO THIS DOCUMENT, INCLUDING, BUT NOT LIMITED TO, THE IMPLIED WARRANTIES OF MERCHANTABILITY AND FITNESS FOR A PARTICULAR PURPOSE (AND THEIR EQUIVALENTS UNDER THE LAWS OF ANY JURISDICTION).

Diodes Incorporated and its subsidiaries reserve the right to make modifications, enhancements, improvements, corrections or other changes without further notice to this document and any product described herein. Diodes Incorporated does not assume any liability arising out of the application or use of this document or any product described herein; neither does Diodes Incorporated convey any license under its patent or trademark rights, nor the rights of others. Any Customer or user of this document or products described herein in such applications shall assume all risks of such use and will agree to hold Diodes Incorporated and all the companies whose products are represented on Diodes Incorporated website, harmless against all damages.

Diodes Incorporated does not warrant or accept any liability whatsoever in respect of any products purchased through unauthorized sales channel. Should Customers purchase or use Diodes Incorporated products for any unintended or unauthorized application, Customers shall indemnify and hold Diodes Incorporated and its representatives harmless against all claims, damages, expenses, and attorney fees arising out of, directly or indirectly, any claim of personal injury or death associated with such unintended or unauthorized application.

Products described herein may be covered by one or more United States, international or foreign patents pending. Product names and markings noted herein may also be covered by one or more United States, international or foreign trademarks.

This document is written in English but may be translated into multiple languages for reference. Only the English version of this document is the final and determinative format released by Diodes Incorporated.

LIFE SUPPORT

Diodes Incorporated products are specifically not authorized for use as critical components in life support devices or systems without the express written approval of the Chief Executive Officer of Diodes Incorporated. As used herein:

A. Life support devices or systems are devices or systems which:

1. are intended to implant into the body, or
2. support or sustain life and whose failure to perform when properly used in accordance with instructions for use provided in the labeling can be reasonably expected to result in significant injury to the user.

B. A critical component is any component in a life support device or system whose failure to perform can be reasonably expected to cause the failure of the life support device or to affect its safety or effectiveness.

Customers represent that they have all necessary expertise in the safety and regulatory ramifications of their life support devices or systems, and acknowledge and agree that they are solely responsible for all legal, regulatory and safety-related requirements concerning their products and any use of Diodes Incorporated products in such safety-critical, life support devices or systems, notwithstanding any devices- or systems-related information or support that may be provided by Diodes Incorporated. Further, Customers must fully indemnify Diodes Incorporated and its representatives against any damages arising out of the use of Diodes Incorporated products in such safety-critical, life support devices or systems.

Copyright © 2015, Diodes Incorporated

www.diodes.com