



User Manual

DS-570

**Graphics-Enhanced Digital
Signage Player Powered by
NVIDIA GeForce GT730M**

ADVANTECH

Enabling an Intelligent Planet

Copyright

The documentation and the software included with this product are copyrighted 2014 by Advantech Co., Ltd. All rights are reserved. Advantech Co., Ltd. also reserves the right to improve the products described in this manual at any time without notice. No part of this manual may be reproduced, copied, translated, or transmitted in any form or by any means without the prior written permission of Advantech Co., Ltd. Information provided in this manual is intended to be accurate and reliable. However, Advantech Co., Ltd. assumes no responsibility for its use, nor for any infringements on the rights of third parties that may result from its use.

Acknowledgements

Award is a trademark of Award Software International, Inc.

IBM, PC/AT, PS/2, and VGA are trademarks of International Business Machines Corporation.

Intel® and Celeron® are trademarks of Intel Corporation.

NVIDIA® is trademark of NVIDIA Corporation

Microsoft Windows® is a registered trademark of Microsoft Corp.

AMI is a registered trademark of American Megatrends Inc.

ESS is a trademark of ESS Technology, Inc.

UMC is a trademark of United Microelectronics Corporation.

SMI is a trademark of Silicon Motion, Inc.

Creative is a trademark of Creative Technology LTD.

CHRONTEL is a trademark of Chrontel Inc.

All other product names or trademarks are the property of their respective owners.

For more information about this and other Advantech products, please visit our website at <http://www.advantech.com/>

For technical support and services, please visit our support website at <http://support.advantech.com.tw/support/>

Product Warranty (2 years)

Advantech warrants the original purchaser that each of its products will be free from defects in materials and workmanship for two years from the date of purchase.

This warranty does not apply to any products that have been repaired or altered by persons other than repair personnel authorized by Advantech, or products that have been subject to misuse, abuse, accident, or improper installation. Advantech assumes no liability under the terms of this warranty as a consequence of such events.

Because of Advantech's high quality-control standards and rigorous testing, most customers never need to use our repair service. If an Advantech product is defective, it will be repaired or replaced at no charge during the warranty period. For out-of-warranty repairs, customers are billed according to the cost of replacement materials, service time, and freight. Please consult your dealer for more details.

If you suspect your product to be defective, follow the steps listed below:

1. Collect all information about the problem encountered (for example, CPU speed, Advantech products used, other hardware and software used, etc.). Note anything abnormal and list any onscreen messages displayed when the problem occurs.
2. Call your dealer and describe the problem. Please have the manual, product, and any relevant information readily available.
3. If your product is diagnosed as defective, obtain an RMA (return merchandise authorization) number from your dealer. This allows us to process your return more quickly.
4. Carefully pack the defective product, a completed Repair and Replacement Order Card, and proof of the purchase date (such as a photocopy of your sales receipt) in a shippable container. Products returned without proof of purchase date are not eligible for warranty service.
5. Write the RMA number clearly on the outside of the package; then ship the product prepaid to your dealer.

Technical Support and Assistance

1. Visit the Advantech website at <http://support.advantech.com> for the latest product information.
2. Contact your distributor, sales representative, or Advantech's customer service center for technical support if you require additional assistance. Please have the following information ready before calling:
 - Product name and serial number
 - Description of your peripheral attachments
 - Description of your software (operating system, version, application software, etc.)
 - A complete description of the problem
 - The exact wording of any error messages

Warnings, Cautions, and Notes

Warning! *Warnings indicate conditions, which if not observed, can cause personal injury!*



Caution! *Cautions are included to help users avoid hardware damage and data loses.*



For example,

“New batteries are at risk of exploding if incorrectly installed. Do not attempt to recharge, force open, or heat the battery. Replace the battery only with the same or equivalent type recommended by the manufacturer. Discard used batteries according to the manufacturer's instructions.”

Note! *Notes provide additional information.*



Battery Information

Batteries, battery packs, and accumulators should not be disposed of as unsorted household waste. Please use public collection systems to return, recycle, or treat these items in compliance with local regulations.

Packing List

Before installation, please ensure that the following items have been shipped:

- 1 x DS-570 unit
- 1 x accessory box containing the items listed below
 - 1 x power adapter bracket set
 - 2 x mount brackets
 - 1 x warranty card
 - 1 x power adapter
 - 1 x China RoHS declaration

Optional Power Cord and Accessories

Part Number	Description
1700001524	3-pin power cord (US)
170203183C	3-pin power cord (EU)
170203180A	3-pin power cord (UK)
1700008921	3-pin power cord with PSE approval (Japan)
1700019146	3-pin power cord with CCC approval (China)

Safety Instructions

1. Read these safety instructions carefully.
2. Retain this user manual for future reference.
3. Disconnect this equipment from all AC outlets before cleaning. Do not use liquid or spray detergents for cleaning. Instead, use only a damp cloth.
4. For pluggable equipment, the power outlet socket should be located nearby and easily accessible.
5. Protect this equipment from humidity.
6. Place this equipment on a reliable surface during installation. Dropping or letting the equipment fall can cause damage.
7. The openings on the enclosure are for air convection to protect the equipment from overheating. Do not cover the openings.
8. Ensure that power voltage is correct before connecting the equipment to a power outlet.
9. Position the power cord so that people cannot step on it. Do not place anything over the power cord.
10. All cautions and warnings on the equipment should be noted.
11. If not used for a long time, disconnect the equipment from the power source to avoid damage by transient overvoltage.
12. Never pour liquid into the openings. This can cause fire or electrical shock.
13. Never open the equipment. For safety reasons, the equipment should only be opened by qualified service personnel.
14. If one of the following occurs, have the equipment checked by authorized service personnel:
 - The power cord or plug is damaged.
 - Liquid has penetrated the equipment.
 - The equipment has been exposed to moisture.
 - The equipment is malfunctioning, or does not operate according to the user manual.
 - The equipment has been dropped or damaged.
 - The equipment shows obvious signs of breakage.
15. Do not store this equipment in an environment where the temperature fluctuates below -20 °C (-4 °F) or above 60 °C (140 °F) as this can cause damage. The equipment should be stored in a controlled environment.
16. **CAUTION:** Batteries are at risk of exploding if incorrectly installed. Replace only with the same or equivalent type recommended by the manufacturer. Discard used batteries according to the manufacturer's instructions.

The sound pressure at the operator position does not exceed 70 dB (A), as per IEC 704-1:1982.

DISCLAIMER: These instructions are provided according to IEC 704-1. Advantech disclaims all responsibility for the accuracy of all statements contained herein.

Contents

Chapter 1	General Introduction	1
1.1	Introduction	2
1.2	Product Features.....	2
1.2.1	General	2
1.2.2	Display	2
1.2.3	Power Consumption.....	2
1.3	Hardware Specifications	3
1.4	Mechanical Specifications.....	4
	Figure 1.1 DS-570 mechanical dimensions	4
1.5	Power Requirements.....	4
1.6	Environmental Specifications	4
Chapter 2	Hardware Installation	5
2.1	DS-570 Front and Rear Views	6
	Figure 2.1 Front view	6
	Figure 2.2 Rear view.....	6
2.2	DS-570 Front External I/O Connectors	6
2.2.1	Power ON/OFF Button.....	6
	Figure 2.3 Power button	6
2.2.2	USB Connectors	6
	Figure 2.4 USB connector	7
	Table 2.1: USB Port Pin Assignments	7
2.2.3	Ethernet Connector (LAN)	7
	Figure 2.5 LAN connector.....	7
	Table 2.2: LAN Connector Pin Assignments	7
2.2.4	COM Connector	8
	Figure 2.6 COM connector	8
	Table 2.3: COM Port Pin Assignments	8
2.2.5	Audio Connector	8
	Figure 2.7 Audio connector.....	8
2.2.6	S/PDIF Connector.....	8
	Figure 2.8 S/PDIF connector	8
2.3	DS-570 Rear External I/O Connectors	8
2.3.1	Power Input Connector	8
	Figure 2.9 DC input connector.....	9
2.3.2	VGA Connector.....	9
	Figure 2.10VGA connector	9
	Table 2.4: VGA Connector Pin Assignments.....	9
2.3.3	HDMI Connector	9
	Figure 2.11HDMI connector.....	10
	Table 2.5: HDMI Connector Pin Assignments	10
2.3.4	DP++ Connector	11
	Figure 2.12DP++ connector.....	11
	Table 2.6: DP++ Connector Pin Assignments	11
2.3.5	USB Connectors	12
	Figure 2.13USB 3.0 connector	12
	Table 2.7: USB 3.0 Connector Pin Assignments	12
2.4	Hardware Installation	13
2.4.1	Memory Installation.....	13
	Figure 2.14Memory module installation.....	13
2.4.2	HDD Installation	14
	Figure 2.15HDD installation	14
2.4.3	Mini PCIe and SIM Card Installation	15

	Figure 2.16 Mini PCIe and SIM card installation	15
2.4.4	Wireless LAN Antenna Installation	16
	Figure 2.17 Wireless LAN antenna installation.....	16

Chapter 3 BIOS Settings 17

3.1	BIOS Introduction.....	18
3.2	Entering Setup	18
3.2.1	Main Setup.....	18
	Figure 3.1 Main setup screen	18
3.2.2	Advanced BIOS Features Setup.....	19
	Figure 3.2 Advanced BIOS Features setup screen	19
	Figure 3.3 ACPI setup screen	20
	Figure 3.4 HW monitoring screen.....	21
	Figure 3.5 S5 RTC wake setup screen.....	21
	Figure 3.6 CPU configuration setup screen.....	22
	Figure 3.7 IDE configuration setup screen	23
	Figure 3.8 Miscellaneous Configuration setup screen.....	24
	Figure 3.9 USB Configuration setup screen	25
	Figure 3.10 Intel® TXE Configuration setup screen	25
3.2.3	Chipset BIOS Feature Setup	26
3.2.4	Security BIOS Feature Setup	27
	Figure 3.11 Security Configuration setup screen	27
3.2.5	Boot BIOS Feature Setup	28
	Figure 3.12 Boot Configuration setup screen	28
3.2.6	Save & Exit BIOS Feature Setup.....	29
	Figure 3.13 Save & Exit Configuration setup screen.....	29

Chapter 4 Software 31

4.1	Intel® TXE Driver Installation.....	32
-----	-------------------------------------	----

Chapter 1

General Introduction

This chapter gives background information regarding the DS-570 series.

1.1 Introduction

DS-570 is powered by an Intel® Celeron® N2930/J1900 quad-core processor with an integrated NVIDIA GeForce GT730M graphics module for UHD playback. DS-570 delivers advanced graphics performance at low cost to satisfy various signage application requirements.

DS-570 features four display output interfaces (2 x HDMI, 1 x DP++, and 1 x VGA) to accommodate up to four simultaneous display outputs. For superior connectivity, DS-570 supports two mini PCIe interfaces with add-on functions such as wireless networks and TV tuner cards to fulfill various requirements. DS-570 also supports two GLAN, four USB ports (3 x USB 2.0, 1 x USB 3.0), two COM (RS-232) ports, and several audio (SPDIF/line-out and mic-in) ports to facilitate system and application integration.

1.2 Product Features

1.2.1 General

- Supports an Intel® Celeron® N2930 quad-core 1.86 GHz onboard CPU (CPU TDP up to 7.5 W) or a Celeron® J1900 quad-core 2.0 GHz onboard CPU (CPU TDP up to 10 W)
- Supports two HDMI (HDMI 1 with CEC support) ports, one DP++, and one VGA for multiple displays
- Supports two GbE, one USB 3.0, three USB 2.0, and two COM (RS-232) ports
- Internal 2.5-inch SATA HDD/SSD bay for storage devices
- Two built-in mini PCIe slots for easy expansion, e.g. Wi-Fi, TV tuner, etc.
- Easy integration and maintenance

1.2.2 Display

- **Multiple display support**
 - Can accommodate up to four simultaneous display outputs.
 - HDMI and DP++ with a maximum resolution of 4K2K (3840 x 2160 pixels)
 - Can supports UHD video playback (subject to the video media format and playback software)

1.2.3 Power Consumption

- **CPU N2930:**
 - Typical: 10.5 W (w/o expansion)
 - Maximum: 15.7 W (w/o expansion)
- **CPU J1900:**
 - Typical: 9.7 W (w/o expansion)
 - Maximum: 22.6 W (w/o expansion)

1.3 Hardware Specifications

- **CPU:** Intel® Celeron® N2930 quad-core 1.86 GHz onboard CPU, or Celeron® J1900 quad-core 2.0 GHz onboard CPU
- **System Chipset:** System-on-Chip solution
- **BIOS:** AMI uEFI 64 Mbit Flash BIOS
- **System Memory:** 2 x DDR3 SODIMM sockets support up to 8 GB of DDR3L 1333 MHz memory (Max. 4 GB per SODIMM socket)
- **Graphics Chipset:** NVIDIA GeForce GT730M
- **HDD:** Supports 1 x 2.5" SATA HDD (7 mm height only)
- **SSD:** Shared with the 2.5" SATA HDD bay (7 mm height only)
- **Watchdog Timer:** Supported by Advantech SUSI API
- **I/O Interface:** 2 x RS-232
- **USB:** 1 x USB 3.0 and 3 x USB 2.0-compliant ports
- **Audio:** Supports one audio jack, default is mic-in (jack sense also supported), and one S/SPDIF/ line out
- **Ethernet Chipset:** 2 x Intel I211 (Gigabit LAN)
 - Speed: 10/100/1000 Mbps
 - Interface: 1 x RJ-45 jacks with LED
 - Standard: IEEE 802.3z/ab (1000 Base-T) or IEEE 802.3u 100 Base-T compliant
- **Expansion:**
 - Two internal mini PCIe sockets (full-size mini PCIe2 slot with SIM card support)
- **Resolution:**
 - HDMI: Up to 3840 x 2160 @ 30 Hz (UHD)
 - DP++: Up to 3840 x 2160 @ 30 Hz (UHD)
 - VGA: Up to 2048 x 1536 @ 60 Hz

Caution! For systems with only one RAM module, please insert the module into the SODIMM 1 slot before system bootup.



1.4 Mechanical Specifications

- **Dimensions:** 220.0 x 150.0 x 44.2 mm (8.67" x 5.91" x 1.74") (L x W x H)

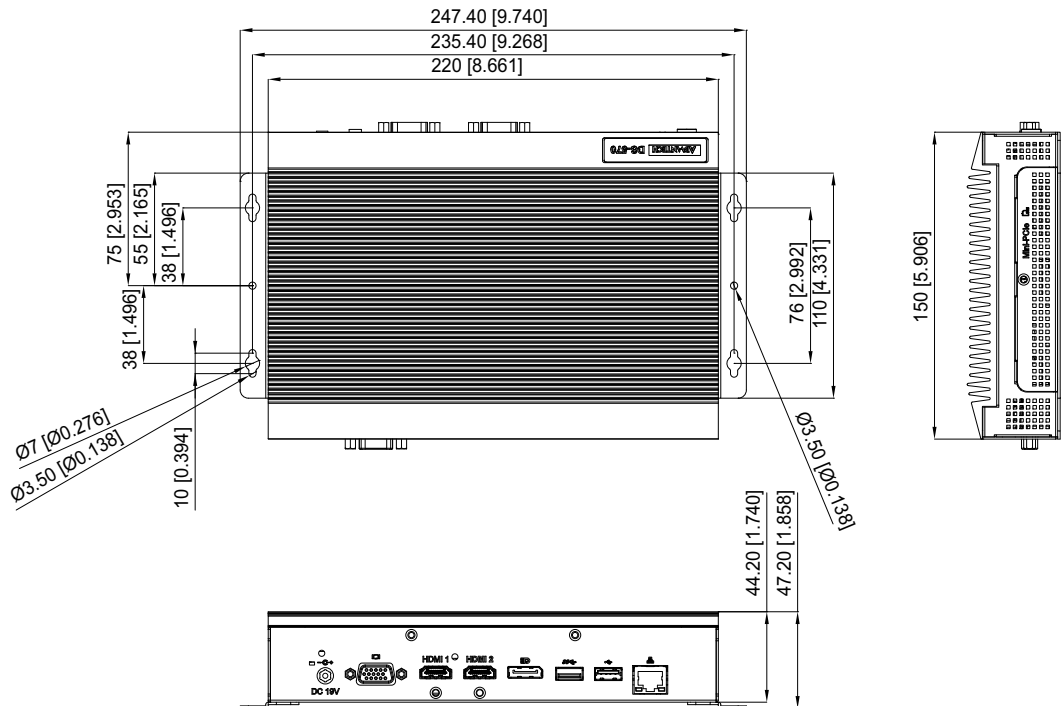

Figure 1.1 DS-570 mechanical dimensions

- **Weight:** 1.7 kg (3.75 lb)

1.5 Power Requirements

- **System Power:**
 - Minimum power input: 19 V DC, 3.42 A
- **RTC Battery:** 3 V/195 mA/HR BR2032

1.6 Environmental Specifications

- **Operating Temperature:** 0 ~ 40 °C (32 ~ 104 °F) / 0 ~ 70 °C (32 ~ 158 °F) with extended temperature RAM and SSD
- **Relative Humidity:** 95% @ 40 °C (non-condensing)
- **Storage Temperature:** -20 ~ 70 °C (-4 ~ 167 °F)
- **Vibration Loading During Operation:** 1.0 Grms, IEC 60068-2-64, random, 5 ~ 500 Hz, 1 Oct./min, 1 hr/axis.
- **Shock During Operation:** 10 G, IEC 60068-2-27, half sine, 11 ms duration
- **Safety:** UL, BSMI, CCC, CB, LVD
- **EMC:** CE, FCC Class B, BSMI

Chapter 2

Hardware Installation

This chapter describes the DS-570 hardware installation process and external I/O.

2.1 DS-570 Front and Rear Views

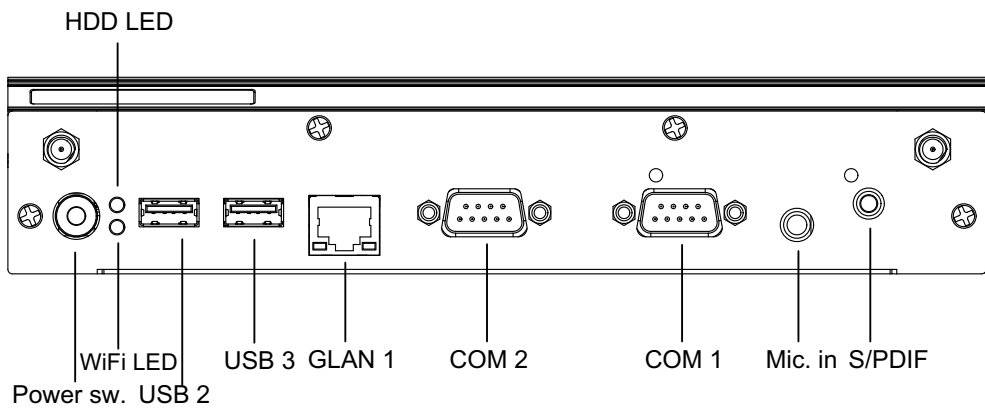

Figure 2.1 Front view

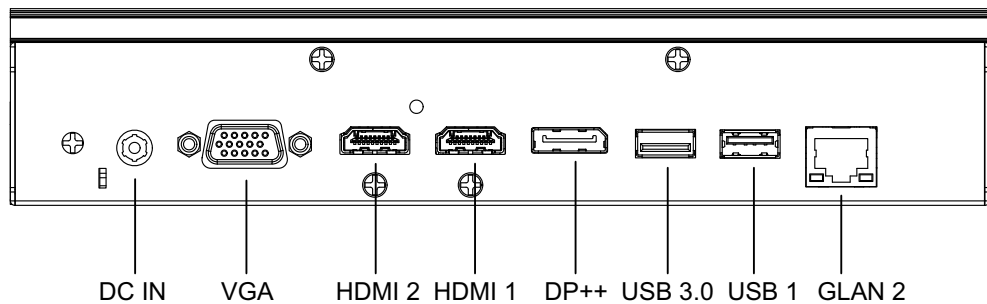

Figure 2.2 Rear view

2.2 DS-570 Front External I/O Connectors

2.2.1 Power ON/OFF Button

DS-570 features a power ON/OFF button on the front of the device. Push this button to turn the system on or off. DS-570 also supports the 4-second delay soft power off function.



Figure 2.3 Power button

2.2.2 USB Connectors

On the front of the DS-570 device are two USB 2.0 interface connectors that provide complete plug-and-play and hot-swapping capabilities for up to 127 external devices. The two USB 2.0 interfaces are compliant with USB UHCI specification, Rev. 2.0. The USB ports support plug-and-play installation, which enables users to connect or disconnect a device without turning off the computer.

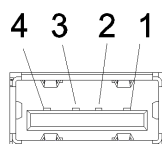

Figure 2.4 USB connector

Table 2.1: USB Port Pin Assignments

Pin	Signal Name
1	VCC
2	USB Data-
3	USB Data+
4	GND

2.2.3 Ethernet Connector (LAN)

DS-570 provides two RJ45 LAN interface connectors (1 x LAN at the front and 1 x LAN at the rear) that are fully compliant with IEEE 802.3u 10/100/1000 Base-T CSMA/CD standards. The Ethernet port at the front supports a standard RJ-45 jack connector with LED indicators for denoting its active/link and speed status.

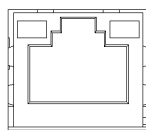

Figure 2.5 LAN connector

Table 2.2: LAN Connector Pin Assignments

Pin	Signal Name
1	MDI0+
2	MDI0-
3	MDI1+
4	MDI1-
5	GND
6	GND
7	MDI2+
8	MDI2-
9	MDI3+
10	MDI3-
11	VCC
12	ACT
13	Link100#
14	Link1000#

2.2.4 COM Connector

DS-570 features two D-sub 9-pin connector serial communication interface ports. These ports also support RS-232-mode communication.

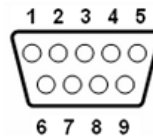

Figure 2.6 COM connector

Table 2.3: COM Port Pin Assignments

Pin	Signal Name
1	DCD
2	RxD
3	TxD
4	DTR
5	GND
6	DSR
7	RTS
8	CTS
9	RI

2.2.5 Audio Connector

A microphone can be connected to the audio jack (only supports mic-in function).

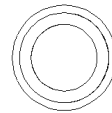

Figure 2.7 Audio connector

2.2.6 S/PDIF Connector

The S/PDIF port allows users to send digital audio to an amplifier or television, and also supports jack sensing and line-out function.

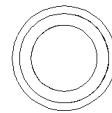

Figure 2.8 S/PDIF connector

2.3 DS-570 Rear External I/O Connectors

2.3.1 Power Input Connector

DS-570 is equipped with a DC jack header that supports 19 V DC power input.

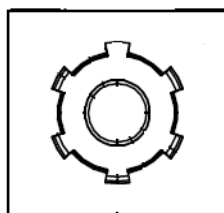

Figure 2.9 DC input connector

2.3.2 VGA Connector

DS-570 features one high-resolution VGA interface connected by a D-sub 15-pin connector to support VGA CRT-compatible monitors. The connector provides display resolutions of up to 2048 x 1536 @ 60 Hz.

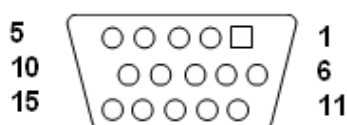

Figure 2.10 VGA connector

Table 2.4: VGA Connector Pin Assignments

Pin	Signal Name
1	RED
2	GREEN
3	BLUE
4	NC
5	GND
6	GND
7	GND
8	GND
9	NC
10	GND
11	NC
12	DDC DAT
13	H-SYNC
14	V-SYNC
15	DDC CLK

2.3.3 HDMI Connector

DS-570 features two HDMI connectors that provide all-digital audio/video interfaces for transmitting uncompressed audio/video signals. However, only HDMI 1 supports high-bandwidth digital content protection (HDCP). Thus, all HDMI audio/video devices should be connected to this port. Although HDMI technology can support a maximum resolution of 3840 x 2160p, the actual display resolutions depend on the monitor used.

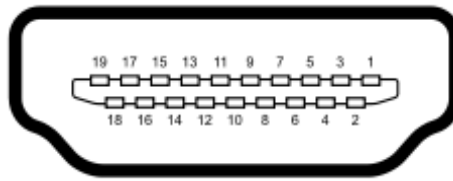

Figure 2.11 HDMI connector

Table 2.5: HDMI Connector Pin Assignments

Pin	Signal Name
1	TMDS Data2+
2	GND
3	TMDS Data2-
4	TMDS Data1+
5	GND
6	TMDS Data1-
7	TMDS Data0+
8	GND
9	TMDS Data0-
10	TMDS Clock+
11	GND
12	TMDS Clock-
13	NC
14	NC
15	SCL
16	SDA
17	GND
18	+5 V Power
19	Detect

2.3.4 DP++ Connector

The DS-570 DP++ connector not only supports DP output, but can also directly output single-link HDMI and DVI signals using a simple passive adapter. Although a maximum resolution of 3840 x 2160p is supported, the actual display resolutions depend on the monitor used.

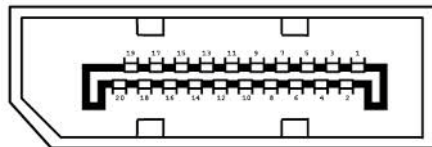

Figure 2.12 DP++ connector

Table 2.6: DP++ Connector Pin Assignments

Pin	Signal Name
1	ML_Lane 0 (p)
2	GND
3	ML_Lane 0 (n)
4	ML_Lane 1 (p)
5	GND
6	ML_Lane 1 (n)
7	ML_Lane 2 (p)
8	GND
9	ML_Lane 2 (n)
10	ML_Lane 3 (p)
11	GND
12	ML_Lane 3 (n)
13	CONFIG1
14	CONFIG2
15	AUX CH (p)
16	GND
17	AUX CH (n)
18	Hot Plug
19	Return
20	DP_PWR

2.3.5 USB Connectors

On the rear of the DS-570 device are two USB interface connectors (1 x USB 2.0 and 1 x USB 3.0) that provide complete plug-and-play and hot-swapping capabilities for up to 127 external devices. The three USB 2.0 interfaces are compliant with USB UHCI specification, Rev. 2.0, and the USB 3.0 interface is compliant with USB UHCI specification, Rev. 3.0. All USB ports support plug-and-play installation, which enables users to connect or disconnect a device without turning off the computer. Refer to Table 2.1 for USB 2.0 pin assignments.

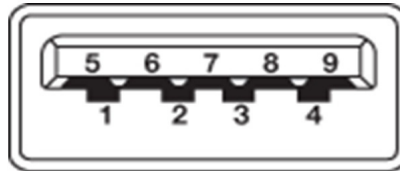

Figure 2.13 USB 3.0 connector

Table 2.7: USB 3.0 Connector Pin Assignments

Pin	Signal Name
1	VBUS
2	USB Data-
3	USB Data+
4	GND
5	StdA_SSRX-
6	StdA_SSRX+
7	GND_DRAIN
8	StdA_SSTX-
9	StdA_SSTX+

2.4 Hardware Installation

2.4.1 Memory Installation

1. Remove the mini PCIe slot cover and HDD cover by loosening the five fixing screws.
2. Remove the heatsink by loosening the four fixing screws on the front and rear panels, as well as the two fixing screws inside the chassis.
3. Insert the memory module into the memory socket.
4. Perform the above steps in reverse to reassemble the system.

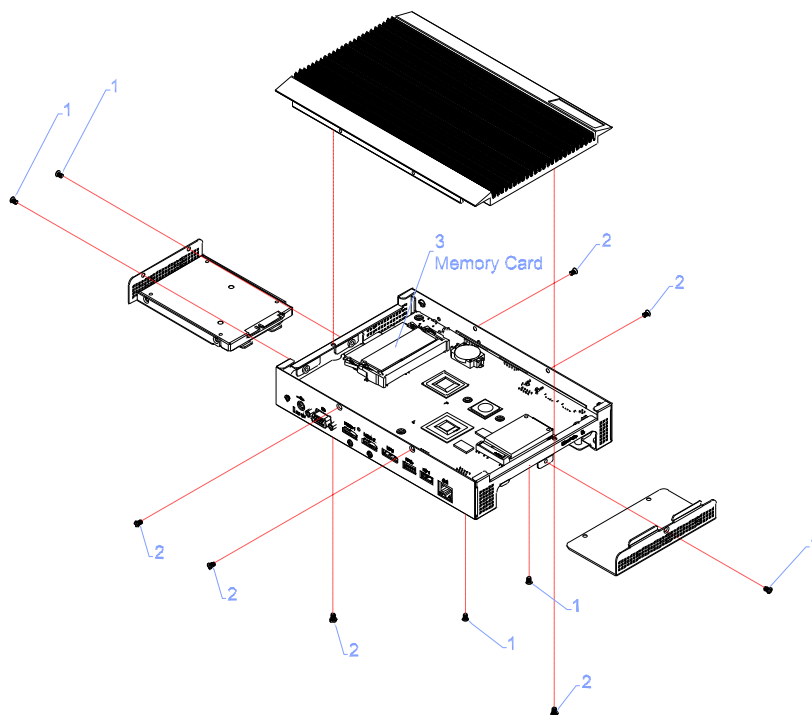

Figure 2.14 Memory module installation

2.4.2 HDD Installation

1. Attach the 2.5-inch SATA HDD to the HDD bracket by tightening the four fixing screws.
2. Insert the HDD module into the system.
3. Reassemble the HDD cover by tightening the two fixing screws.

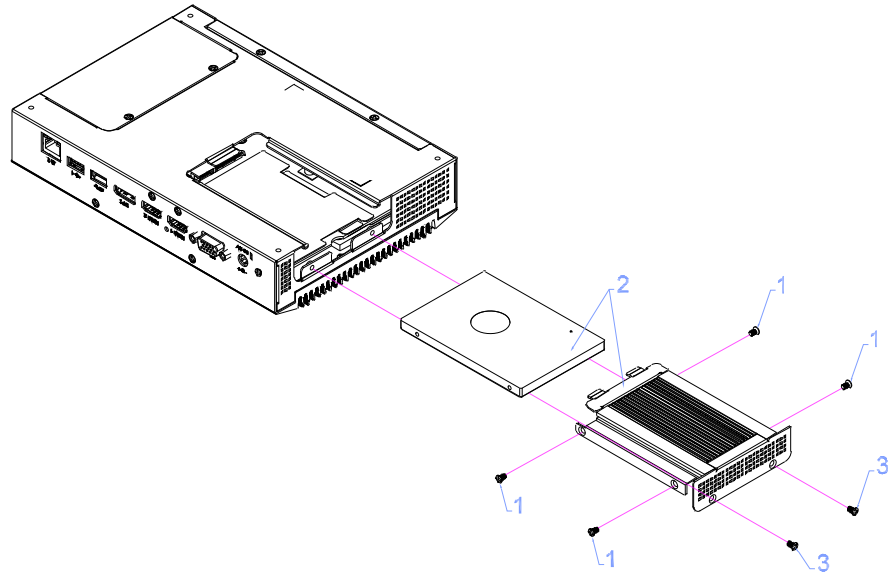

Figure 2.15 HDD installation

2.4.3 Mini PCIe and SIM Card Installation

1. Remove the mini PCIe slot cover by loosening the three fixing screws.
2. Insert a mini PCIe card into the card slot or insert a SIM card into the SIM card slot. (Note: The SIM card slot is located under the mini PCIe card slot. Do not mix them up.)
3. Reattach the mini PCIe slot cover by tightening the fixing screws.

Note 1 Mini PCIe 1 supports mSATA and mini PCIe cards.



Note 2 The SIM card slot is located under the mini PCIe 2 slot.

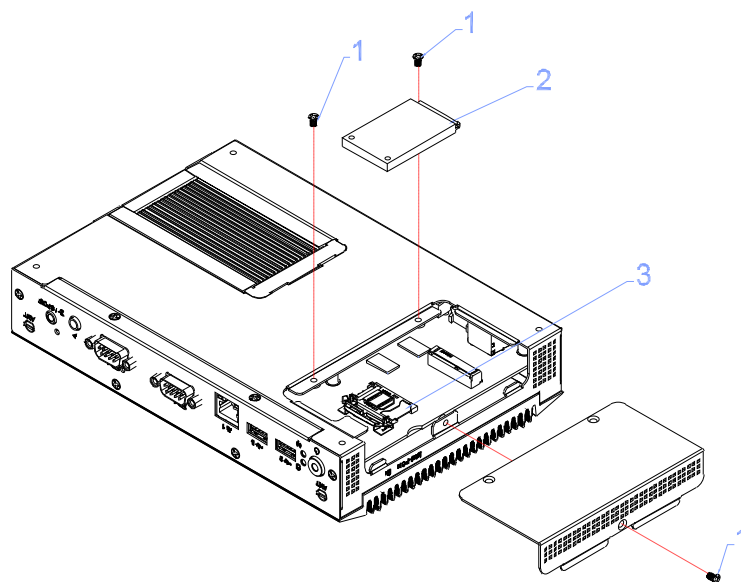

Figure 2.16 Mini PCIe and SIM card installation

2.4.4 Wireless LAN Antenna Installation

1. Refer to previous sections for instructions regarding removing the mini PCIe slot cover and HDD cover.
2. Remove the heatsink by loosening the four fixing screws on the front and rear I/O panels, as well as the two fixing screws inside the chassis. Then loosen the four fixing screws on the front panel to remove the front cover.
3. Attach the antenna onto the front I/O panel.
4. Reassemble the system.

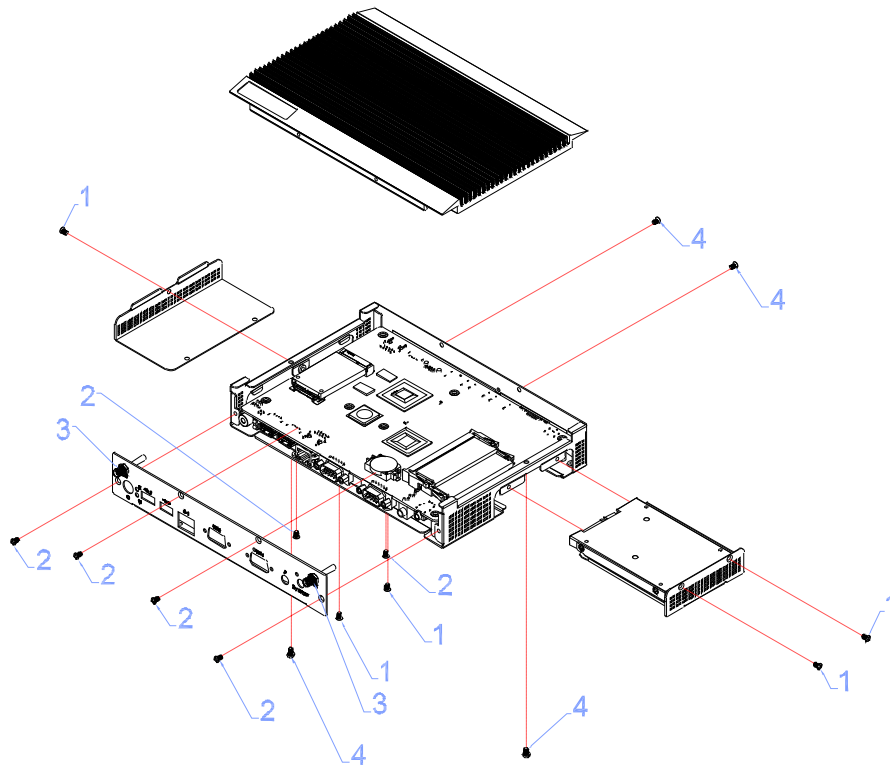

Figure 2.17 Wireless LAN antenna installation

Chapter 3

BIOS Settings

This chapter explains the BIOS configuration process.

3.1 BIOS Introduction

With the AMI BIOS Setup program, users can modify the BIOS settings and control various system features. This chapter describes the basic navigation of the DS-570 series BIOS setup screens.

AMI BIOS's ROM features a built-in setup program that allows users to modify the basic system configuration. These settings are stored in the flash portion of the CMOS to retain the setup information even when the system is powered off.

3.2 Entering Setup

3.2.1 Main Setup

When initially entering the BIOS Setup Utility, users are presented with the Main setup screen. Users can always return to the Main setup screen by selecting the Main tab.

The Main BIOS setup screen features two main frames. All configurable options are displayed in the left frame. The options presented in blue text can be configured, whereas grayed-out options cannot be configured. In the right frame, the key legend is displayed. The area above the key legend is reserved for text messages. When an option in the left frame is selected, the text color becomes white. This is often accompanied by a text message in the upper right frame.



Figure 3.1 Main setup screen

■ System Time/System Date

Use this option to change the system time and date. Highlight System Time or System Date using the <Arrow> keys. Enter new values using the keyboard. Press the <Tab> or <Arrow> keys to move between fields. The date must be entered in MM/DD/YY format, and the time must be entered in HH:MM:SS format.

3.2.2 Advanced BIOS Features Setup

Select the Advanced tab in the DS-570 BIOS Setup Utility to enter the Advanced BIOS setup screen. Highlight any items in the left frame, such as CPU configuration, and press <Enter> to access the submenu for that item. Users can view the Advanced BIOS Setup options for any item by highlighting the item using the <Arrow> keys. All Advanced BIOS Setup options are described in this section. The Advanced BIOS setup screen is shown below. The submenus are described in the following pages.

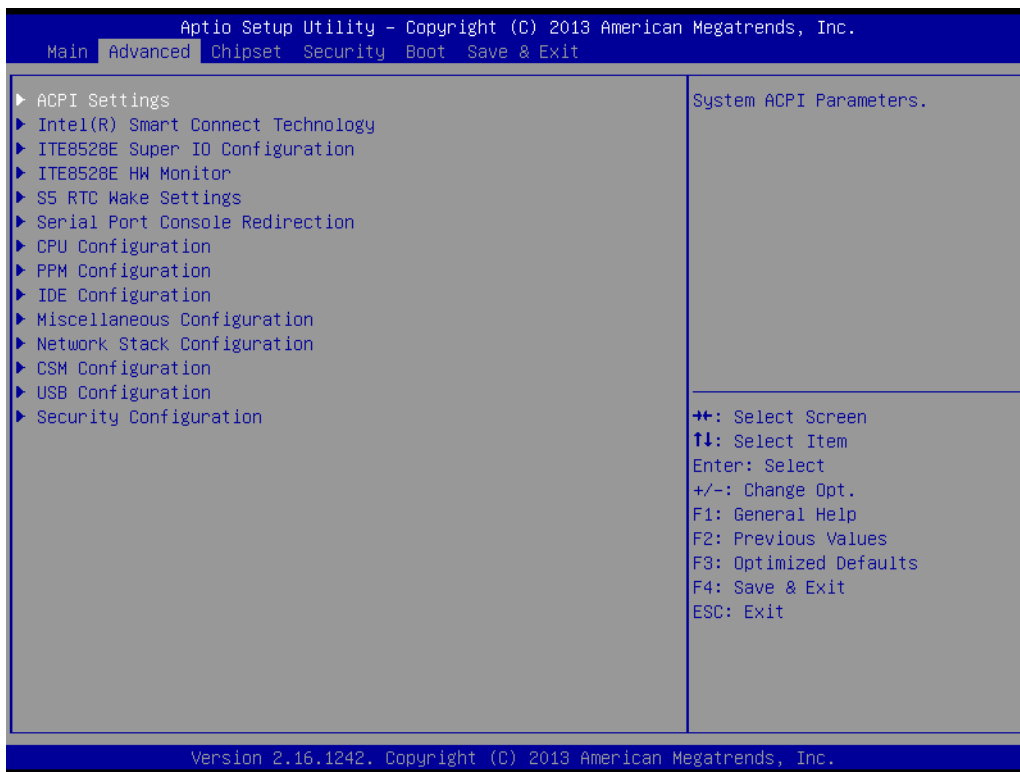

Figure 3.2 Advanced BIOS Features setup screen

- **ACPI Settings**
System ACPI Parameters

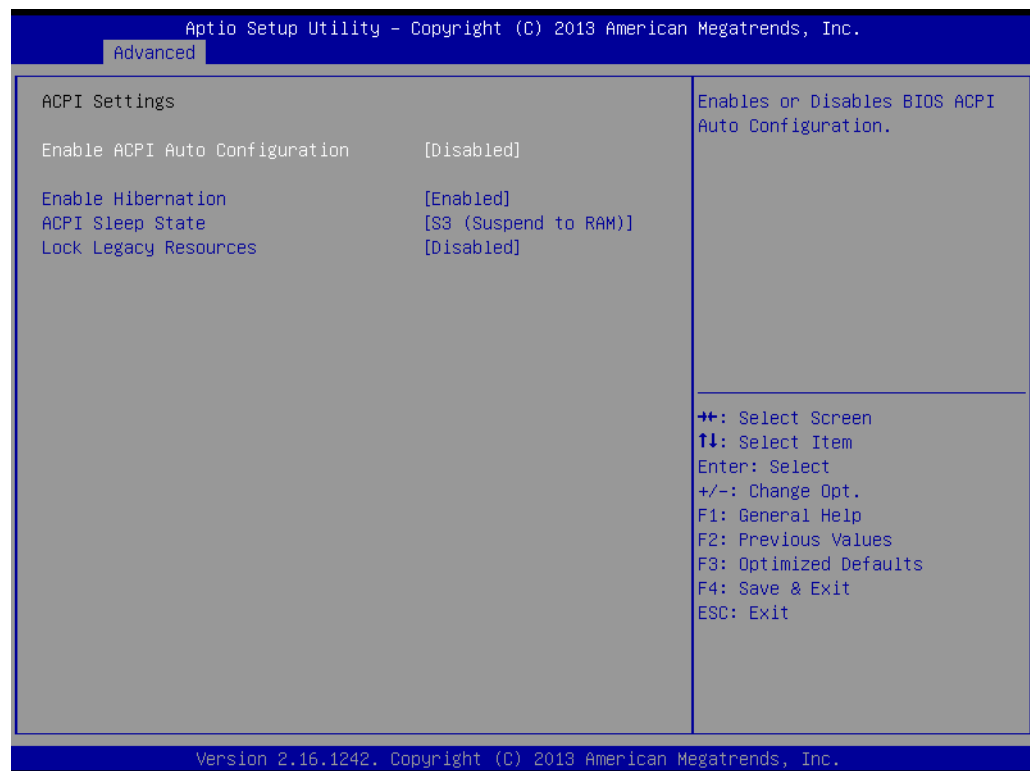

Figure 3.3 ACPI setup screen

- **Intel® Smart Connect Technology**
Intel® Smart Connect Technology settings
 - **ISCT Notification Control**
Enable/disable ISCT support
 - **ISCT WLAN Power Control**
Enable/disable ISCT WLAN power support
 - **ISCT WWAN Power Control**
Enable/disable ISCT WWAN power support
 - **ISCT Sleep Duration Value Format**
The ISCT sleep duration value is presented in seconds; the standard time format is not supported
 - **ISCT RF Kill Switch Type**
Software/hardware ISCR RF kill switch type
 - **ISCT RTC Timer Support**
Enable/disable the ISCT RTC timer

- **ITE8528E Super I/O Configuration**
System Super I/O chip parameters

- **ITE8528E HW Monitor**
Monitor hardware status (PC health status)

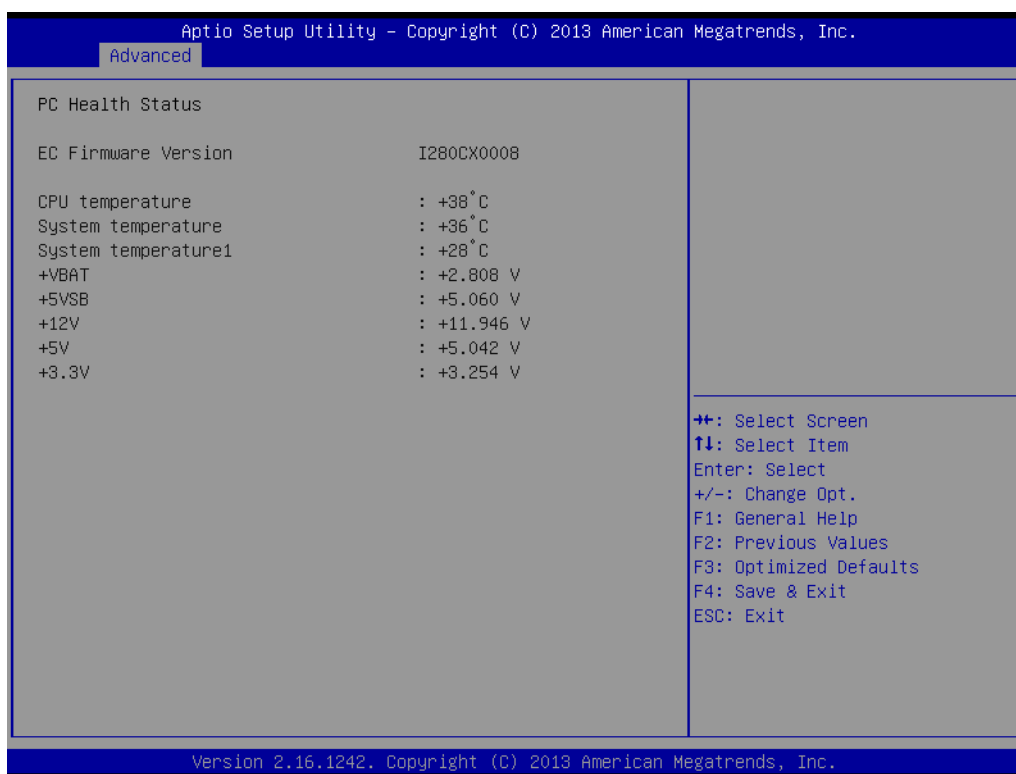

Figure 3.4 HW monitoring screen

- **S5 RTC Wake Settings**
Enable/disable system wake from S5 using RTC alarm

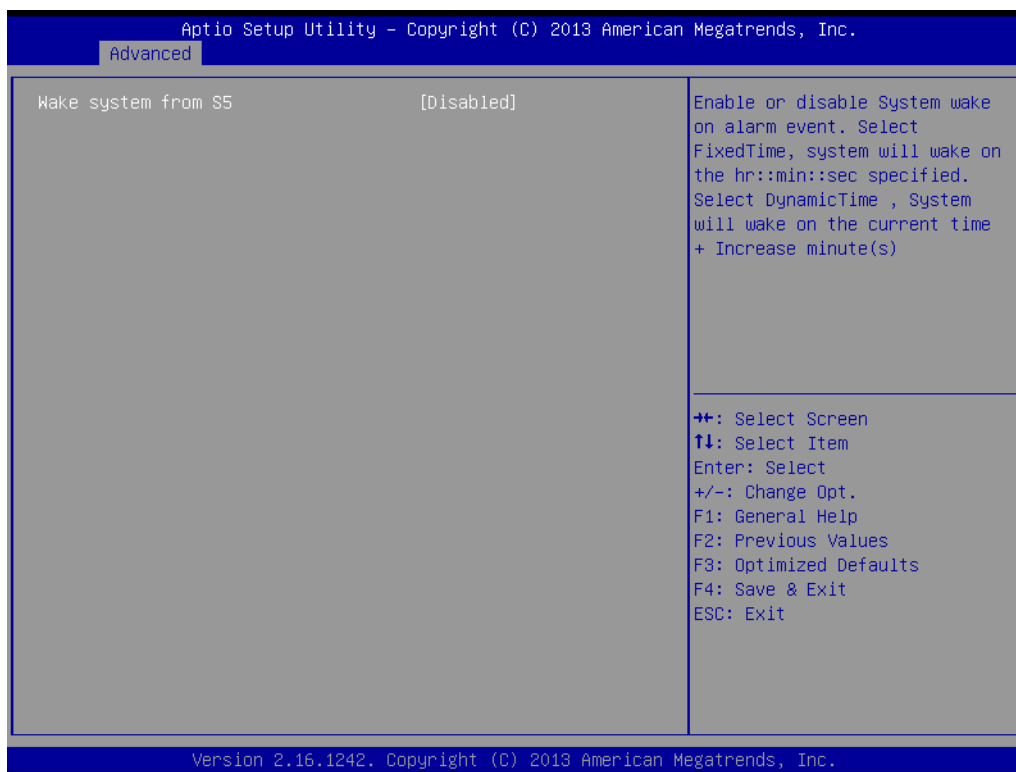

Figure 3.5 S5 RTC wake setup screen

- **Serial Port Console Redirection**
Enable/disable Serial Port Console redirection

- **CPU Configuration**
Allows users to adjust the CPU configuration

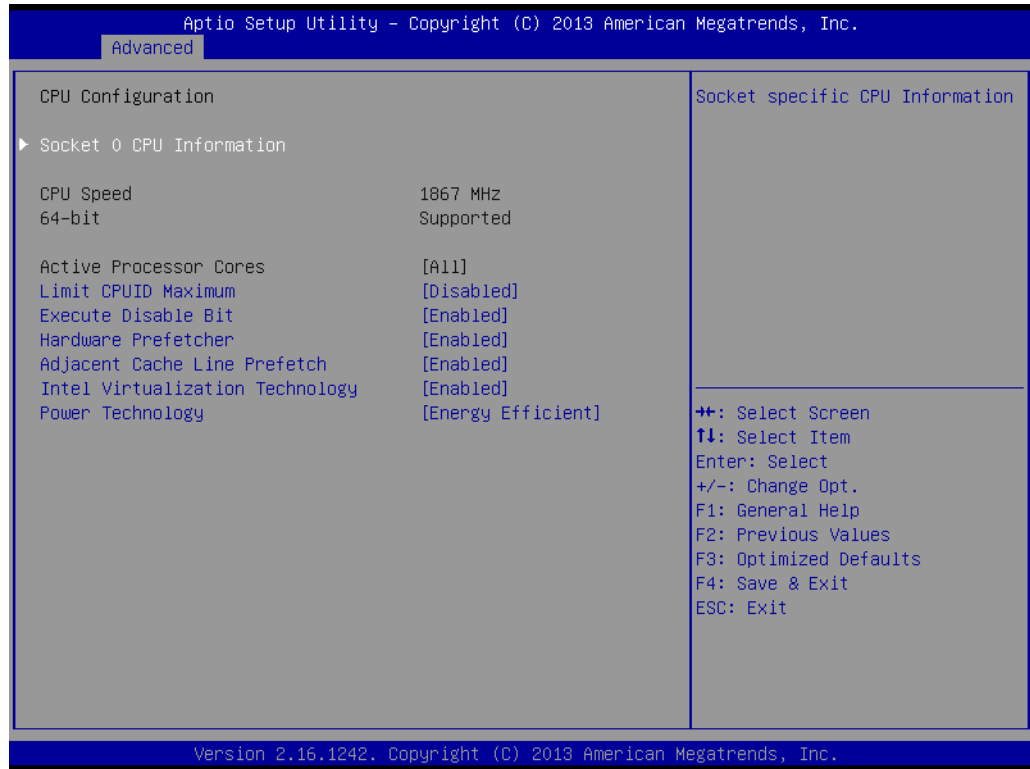

Figure 3.6 CPU configuration setup screen

- **PPM Configuration**
Enable/disable CPU C state report to OS

■ IDE Configuration

Allows users to adjust the IDE device configuration

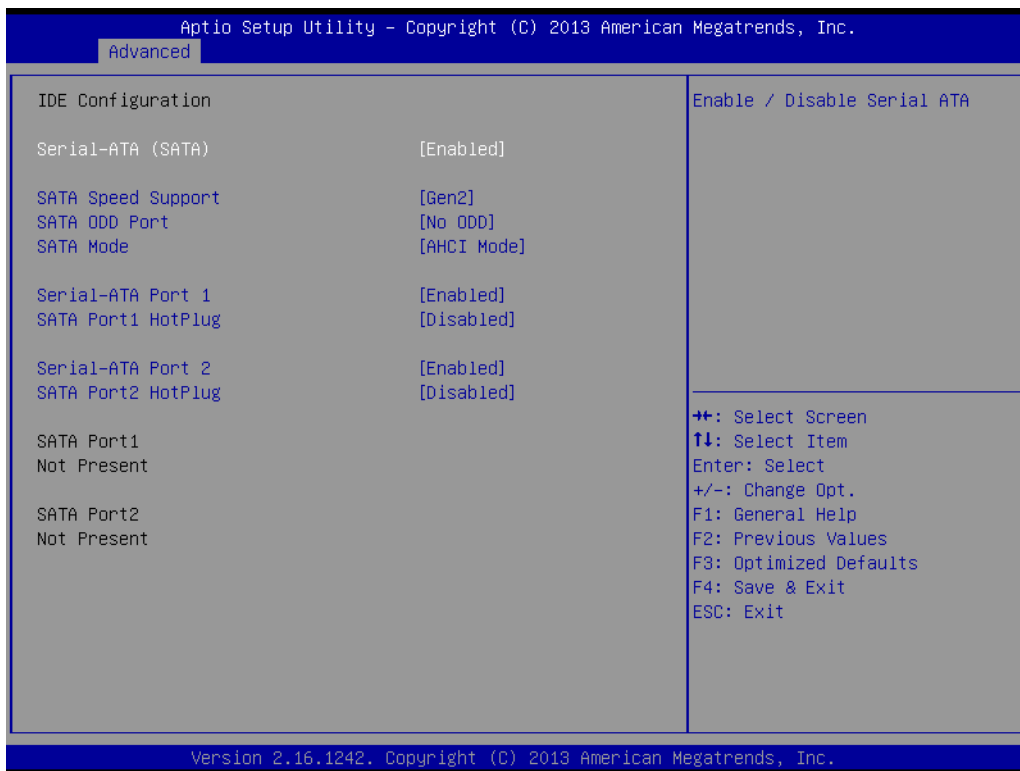

Figure 3.7 IDE configuration setup screen

■ Miscellaneous Configuration

Enable/disable miscellaneous features

– High Precision Timer

Enable/disable the high precision event timer

– PCI Express Dynamic Clock Gating

Enable/disable PCIe dynamic clock gating

– OS Selection

Allows users to select the OS. The selected OS should be specified and employed.

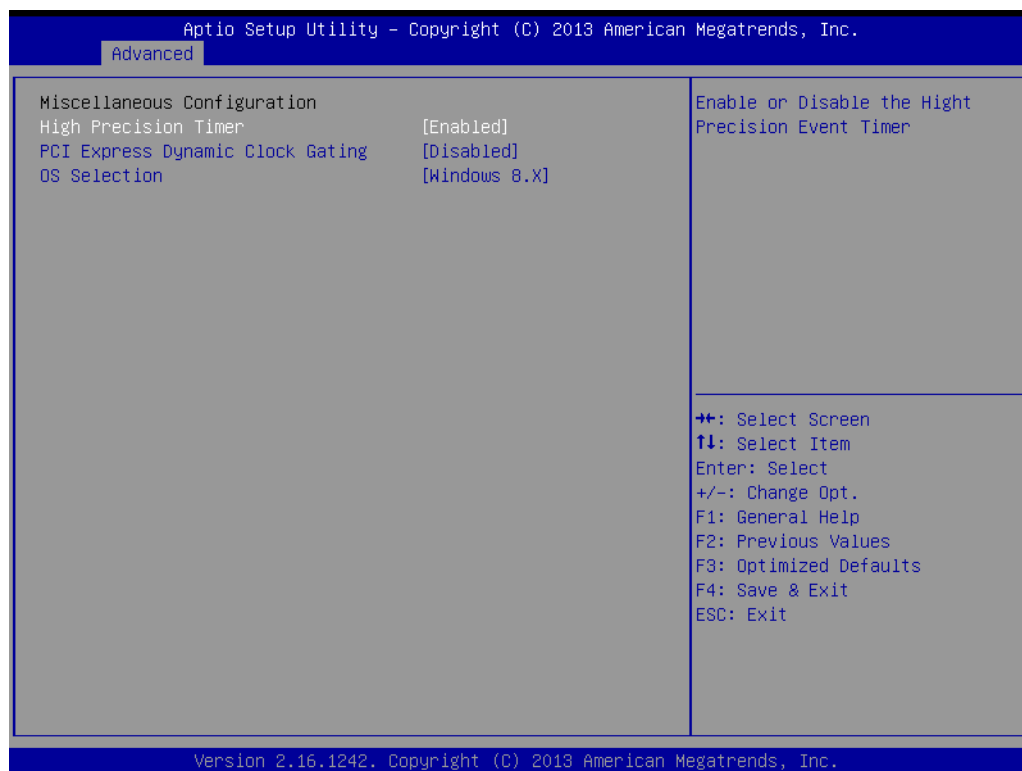

Figure 3.8 Miscellaneous Configuration setup screen

- **CSM Configuration**
Enable/disable Option ROM execution
- **USB Configuration**
Allows users to adjust the USB configuration
 - **Legacy USB Support**
Enable/disable legacy USB support. The AUTO option disables legacy support if no USB devices are connected. The DISABLE option renders USB devices only available for EFI applications.
 - **XHCI Hand-Off**
This is a workaround for OS without XHCI hand-off support. The XHCI ownership change should be claimed by the XHCI driver.
 - **EHCI Hand-Off**
This is a workaround for OS without EHCI hand-off support. The EHCI ownership change should be claimed by the EHCI driver.
 - **USB Mass Storage Driver Support**
Enable/disable USB mass storage driver support
 - **USB Transfer Timeout**
Allows users to specify the timeout value for Control, Bulk, and Interrupt transfers. The value options available are 1, 5, 10, and 20 seconds.
 - **Device Reset Timeout**
Allows users to specify the USB mass storage device Start Unit Command timeout value. The value options available are 10, 20, 30, and 40 seconds.
 - **Device Power-Up Delay**
Allows auto/manual configuration of the USB mass storage device Start Unit Command timeout value.



Figure 3.9 USB Configuration setup screen

- **Security Configuration**
Intel® Anti-Theft Technology configuration

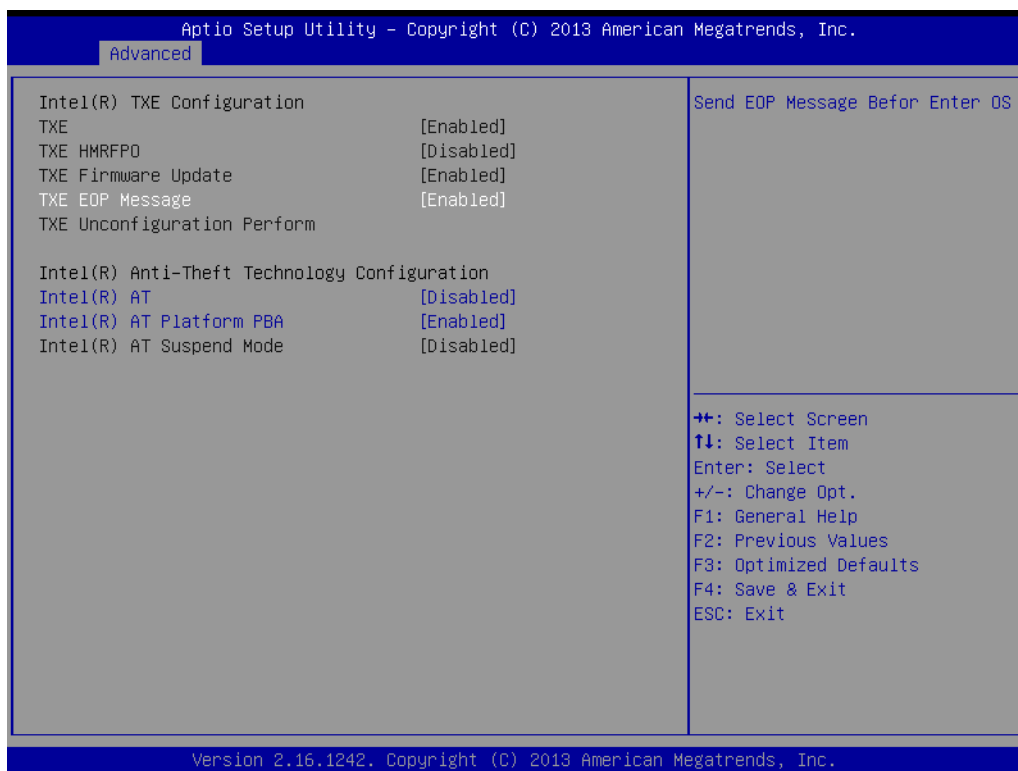

Figure 3.10 Intel® TXE Configuration setup screen

3.2.3 Chipset BIOS Feature Setup

Select the Chipset tab in the DS-570 BIOS Setup Utility to enter the Chipset BIOS setup screen. Users can select any item displayed in the left frame.

- **North Bridge**
 - North Bridge parameters
 - **Memory Information**
 - Max TOLUD: Maximum value of TOLUD
- **South Bridge**
 - South Bridge parameters
 - **Azalia HD Audio**
 - Azalia HD audio options
 - **USB Configuration**
 - USB Configuration settings
 - **XHCI Mode**
 - Enable/disable the XHCI controller
 - **USB2 Link Power Management**
 - Enable/disable USB2 link power management
 - **PCI Express Configuration**
 - PCI Express Configuration settings
 - **LAN1 Control**
 - Enable/disable LAN1
 - **LAN2 Control**
 - Enable/disable LAN2
 - **PXE OpROM**
 - Controls .exe files
 - **Launch PXE OpROM**
 - Enable/disable boot options for legacy network devices
 - **PCIe Wake**
 - Enable/disable system wake from S5 via PCIe
 - **Restore AC Power Loss**
 - Select AC power state when power is re-applied after a power failure
 - **Global SMI Lock**
 - Enable/disable SMI lock
 - **BIOS Read/Write Protection**
 - Enable/disable BIOS SPI region read/write protection

3.2.4 Security BIOS Feature Setup

Select the Security tab in the DS-570 BIOS Setup Utility to enter the Security BIOS setup screen.

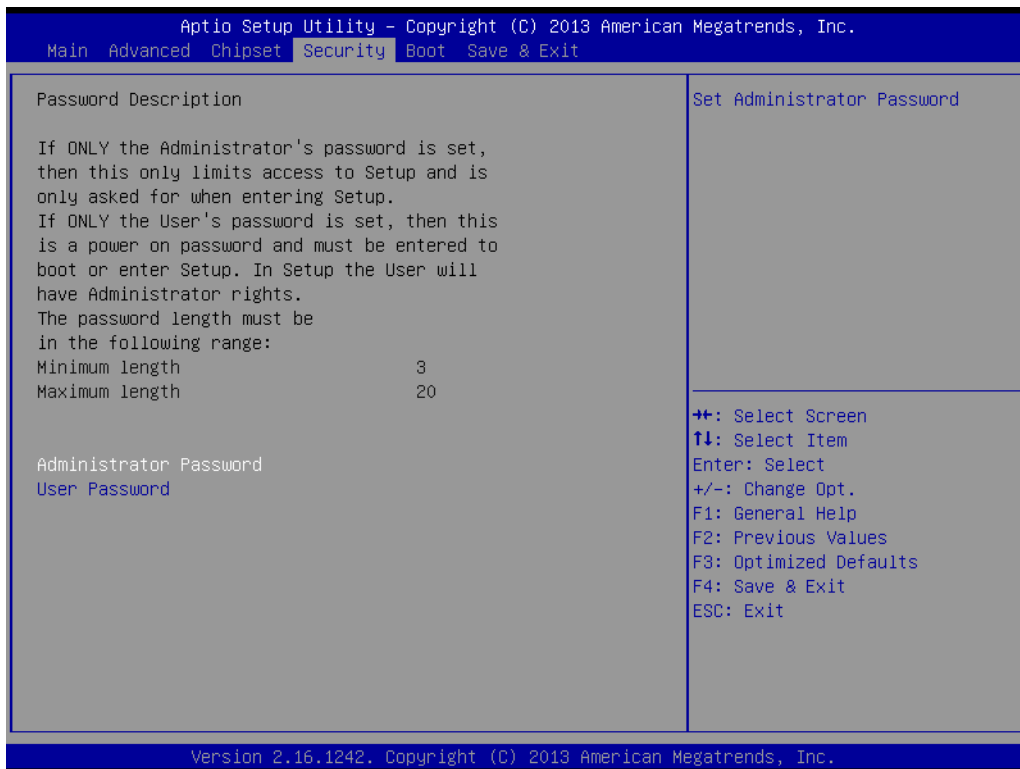

Figure 3.11 Security Configuration setup screen

- **Administrator Password**
Allows users to set the administrator password
- **User Password**
Allows users to set the user password

3.2.5 Boot BIOS Feature Setup

Select the Boot tab in the DS-570 BIOS Setup Utility to enter the Boot BIOS setup screen. Users can select any item displayed in the left frame.

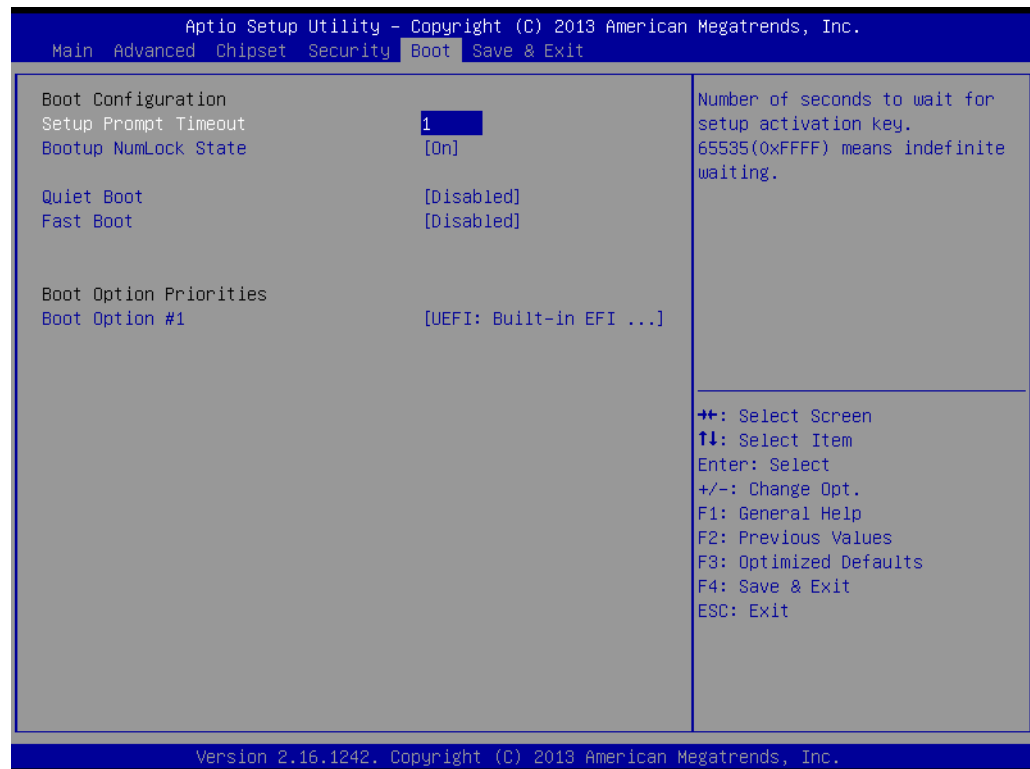

Figure 3.12 Boot Configuration setup screen

- **Setup Prompt Timeout**
Allows users to specify the number of seconds to wait for a setup activation key. “65535 (0xFFFF)” means wait indefinitely.
- **Bootup NumLock State**
Allows users to select the keyboard NumLock state
- **Quiet Boot**
Enable/disable Quiet Boot option
- **Fast Boot**
Enable/disable system boot with only the devices required to launch an active boot option initialized. Does not affect BBS boot options.
- **Boot Option #1**
Allows users to specify the system boot order

3.2.6 Save & Exit BIOS Feature Setup

Select the Save & Exit tab in DS-570 BIOS Setup Utility to enter the Save & Exit BIOS setup screen.

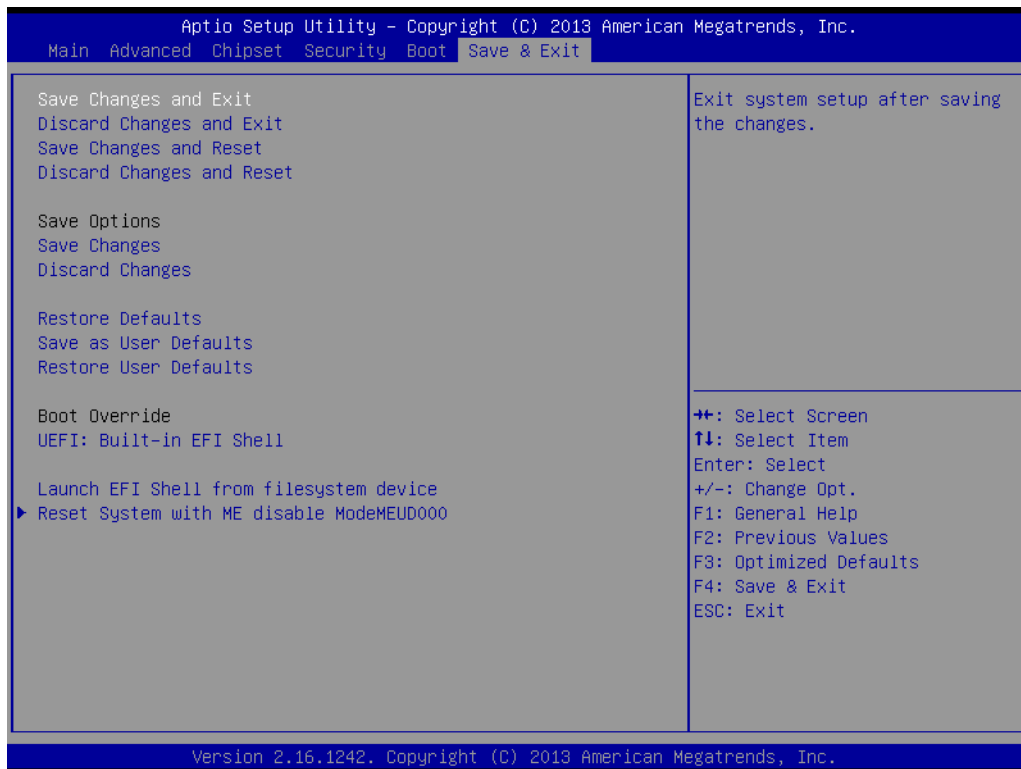

Figure 3.13 Save & Exit Configuration setup screen

- **Save Changes and Exit**
Exit system setup after saving changes
- **Discard Changes and Exit**
Exit system setup without saving changes
- **Save Changes and Reset**
Reset the system after saving changes
- **Discard Changes and Reset**
Reset the system without saving changes
- **Save Changes**
Save all changes to the setup options
- **Discard Changes**
Discard all changes to the setup options
- **Restore Defaults**
Restore/load default values for all setup options
- **Save as User Defaults**
Save changes as User Defaults
- **Restore User Defaults**
Restore User Defaults for all setup options
- **Boot Override**
 - **UEFI**
Built-in EFI Shell
 - **Launch EFI Shell From File System Device**

Allows users to launch the EFI Shell application (Shell.efi) from an available file system device

- **Reset System With ME Disable Mode MEUD000**

ME will execute the temporary disable mode, or ignore if ME ignition is FWMED001

Chapter 4

Software

This chapter explains the OS installation prompts.

4.1 Intel® TXE Driver Installation

For Windows 7, the Windows update KB2685811 must be installed before TXE driver installation.

Notice: For more information about KB2685811, please download the relevant update information from the official Microsoft website, or access the following link:

<http://www.microsoft.com/en-us/download/details.aspx?id=38423>

Note



- We strongly recommend using the FITC tool provided with this kit.
- Please ensure to use Intel® TXE FW and system tools from the same kit. Combining different versions may cause unexpected issues.
- Please use the SPI Flash parts that adhere to the specifications outlined in the Bay Trail Platform SoC SPI Flash Compatibility Requirements document (IBL# 514482, Section 3)
- Please note that the Intel® TXE driver for Android OS is provided as part of the Android-based UEFI BIOS OS image.
- The FPT, TXE Info, and TXE manufacturing tools do not support Windows* 7. Users are required to run TXE manufacturing tools in an EFI Shell or WinPE environment.
- Regarding the Windows® 7 OS: The Intel® TXE driver uses KMDF (WDF) 1.11, which is built into Windows® 8 and 8.1. However, Windows® 7 is not equipped with this driver. Users should install the Kernel-Mode Driver Framework (KMDF), Version 1.1. Otherwise, a yellow bang will appear on the Intel® TXE device following installation. Please adhere to the instructions provided in the following link: <http://www.microsoft.com/en-us/download/details.aspx?id=38423>
- The Sample Signer reference code does not provide adequate security. Users must add substantial functionalities and modify the software to protect their private key. Intel assumes no liability for lost or stolen private key data and/or systems, nor for any other damage resulting thereof.
- The VCN value has been increased to "8". Consequently, a full FW upgrade from Intel® TXE FW 1.1.0.1089 is possible; however, a downgrade from Intel® TXE FW 1.1.0.1113 to an earlier kit is not possible.

Caution! Before OS installation, the selected OS should be specified and match the OS employed by the BIOS (refer to Figure 3.8).



ADVANTECH

Enabling an Intelligent Planet

www.advantech.com

Please verify specifications before quoting. This guide is intended for reference purposes only.

All product specifications are subject to change without notice.

No part of this publication may be reproduced in any form or by any means, such as electronically, by photocopying, recording, or otherwise, without the prior written permission of the publisher.

All brand and product names are trademarks or registered trademarks of their respective companies.

© Advantech Co., Ltd. 2014