

LuxiGen Multi-Color Emitter Series  
LZP RGBW Flat Lens LED Emitter

# LZP-04MD00

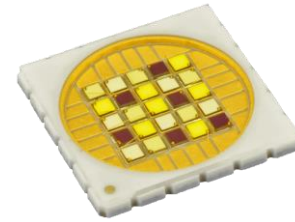

## Key Features

- Highest flux density surface mount ceramic package RGBW LED with integrated flat glass lens
- 6.2mmx6.2mm Light Emitting Area with 80W power dissipation
- Ideal for narrow beam applications of less than 10° and light guide coupling
- Industry lowest thermal resistance per package footprint (0.5°C/W)
- Individually addressable Red, Green, Blue and Daylight White channels
- In-source mixing based on smart die positioning for optimum color uniformity
- Electrically neutral thermal path
- JEDEC Level 1 for Moisture Sensitivity Level
- Lead (Pb) free and RoHS compliant
- Emitter available on 4-channel MCPCB (optional)

## Typical Applications

- Stage and Studio lighting
- Fountain lighting
- Accent lighting
- Effect lighting

## Description

The 80W LZP-04MD00 RGBW LED emitter produces a full spectrum of brilliant colors with the highest flux density from a compact 6.2mmx6.2mm Light Emitting Area. Through its small size and ultra-low thermal resistance, it enables the miniaturization of lighting fixtures with individual red, green, blue and white LED emitters. Utilizing a flat glass lens minimizes the étendue going into secondary optics, facilitating the use of zoom optics, mixing rods, light pipes and other optics to produce narrow beams of less than 10°. The emitter's smart die positioning pre-mixes the colors before going into secondary optics further maximizing coupling efficiency. The high quality materials used in the package are chosen to optimize light output and minimize stresses which results in monumental reliability and lumen maintenance. The robust product design thrives in outdoor applications with high ambient temperatures and high humidity.

## Part Number Options

### Base part number

Part number	Description
LZP-04MD00-xxxx	LZP RGBW flat lens emitter
LZP-L4MD00-xxxx	LZP RGBW flat lens emitter on 4 channel Star MCPCB

### Bin kit option codes:

MD, Red-Green-Blue-White (6500K)			
Kit number suffix	Min flux Bin	Color Bin Ranges	Description
0000	20R	R01	Red, full distribution flux; full distribution wavelength
	22G	G2 – G3	Green, full distribution flux; full distribution wavelength
	23B	B03	Blue, full distribution flux; full distribution wavelength
	10W	W65	White full distribution flux and CCT

## Daylight White Chromaticity Groups

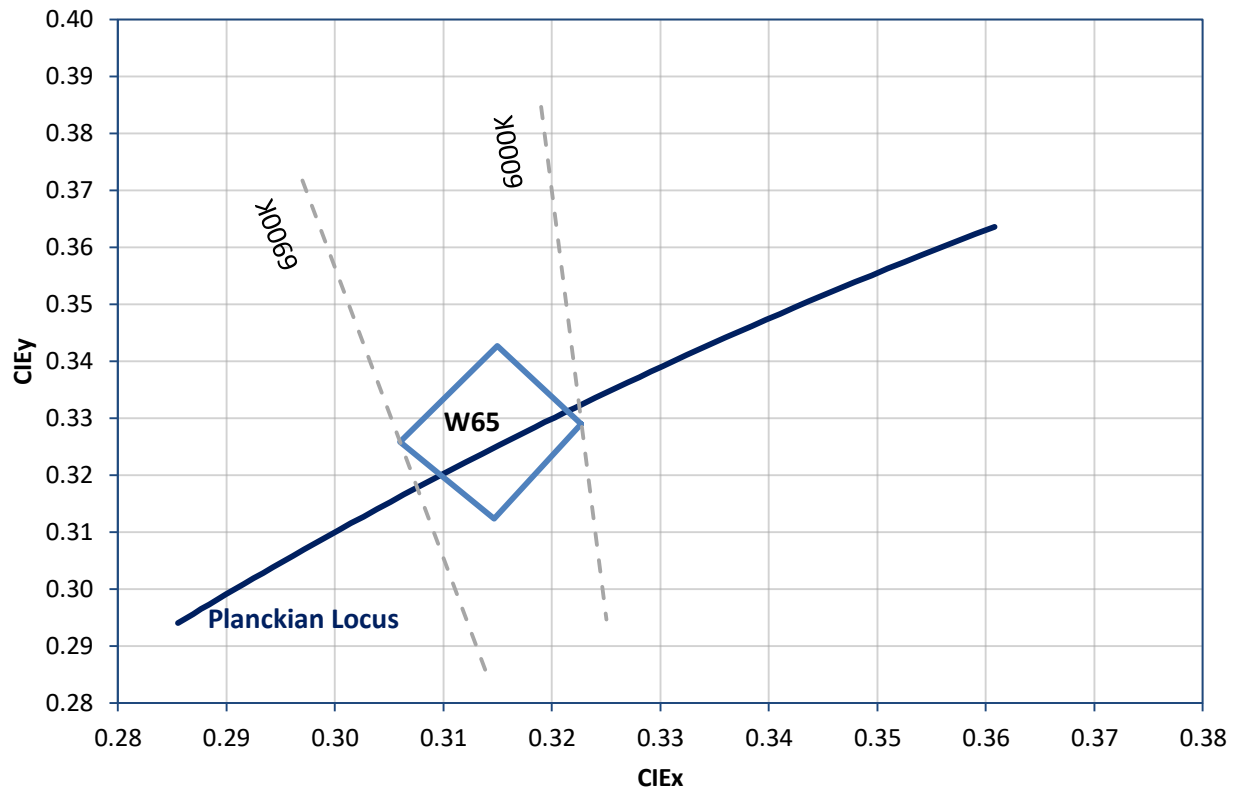

Standard Chromaticity Groups plotted on excerpt from the CIE 1931 (2°) x-y Chromaticity Diagram. Coordinates are listed below.

## Daylight White Bin Coordinates

Bin Code	CIE <sub>x</sub>	CIE <sub>y</sub>
W65	0.3227	0.329
	0.315	0.3427
	0.306	0.3258
	0.3147	0.3123
	0.3227	0.329

## Luminous Flux Bins

Table 1:

Bin Code	Minimum Luminous Flux ( $\Phi_v$ ) @ $I_F = 700\text{mA}^{[1]}$ (lm)				Maximum Luminous Flux ( $\Phi_v$ ) @ $I_F = 700\text{mA}^{[1]}$ (lm)			
	6 Red	6 Green	6 Blue	7 White	6 Red	6 Green	6 Blue	7 White
	20R	360				625		
22G		600				1000		
23B			130				210	
10W				1120				1785

Notes for Table 1:

- Luminous flux performance is measured at 10ms pulse,  $T_c = 25^\circ\text{C}$ ; with all LED dice with the same color connected in series. LED Engin maintains a tolerance of  $\pm 10\%$  on flux measurements.

## Dominant Wavelength Bins

Table 2:

Bin Code	Minimum Dominant Wavelength ( $\lambda_D$ ) @ $I_F = 700\text{mA}^{[1]}$ (nm)			Maximum Dominant Wavelength ( $\lambda_D$ ) @ $I_F = 700\text{mA}^{[1]}$ (nm)		
	Red	Green	Blue	Red	Green	Blue
	R01	617			630	
G2		520			525	
G3		525			530	
B03			453			460

Notes for Table 2:

- Dominant wavelength is measured at 10ms pulse,  $T_c = 25^\circ\text{C}$ . LED Engin maintains a tolerance of  $\pm 1.0\text{nm}$  on dominant wavelength measurements.

## Forward Voltage Bin

Table 3:

Bin Code	Minimum Forward Voltage ( $V_F$ ) @ $I_F = 700\text{mA}^{[1]}$ (V)				Maximum Forward Voltage ( $V_F$ ) @ $I_F = 700\text{mA}^{[1]}$ (V)			
	6 Red	6 Green	6 Blue	7 White	6 Red	6 Green	6 Blue	7 White
	0	12.6	19.2	16.8	19.6	17.4	25.2	22.8

Notes for Table 3:

- Forward Voltage is measured at 10ms pulse,  $T_c = 25^\circ\text{C}$ ; with all LED dice with the same color connected in series.
- LED Engin maintains a tolerance of  $\pm 0.24\text{V}$  for forward voltage measurements for 6 LEDs and  $\pm 0.28\text{V}$  for 7 LEDs.

## Absolute Maximum Ratings

Table 4:

Parameter	Symbol	Value	Unit
DC Forward Current <sup>[1]</sup>	$I_F$	1000	mA
Peak Pulsed Forward Current <sup>[2]</sup>	$I_{FP}$	1500	mA
Reverse Voltage	$V_R$	See Note 3	V
Storage Temperature	$T_{stg}$	-40 ~ +150	°C
Junction Temperature [Blue, Green, White]	$T_J$	150	°C
Junction Temperature [Red]	$T_J$	125	°C
Soldering Temperature <sup>[4]</sup>	$T_{sol}$	260	°C

Notes for Table 4:

- Maximum DC forward current is determined by the overall thermal resistance and ambient temperature. Follow the curves in Figure 11 for current derating.
- Pulse forward current conditions: Pulse Width  $\leq$  10msec and Duty Cycle  $\leq$  10%.
- LEDs are not designed to be reverse biased.
- Solder conditions per JEDEC 020D. See Reflow Soldering Profile Figure 5.
- LED Engin recommends taking reasonable precautions towards possible ESD damages and handling the LZP-04MD00 in an electrostatic protected area (EPA). An EPA may be adequately protected by ESD controls as outlined in ANSI/ESD S6.1.

## Optical Characteristics @ $T_C = 25^\circ\text{C}$

Table 5:

Parameter	Symbol	Typical				Unit
		6 Red	6 Green	6 Blue <sup>[1]</sup>	7 White	
Luminous Flux (@ $I_F = 700\text{mA}$ )	$\Phi_V$	460	820	190	1400	lm
Luminous Flux (@ $I_F = 1000\text{mA}$ )	$\Phi_V$	640	1060	245	1800	lm
Dominant Wavelength	$\lambda_D$	623	523	457		nm
Correlated Color Temperature	CCT				6500	K
Color Rendering Index (CRI)	$R_a$				75	
Viewing Angle <sup>[2]</sup>	$2\Theta_{\frac{1}{2}}$		120			Degrees
Total Included Angle <sup>[3]</sup>	$\Theta_{0.9}$		160			Degrees

Notes for Table 5:

- When operating the Blue LED, observe IEC 62471 Risk Group 2 rating. Do not stare into the beam.
- Viewing Angle is the off axis angle from emitter centerline where the luminous intensity is  $\frac{1}{2}$  of the peak value.
- Total Included Angle is the total angle that includes 90% of the total luminous flux.

## Electrical Characteristics @ $T_C = 25^\circ\text{C}$

Table 6:

Parameter	Symbol	Typical				Unit
		6 Red	6 Green	6 Blue	7 White	
Forward Voltage (@ $I_F = 700\text{mA}$ ) <sup>[1]</sup>	$V_F$	15.0	21.6	19.2	22.4	V
Forward Voltage (@ $I_F = 1000\text{mA}$ ) <sup>[1]</sup>	$V_F$	16.2	22.4	19.9	23.3	V
Temperature Coefficient of Forward Voltage	$\Delta V_F / \Delta T_J$	-13.3	-17.4	-12.0	-12.0	mV/°C
Thermal Resistance (Junction to Case)	$R\Theta_{J-C}$		0.5			°C/W

Notes for Table 6:

- Forward Voltage typical value is for all LED dice from the same color dice connected in series.

## IPC/JEDEC Moisture Sensitivity Level

Table 7 - IPC/JEDEC J-STD-020 MSL Classification:

Level	Soak Requirements					
	Floor Life		Standard		Accelerated	
	Time	Conditions	Time (hrs)	Conditions	Time (hrs)	Conditions
1	unlimited	≤ 30°C/ 60% RH	168 +5/-0	85°C/ 60% RH	n/a	n/a

Notes for Table 7:

1. The standard soak time includes a default value of 24 hours for semiconductor manufacturer's exposure time (MET) between bake and bag and includes the maximum time allowed out of the bag at the distributor's facility.

## Average Lumen Maintenance Projections

Lumen maintenance generally describes the ability of a lamp to retain its output over time. The useful lifetime for solid state lighting devices (Power LEDs) is also defined as Lumen Maintenance, with the percentage of the original light output remaining at a defined time period.

Based on long-term HTOL testing, LED Engin projects that the LZP Series will deliver, on average, above 70% Lumen Maintenance at 20,000 hours of operation at a forward current of 700mA. This projection is based on constant current operation with junction temperature maintained at or below 120°C for LZP product.







## Reflow Soldering Profile

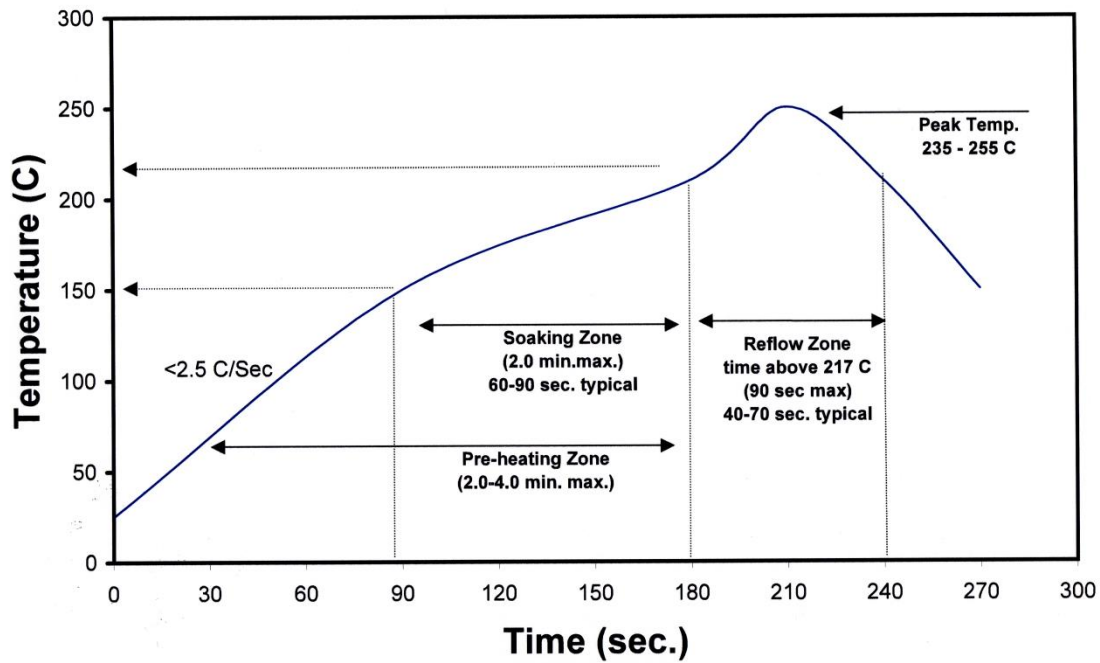

Figure 3: Reflow soldering profile for lead free soldering.

## Typical Radiation Pattern

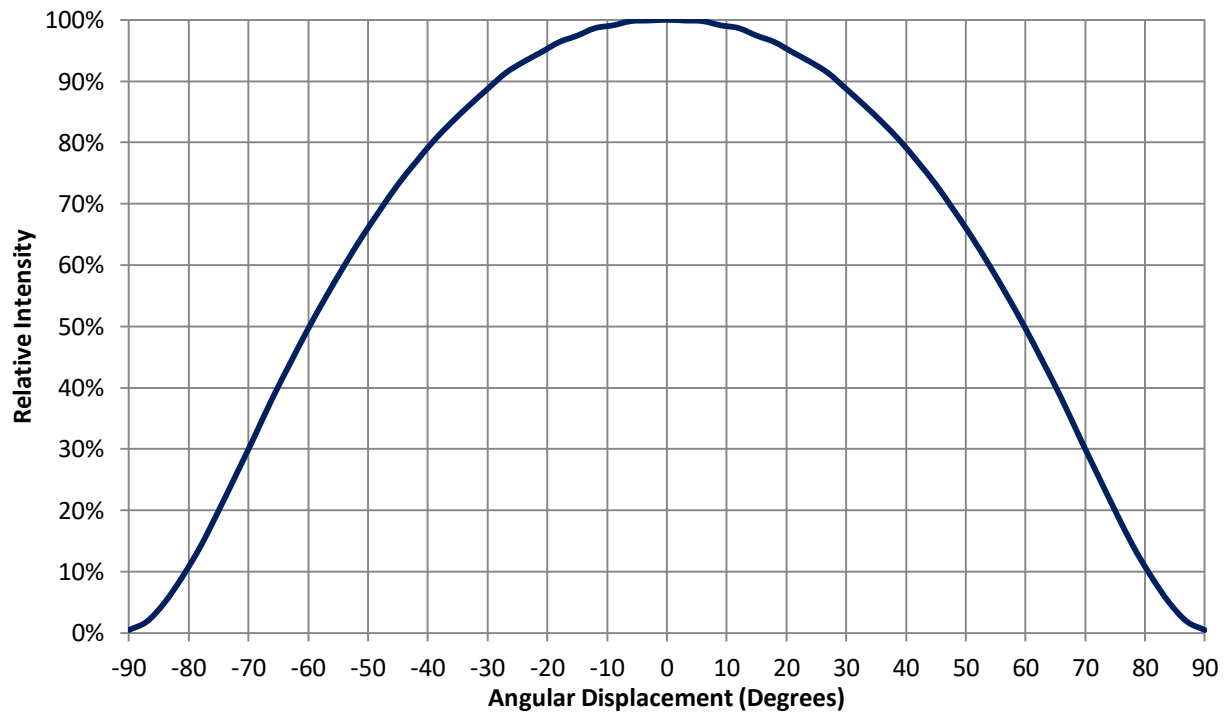

Figure 4: Typical representative spatial radiation pattern.

### Typical Relative Spectral Power Distribution

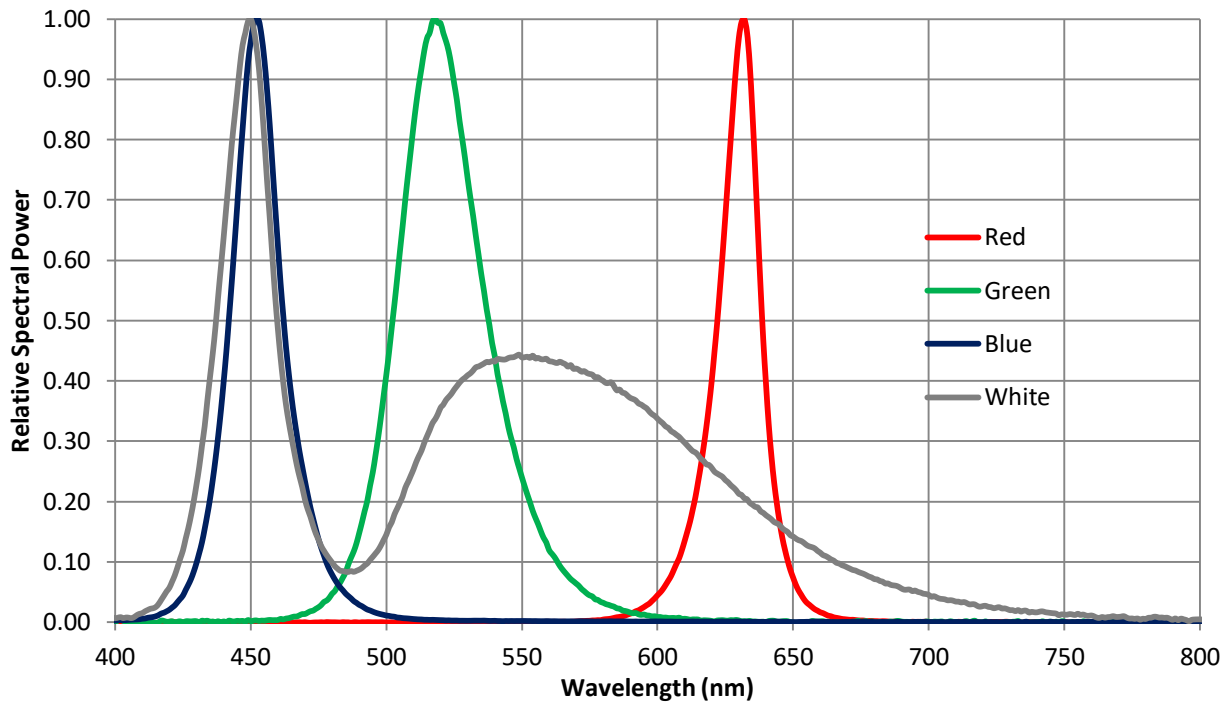

Figure 5: Typical relative spectral power vs. wavelength @ T<sub>c</sub> = 25°C.

### Typical Forward Current Characteristics

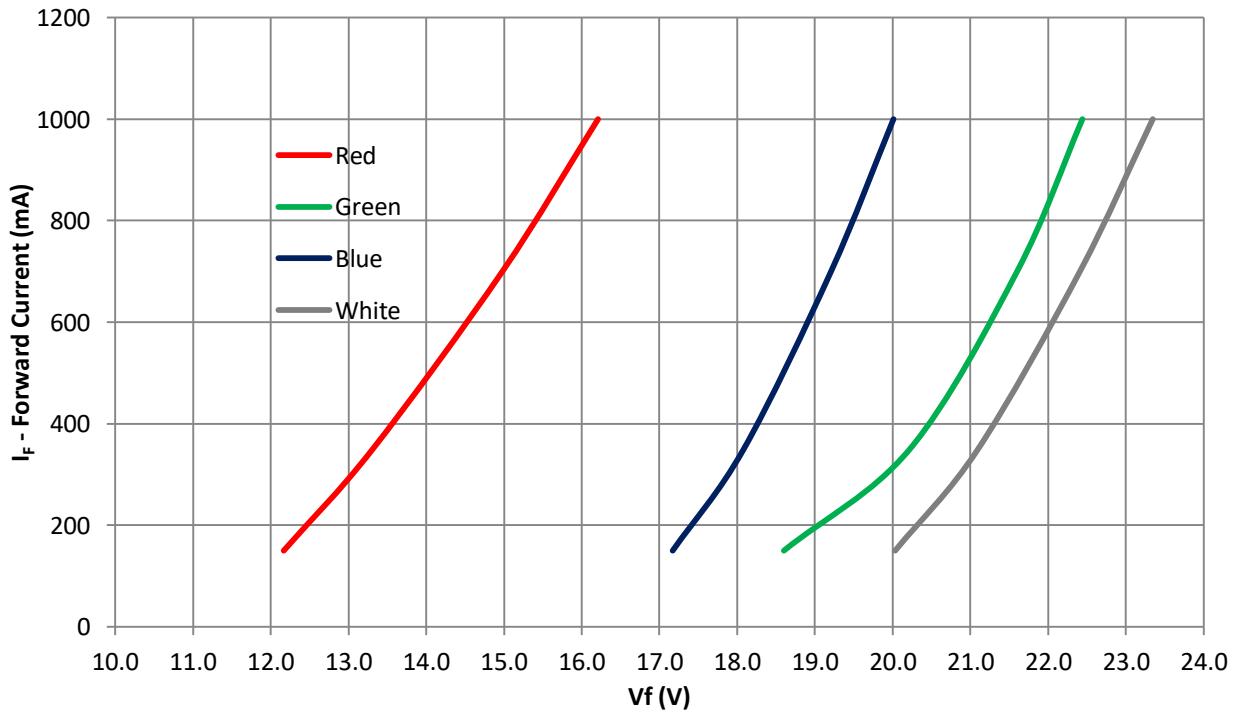

Figure 6: Typical forward current vs. forward voltage @ T<sub>c</sub> = 25°C

### Typical Relative Light Output over Current

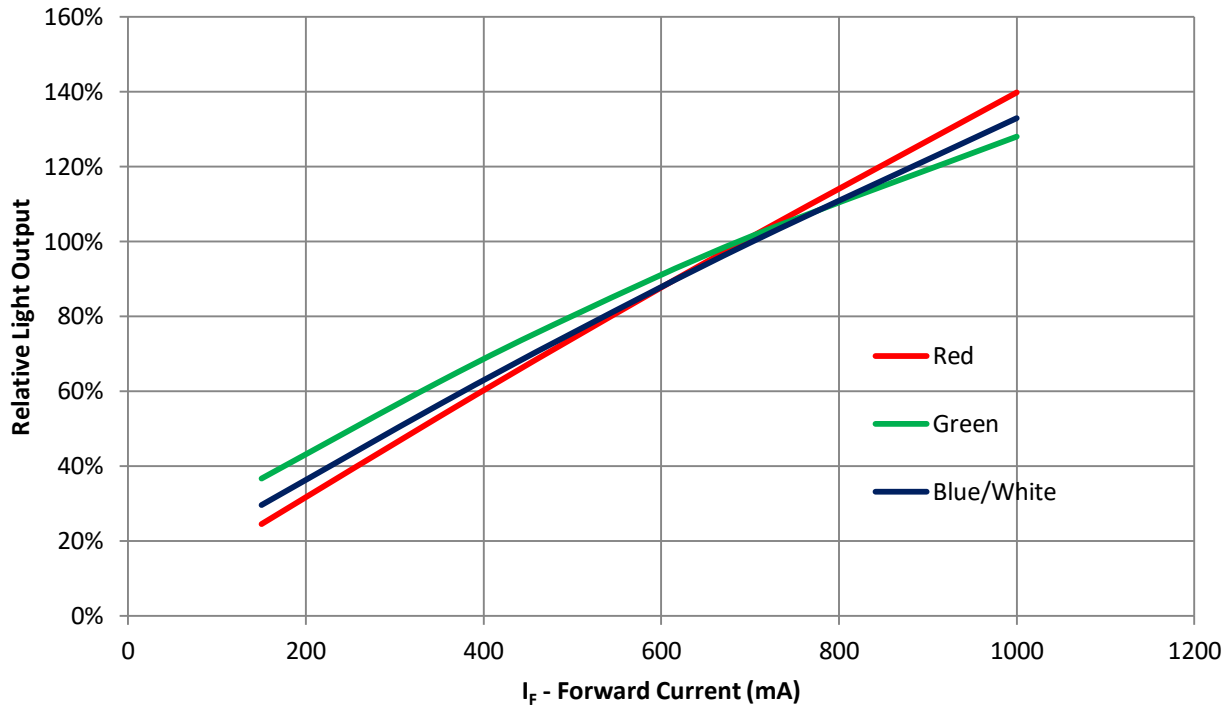

Figure 7: Typical relative light output vs. forward current @ T<sub>c</sub> = 25°C

### Typical Relative Light Output over Temperature

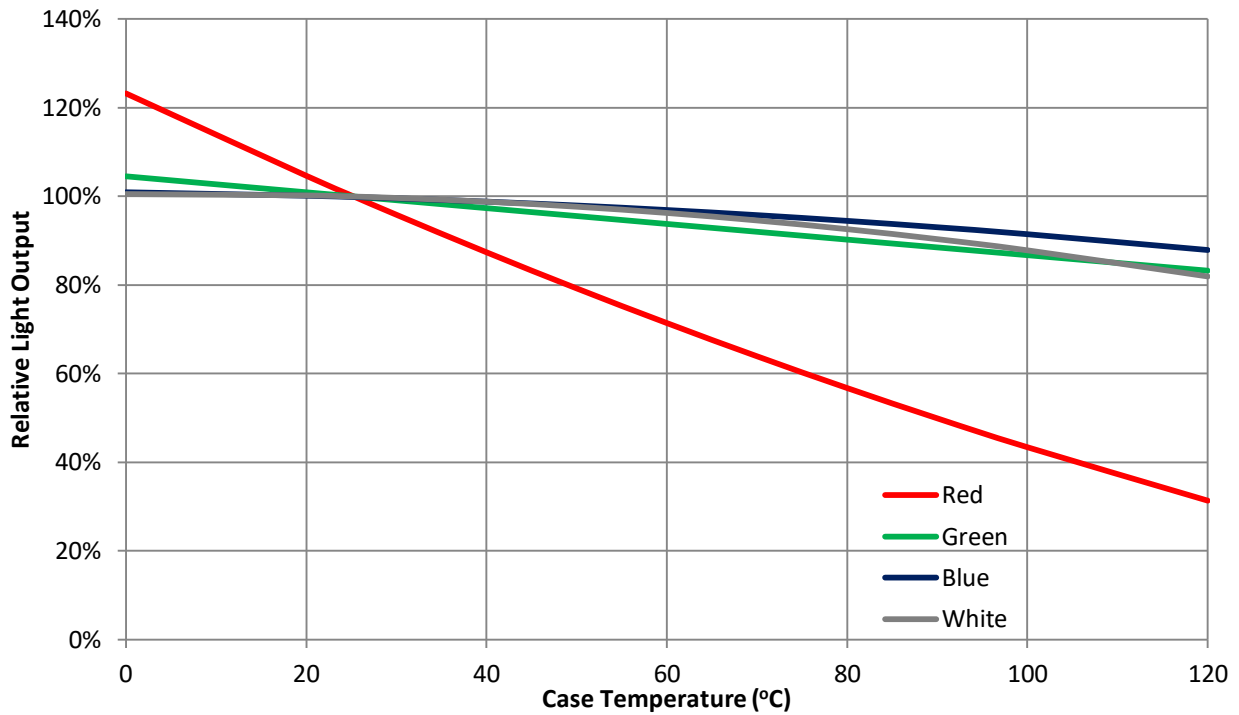

Figure 8: Typical relative light output vs. case temperature.

Typical Dominant Wavelength/Chromaticity Coordinate Shift over Current

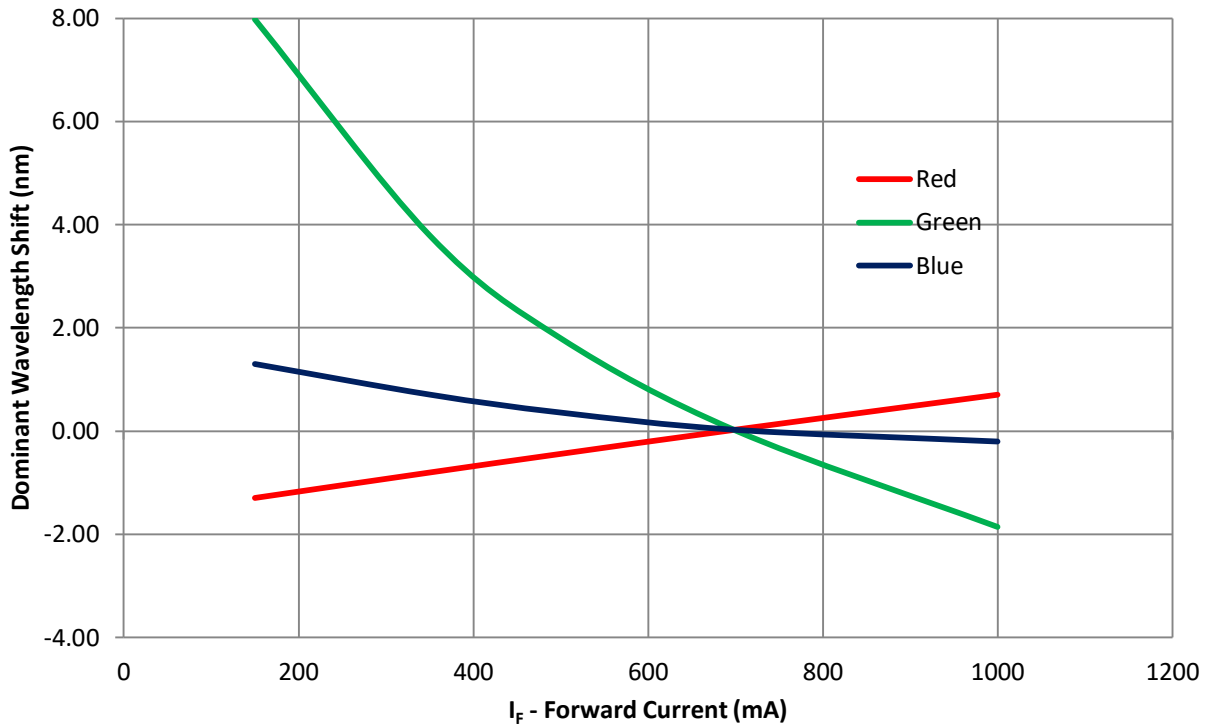

Figure 9a: Typical dominant wavelength shift vs. forward current @  $T_c = 25^\circ\text{C}$ .

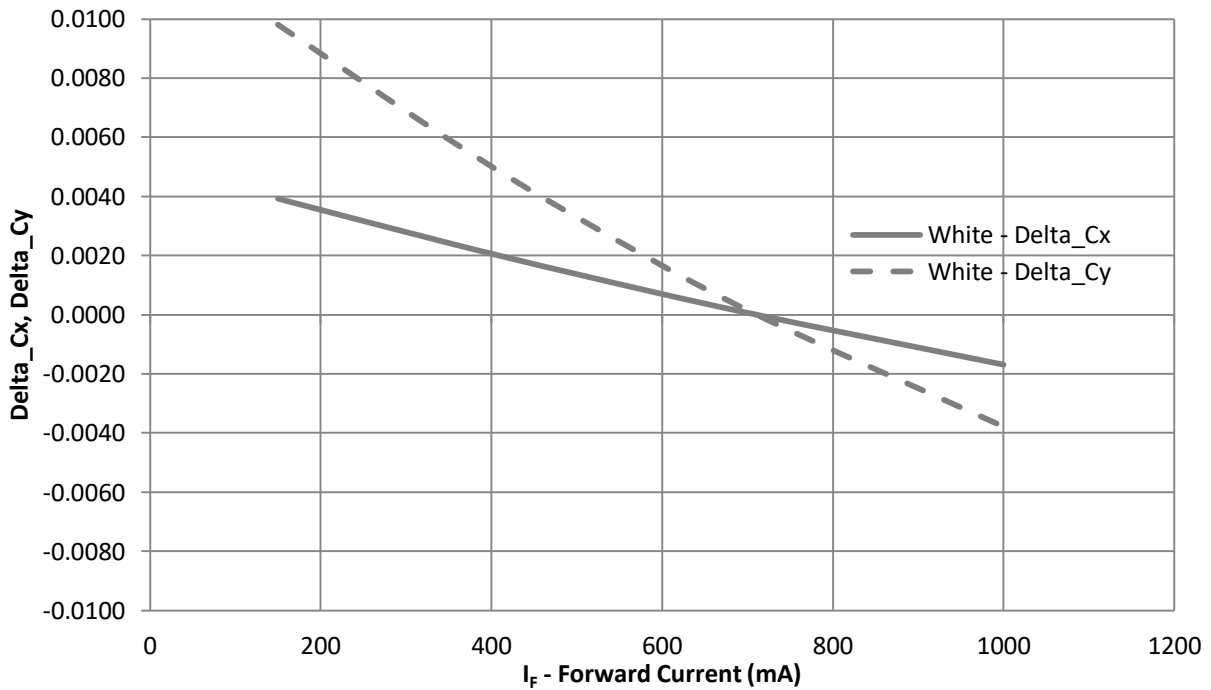

Figure 9b: Typical chromaticity coordinate shift vs. forward current @  $T_c = 25^\circ\text{C}$ .

### Typical Dominant Wavelength/Chromaticity Coordinate Shift over Temperature

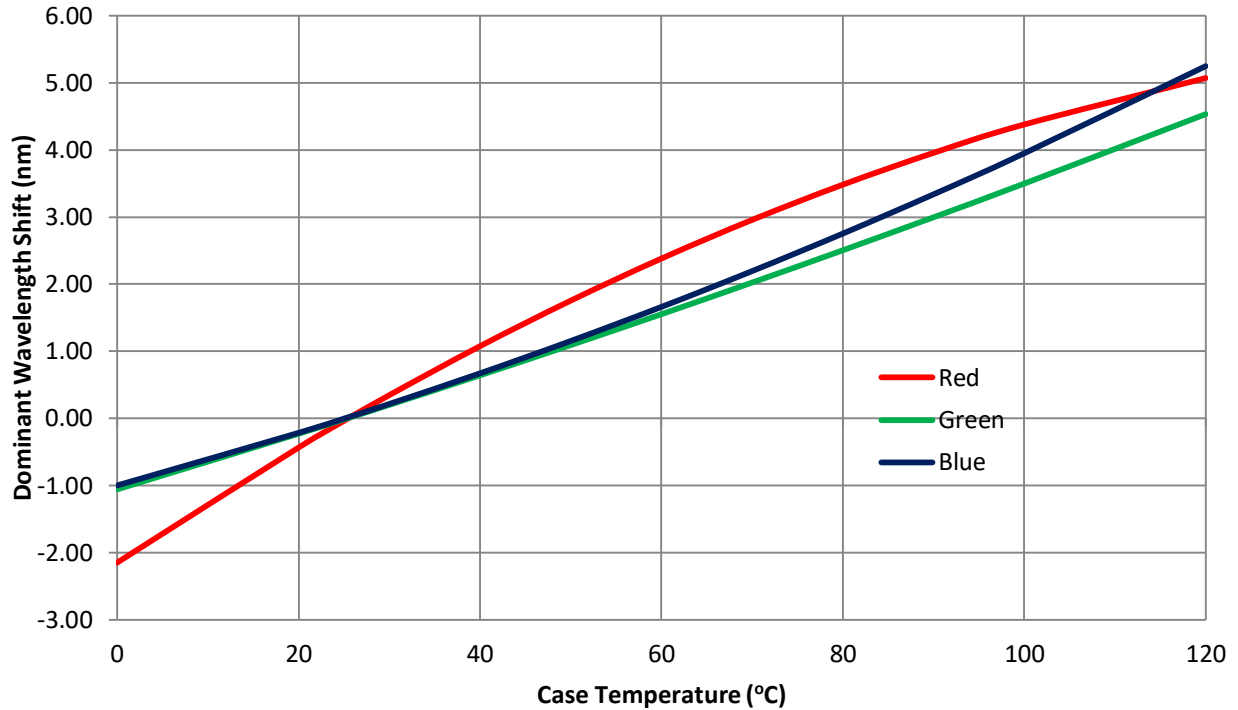

Figure 10a: Typical dominant wavelength shift vs. case temperature

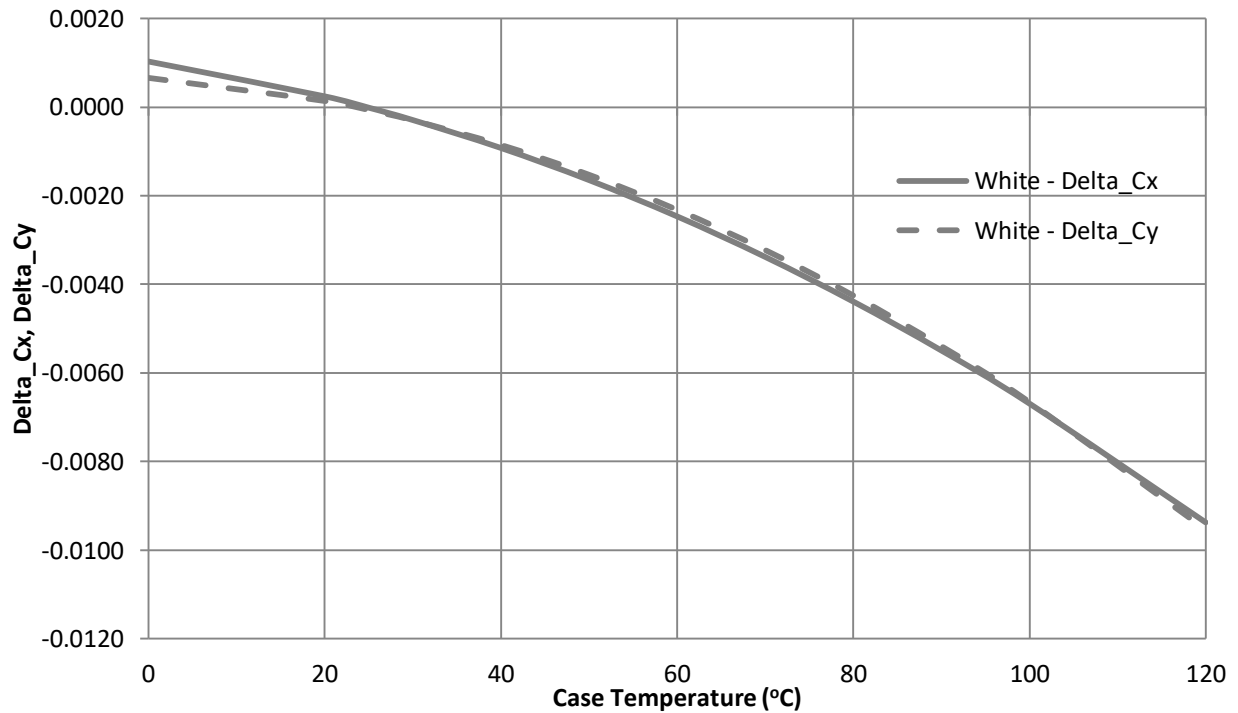

Figure 10b: Typical chromaticity coordinate shift vs. case temperature

## Current De-rating

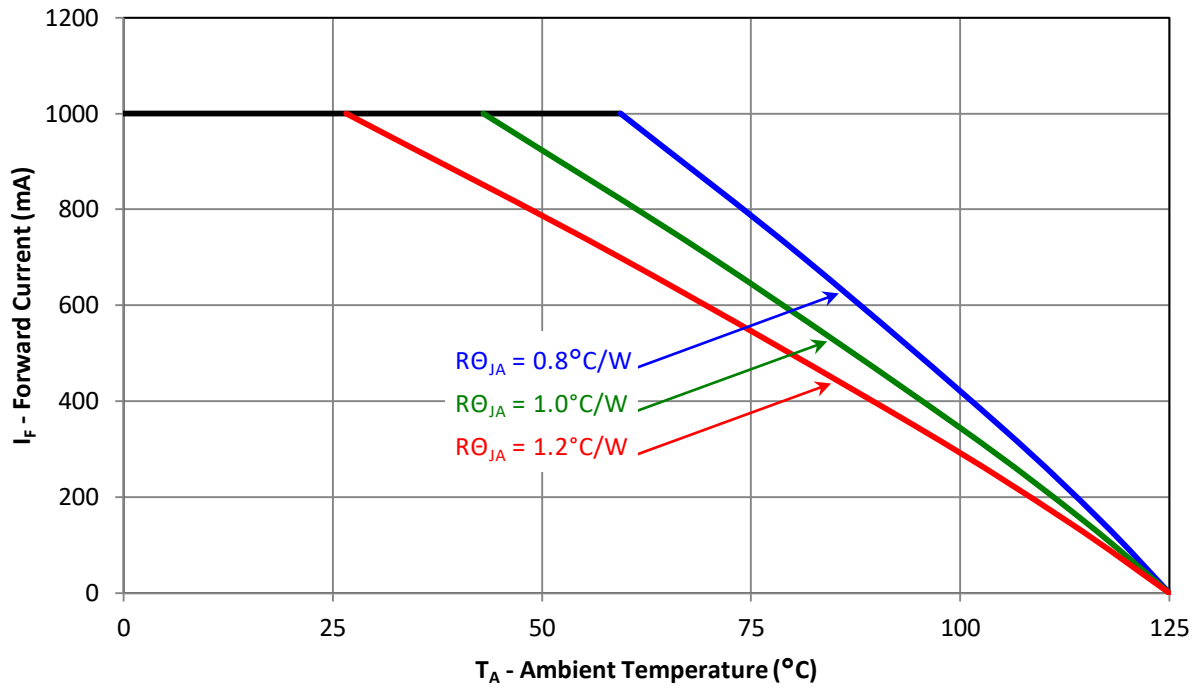

Figure 11: Maximum forward current vs. ambient temperature based on  $T_{J(\text{MAX})} = 125^\circ\text{C}$

Notes for Figure 11:

1. Maximum current assumes that all 25 LED dice are operating concurrently at the same current.
2.  $R_{\theta JC}$  [Junction to Case Thermal Resistance] for LZP-04MD00 is typically  $0.5^\circ\text{C/W}$ .
3.  $R_{\theta JA}$  [Junction to Ambient Thermal Resistance] =  $R_{\theta JC} + R_{\theta CA}$  [Case to Ambient Thermal Resistance].

# LZP MCPCB Family

Part number	Type of MCPCB	Diameter (mm)	Emitter + MCPCB Thermal Resistance (°C/W)	Typical V <sub>F</sub> (V)	Typical I <sub>F</sub> (mA)
LZP-Lxxxxx	4-channel	28.3	0.5 + 0.1 = 0.6	15.0 - 22.4	4 x 700

# LZP-Lxxxxx

## 4-Channel MCPCB Mechanical Dimensions (mm)

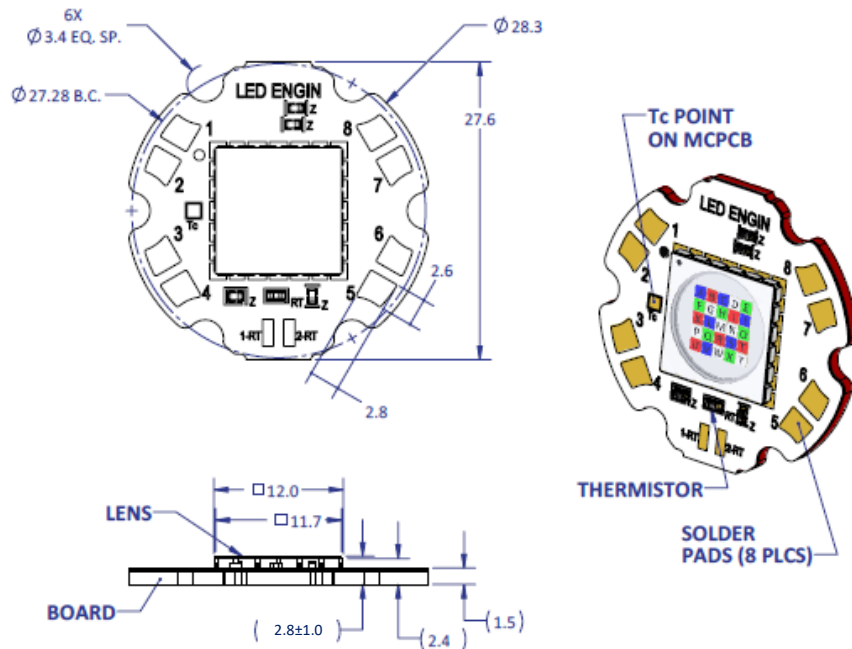

**Note:**

- Unless otherwise noted, the tolerance =  $\pm 0.20$  mm.
- Slots in MCPCB are for M3 or #4-40 mounting screws.
- The thermal resistance of the MCPCB is:  $R_{\theta C-B}$  0.1°C/W

## Components used

MCPCB: MHE-301 copper  
 ESD chips: BZX884-B39  
 NTC: NCP15XH103F03RC

(Rayben)  
 (NXP, for 6-7 LED dies in series)  
 (Murata)

Pad layout			
Ch.	MCPCB Pad	String/die	Function
1 (Red)	8	1/ BIKRTU	Anode +
	1		Cathode -
2 (Green)	7	2/ EFHOQX	Anode +
	2		Cathode -
3 (Blue)	6	3/ ACJLSV	Anode +
	3		Cathode -
4 (White)	5	4/ DGMNPWY	Anode +
	4		Cathode -
NTC	1-RT	10kohm	NTCA
	2-RT	NTC	NTCB

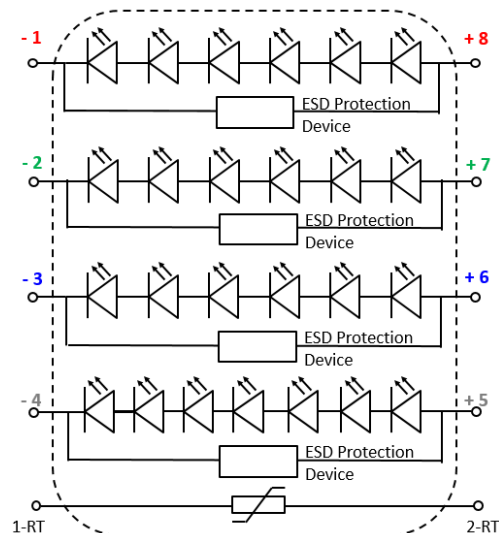



## Application Guidelines

### MCPCB Assembly Recommendations

A good thermal design requires an efficient heat transfer from the MCPCB to the heat sink. In order to minimize air gaps in between the MCPCB and the heat sink, it is common practice to use thermal interface materials such as thermal pastes, thermal pads, phase change materials and thermal epoxies. Each material has its pros and cons depending on the design. Thermal interface materials are most efficient when the mating surfaces of the MCPCB and the heat sink are flat and smooth. Rough and uneven surfaces may cause gaps with higher thermal resistances, increasing the overall thermal resistance of this interface. It is critical that the thermal resistance of the interface is low, allowing for an efficient heat transfer to the heat sink and keeping MCPCB temperatures low.

When optimizing the thermal performance, attention must also be paid to the amount of stress that is applied on the MCPCB. Too much stress can cause the ceramic emitter to crack. To relax some of the stress, it is advisable to use plastic washers between the screw head and the MCPCB and to follow the torque range listed below. For applications where the heat sink temperature can be above 50°C, it is recommended to use high temperature and rigid plastic washers, such as polycarbonate or glass-filled nylon.

LED Engin recommends the use of the following thermal interface materials:

1. Bergquist's Gap Pad 5000S35, 0.020in thick
  - Part Number: Gap Pad® 5000S35 0.020in/0.508mm
  - Thickness: 0.020in/0.508mm
  - Thermal conductivity: 5 W/m-K
  - Continuous use max temperature: 200°C
  - Using M3 Screw (or #4 screw), with polycarbonate or glass-filled nylon washer (#4) the recommended torque range is: 20 to 25 oz-in (1.25 to 1.56 lbf-in or 0.14 to 0.18 N-m)
  
2. 3M's Acrylic Interface Pad 5590H
  - Part number: 5590H @ 0.5mm
  - Thickness: 0.020in/0.508mm
  - Thermal conductivity: 3 W/m-K
  - Continuous use max temperature: 100°C
  - Using M3 Screw (or #4 screw), with polycarbonate or glass-filled nylon washer (#4) the recommended torque range is: 20 to 25 oz-in (1.25 to 1.56 lbf-in or 0.14 to 0.18 N-m)

### Mechanical Mounting Considerations

The mounting of MCPCB assembly is a critical process step. Excessive mechanical stress build up in the MCPCB can cause the MCPCB to warp which can lead to emitter substrate cracking and subsequent cracking of the LED dies

LED Engin recommends the following steps to avoid mechanical stress build up in the MCPCB:

- Inspect MCPCB and heat sink for flatness and smoothness.
- Select appropriate torque for mounting screws. Screw torque depends on the MCPCB mounting method (thermal interface materials, screws, and washer).
- Always use three M3 or #4-40 screws with #4 washers.
- When fastening the three screws, it is recommended to tighten the screws in multiple small steps. This method avoids building stress by tilting the MCPCB when one screw is tightened in a single step.
- Always use plastic washers in combinations with the three screws. This avoids high point contact stress on the screw head to MCPCB interface, in case the screw is not seated perpendicular.
- In designs with non-tapped holes using self-tapping screws, it is common practice to follow a method of three turns tapping a hole clockwise, followed by half a turn anti-clockwise, until the appropriate torque is reached.

## Wire Soldering

- To ease soldering wire to MCPCB process, it is advised to preheat the MCPCB on a hot plate of 125-150°C. Subsequently, apply the solder and additional heat from the solder iron will initiate a good solder reflow. It is recommended to use a solder iron of more than 60W.
- It is advised to use lead-free, no-clean solder. For example: SN-96.5 AG-3.0 CU 0.5 #58/275 from Kester (pn: 24-7068-7601)

## Company Information

LED Engin, Inc., based in California's Silicon Valley, specializes in ultra-bright, ultra compact solid state lighting solutions allowing lighting designers & engineers the freedom to create uncompromised yet energy efficient lighting experiences. The LuxiGen™ Platform — an emitter and lens combination or integrated module solution, delivers superior flexibility in light output, ranging from 3W to 90W, a wide spectrum of available colors, including whites, multi-color and UV, and the ability to deliver upwards of 5,000 high quality lumens to a target. The small size combined with powerful output allows for a previously unobtainable freedom of design wherever high-flux density, directional light is required. LED Engin's packaging technologies lead the industry with products that feature lowest thermal resistance, highest flux density and consummate reliability, enabling compact and efficient solid state lighting solutions.

LED Engin is committed to providing products that conserve natural resources and reduce greenhouse emissions.

LED Engin reserves the right to make changes to improve performance without notice.

Please contact [sales@ledengin.com](mailto:sales@ledengin.com) or (408) 922-7200 for more information.