



MPS-064TSNP0

MPS-T

POSITION SENSORS

SICK
Sensor Intelligence.



Ordering information

Type	Part no.
MPS-064TSNP0	1053836

Other models and accessories → www.sick.com/MPS-T



Detailed technical data

Features

Cylinder type	T-slot
Cylinder types with adapter	Round body cylinder Profile cylinders and tie-rod cylinders Dovetail groove cylinder SMC rail CDQ2 SMC rail ECDQ2 SMC cylinders with C-slot
Measuring range	64 mm ¹⁾
Housing length	77 mm
Output function	Analog
Electrical wiring	DC 4-wire
Analog output (voltage)	0 V ... 10 V ²⁾
Analog output (current)	4 mA ... 20 mA ²⁾
Enclosure rating	IP67 ³⁾
Cable outlet	Axial

¹⁾ , ± 1 mm.

²⁾ The sensor only activates the wired output.

³⁾ According to EN 60529.

Mechanics/electronics

Supply voltage	15 V DC ... 30 V DC ¹⁾
-----------------------	-----------------------------------

¹⁾ Reverse-polarity protected, operation in short-circuit protected network: max. 8 A.

²⁾ Without load.

³⁾ Voltage output.

⁴⁾ FSR: Full Scale Range; max. measuring range.

⁵⁾ At 25 ° C, linearity error (maximum deviation) depending on response curve and minimal deviation function.

⁶⁾ At 25 ° C, repeatability magnet movement in one direction.

⁷⁾ Only in standard mode, not in IO-Link mode.

⁸⁾ The analog measured value can deviate under transient conditions.

⁹⁾ Do not bend below 0 ° C.

Power consumption	≤ 22 mA ²⁾
Max. load resistance	500 Ω Power Output, at 24 V
Min. load resistance	≥ 2 kΩ ³⁾
Protection class	III
Time delay before availability	1.5 s
Required magnetic field sensitivity, typ.	3 mT
Resolution, typ.	0.03 % FSR (max. ≥ 0.05 mm) ⁴⁾
Linearity error, typ.	0.3 mm ⁵⁾
Repeat accuracy, typ.	0.06 % FSR (≥ 0.1 mm) ⁶⁾
Sampling rate, typ.	1 ms ⁷⁾
Status indicator LED	✓
Reverse polarity protection	✓
Short-circuit protection	✓
Ambient operating temperature	-20 °C ... +70 °C
Shock and vibration resistance	30 g, 11 ms / 10 ... 55 Hz, 1 mm
EMC	According to EN 60947-5-2 ⁸⁾
Housing material	Plastic
Connection type	Cable with M8 male connector, 4-pin, 0.3 m ⁹⁾
Cable material	PUR
Conductor cross-section	0.08 mm ²
UL File No.	NRKH.E181493 & NRKH7.E181493

- 1) Reverse-polarity protected, operation in short-circuit protected network: max. 8 A.
 2) Without load.
 3) Voltage output.
 4) FSR: Full Scale Range; max. measuring range.
 5) At 25 °C, linearity error (maximum deviation) depending on response curve and minimal deviation function.
 6) At 25 °C, repeatability magnet movement in one direction.
 7) Only in standard mode, not in IO-Link mode.
 8) The analog measured value can deviate under transient conditions.
 9) Do not bend below 0 °C.

Classifications

ECI@ss 5.0	27270104
ECI@ss 5.1.4	27270104
ECI@ss 6.0	27270104
ECI@ss 6.2	27270104
ECI@ss 7.0	27270104
ECI@ss 8.0	27270104
ECI@ss 8.1	27270104
ECI@ss 9.0	27270104
ETIM 5.0	EC002544
ETIM 6.0	EC002544
UNSPSC 16.0901	39122230

Connection diagram

cd-034

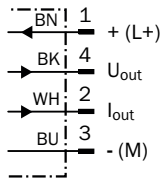

Dimensional drawing (Dimensions in mm (inch))

Without teach-in

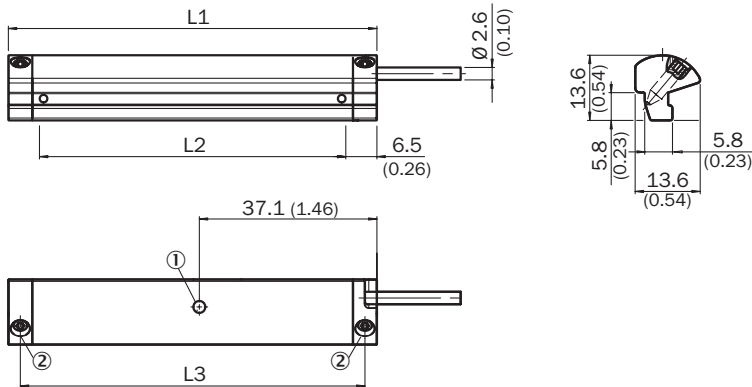











- ① Function indicator
- ② Fixing screw

	Total length (L1) mm	Measuring range (L2) mm	Distance mounting screws (L3) mm
MPS-32	45	32	40
MPS-64	77	64	72
MPS-96	109	96	104
MPS-128	141	128	136
MPS-160	173	160	168
MPS-192	205	192	200
MPS-224	237	224	232
MPS-256	269	256	264

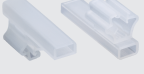
Recommended accessories

Other models and accessories → www.sick.com/MPS-T

	Brief description	Type	Part no.
Brackets for cylinder sensors			
	Mounting bracket for cylinder with dovetail slot, Aluminum, without mounting hardware	BEF-KHZ-ST1	2022703
	Mounting bracket for integrated profile cylinder/tie-rod cylinder, Zinc diecast, mounting hardware included	BEF-KHZ-PT1	2022702
	1 piece, Mounting bracket on round body cylinder with piston diameter of 12 mm, ambient temperature min 0 °C max 50 °C, Plastic, Aluminum	BEF-KHZ-RT-12	2077681
	1 piece, Mounting bracket on round body cylinder with piston diameter of 16 mm, ambient temperature min 0 °C max 50 °C, Plastic, Aluminum	BEF-KHZ-RT-16	2077680
	1 piece, Mounting bracket on round body cylinder with piston diameter of 20 mm, ambient temperature min 0 °C max 50 °C, Plastic, Aluminum	BEF-KHZ-RT-20	2077679
	1 piece, Mounting bracket on round body cylinder with piston diameter of 25 mm, ambient temperature min 0 °C max 50 °C, Plastic, Aluminum	BEF-KHZ-RT-25	2077678

	Brief description	Type	Part no.
	1 piece, Mounting bracket on round body cylinder with piston diameter of 32 mm, ambient temperature min 0 °C max 50 °C, Plastic, Aluminum	BEF-KHZ-RT-32	2077677
	1 piece, Mounting bracket on round body cylinder with piston diameter of 40 mm, ambient temperature min 0 °C max 50 °C, Plastic, Aluminum	BEF-KHZ-RT-40	2077676
	1 piece, Mounting bracket on round body cylinder with piston diameter of 50 mm, ambient temperature min 0 °C max 50 °C, Plastic, Aluminum	BEF-KHZ-RT-50	2077675
	1 piece, Mounting bracket on round body cylinder with piston diameter of 63 mm, ambient temperature min 0 °C max 50 °C, Plastic, Aluminum	BEF-KHZ-RT-63	2077674
	1 piece, Mounting bracket on round body cylinder with piston diameter of 8 mm ... 130 mm, ambient temperature min -30 °C max 80 °C, stainless steel, Zinc cast	BEF-KHZ-RT1-130	2077684
	1 piece, Mounting bracket on round body cylinder with piston diameter of 8 mm ... 25 mm, ambient temperature min -30 °C max 80 °C, stainless steel, Zinc cast	BEF-KHZ-RT1-25	2077682
	1 piece, Mounting bracket on round body cylinder with piston diameter of 8 mm ... 63 mm, ambient temperature min -30 °C max 80 °C, stainless steel, Zinc cast	BEF-KHZ-RT1-63	2077683
	Mounting bracket for mounting on SMC rails CDQ2 (T-slot), Aluminum, without mounting hardware	BEF-KHZ-TT2	2046440
	Mounting bracket for mounting on SMC rails ECDQ2 (T-slot), Aluminum, without mounting hardware	BEF-KHZ-TT1	2046439
Other mounting accessories			
	Cable clips T-slot, 10 pcs./bag	CABLE CLIPS	2059322
	10 pieces, Label Holder, 2.5 mm to 3.5 mm, 10 pcs., TPU	LABEL HOLDER	2086019
Plug connectors and cables			
	Head A: female connector, M8, 4-pin, straight, A-coded Head B: Flying leads Cable: Sensor/actuator cable, PUR, halogen-free, unshielded, 2 m	YF8U14-020UA3XLEAX	2094791
	Head A: female connector, M8, 4-pin, straight, A-coded Head B: Flying leads Cable: Sensor/actuator cable, PUR, halogen-free, unshielded, 5 m	YF8U14-050UA3XLEAX	2094792
	Head A: female connector, M8, 4-pin, angled, A-coded Head B: Flying leads Cable: Sensor/actuator cable, PUR, halogen-free, unshielded, 2 m	YG8U14-020UA3XLEAX	2095589
	Head A: female connector, M8, 4-pin, angled, A-coded Head B: Flying leads Cable: Sensor/actuator cable, PUR, halogen-free, unshielded, 5 m	YG8U14-050UA3XLEAX	2095590
	Head A: female connector, M8, 4-pin, straight Head B: - Cable: unshielded	DOS-0804-G	6009974
	Head A: female connector, M8, 4-pin, angled Head B: - Cable: unshielded	DOS-0804-W	6009975
	Head A: male connector, M8, 4-pin, straight Head B: - Cable: unshielded	STE-0804-G	6037323

SICK AT A GLANCE

SICK is one of the leading manufacturers of intelligent sensors and sensor solutions for industrial applications. A unique range of products and services creates the perfect basis for controlling processes securely and efficiently, protecting individuals from accidents and preventing damage to the environment.

We have extensive experience in a wide range of industries and understand their processes and requirements. With intelligent sensors, we can deliver exactly what our customers need. In application centers in Europe, Asia and North America, system solutions are tested and optimized in accordance with customer specifications. All this makes us a reliable supplier and development partner.

Comprehensive services complete our offering: SICK LifeTime Services provide support throughout the machine life cycle and ensure safety and productivity.

For us, that is “Sensor Intelligence.”

WORLDWIDE PRESENCE:

Contacts and other locations –www.sick.com