

HYBRID STEPPER MOTORS



17H



23H



34H

If you're looking for higher performance in a smaller package, this is it. The **h3** provides a torque output increase while reducing the package size and weight within your application. Higher duty cycles can be achieved through superior heat dissipation, made possible by the unique aluminum housing design of the motor. Learn more about our One Giant Leap In Stepper Technology.

Portescap

WHAT IS AN h3 STEPPER MOTOR	192
HOW TO SELECT YOUR	
h3 STEPPER MOTOR	193
h3 INFORMATION	194
SPECIFICATIONS	198

MOTION SOLUTIONS THAT MOVE LIFE FORWARD.™



WHY AN **h** HIGH-TORQUE HOUSED HYBRID STEPPER MOTOR

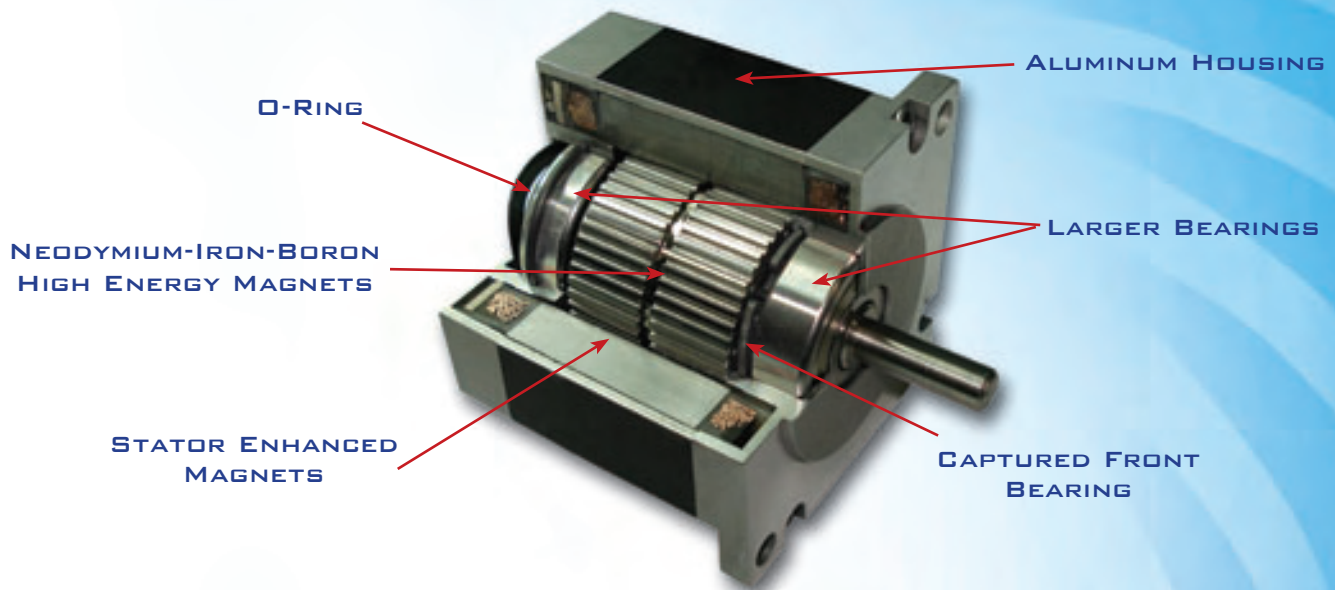

INNOVATION & PERFORMANCE

The **h** Stepper (High-Torque Housed Hybrid) innovates the traditional hybrid stepper motor by offering several unique design enhancements that expand the possibilities of the motor's applications. **h** motors incorporate innovative cooling technology, high torque magnetic design, rugged and captured bearings, and optimized torque density through enhancing magnets.

The Portescap engineering team provides quick prototype delivery and optimization of windings based on application requirements. Higher-level customization is also available to reduce customer assembly time and inventory levels. Thanks to the combination of features on the **h** Stepper, it's able to provide best in class performance.

Portescap can customize the **h** Stepper to provide an easier manufacturing process, with options including shaft modifications, windings, connectors, shaft adders (gear/pinions), and encoders. Let Portescap work with your design engineers to create the ideal motion solution for your application needs.

h STANDARD FEATURES

- **Holding torque**
NEMA 17 up to 73 oz-in/0.51 N-m
NEMA 23 up to 524 oz-in/3.7 N-m
NEMA 34 up to 1,613 oz-in/11.39 N-m
- **UL and CE agency certified**
- **RoHS Compliant**

• **Higher Torque**

Neodymium-Iron-Boron High Energy Magnets → Optimized torque density

• **Cooler**

Aluminum Housing → Superior heat dissipation for improved torque output, allowing heat to be distributed along the length of the motor

• **Quieter**

O-Ring → Prevents bearing spinout and decreases motor noise by minimizing contact between bearing and end bell

• **Enhanced Torque**

Stator Enhanced Magnets → Deliver up to 40% more torque in the same package through optimized torque density

• **Mechanical Stability**

Captured Front Bearing → Minimized motor noise, prevents spinout and eliminates shaft axial play from bearing axial movement

YOUR CUSTOM MOTOR

- **Available in sizes NEMA 17, 23 and 34**
- **Unipolar and bipolar windings available**
- **Various stack lengths available in each frame size**
- **Shaft modifications, including hollow shafts**
- **Lead length modifications and connectors**
- **Encoders**

HOW TO SELECT YOUR **h3** MOTOR

PRODUCT RANGE CHART	NEMA 17		NEMA 23		NEMA 34	
	Standard	Enhanced	Standard	Enhanced	Standard	Enhanced
Short Stack	h3		h3	h3		
1 Stack	h3		h3	h3	h3	h3
2 Stack	h3		h3	h3	h3	h3
3 Stack			h3	h3	h3	h3
Short Stack Linear Actuator	h3		h3	h3		
1 Stack Linear Actuator			h3	h3		
2 Stack Linear Actuator	h3					
3 Stack Linear Actuator						



h3 MOTOR DESIGNATION

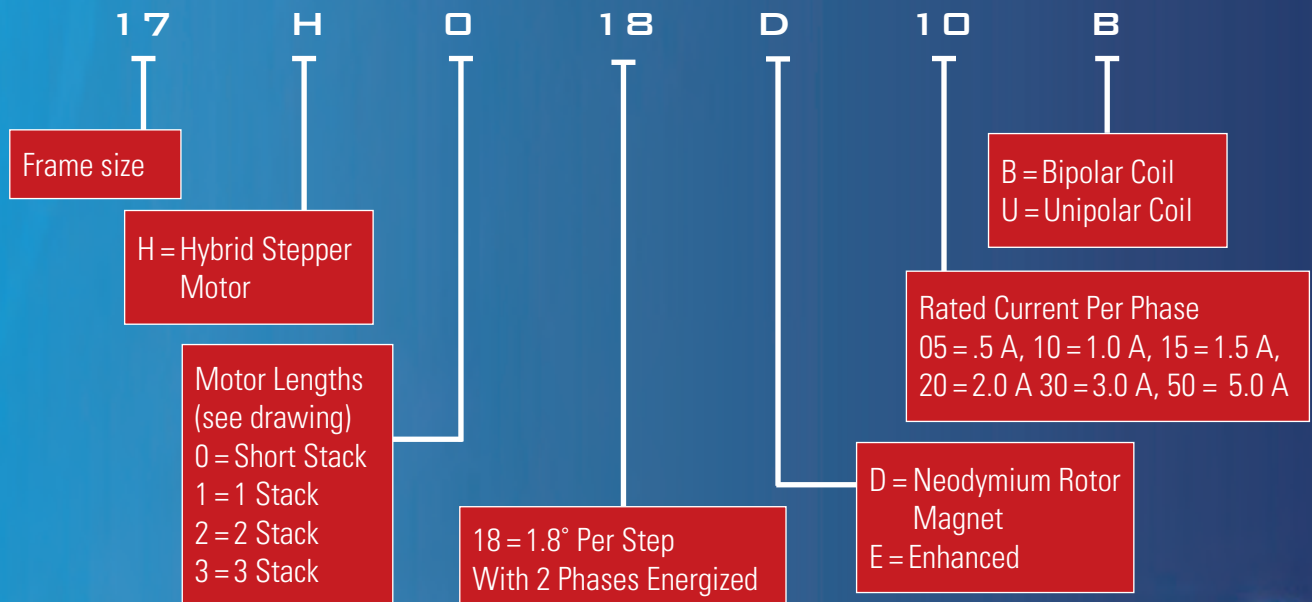

BASIC STEPPER MOTOR OPERATION

h series step motors have two windings (two phases) that are energized with DC current. When the current in one winding is reversed, the motor shaft moves one step, or 1.8°. By reversing the current in each winding, the position and speed of the motor is easily and precisely controlled, making these motors extremely useful for many different motion control applications.

For even finer resolution and smoother operation, micro-stepping drives divide each step into many increments by controlling the magnitude of the current in each winding.

The performance of hybrid step motors is highly dependent on the current and voltage supplied by a drive. **h** Stepper motors are available with a variety of windings so they can be used with drives that have a broad range of voltage and current ratings. Performance curves are included in this catalog for many common motor drive combinations.

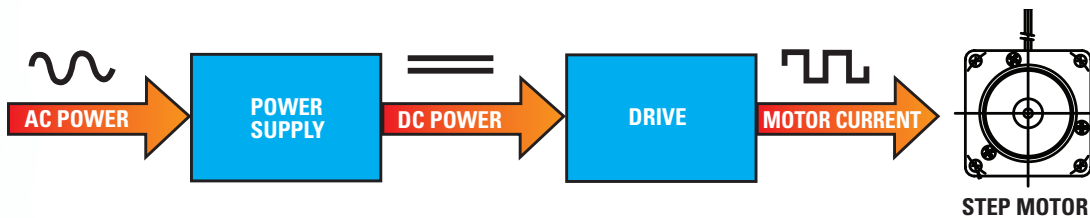

HOLDING TORQUE

Because motor performance at speed varies greatly with the drive, holding torque is used to rate hybrid step motors. Holding torque specifies the maximum torque that can be applied to a motor shaft and not cause the shaft to rotate. It is measured with the motor at standstill and energized with rated DC current. Since the motor is energized with pure DC current, holding torque is not dependent on specific drive characteristics.

h ENHANCING TECHNOLOGY

- Smaller drives = Lower system cost
- More torque = Smaller, faster machines
- Higher efficiency = Lower operating costs

Through the use of enhancing technology, **h** Stepper motors provide the maximum performance available. This technology boosts torque up to 40% across the operating speed range and allows machines to be designed that are smaller and move faster.

Initial system costs are often less with enhanced motors because the additional torque is produced without the need for larger drives or power supplies. The additional output power is produced through higher efficiency. The higher efficiency reduces energy usage by 25% and lowers operating costs.

Enhanced **h** motors use additional magnets inserted between each stator tooth. These magnets block the magnet fields from flowing around the stator teeth. This forces more of the magnetic field to flow through each tooth where it produces torque.

STANDARD STEPPER MOTOR

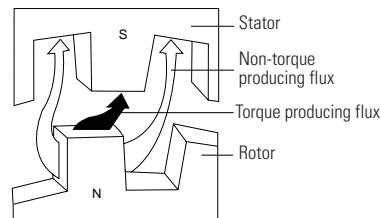

Typical paths of flux transfer in an energized conventional hybrid step motor. Some flux leakage occurs in normal operation.

ENHANCED STEPPER MOTOR

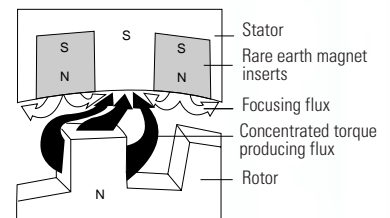

Enhancing technology redirects magnetic flux to inhibit leakage and optimize torque production.

TORQUE ENHANCEMENT PERCENTAGES

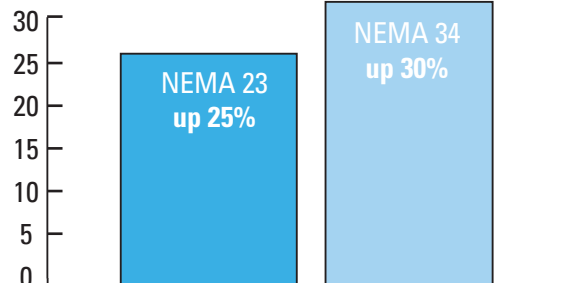

BASIC STEPPER MOTOR OPERATION

- Typical hybrid stepper motors are constructed with a spring washer that pushes on the ball bearings (preloads the bearings). This is done to reduce bearing noise, increase bearing life, and keep the rotor in position.

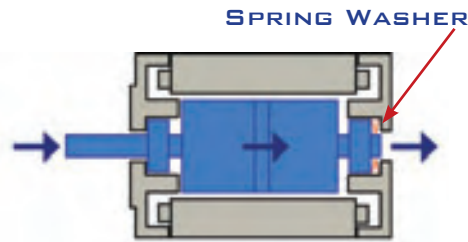

- If the front bearing is not retained, limited axial force can be applied to the front shaft and not cause the rotor to move in the motor.
- As the axial load force becomes greater than the spring washer force, the rotor moves in the stator. This causes whatever is attached to the motor shaft to also shift position.
- This can cause a number of problems. For example, if a leadscrew is attached to the motor shaft the linear load will not be in position.

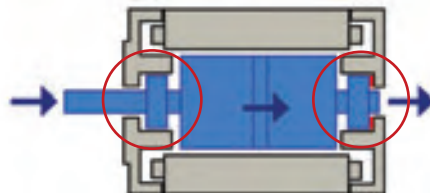

- To prevent this unwanted shaft movement, all size 23 & size 34 **h** series motors are provided with a snap ring behind the front bearing that locks the bearing in place even under very heavy axial loads. This snap ring, combined with the oversized bearings used in the **h** series, is a great feature.

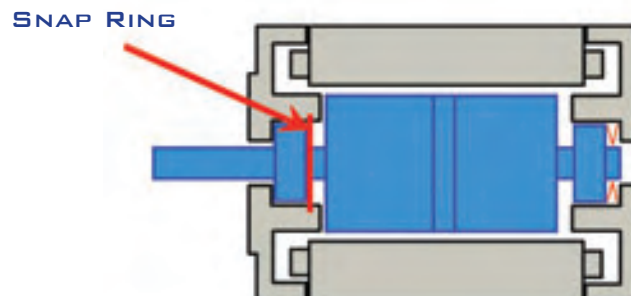

- **h** series construction are ideal for leadscrew applications because it often allows the customer to eliminate separate leadscrew thrust bearings and support structures.
- This construction is also very beneficial when the motors are used with encoders. The captured bearing prevents shaft movement that causes the encoder disc to rub and fail.



EXPLANATION OF SPECIFICATIONS

MOTOR PART NUMBER		23HX18D10B		EXPLANATION
RESISTANCE PER PHASE, ± 10%	ohms		5.70	Winding resistance dictated by magnet wire diameter and # of turns
INDUCTANCE PER PHASE, TYP	mH		11.15	Winding inductance dictated by magnet wire diameter and # of turns
RATED CURRENT PER PHASE *	amps		1.0	Current rating of motor – motor can be run continuously at this current
HOLDING TORQUE, MIN *	oz-in / N-m		75 / 0.53	When energized, the amount of torque to move from one mechanical step to the next
DETENT TORQUE, MAX	oz-in / N-m		6.0 / 0.042	When un-energized, the amount of torque to move from one mechanical step to the next
THERMAL RESISTANCE	o C/watt		3.99	
ROTOR MOMENT OF INERTIA	oz-in-s2/ kg-cm2		.0026 / 0.19	Inertia of the rotor
STEP ANGLE, ± 5% *	degrees		1.80	360 deg / number of mechanical steps of the motor
STEPS PER REVOLUTION *	-		200.00	Number of mechanical steps of the motor
AMBIENT TEMPERATURE RANGE				
OPERATING	o C		-20 ~ +40	Temperature range which the motor will operate
STORAGE			-40 ~ +85	Storage temperature where the motor will operate
BEARING TYPE	-		BALL BEARING	Dual ball bearings
INSULATION RESISTANCE AT 500VDC	Mohms		100 MEGOHMS	
DIELECTRIC WITHSTANDING VOLTAGE	vac		1800 FOR 1 SECOND	
WEIGHT	lbs / kg		1.0 / 0.45	Weight of the motor
SHAFT LOAD RATINGS, MAX		RADIAL	20 / 9 (AT SHAFT CENTER)	Maximum load that can be applied against the shaft
		AXIAL	50 / 23 (BOTH DIRECTIONS)	Maximum load that can be applied directly down the shaft
LEADWIRES	-		AWG 22, UL 3266	Rating of the lead wires
TEMPERATURE CLASS, MAX	-		B (130°C)	Maximum temperature of the winding insulation
RoHS	-		COMPLIANT	

23H218DXB • PULL-OUT TORQUE VS SPEED
AT 24VDC, 1-2 STEP, CONSTANT CURRENT, BIPOLAR CHOPPER

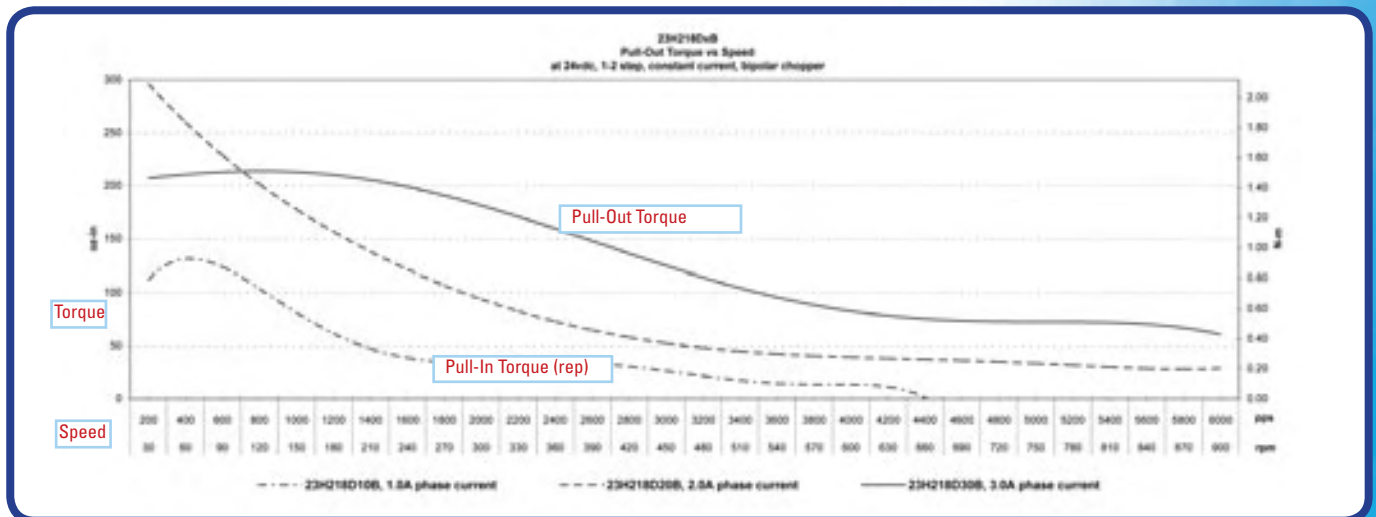

DEFINITIONS

- Pull-Out Torque** The amount of torque that the motor can produce at speed without stalling
- Pull-In Torque** The amount of torque that the motor can produce from zero speed without stalling
- Speed** # of pulses per second provided to the motor, also stated in revolutions per minute
- Voltage** Voltage applied to the drive
- Current** Current applied to the drive
- Drive** Chopper type drive - current controlled to the motor winding

WHERE TO APPLY YOUR **h** STEPPER

THE **h** STEPPER (HIGH-TORQUE HOUSED HYBRID) IS DESIGNED TO MEET THE BROAD SPECTRUM OF STEPPER MOTOR APPLICATIONS IN VARIOUS MARKETS:



FOCUS ON: MEDICAL PUMP

The requirement of the application was to operate smoothly, without resonance, over the entire speed range (1 to 1,000 RPM). A hybrid stepper running roughly would cause the incorrect amount of medicine to be dispensed. Many hybrids were tested, but the **h** Stepper provided smooth operation over the entire speed range, a minimal resonance band and higher output torque. Now the medicine dispensing speed can be varied as designed, without need to compensate for motor roughness.



MEDICAL & LAB AUTOMATION

- Peristaltic & syringe pumps
- Analyzers
- Optical scanners
- Pharmacy dispensing machines
- Dental imaging
- Fluid handling & movement systems



TEXTILE

- Yarn monitoring system
- Carpet tufting pattern machine
- Rotor or ring spinning
- Electronic wire winding
- XY garment cutting table



FACTORY AUTOMATION

- Semiconductor equipment
- Electronic assembly
- Packaging equipment
- Conveyors



TELECOMMUNICATION

- Cell phone masts
- GPS
- Antenna positioning
- Radar array



OTHER

- Printer & copier automation
- Ticketing
- Office automation
- Electronic assembly
- Engraving



Motor Part Number			17HX18D05B	17HX18D10B	17HX18D15B
			17HX18D05B-D	17HX18D10B-D	17HX18D15B-D
Resistance per phase, ± 10%	Short Stack	ohms	13.28	3.32	1.47
	1 Stack	ohms	16.48	4.12	1.83
	2 Stack	ohms	17.96	4.49	2.00
Inductance per phase, typ	Short Stack	mH	17.70	3.80	1.60
	1 Stack	mH	20.20	6.50	2.85
	2 Stack	mH	26.70	6.50	3.20
Rated current per phase *		amps	0.5	1.0	1.5
Holding torque, typical *	Short Stack	oz-in / Nm		30 / 0.21	
	1 Stack	oz-in / Nm		51 / 0.36	
	2 Stack	oz-in / Nm		65 / 0.46	
Thermal resistance	Short Stack	°C/watt		6.21	
	1 Stack	°C/watt		5.40	
	2 Stack	°C/watt		4.71	
Detent torque, typical	Short Stack	oz-in / Nm		1.6 / 0.011	
	1 Stack	oz-in / Nm		2.5 / 0.017	
	2 Stack	oz-in / Nm		3.2 / 0.023	
Rotor moment of inertia	Short Stack	oz-in-s ² / kg-cm ²		.00051 / 0.04	
	1 Stack	oz-in-s ² / kg-cm ²		.00075 / 0.05	
	2 Stack	oz-in-s ² / kg-cm ²		.00106 / 0.07	
Step angle, ± 5% *		degrees		1.8	
Steps per revolution *				200	
Ambient temperature range					
Operating		°C		-20 ~ +40	
Storage		°C		-40 ~ +85	
Bearing type				Ball bearing	
Insulation resistance at 500vdc		Mohms		100 megohms	
Dielectric withstanding voltage		vac		1200 for 1 second	
Weight	Short Stack	lb / kg		0.45 / 0.20	
	1 Stack	lb / kg		0.57 / 0.26	
	2 Stack	lb / kg		0.76 / 0.34	
Shaft load ratings, max at 1500 rpm					
Radial		lb / kg		15 / 6.8 (at shaft center)	
Axial		lb / kg		6 / 2.7 (Push)	
Axial		lb / kg		15 / 6.8 (Pull)	
Leadwires				AWG 26 UL 3266	
Temperature class, max				B (130°C)	
RoHS				COMPLIANT	

ALL MOTOR DATA VALUES AT 20°C UNLESS OTHERWISE SPECIFIED
 * ENERGISE AT RATED CURRENT, 2 PHASE ON

17HX18D (Contd..)

Motor Part Number			17HX18D05U	17HX18D10U	17HX18D15U
			17HX18D05U-D	17HX18D10U-D	17HX18D15U-D
Resistance per phase, ± 10%	Short Stack	ohms	13.28	3.32	1.47
	1 Stack	ohms	16.48	4.12	1.83
	2 Stack	ohms	17.96	4.49	2.00
Inductance per phase, typ	Short Stack	mH	6.05	1.55	0.84
	1 Stack	mH	9.65	2.85	1.15
	2 Stack	mH	11.30	3.20	1.55
Rated current per phase *		amps	0.5	1.0	1.5
Holding torque, typical *	Short Stack	oz-in / Nm		21 / 0.15	
	1 Stack	oz-in / Nm		38 / 0.27	
	2 Stack	oz-in / Nm		47 / 0.33	
Thermal resistance	Short Stack	°C/watt		6.21	
	1 Stack	°C/watt		5.40	
	2 Stack	°C/watt		4.71	
Detent torque, typical	Short Stack	oz-in / Nm		1.6 / 0.011	
	1 Stack	oz-in / Nm		2.5 / 0.017	
	2 Stack	oz-in / Nm		3.2 / 0.023	
Rotor moment of inertia	Short Stack	oz-in-s ² / kg-cm ²		.00051 / 0.04	
	1 Stack	oz-in-s ² / kg-cm ²		.00075 / 0.05	
	2 Stack	oz-in-s ² / kg-cm ²		.00106 / 0.07	
Step angle, ± 5% *		degrees		1.8	
Steps per revolution *				200	
Ambient temperature range					
Operating		°C		-20 ~ +40	
Storage		°C		-40 ~ +85	
Bearing type				Ball bearing	
Insulation resistance at 500vdc		Mohms		100 megohms	
Dielectric withstanding voltage		vac		1200 for 1 second	
Weight	Short Stack	lb / kg		0.45 / 0.20	
	1 Stack	lb / kg		0.57 / 0.26	
	2 Stack	lb / kg		0.76 / 0.34	
Shaft load ratings, max at 1500 rpm					
Radial		lb / kg		15 / 6.8 (at shaft center)	
Axial		lb / kg		6 / 2.7 (Push)	
Axial		lb / kg		15 / 6.8 (Pull)	
Leadwires				AWG 26 UL 3266	
Temperature class, max				B (130°C)	
RoHS				COMPLIANT	

ALL MOTOR DATA VALUES AT 20°C UNLESS OTHERWISE SPECIFIED
 * ENERGISE AT RATED CURRENT, 2 PHASE ON

23HX18D

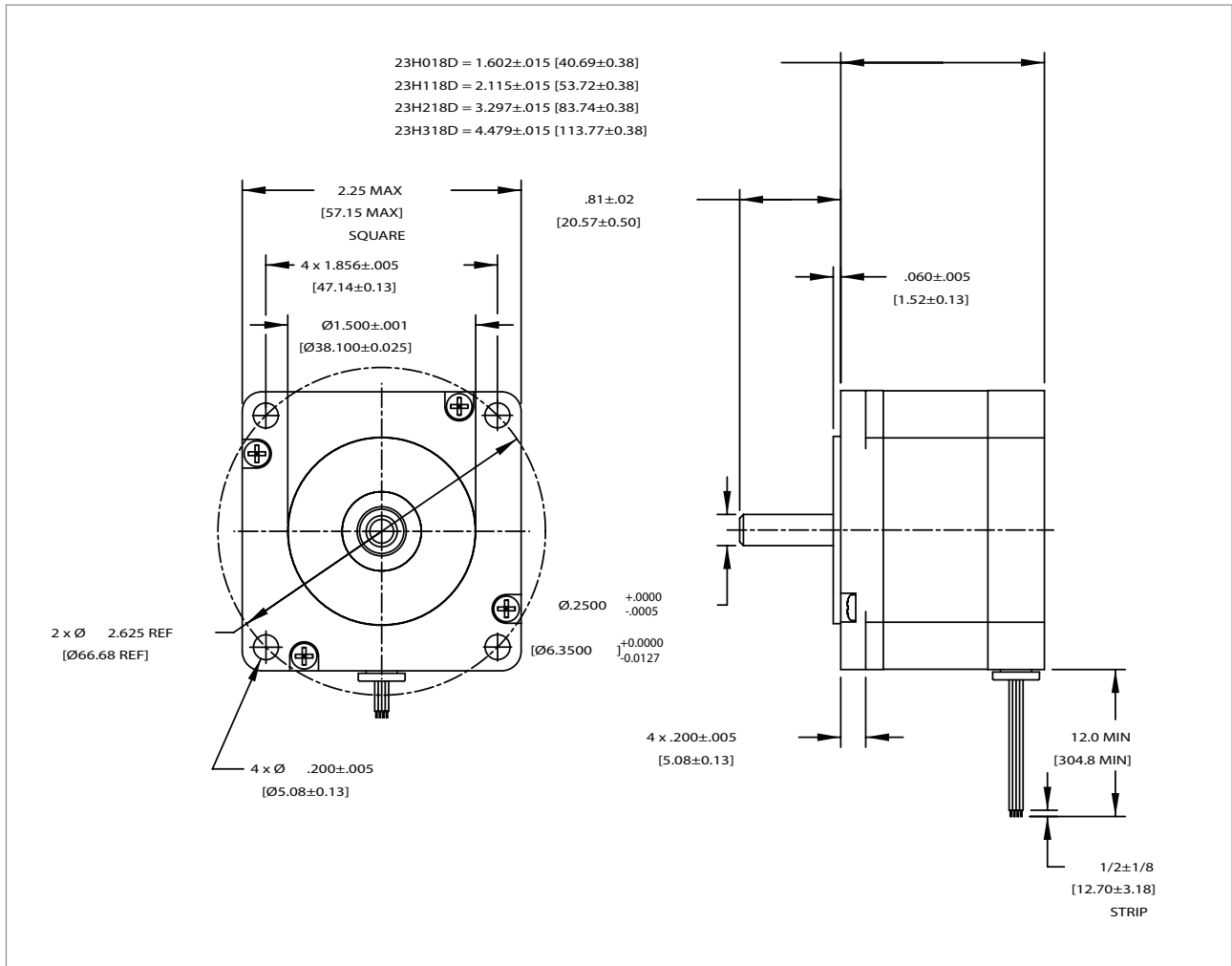

Stepper

23HX18D

Motor Part Number			23HX18D10B	23HX18D20B	23HX18D30B
Rated voltage	Short Stack	vdc	5.70	2.86	1.89
	1 Stack	vdc	6.84	3.42	2.28
	2 Stack	vdc	8.50	4.26	2.82
	3 Stack	vdc	10.75	5.38	3.57
Resistance per phase, ± 10%	Short Stack	ohms	5.70	1.43	0.63
	1 Stack	ohms	6.84	1.71	0.76
	2 Stack	ohms	8.50	2.13	0.94
	3 Stack	ohms	10.75	2.69	1.19
Inductance per phase, typ	Short Stack	mH	11.15	2.66	1.21
	1 Stack	mH	25.56	6.10	2.78
	2 Stack	mH	34.28	8.33	3.92
	3 Stack	mH	43.52	13.35	4.99
Rated current per phase *		amps	1.0	2.0	3.0
Holding torque, typical *	Short Stack	oz-in / Nm		75 / 0.53	
	1 Stack	oz-in / Nm		180 / 1.27	
	2 Stack	oz-in / Nm		330 / 2.33	
	3 Stack	oz-in / Nm		400 / 2.82	
Detent torque, typical	Short Stack	oz-in / Nm		6.0 / 0.042	
	1 Stack	oz-in / Nm		9.0 / 0.064	
	2 Stack	oz-in / Nm		15.0 / 0.106	
	3 Stack	oz-in / Nm		18.0 / 0.127	
Thermal resistance	Short Stack	°C/watt		3.99	
	1 Stack	°C/watt		3.57	
	2 Stack	°C/watt		2.62	
	3 Stack	°C/watt		1.58	
Rotor moment of inertia	Short Stack	oz-in-s ² / kg-cm ²		.0026 / 0.19	
	1 Stack	oz-in-s ² / kg-cm ²		.0035 / 0.24	
	2 Stack	oz-in-s ² / kg-cm ²		.0068 / 0.48	
	3 Stack	oz-in-s ² / kg-cm ²		.0102 / 0.72	
Step angle, ± 5% *		degrees		1.8	
Steps per revolution *				200	
Ambient temperature range					
Operating		°C		-20 ~ +40	
Storage		°C		-40 ~ +85	
Bearing type				Ball bearing	
Insulation resistance at 500vdc		Mohms		100 megohms	
Dielectric withstanding voltage		vac		1200 for 1 second	
Weight	Short Stack	lb / kg		1.0 / 0.45	
	1 Stack	lb / kg		1.4 / 0.64	
	2 Stack	lb / kg		2.4 / 1.09	
	3 Stack	lb / kg		3.4 / 1.55	
Shaft load ratings, max at 1500 rpm					
Radial		lb / kg		20 / 9 (at shaft center)	
Axial		lb / kg		50 / 23 (Both directions)	
Leadwires				AWG 22 UL 3266	
Temperature class, max				B (130°C)	
RoHS				COMPLIANT	

ALL MOTOR DATA VALUES AT 25°C UNLESS OTHERWISE SPECIFIED
 * ENERGISE AT RATED CURRENT, 2 PHASE ON

Motor Part Number			23HX18D10U	23HX18D20U	23HX18D30U
Rated voltage	Short Stack	vdc	5.70	2.86	1.89
	1 Stack	vdc	6.84	3.42	2.28
	2 Stack	vdc	8.50	4.26	2.82
	3 Stack	vdc	10.75	5.38	3.57
Resistance per phase, ± 10%	Short Stack	ohms	5.70	1.43	0.63
	1 Stack	ohms	6.84	1.71	0.76
	2 Stack	ohms	8.50	2.13	0.94
	3 Stack	ohms	10.75	2.69	1.19
Inductance per phase, typ	Short Stack	mH	7.06	1.66	0.76
	1 Stack	mH	13.10	2.97	1.46
	2 Stack	mH	21.32	5.33	1.97
	3 Stack	mH	26.79	6.44	3.34
Rated current per phase *		amps	1.0	2.0	3.0
Holding torque, typical *	Short Stack	oz-in / Nm		60 / 0.42	
	1 Stack	oz-in / Nm		135 / 0.95	
	2 Stack	oz-in / Nm		235 / 1.66	
	3 Stack	oz-in / Nm		300 / 2.12	
Detent torque, typical	Short Stack	oz-in / Nm		6.0 / 0.042	
	1 Stack	oz-in / Nm		9.0 / 0.064	
	2 Stack	oz-in / Nm		15.0 / 0.106	
	3 Stack	oz-in / Nm		18.0 / 0.127	
Thermal resistance	Short Stack	°C/watt		3.99	
	1 Stack	°C/watt		3.57	
	2 Stack	°C/watt		2.62	
	3 Stack	°C/watt		1.58	
Rotor moment of inertia	Short Stack	oz-in-s ² / kg-cm ²		.0026 / 0.19	
	1 Stack	oz-in-s ² / kg-cm ²		.0035 / 0.24	
	2 Stack	oz-in-s ² / kg-cm ²		.0068 / 0.48	
	3 Stack	oz-in-s ² / kg-cm ²		.0102 / 0.72	
Step angle, ± 5% *		degrees		1.8	
Steps per revolution *				200	
Ambient temperature range					
Operating		°C		-20 ~ +40	
Storage		°C		-40 ~ +85	
Bearing type				Ball bearing	
Insulation resistance at 500vdc		Mohms		100 megohms	
Dielectric withstanding voltage		vac		1200 for 1 second	
Weight	Short Stack	lb / kg		1.0 / 0.45	
	1 Stack	lb / kg		1.4 / 0.64	
	2 Stack	lb / kg		2.4 / 1.09	
	3 Stack	lb / kg		3.4 / 1.55	
Shaft load ratings, max at 1500 rpm					
Radial		lb / kg		20 / 9 (at shaft center)	
Axial		lb / kg		50 / 23 (Both directions)	
Leadwires				AWG 22 UL 3266	
Temperature class, max				B (130°C)	
RoHS				COMPLIANT	

ALL MOTOR DATA VALUES AT 25°C UNLESS OTHERWISE SPECIFIED
 * ENERGISE AT RATED CURRENT, 2 PHASE ON

23HX18E

Motor Part Number			23HX18E10B	23HX18E20B	23HX18E30B
Rated voltage	Short Stack	vdc	5.70	2.86	1.89
	1 Stack	vdc	6.84	3.42	2.28
	2 Stack	vdc	8.50	4.26	2.82
	3 Stack	vdc	10.75	5.38	3.57
Resistance per phase, ± 10%	Short Stack	ohms	5.70	1.43	0.63
	1 Stack	ohms	6.84	1.71	0.76
	2 Stack	ohms	8.50	2.13	0.94
	3 Stack	ohms	10.75	2.69	1.19
Inductance per phase, typ	Short Stack	mH	11.15	2.66	1.21
	1 Stack	mH	25.56	6.10	2.78
	2 Stack	mH	34.28	8.33	3.92
	3 Stack	mH	43.52	13.35	4.99
Rated current per phase *		amps	1.0	2.0	3.0
Holding torque, typical *	Short Stack	oz-in / Nm		84 / 0.59	
	1 Stack	oz-in / Nm		227 / 1.60	
	2 Stack	oz-in / Nm		426 / 3.01	
	3 Stack	oz-in / Nm		524 / 3.70	
Detent torque, typical	Short Stack	oz-in / Nm		10.0 / 0.071	
	1 Stack	oz-in / Nm		15.0 / 0.106	
	2 Stack	oz-in / Nm		26.0 / 0.184	
	3 Stack	oz-in / Nm		31.0 / 0.219	
Thermal resistance	Short Stack	°C/watt		3.99	
	1 Stack	°C/watt		3.57	
	2 Stack	°C/watt		2.62	
	3 Stack	°C/watt		1.58	
Rotor moment of inertia	Short Stack	oz-in-s ² / kg-cm ²		.0026 / 0.19	
	1 Stack	oz-in-s ² / kg-cm ²		.0035 / 0.24	
	2 Stack	oz-in-s ² / kg-cm ²		.0068 / 0.48	
	3 Stack	oz-in-s ² / kg-cm ²		.0102 / 0.72	
Step angle, ± 5% *		degrees		1.8	
Steps per revolution *				200	
Ambient temperature range					
Operating		°C		-20 ~ +40	
Storage		°C		-40 ~ +85	
Bearing type				Ball bearing	
Insulation resistance at 500vdc		Mohms		100 megohms	
Dielectric withstanding voltage		vac		1200 for 1 second	
Weight	Short Stack	lb / kg		1.0 / 0.45	
	1 Stack	lb / kg		1.5 / 0.68	
	2 Stack	lb / kg		2.5 / 1.14	
	3 Stack	lb / kg		3.6 / 1.64	
Shaft load ratings, max at 1500 rpm					
Radial		lb / kg		20 / 9 (at shaft center)	
Axial		lb / kg		50 / 23 (Both directions)	
Leadwires				AWG 22 UL 3266	
Temperature class, max				B (130°C)	
RoHS				COMPLIANT	

ALL MOTOR DATA VALUES AT 25°C UNLESS OTHERWISE SPECIFIED
 * ENERGISE AT RATED CURRENT, 2 PHASE ON

Motor Part Number			23HX18E10U	23HX18E20U	23HX18E30U
Rated voltage	Short Stack	vdc	5.70	2.86	1.89
	1 Stack	vdc	6.84	3.42	2.28
	2 Stack	vdc	8.50	4.26	2.82
	3 Stack	vdc	10.75	5.38	3.57
Resistance per phase, ± 10%	Short Stack	ohms	5.70	1.43	0.63
	1 Stack	ohms	6.84	1.71	0.76
	2 Stack	ohms	8.50	2.13	0.94
	3 Stack	ohms	10.75	2.69	1.19
Inductance per phase, typ	Short Stack	mH	7.06	1.66	0.76
	1 Stack	mH	13.10	2.97	1.46
	2 Stack	mH	21.32	5.33	1.97
	3 Stack	mH	26.79	6.44	3.34
Rated current per phase *		amps	1.0	2.0	3.0
Holding torque, typical *	Short Stack	oz-in / Nm		72 / 0.51	
	1 Stack	oz-in / Nm		170 / 1.20	
	2 Stack	oz-in / Nm		303 / 2.14	
	3 Stack	oz-in / Nm		393 / 2.78	
Detent torque, typical	Short Stack	oz-in / Nm		10.0 / 0.071	
	1 Stack	oz-in / Nm		15.0 / 0.106	
	2 Stack	oz-in / Nm		26.0 / 0.184	
	3 Stack	oz-in / Nm		31.0 / 0.219	
Thermal resistance	Short Stack	°C/watt		3.99	
	1 Stack	°C/watt		3.57	
	2 Stack	°C/watt		2.62	
	3 Stack	°C/watt		1.58	
Rotor moment of inertia	Short Stack	oz-in-s ² / kg-cm ²		.0026 / 0.19	
	1 Stack	oz-in-s ² / kg-cm ²		.0035 / 0.24	
	2 Stack	oz-in-s ² / kg-cm ²		.0068 / 0.48	
	3 Stack	oz-in-s ² / kg-cm ²		.0102 / 0.72	
Step angle, ± 5% *		degrees		1.8	
Steps per revolution *				200	
Ambient temperature range					
Operating		°C		-20 ~ +40	
Storage		°C		-40 ~ +85	
Bearing type				Ball bearing	
Insulation resistance at 500vdc		Mohms		100 megohms	
Dielectric withstanding voltage		vac		1200 for 1 second	
Weight	Short Stack	lb / kg		1.0 / 0.45	
	1 Stack	lb / kg		1.5 / 0.68	
	2 Stack	lb / kg		2.5 / 1.14	
	3 Stack	lb / kg		3.6 / 1.64	
Shaft load ratings, max at 1500 rpm					
Radial		lb / kg		20 / 9 (at shaft center)	
Axial		lb / kg		50 / 23 (Both directions)	
Leadwires				AWG 22 UL 3266	
Temperature class, max				B (130°C)	
RoHS				COMPLIANT	

ALL MOTOR DATA VALUES AT 25°C UNLESS OTHERWISE SPECIFIED
 * ENERGISE AT RATED CURRENT, 2 PHASE ON

34HX18D

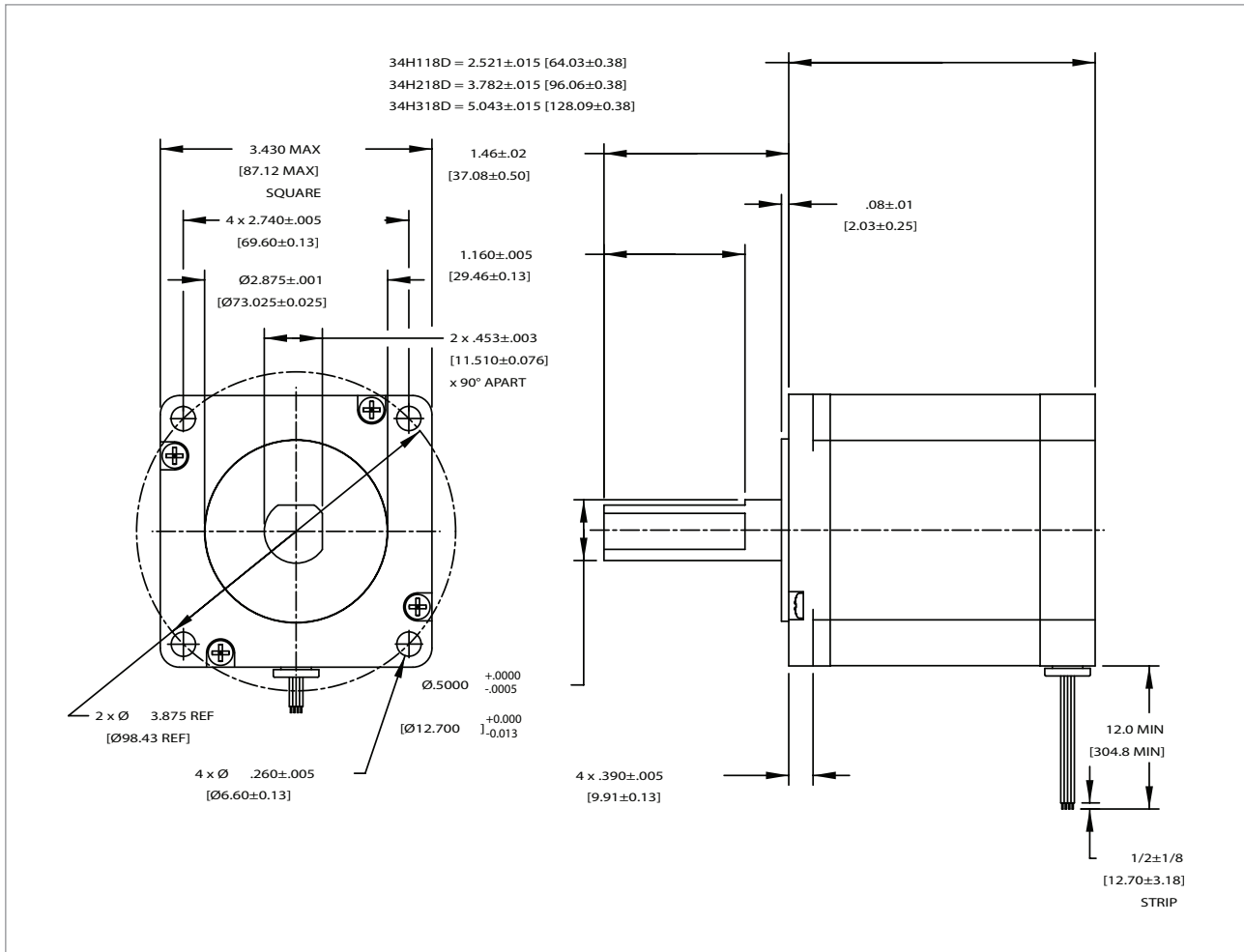

34HX18D

Motor Part Number			34HX18D10B	34HX18D30B	34HX18D50B
Rated voltage	1 Stack	vdc	11.90	3.96	2.40
	2 Stack	vdc	14.60	4.86	2.90
	3 Stack	vdc	18.00	6.00	3.60
Resistance per phase, ± 10%	1 Stack	ohms	11.90	1.32	0.48
	2 Stack	ohms	14.60	1.62	0.58
	3 Stack	ohms	18.00	2.00	0.72
Inductance per phase, typ	1 Stack	mH	87.61	8.29	2.43
	2 Stack	mH	125.69	15.46	4.73
	3 Stack	mH	146.41	17.64	6.76
Rated current per phase *		amps	1.0	3.0	5.0
Holding torque, typical *	1 Stack	oz-in / Nm		460 / 3.25	
	2 Stack	oz-in / Nm		820 / 5.79	
	3 Stack	oz-in / Nm		1290 / 9.11	
Detent torque, typical	1 Stack	oz-in / Nm		23 / 0.16	
	2 Stack	oz-in / Nm		30 / 0.21	
	3 Stack	oz-in / Nm		44 / 0.31	
Thermal resistance	1 Stack	°C/watt		2.02	
	2 Stack	°C/watt		1.55	
	3 Stack	°C/watt		1.36	
Rotor moment of inertia	1 Stack	oz-in-s ² / kg-cm ²		.0185 / 1.31	
	2 Stack	oz-in-s ² / kg-cm ²		.0370 / 2.61	
	3 Stack	oz-in-s ² / kg-cm ²		.0555 / 3.92	
Step angle, ± 5% *		degrees		1.8	
Steps per revolution *				200	
Ambient temperature range					
Operating		°C		-20 ~ +40	
Storage		°C		-40 ~ +85	
Bearing type				Ball bearing	
Insulation resistance at 500vdc		Mohms		100 megohms	
Dielectric withstanding voltage		vac		1200 for 1 second	
Weight	1 Stack	lb / kg		4.0 / 1.8	
	2 Stack	lb / kg		6.5 / 3.0	
	3 Stack	lb / kg		9.1 / 4.1	
Shaft load ratings, max at 1500 rpm					
Radial		lb / kg		65 / 29 (at shaft center)	
Axial		lb / kg		100 / 34 (Both directions)	
Leadwires				AWG 22 UL 3266	
Temperature class, max				B (130°C)	
RoHS				COMPLIANT	

ALL MOTOR DATA VALUES AT 25°C UNLESS OTHERWISE SPECIFIED
 * ENERGISE AT RATED CURRENT, 2 PHASE ON

34HX18D

Motor Part Number			34HX18D10U	34HX18D30U	34HX18D50U
Rated voltage	1 Stack	vdc	11.90	3.96	2.40
	2 Stack	vdc	14.60	4.86	2.90
	3 Stack	vdc	18.00	6.00	3.60
Resistance per phase, ± 10%	1 Stack	ohms	11.90	1.32	0.48
	2 Stack	ohms	14.60	1.62	0.58
	3 Stack	ohms	18.00	2.00	0.72
Inductance per phase, typ	1 Stack	mH	43.56	5.20	1.44
	2 Stack	mH	63.18	7.62	2.27
	3 Stack	mH	73.96	10.89	2.56
Rated current per phase *		amps	1.0	3.0	5.0
Holding torque, typical *	1 Stack	oz-in / Nm		370 / 2.61	
	2 Stack	oz-in / Nm		660 / 4.66	
	3 Stack	oz-in / Nm		950 / 6.71	
Detent torque, typical	1 Stack	oz-in / Nm		23 / 0.16	
	2 Stack	oz-in / Nm		30 / 0.21	
	3 Stack	oz-in / Nm		44 / 0.31	
Thermal resistance	1 Stack	°C/watt		2.02	
	2 Stack	°C/watt		1.55	
	3 Stack	°C/watt		1.36	
Rotor moment of inertia	1 Stack	oz-in-s ² / kg-cm ²		.0185 / 1.31	
	2 Stack	oz-in-s ² / kg-cm ²		.0370 / 2.61	
	3 Stack	oz-in-s ² / kg-cm ²		.0555 / 3.92	
Step angle, ± 5% *		degrees		1.8	
Steps per revolution *				200	
Ambient temperature range					
Operating		°C		-20 ~ +40	
Storage		°C		-40 ~ +85	
Bearing type				Ball bearing	
Insulation resistance at 500vdc		Mohms		100 megohms	
Dielectric withstanding voltage		vac		1200 for 1 second	
Weight	1 Stack	lb / kg		4.0 / 1.8	
	2 Stack	lb / kg		6.5 / 3.0	
	3 Stack	lb / kg		9.1 / 4.1	
Shaft load ratings, max at 1500 rpm					
Radial		lb / kg		65 / 29 (at shaft center)	
Axial		lb / kg		100 / 34 (Both directions)	
Leadwires				AWG 22 UL 3266	
Temperature class, max				B (130°C)	
RoHS				COMPLIANT	

ALL MOTOR DATA VALUES AT 25°C UNLESS OTHERWISE SPECIFIED
 * ENERGISE AT RATED CURRENT, 2 PHASE ON

Motor Part Number			34HX18E10B	34HX18E30B	34HX18E50B
Rated voltage	1 Stack	vdc	11.90	3.96	2.40
	2 Stack	vdc	14.60	4.86	2.90
	3 Stack	vdc	18.00	6.00	3.60
Resistance per phase, ± 10%	1 Stack	ohms	11.90	1.32	0.48
	2 Stack	ohms	14.60	1.62	0.58
	3 Stack	ohms	18.00	2.00	0.72
Inductance per phase, typ	1 Stack	mH	87.61	8.29	2.43
	2 Stack	mH	125.69	15.46	4.73
	3 Stack	mH	146.41	17.64	6.76
Rated current per phase *		amps	1.0	3.0	5.0
Holding torque, typical *	1 Stack	oz-in / Nm		552 / 3.90	
	2 Stack	oz-in / Nm		1009 / 7.13	
	3 Stack	oz-in / Nm		1613 / 11.39	
Detent torque, typical	1 Stack	oz-in / Nm		28 / 0.20	
	2 Stack	oz-in / Nm		37 / 0.26	
	3 Stack	oz-in / Nm		55 / 0.39	
Thermal resistance	1 Stack	°C/watt		2.02	
	2 Stack	°C/watt		1.55	
	3 Stack	°C/watt		1.36	
Rotor moment of inertia	1 Stack	oz-in-s ² / kg-cm ²		.0185 / 1.31	
	2 Stack	oz-in-s ² / kg-cm ²		.0370 / 2.61	
	3 Stack	oz-in-s ² / kg-cm ²		.0555 / 3.92	
Step angle, ± 5% *		degrees		1.8	
Steps per revolution *				200	
Ambient temperature range					
Operating		°C		-20 ~ +40	
Storage		°C		-40 ~ +85	
Bearing type				Ball bearing	
Insulation resistance at 500vdc		Mohms		100 megohms	
Dielectric withstanding voltage		vac		1200 for 1 second	
Weight	1 Stack	lb / kg		4.1 / 1.9	
	2 Stack	lb / kg		6.6 / 3.0	
	3 Stack	lb / kg		9.3 / 4.2	
Shaft load ratings, max at 1500 rpm					
Radial		lb / kg		65 / 29 (at shaft center)	
Axial		lb / kg		100 / 45 (Both directions)	
Leadwires				AWG 22 UL 3266	
Temperature class, max				B (130°C)	
RoHS				COMPLIANT	

ALL MOTOR DATA VALUES AT 25°C UNLESS OTHERWISE SPECIFIED
 * ENERGISE AT RATED CURRENT, 2 PHASE ON

34HX18E

Motor Part Number			34HX18E10U	34HX18E30U	34HX18E50U
Rated voltage	1 Stack	vdc	11.90	3.96	2.40
	2 Stack	vdc	14.60	4.86	2.90
	3 Stack	vdc	18.00	6.00	3.60
Resistance per phase, ± 10%	1 Stack	ohms	11.90	1.32	0.48
	2 Stack	ohms	14.60	1.62	0.58
	3 Stack	ohms	18.00	2.00	0.72
Inductance per phase, typ	1 Stack	mH	43.56	5.20	1.44
	2 Stack	mH	63.18	7.62	2.27
	3 Stack	mH	73.96	10.89	2.56
Rated current per phase *		amps	1.0	3.0	5.0
Holding torque, typical *	1 Stack	oz-in / Nm		444 / 3.14	
	2 Stack	oz-in / Nm		812 / 5.73	
	3 Stack	oz-in / Nm		1188 / 8.39	
Detent torque, typical	1 Stack	oz-in / Nm		28 / 0.20	
	2 Stack	oz-in / Nm		37 / 0.26	
	3 Stack	oz-in / Nm		55 / 0.39	
Thermal resistance	1 Stack	°C/watt		2.02	
	2 Stack	°C/watt		1.55	
	3 Stack	°C/watt		1.36	
Rotor moment of inertia	1 Stack	oz-in-s ² / kg-cm ²		.0185 / 1.31	
	2 Stack	oz-in-s ² / kg-cm ²		.0370 / 2.61	
	3 Stack	oz-in-s ² / kg-cm ²		.0555 / 3.92	
Step angle, ± 5% *		degrees		1.8	
Steps per revolution *				200	
Ambient temperature range					
Operating		°C		-20 ~ +40	
Storage		°C		-40 ~ +85	
Bearing type				Ball bearing	
Insulation resistance at 500vdc		Mohms		100 megohms	
Dielectric withstanding voltage		vac		1200 for 1 second	
Weight	1 Stack	lb / kg		4.1 / 1.9	
	2 Stack	lb / kg		6.6 / 3.0	
	3 Stack	lb / kg		9.3 / 4.2	
Shaft load ratings, max at 1500 rpm					
Radial		lb / kg		65 / 29 (at shaft center)	
Axial		lb / kg		100 / 45 (Both directions)	
Leadwires				AWG 22 UL 3266	
Temperature class, max				B (130°C)	
RoHS				COMPLIANT	

ALL MOTOR DATA VALUES AT 25°C UNLESS OTHERWISE SPECIFIED
 * ENERGISE AT RATED CURRENT, 2 PHASE ON

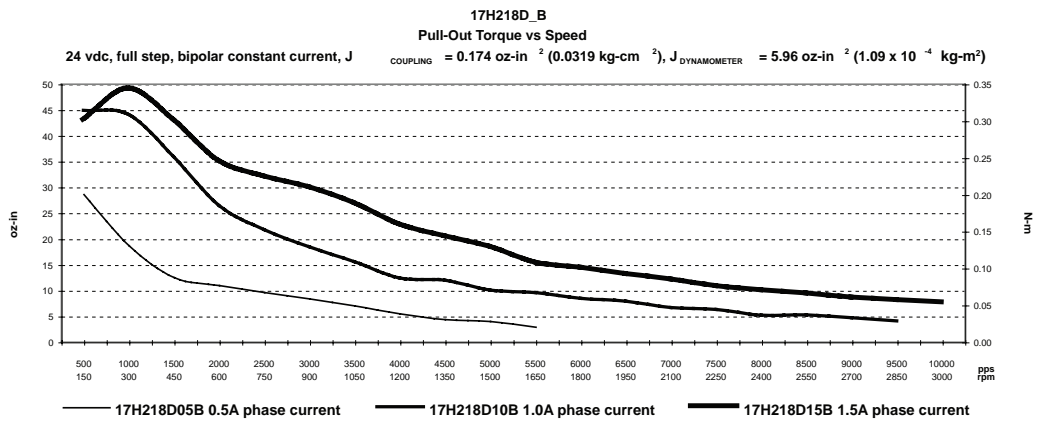
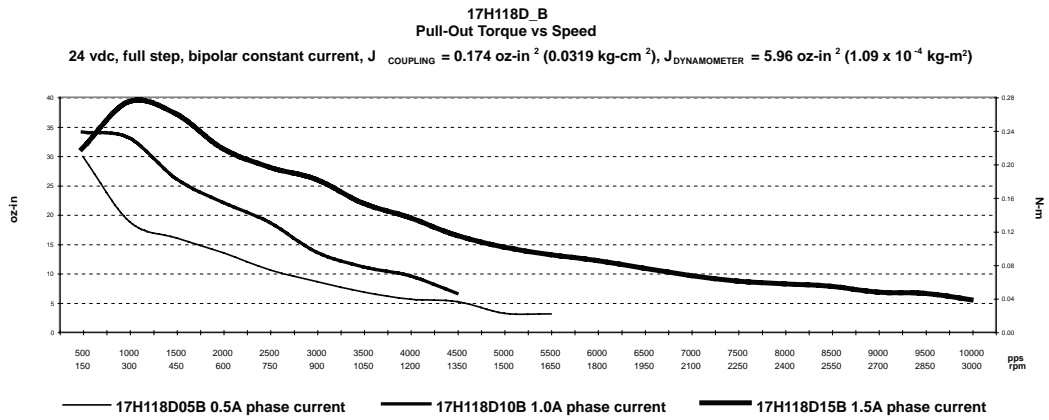
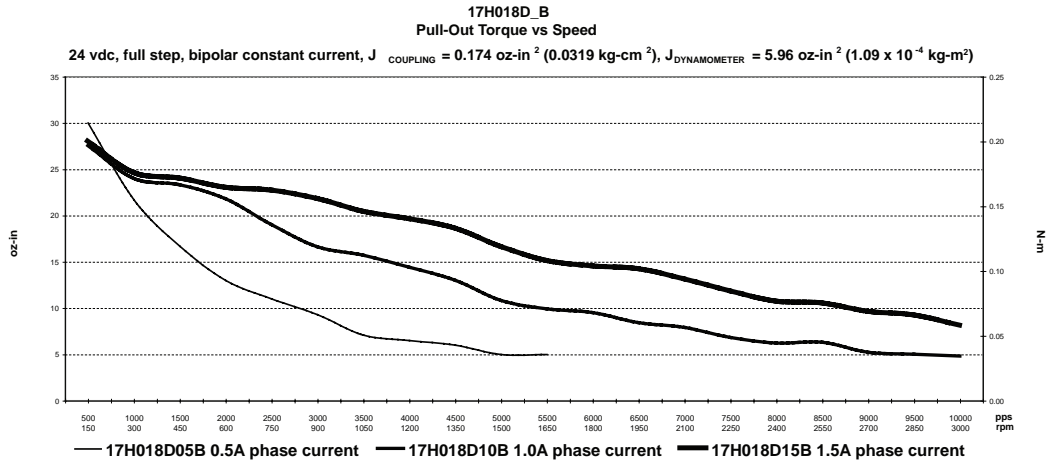

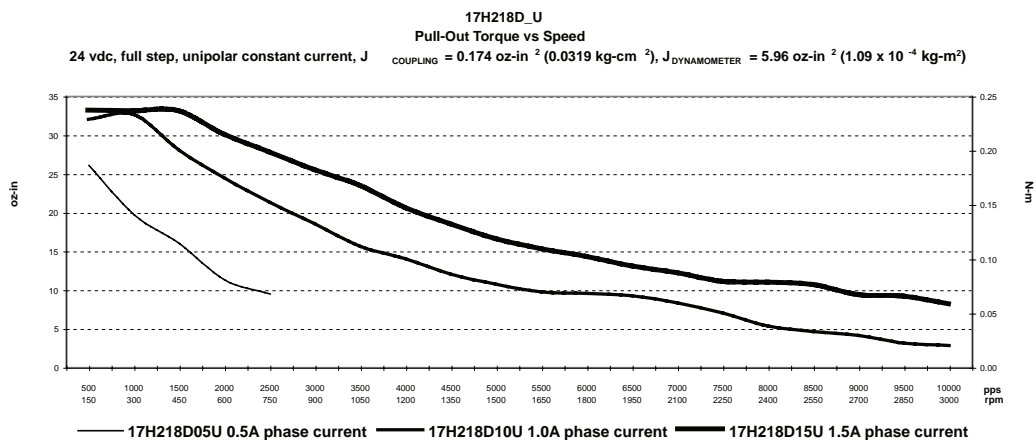
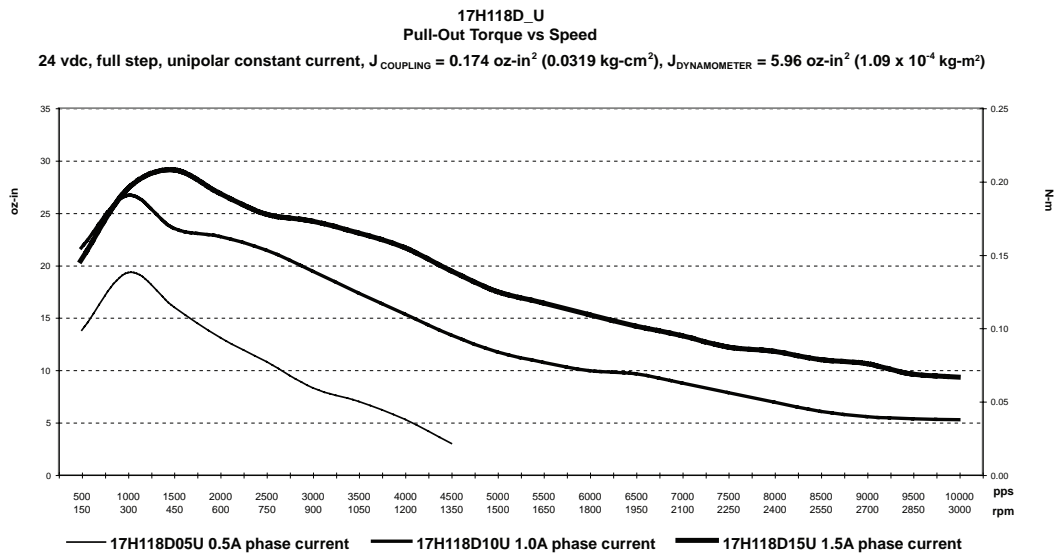
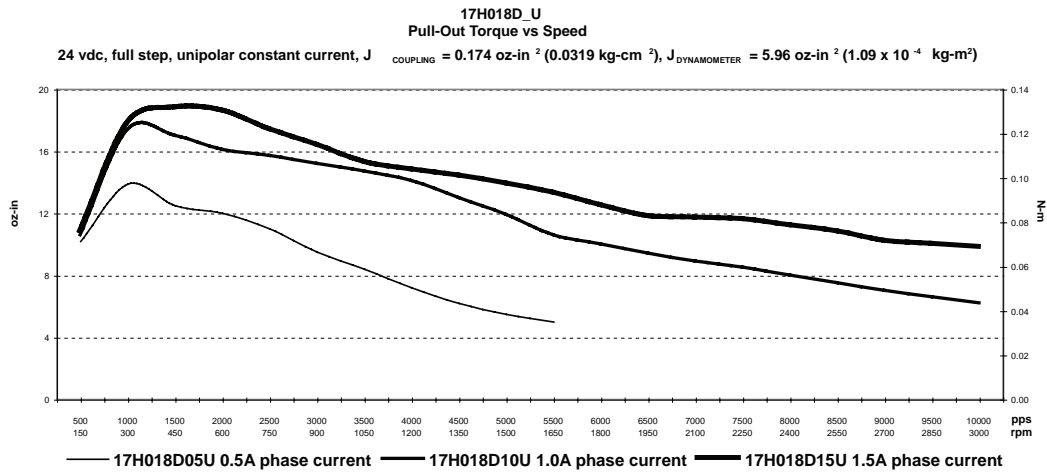

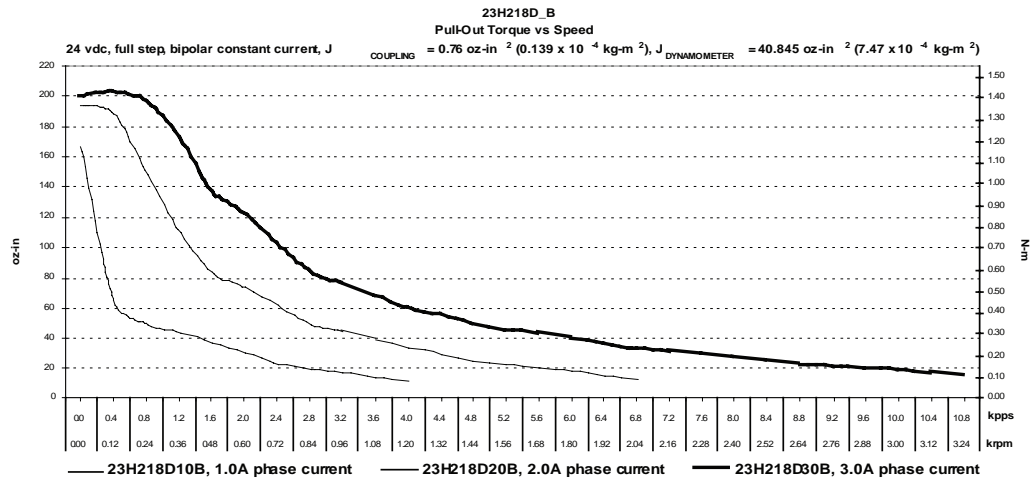
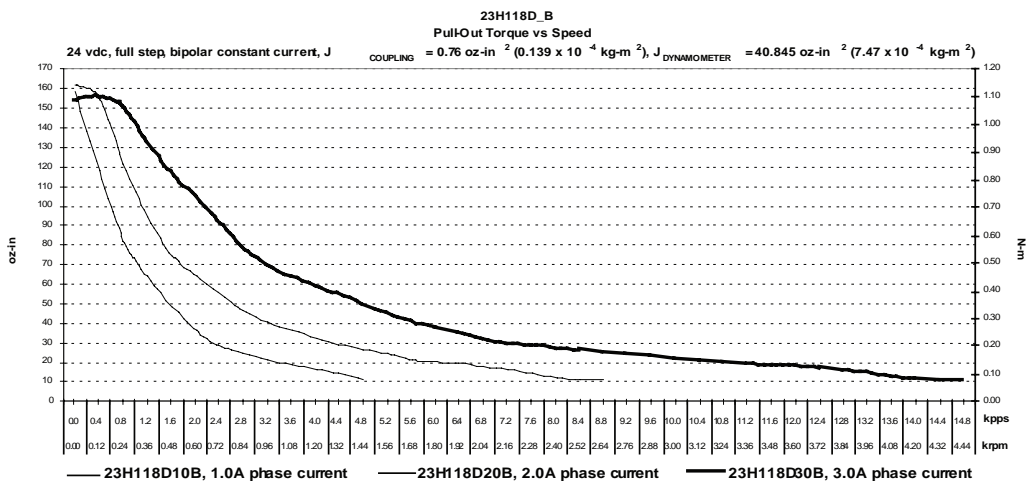
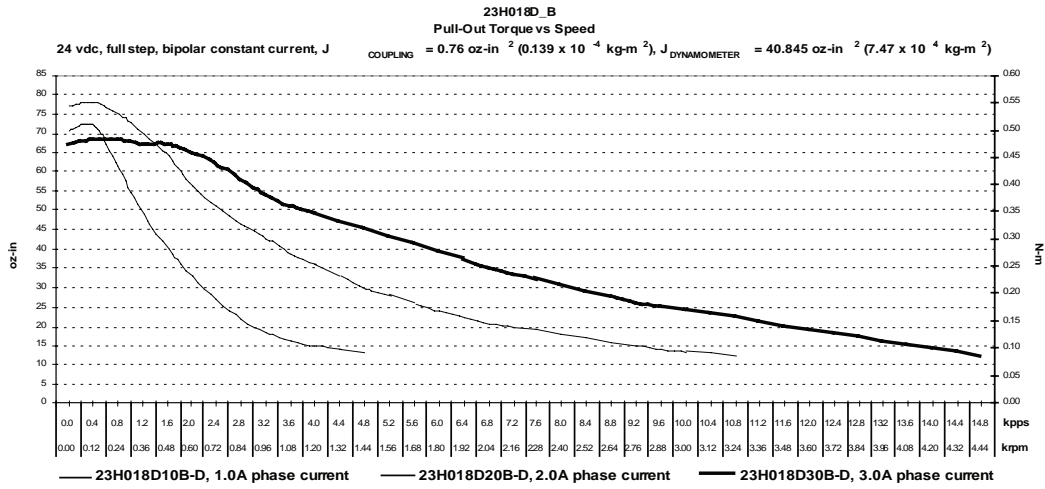

Stepper

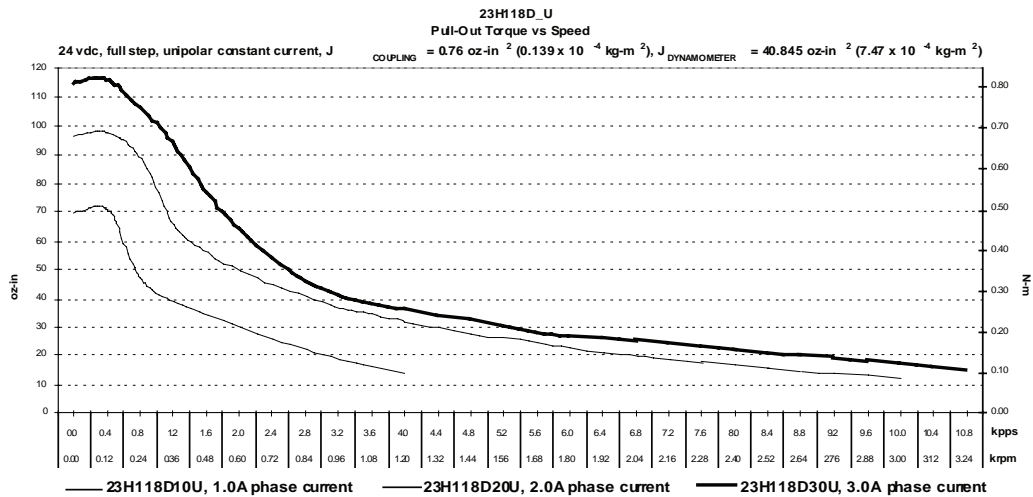
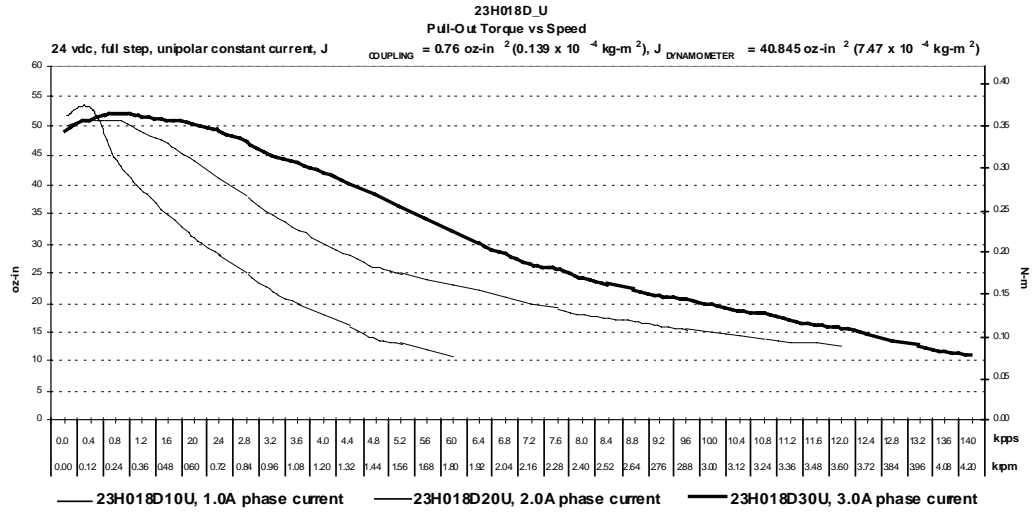
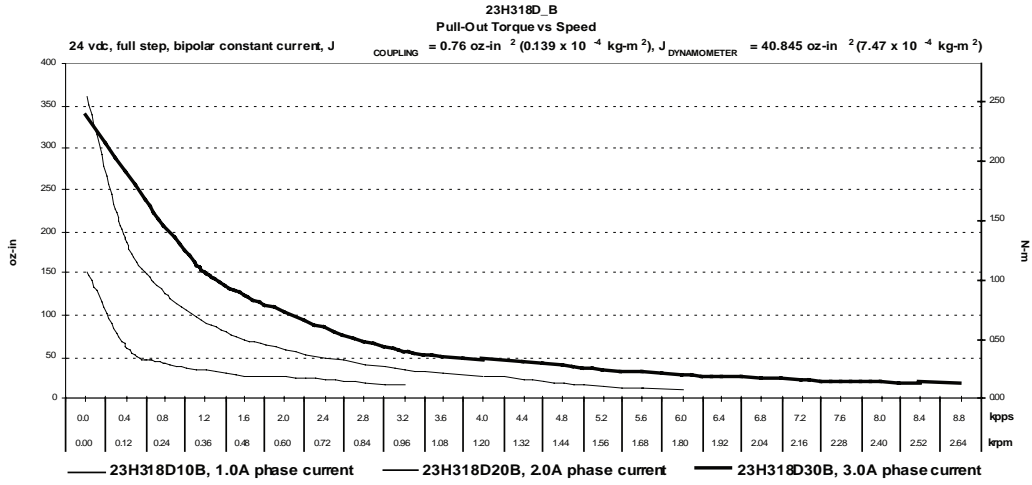

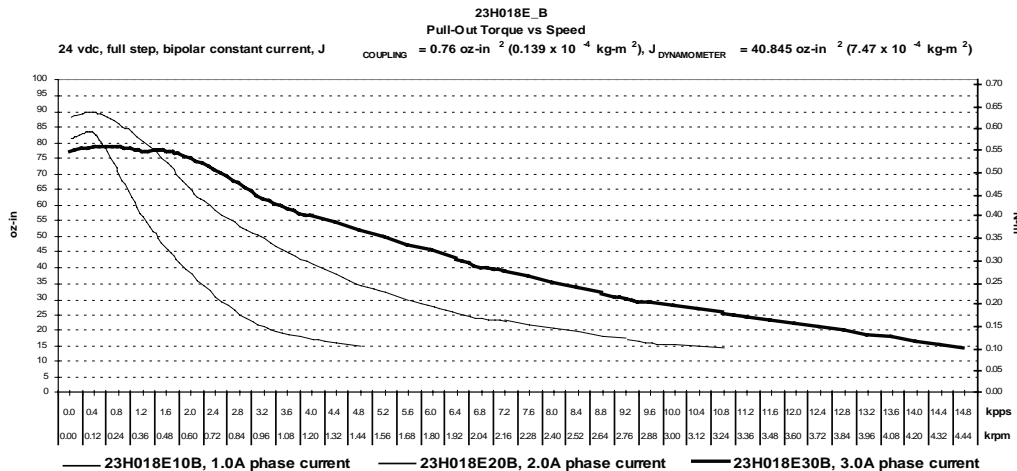
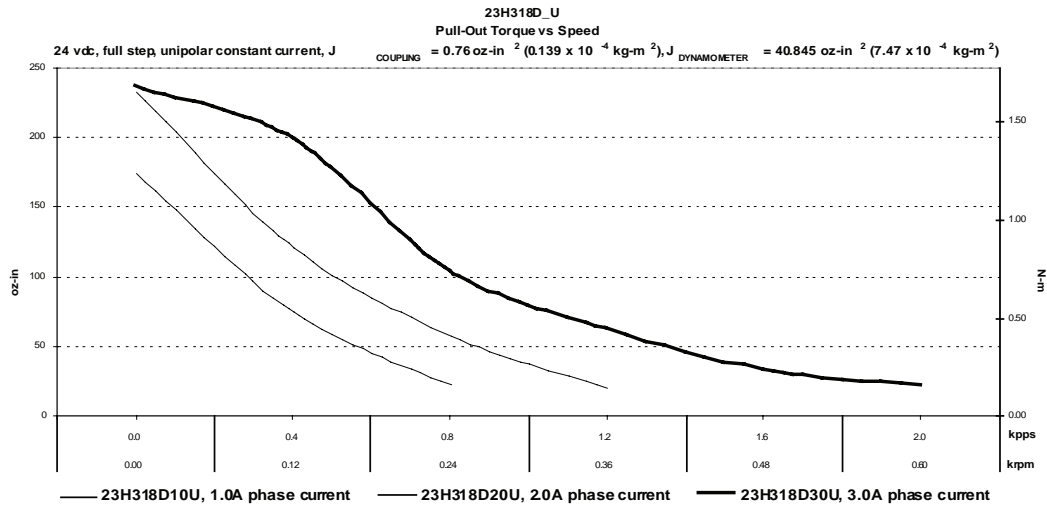
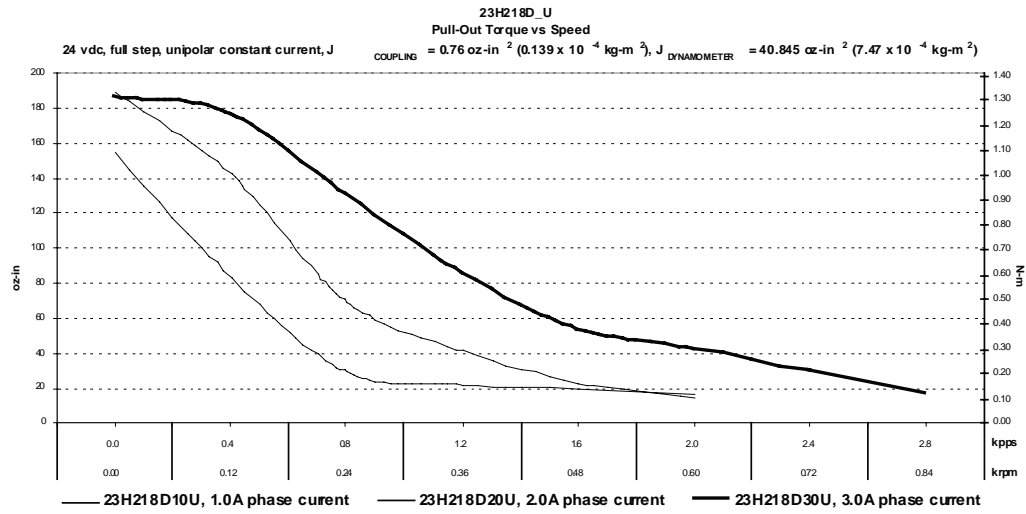

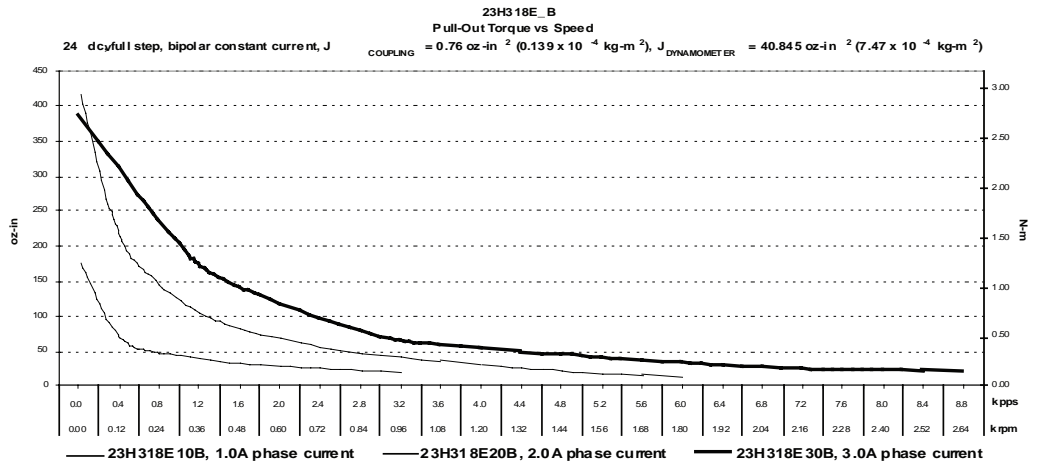
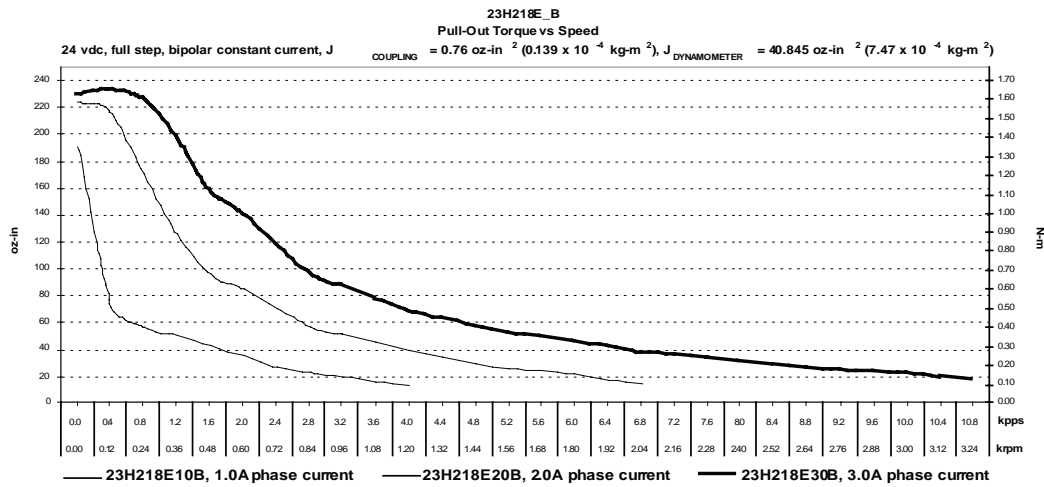
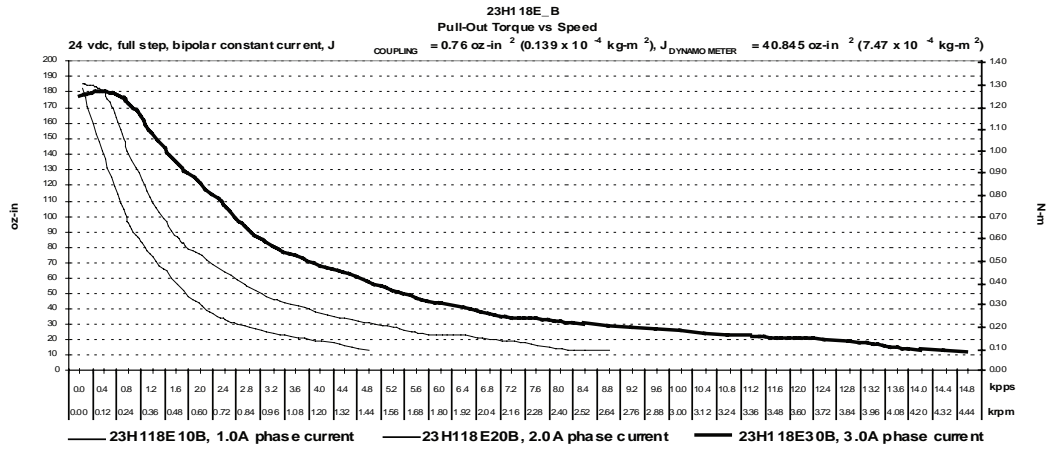

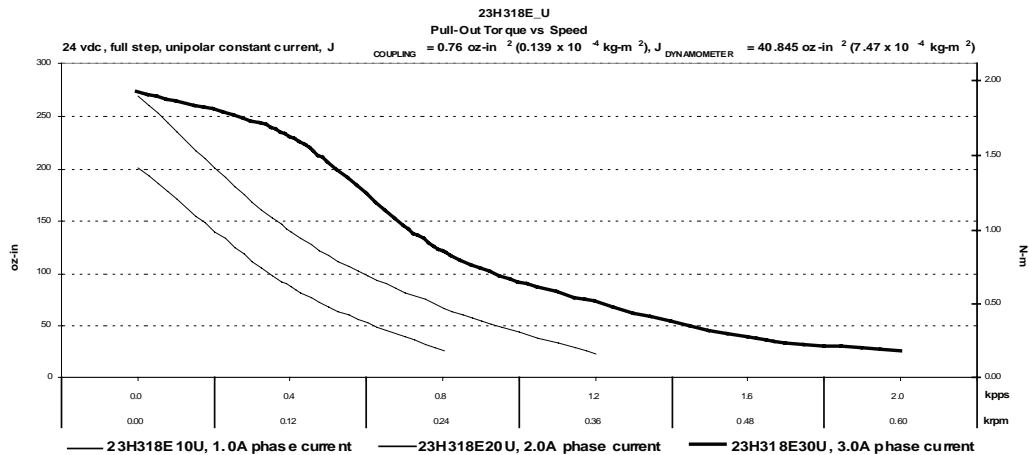
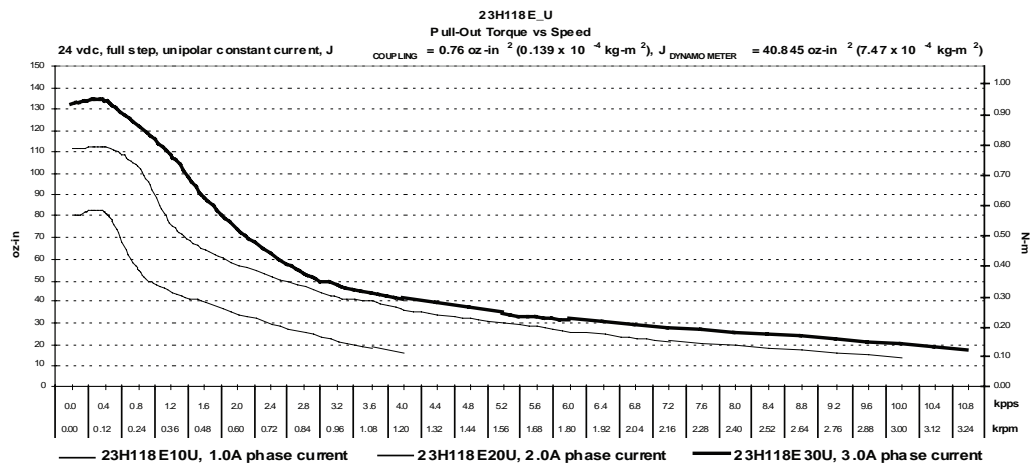
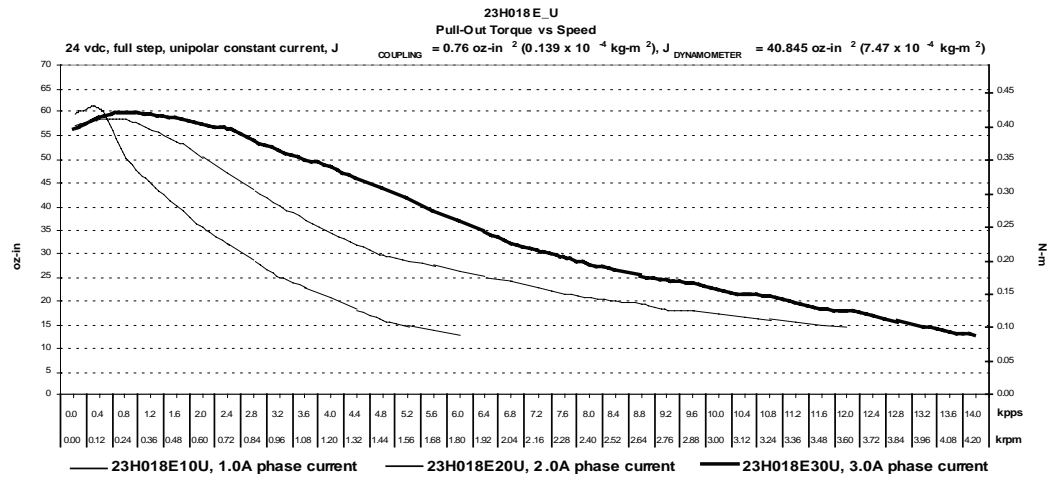

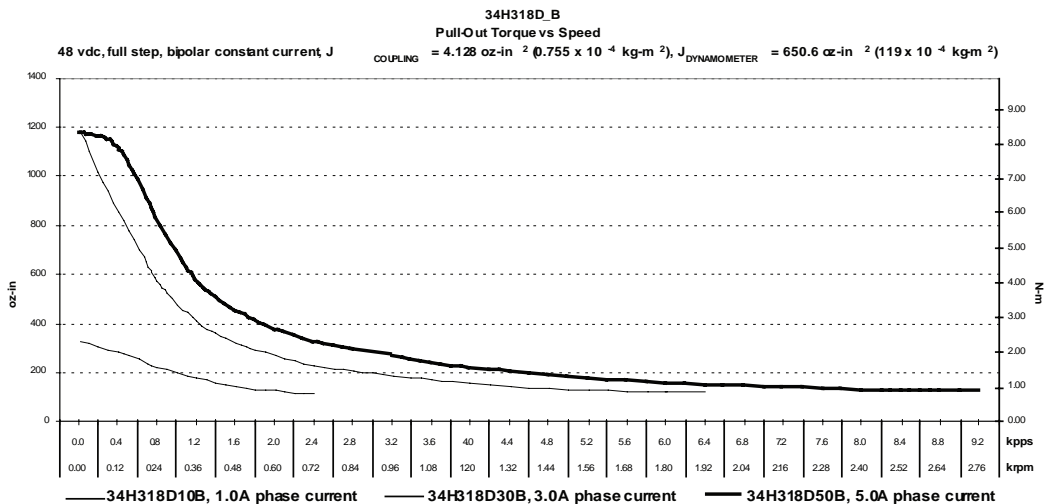
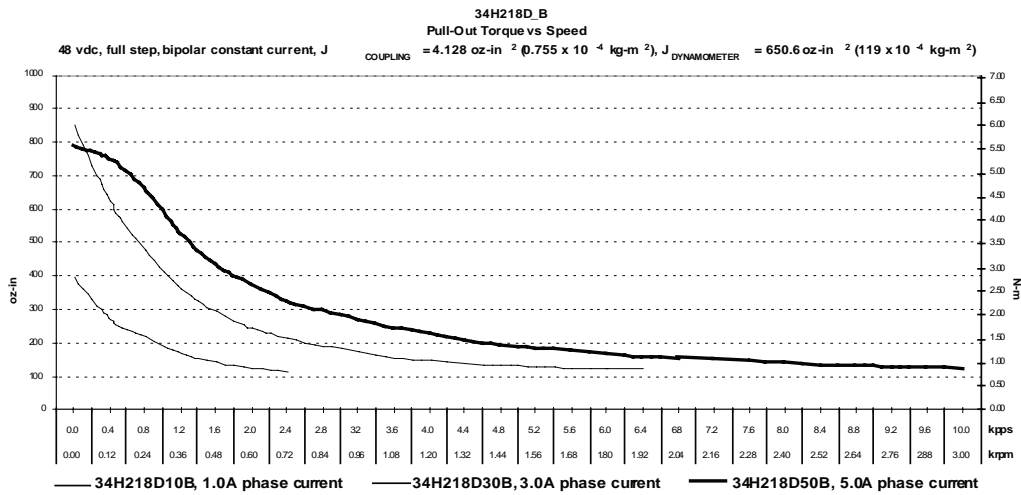
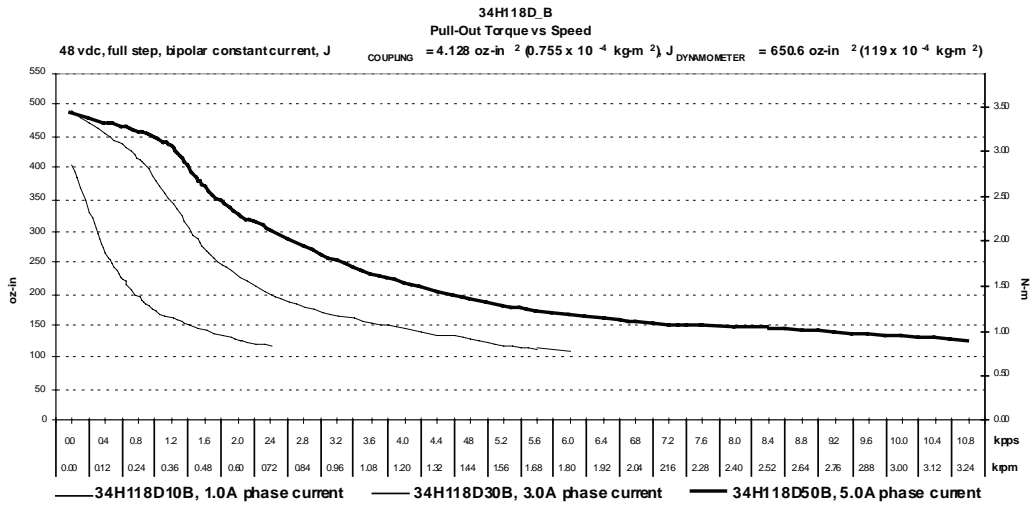

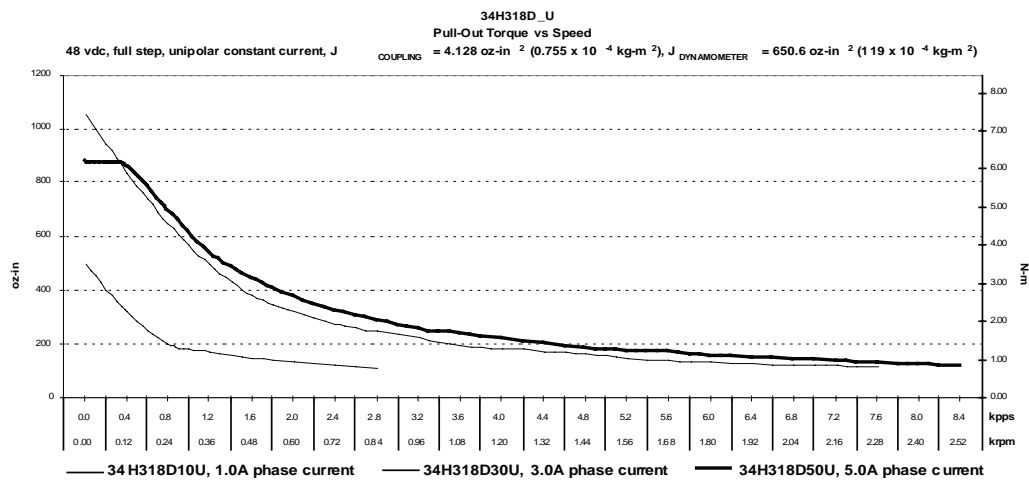
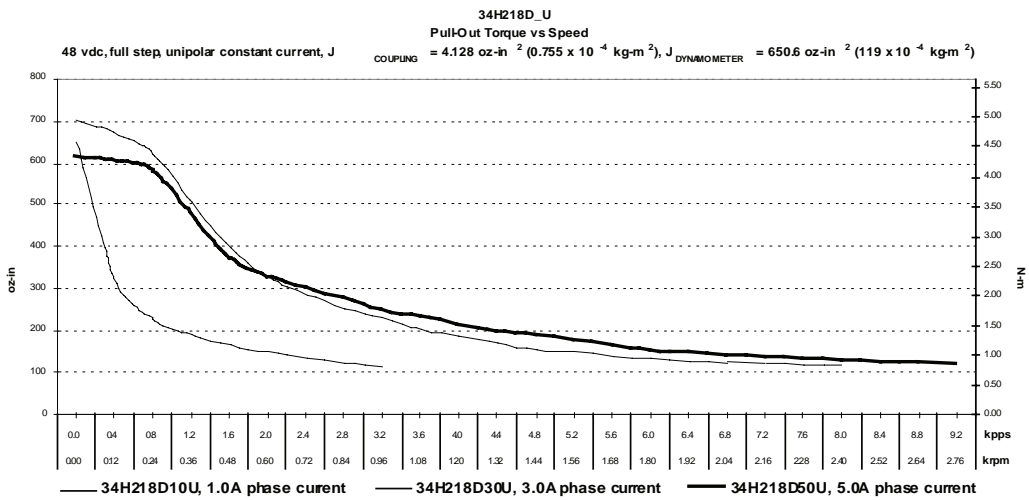
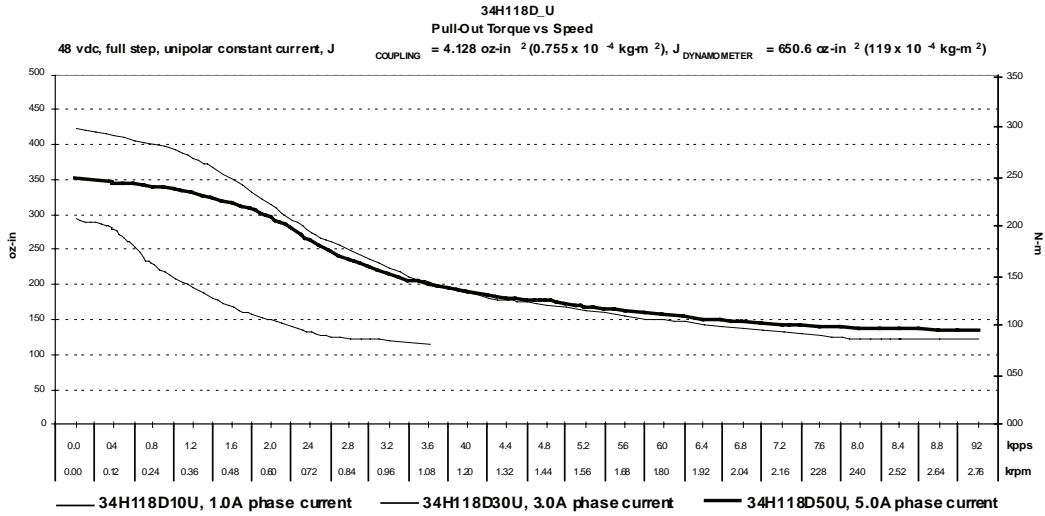

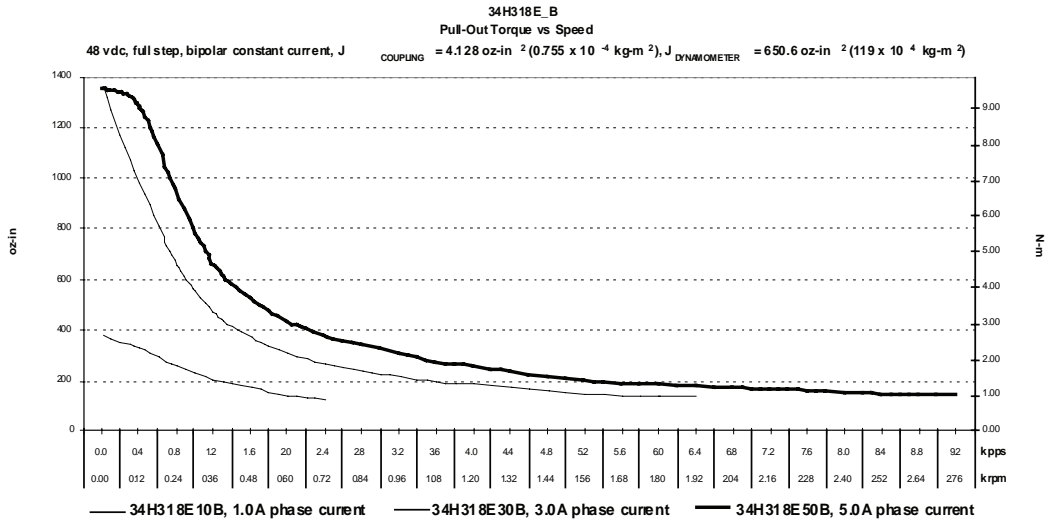
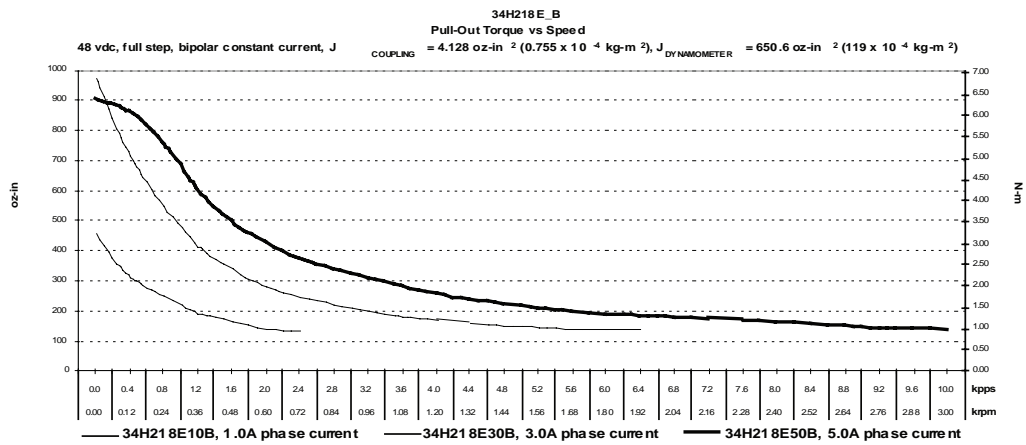
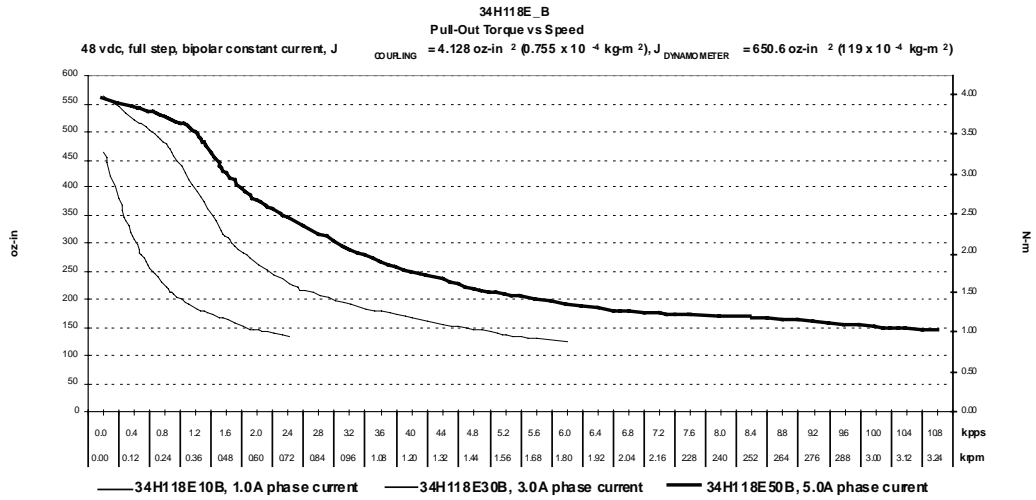

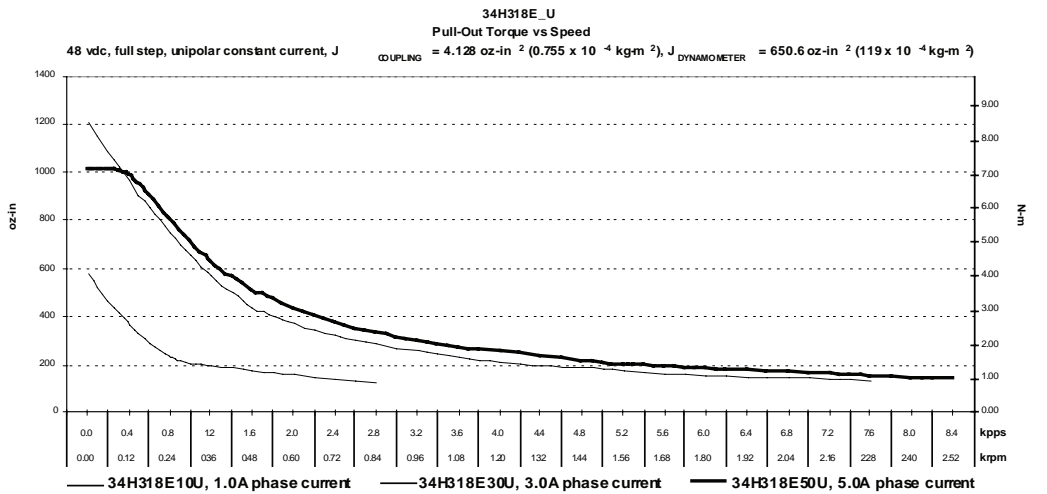
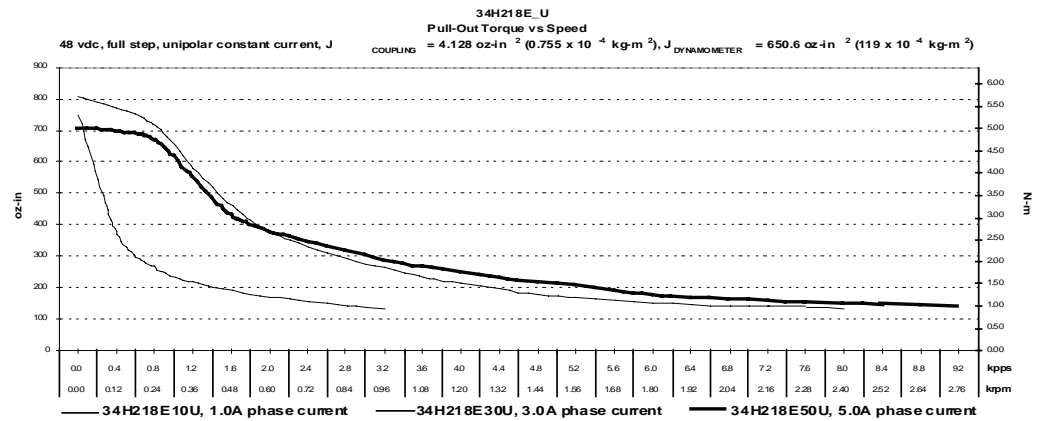
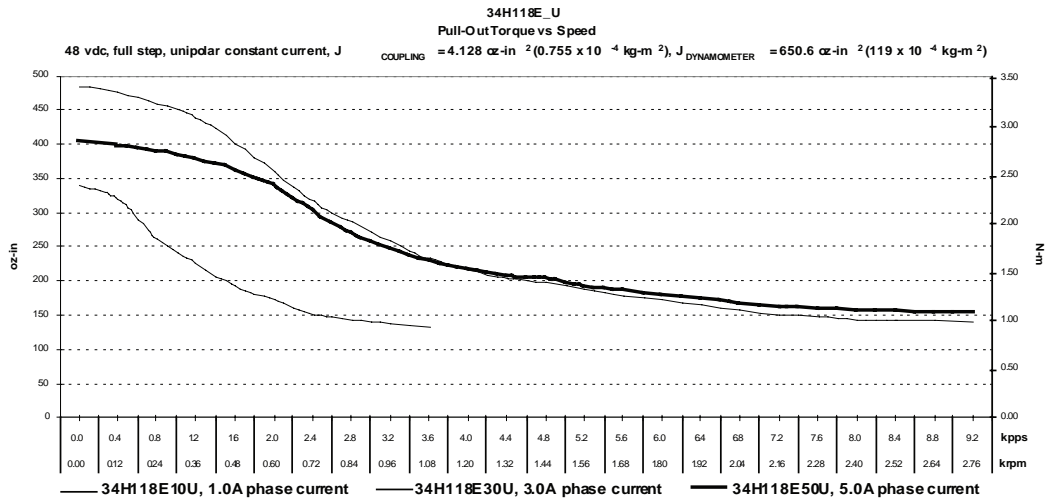

Stepper