

## Table of Contents

Introduction	Page	Page
Raceway Solutions for Total Flexibility .....	ii-v	
<b>1 2 3 4</b> Faceplate Options .....	vi	
Manufacturers' Module Frame Cross Reference.....	vii	
<b>PAN-POLE™</b> Power & Communication Pole .....	viii	<b>PAN-WAY</b> Type PD Surface Raceway Base & Cover .....D7
<b>FIBER-DUCT™</b> Routing System.....	viii	<b>PAN-WAY</b> Type PD Raceway Fittings .....D8
Tips for Selecting a Surface Raceway .....	ix	Fill Capacities for Electrical, UTP and STP Cables .....D9
Fiber Optic Specification Compliant Features.....	x-xi	Fill Capacities for Coax and Fiber Optic Cables .....D10
The Preferred Options .....	xii	
<b>Surface Raceway Products</b>		
<b>PAN-WAY™ Faceplates and Electrical Outlets</b>		
<b>PAN-WAY</b> Snap-On Electrical/Communication Faceplates.....	A3	
<b>PAN-WAY</b> U.S. Standard Screw-On Electrical/Communication Faceplates.....	A3	
<b>PAN-WAY</b> Stainless Steel U.S. Standard Screw-On Electrical/Communication Faceplates .....	A4	
<b>PAN-WAY</b> U.S. Standard Electrical Outlets.....	A4	
<b>PAN-WAY</b> 20A Low Profile Surface Mount Outlet Box with 20A Electrical Outlet .....	A4	
<b>PAN-WAY</b> Brazilian Standard Electrical Faceplates .....	A5	
<b>PAN-WAY</b> French Standard 45X45mm Snap-On Faceplate .....	A5	
<b>PAN-WAY</b> German Schuko and French/Belgium Electrical Outlets and Faceplates.....	A6	
<b>PAN-WAY</b> DIN Standard Two-Piece Surface Mount Outlet Box.....	A6	
<b>PAN-WAY</b> Faceplates and Brackets for Italian Type Electrical Outlets .....	A6	
<b>PAN-WAY</b> Australian Type Screw-On Electrical Outlet .....	A7	
<b>PAN-WAY</b> UK Style Electrical Modules and Faceplates .....	A7	
<b>PAN-WAY Type T-70 &amp; Twin-70 Non-Metallic Surface Raceways</b>		
<b>PAN-WAY</b> T-70 & Twin-70 Non-Metallic Raceways—Roadmaps.....	B3	
<b>PAN-WAY</b> Type T-70 Surface Raceway Configurations .....	B4-B5	
<b>PAN-WAY</b> Type T-70 Surface Raceway System Features .....	B6	
<b>PAN-WAY</b> Type T-70 Surface Raceway Base & Cover .....	B7	
<b>PAN-WAY</b> Type T-70 Fittings.....	B7-B8	
<b>PAN-WAY WORKSTATION OUTLET CENTER™</b>		
Offset Box.....	B8	
<b>PAN-WAY</b> Type T-70 Fill Capacities for Electrical, UTP and STP Cables.....	B10	
<b>PAN-WAY</b> Type T-70 Fill Capacities for Coax and Fiber Optic Cables.....	B11	
<b>PAN-WAY</b> Type Twin-70 Surface Raceway Configurations.....	B12-B13	
<b>PAN-WAY</b> Type Twin-70 Surface Raceway System Features .....	B14	
<b>PAN-WAY</b> Type Twin-70 Surface Raceway Base & Cover .....	B15	
<b>PAN-WAY</b> Type Twin-70 Fittings .....	B16	
<b>PAN-WAY</b> Type Twin-70 Fill Capacities for Electrical, UTP and STP Cables.....	B18	
<b>PAN-WAY</b> Type Twin-70 Fill Capacities for Coax and Fiber Optic Cables.....	B19	
<b>PAN-WAY</b> Type T-70 & Twin-70 Raceway Accessories.....	B20	
T-70 Snap-On Fiber Spool Bracket .....	B20	
<b>PAN-WAY LD Profile Surface Raceway Systems</b>		
<b>PAN-WAY</b> LD Profile Non-Metallic Raceways <b>Data Only</b> —Roadmaps.....	C3	
<b>PAN-WAY</b> LD Profile Non-Metallic Raceways <b>Power Only</b> —Roadmaps .....	C4	
<b>PAN-WAY</b> LD Profile Non-Metallic Raceways Multichannel <b>Data &amp; Power</b> —Roadmap.....	C5	
<b>PAN-WAY</b> LD Profile Raceway Configurations .....	C6-C7	
<b>PAN-WAY</b> LD Profile Raceways—System Features.....	C8-C9	
<b>PAN-WAY</b> Type LDP Surface Raceway.....	C10	
<b>PAN-WAY</b> Type LDS Surface Raceway.....	C11	
<b>PAN-WAY</b> Type LD Surface Raceway .....	C12	
<b>PAN-WAY</b> Type CD Surface Raceway .....	C13	
Standard Fittings for Low Voltage Applications .....	C14	
1" Bend Radius Fittings for TIA/EIA Compliance .....	C14	
Power Rated Fittings for Power to 600V.....	C15	
<b>PAN-WAY</b> Type LD2P Multi-Channel Surface Raceway .....	C16	
Multi-Channel Fittings for Multi-Channel Power & Low Voltage Applications .....	C16	
Fill Capacities for LD Profile Raceways .....	C17-C18	
<b>PAN-WAY Type PD Surface Raceway System</b>		
<b>PAN-WAY</b> Type PD Raceways—Roadmaps.....	D3	
<b>PAN-WAY</b> Type PD Profile Raceway Configurations.....	D4-D5	
<b>PAN-WAY</b> Type PD Profile Raceways—System Features .....	D6	
		<b>PAN-WAY</b> Type TE-70 Non-Metallic Surface Raceway
		<b>PAN-WAY</b> Type TE-70 Non-Metallic Raceway—Roadmap.....
		<b>PAN-WAY</b> Type TE-70 Raceway Configurations.....
		<b>PAN-WAY</b> Type TE-70 Surface Raceway Base & Cover.....
		<b>PAN-WAY</b> Type TE-70 Fittings .....
		<b>PAN-WAY</b> Type TE-70 Accessories .....
		Fill Capacities for Electrical, UTP and STP Cables .....
		Fill Capacities for Coax and Fiber Optic Cables .....
		<b>PAN-WAY Type T Surface Raceway System</b>
		<b>PAN-WAY</b> Type T Raceway—Roadmap .....
		<b>PAN-WAY</b> Type T Raceway Configurations .....
		<b>PAN-WAY</b> Type T Surface Raceway Applications .....
		<b>PAN-WAY</b> Type T Surface Raceway and Accessories .....
		<b>PAN-WAY</b> Type T Raceway Fittings.....
		<b>PAN-WAY</b> Type T Box & Pre-Cut Cover (for NEMA Faceplates).....
		<b>PAN-WAY</b> Type T Snap-On Faceplate Pre-Cut Covers for <b>MINI-COM®</b> Snap-On Modular Furniture Faceplates).....
		<b>PAN-WAY</b> Type T130 Hanging Device Bracket & Molded Covers .....
		Fill Capacities for Electrical, UTP and STP Cables .....
		Fill Capacities for Coax and Fiber Optic Cables .....
		<b>PAN-WAY Surface Raceway System Accessories</b>
		<b>PAN-WAY</b> Surface Raceway Cutting Tool.....
		Floor Guard and Magnet Strip .....
<b>Open Office Products</b>		
<b>PAN-POLE™ Outlet Pole Components</b>		
		<b>PAN-POLE</b> Aluminum Outlet Pole—Roadmap .....
		<b>PAN-POLE</b> Aluminum Outlet Pole Configurations .....
		<b>PAN-POLE</b> Aluminum Outlet Pole Components .....
		<b>PAN-POLE</b> Accessories.....
		Standard Included Mounting Hardware .....
		Installation Instructions .....
		Fill Capacities for Electrical, UTP and STP Cables .....
		Fill Capacities for Coax and Fiber Optic Cables .....
<b>Telecommunication Equipment Room Products</b>		
<b>FIBER-DUCT™ Routing System</b>		
		<b>PANDUCT®</b> Solid and Slotted Wall Wiring Duct.....
		<b>FIBER-DUCT</b> System Fittings .....
		Transition Fittings, Mounting Brackets and Accessories .....
		Fiber Optic Adhesive Markers.....
		Fill Capacities for <b>PANDUCT</b> Type E or Type S .....
<b>PAN-WAY Technical Information</b>		
		NEW TIA/EIA 569-A Requirements for Surface Raceway.....
		NEW UL-5A Standard Explanation.....
		CSA 22.2 Standard Explanation .....
		NEC Article 352B Standard Explanation .....
		Mounting Guidelines & Flammability .....
		Material Physical Properties .....
		Raceway Typical Specifications .....
		Alphabetical Part Number Index .....

**Refer to back cover for information regarding Panduit's complete line of structured cabling products.**

**The PAN-WAY™ Line**

The universal non-metallic surface raceway and surface mount outlet box line that accommodates communication outlets made by most manufacturers and that also accommodates all standard U.S. Electrical outlets and a number of international electrical outlets.

**The method of choice for Data-Com installations!**

Non-metallic surface raceway has become the method of choice for Data-Com installations because of its many advantages:

- Low installed cost
- High density of outlets
- Accessibility
- Ease of modifications and additions
- Bend radius control
- Good appearance

**Applications Include (but not limited to):**

- |                            |                          |                            |
|----------------------------|--------------------------|----------------------------|
| • schools and universities | • training centers       | • manufacturing facilities |
| • office environments      | • libraries              |                            |
| • laboratories             | • customer service areas |                            |

**Solutions for “total flexibility”**

Other raceway systems use non-standard faceplates or frames designed to tie in a specific proprietary connectivity solution, limiting your connectivity choice. Panduit Raceway Systems are designed around NEMA (70mm) Standard Faceplates, the same faceplates used for in-wall applications. This provides you “total flexibility” when making your connectivity choice.



**NEMA Standard Solutions**

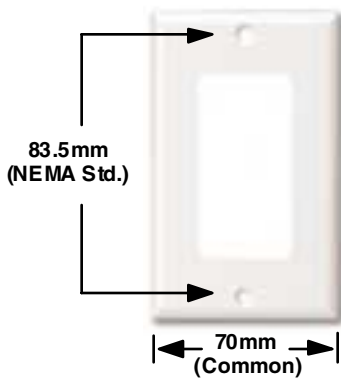

Standard solutions use electrical and communication outlets and faceplates that meet the required NEMA (70mm) standard. They are universal because every U.S. Manufacturer must meet this standard to provide in-wall outlets and faceplates.

U.S. Electrical faceplates have been made to NEMA (70mm) specifications for years. Data-Com faceplates for the U.S. typically match the U.S. Electrical faceplates in size and appearance. In addition, most Data-Com manufacturers provide module frames which adapt standard NEMA (70mm) electrical faceplates to mount their communications modules.

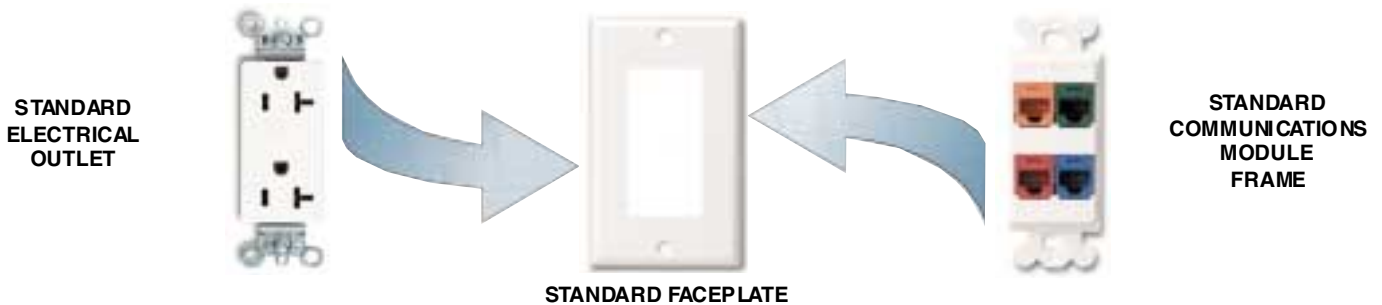

**Global Electrical Outlet Solutions**

Data-Com is common worldwide, however, electrical outlets and faceplates are not (i.e. standards vary). This problem has been solved by the **PAN-WAY™** line which provides international electrical outlets in faceplates that match the U.S. Electrical and Data-Com faceplates in size and appearance. The result is that the **PAN-WAY** line is universal in the U.S. and internationally. (Note: A **WORKSTATION OUTLET CENTER™** offset box is required for German outlets). It can also be used for the installation of Data-Com modules from virtually any source.

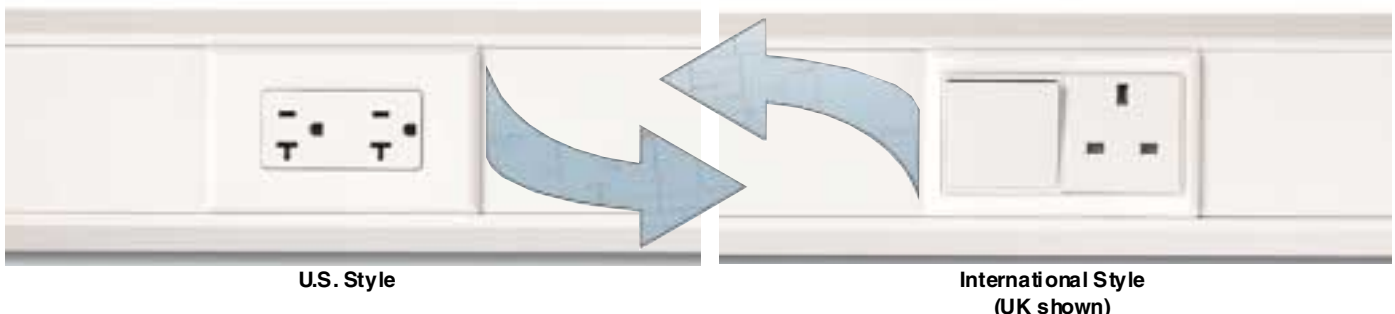

For Technical Assistance, call: 888-506-5400, Ext. 8287 (outside the U.S., see inside back cover for International Directory)

## Faceplates

Various **PAN-WAY™** surface raceways and surface mount outlet boxes and **PAN-POLE™** Outlet Poles accommodate the following faceplates:

### 1. PAN-WAY Snap-On Electrical/Communication Faceplates





These match standard NEMA (70mm) faceplates, however, they snap-on instead of screw-on.

The electrical faceplates accommodate standard NEMA (70mm) 106 and rectangular duplex electrical outlets.

These same faceplates accommodate communication outlets made by most manufacturers when used in conjunction with module frames which they provide to adapt their communication outlets to standard faceplates.



The module frame is screw mounted to the box or raceway mounting frame and this faceplate is snapped over it.

PAN-WAY Snap-On Faceplates	PAN-WAY Electrical Outlets	Communication Module Frames
 <p>See <a href="#">page A3</a></p>	 <p>See <a href="#">page A4</a></p>	 <p>See <a href="#">page vii</a> for list of compatible frames</p>

### 2. PAN-WAY Snap-On Communication Faceplates with Screw Holes to Mount a Module Frame



These are identical to **PAN-WAY** Snap-On Electrical/Communication faceplates, however, they have screw holes to mount any manufacturers' module frames to these faceplates which eliminates the need for mounting frames for certain raceway applications such as T-70 and Twin-70.

PAN-WAY Snap-On Faceplates	Communication Module Frames
 <p>with Screw Holes</p> <p>See <a href="#">page A3</a></p>	 <p>See <a href="#">page vii</a> for list of compatible frames</p>



### 3. U.S. Standard Screw-On Electrical/Communication Faceplates



Standard electrical/communication faceplates match standard NEMA (70mm) faceplates. These accommodate all the same electrical and/or communication outlets and module frames as **PAN-WAY** Snap-On Faceplates.

Some **PAN-WAY** surface mount outlet boxes accommodate only screw-on faceplates. **PAN-WAY** screw-on electrical/communication faceplates match **PAN-WAY** Snap-On electrical/communication faceplates in appearance and are recommended for such applications.

Most Data-Com manufacturers supply NEMA (70mm) standard screw-on faceplates and they can be used anywhere **PAN-WAY** snap-on or screw-on electrical/communication faceplates are used.

PAN-WAY Screw-On Faceplates	PAN-WAY Electrical Outlets	Communication Module Frames
 <p>See <a href="#">page A3</a></p>	 <p>See <a href="#">page A4</a></p>	 <p>See <a href="#">page vii</a> for list of compatible frames</p>

**4. U.S. Standard Screw-On Communication Faceplates**



Standard communication faceplates that match standard NEMA (70mm) faceplates are supplied by any manufacturer for their communication modules. These include **PAN-NET™** and **PAN-WAY™** Communication Products Screw-On communication faceplates made by Panduit.

**PAN-WAY Screw-On Communication Faceplates for Panduit PAN-NET Modules**



Other styles available

**5. Panduit® Snap-On Communication Faceplates**



**PAN-NET** style snap-on faceplates accommodate communication modules made by Panduit without the need for module frames.

**PAN-WAY** Communication Products style snap-on faceplates accommodate communication modules made by Panduit without the need for module frames.

**Snap-On Communications Faceplates for Panduit PAN-NET and PAN-WAY Communication Modules**



NOTE: Refer to **PAN-NET** Communication Catalog (SA101N152E-OP) for information on our complete line of **PAN-NET** Faceplates and Modules. **PAN-WAY** General Purpose Standard "Keystone" Communication Modules and Faceplates (SA101N435-OP—Available 4th Quarter 1999).

**6. International Faceplates**



In addition to the above, Panduit provides:

Electrical faceplates and international electrical outlets that match the NEMA (70mm) faceplates in size and appearance and mount on various **PAN-WAY** surface raceways and surface mount outlet boxes.

**PAN-WAY International Faceplates**



Brazil

France

Italy

UK

Australia











Germany

See [page A5](#) thru [AZ](#)

**Faceplates**

Various **PAN-WAY™** surface raceways, surface mount outlet boxes and **PAN-POLE™** Outlet Poles accommodate the following faceplates:

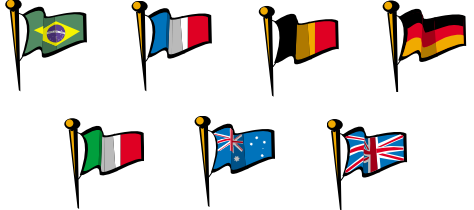

PAN-WAY™ PLASTIC SURFACE RACEWAY

Faceplate	Description	Works With	
<b>PAN-WAY Snap-On Electrical/Communication Faceplates</b>			
<p><b>1</b></p> 	<ul style="list-style-type: none"> <li>Accommodate electrical/communication outlets</li> <li>Snap over outlet or module frame when mounted to a raceway channel or a <b>FAST-SNAP™</b> Surface Mount Outlet Box</li> </ul>	 <p>Most Mfg. Standard Electrical Outlets</p>	 <p>Most Mfg. Communication Module Frames</p> <p>See Column A or B next page</p>
<b>PAN-WAY Snap-On Communication Faceplates (with screw holes to mount a module frame)</b>			
<p><b>2</b></p> 	<ul style="list-style-type: none"> <li>Accommodate communication outlets</li> <li>Outlet attaches <b>directly</b> to faceplate which snaps on a raceway channel or on a <b>FAST-SNAP</b> Surface Mount Outlet Box</li> </ul>	 <p>Most Manufacturers' Communication Module Frames</p> <p>See Column A or B next page</p>	
<b>PAN-WAY U.S. Standard Screw-On Electrical/Communication Faceplates</b>			
<p><b>3</b></p> 	<ul style="list-style-type: none"> <li>Accommodate electrical/communication outlets</li> <li>Screw mount over outlet or module frame when mounted to a surface mount outlet box or raceway mounting bracket or box</li> </ul>	 <p>Most Mfg. Standard Electrical Outlets</p>	 <p>Most Mfg. Communication Module Frames</p> <p>See Column A or B next page</p>
<b>U.S. Standard Screw-On Communication Faceplates</b>			
<p><b>4</b></p> 	<ul style="list-style-type: none"> <li>Standard communication faceplates that match standard NEMA (70mm) Faceplates supplied by any manufacturer for their communication modules</li> <li>These include <b>PAN-NET</b> and <b>PAN-WAY™</b> Screw-On Communication Faceplates made by Panduit</li> </ul>	<p>Standard Manufacturers' Faceplate &amp; Modules</p>	
<b>PAN-WAY International Electrical Faceplates</b>			
	<ul style="list-style-type: none"> <li>Electrical faceplates and international electrical outlets that match the NEMA (70mm) Faceplates in size and appearance and mount on various <b>PAN-WAY</b> Surface Raceways and Surface Mount Outlet Boxes</li> </ul>	 <p>See <a href="#">page A5</a> thru <a href="#">A7</a></p>	

NOTE: See the "configuration pages" in each section of this catalog for detailed information on how to complete a termination using the solutions shown above.

**Communication Module Frames Compatible with *PAN-WAY*™  
Electrical/Communication Faceplates for *PAN-WAY* Surface  
Raceway and *PAN-POLE*™ Outlet Poles**

**Panduit® and Other Manufacturers' Module Frame Part Numbers**

MANUFACTURER	A	B
	 <b>Module Frames for use with 106 Style Electrical/Communication Faceplates</b>	 <b>Module Frames for use with Rectangular Electrical/Communication Faceplates</b>
<b>Panduit <i>PAN-NET</i></b>	CF1064**	CFG 1**, CFG2**, CFG4**
<b>Lucent Technologies</b>	M106FR2, M106FR4	M108FR3
<b>Amp</b>	558302-*	558321-*
<b>Hubbell</b>	106 DUPLEX SERIES: BR106*, BR106***	STYLELINE SERIES: FSL244*, FSL244**, FSL344*, FSL344**
<b>Krone</b>	6644 1 106-** 6644 1 107-**	N/A
<b>Leviton</b>	41070-***, 41071-***, 41072-***, 41087-***	40850**, 41642-*, 41666-*, 41688-*, 41658-*, 41668-*
<b>Mod-Tap</b>	11.B008, 11.B029	11.B034, 11.B030
<b>Nordx/CDT</b>	MDVO 106 Adapters: NXMAA2-0* (AX10030*) NXMAA4-0* (AX10031*)	MDVO Deco Adapter: QNE4AG(10*)(A040965*)
<b>Ortronics</b>	OR-62850001-**, OR-62850002-**, up to OR-62850024-**	OR-63650001-**, OR-63650002-**, up to OR-63650024-**
<b>Siemon</b>	MX-E2A-**, MX-E2F-**, MX-E4A-**, MX-E4F-**	MX-D1-**, MX-D2-**, MX-D4-**

Contact Panduit for other manufacturers not shown above.  
 “\*” Designates a color option.

***PAN-WAY*** Electrical/Communication Faceplates are compatible with the current design of all of the frames listed; however, it is the customer’s responsibility to confirm the current suitability of any particular faceplate/frame combination.

***PAN-WAY*™ PLASTIC SURFACE RACEWAY**



**The *PAN-POLE™* Outlet Pole Line**

Accepts the same 70mm cover as surface raceway. Aluminum Outlet Poles for power and communications in an open office environment. These accommodate the same power and communication outlets and faceplates as the *PAN-WAY™* line, however, compliance with local specifications must be checked for international installations.

**The *FIBER-DUCT™* Routing System**

For routing cabling to and from racks and other cable managers within the closet, Panduit features the *FIBER-DUCT* Routing System. The system has two sizes, 2" x 2" and 4" x 4" with fittings that maintain a minimum 2" bend radius. The product is available in a number of colors to code the type of cable being routed. There is a full line of mounting brackets available.





## Tips for Selecting a Surface Raceway

How to select a **PAN-WAY™** Surface Raceway:

### 1. Determine the cabling systems to be routed: Data Only, Power Only or Both Power & Data

Low Voltage (Data) Raceway Systems
Any <b>PAN-WAY</b> Surface Raceway System can be used for routing low voltage cabling, however if some cables have bend radius limitations the proper raceway fittings must be used.

Power Rated Raceway Systems
LDP, LD2P, LDS, PD, Twin-70, T-70, T105, T130, T170, T3, TE70

Multichannel Raceway Systems (Route Power & Data)
LD2P, Twin-70, T-70, T105, T130, T170, T3, TE70

### 2. Consider the special requirements of the cable type used:

**UTP Category 5 cabling:** Per the TIA/EIA specification, UTP Category 5 cabling must maintain a cable bend radius of 1" (4 times the cable outside diameter.)

Raceway Systems with 1" Bend Radius Fittings
Twin-70, T-70, any LD Profile raceway using 1" Bend Radius Fittings



The symbol at left is used throughout this catalog to indicate a system fitting that maintains the minimum 1" bend radius for Category 5 and fiber optic cabling.

**Fiber Optic Cabling:** For the special handling requirements of Fiber Optic Cabling see the explanation on the next page.



The Panduit **PAN-WAY** Surface Raceway Systems listed are part of the **FIBER-SPEC™** System optimized for routing fiber optic cabling:

- Twin-70 Raceway System
- T-70 Raceway System
- LDP Raceway System
- LD2P Raceway System

### 3. Compare the cable diameter (s) and number of cables to be routed with the raceway fill capacity tables provided:

These tables are located in the back of each raceway section in this catalog.

**SPEC:** Use this number when specifying a new surface raceway system.

**MAX:** The maximum number of cables that can be accommodated within the specified raceway channel.

Data Grade Cables			
24 AWG UTP CM			
25 pr		Cat. 5 4 pr	
DIA.=0.422		DIA.=0.217	
FILL		FILL	
SPEC	MAX	SPEC	MAX
15	22	56	84

(F70 Cat5 fills)

### 4. Find a Termination Configuration to meet your requirements:

**CONFIGURATIONS**

1

2

3

4

Each section contains a configuration section which calls out the components required to terminate each of the solutions shown in the chart on [page vi](#). Look for the color coded numbers to quickly identify the solution.

## Fiber Optic Cabling

Panduit has identified the following criteria, based on the TIA/EIA standards and good cabling practices, which should be taken into consideration when selecting a raceway system to route fiber optic cabling:



- Must provide security and segregation
- Must provide bend radius protection for the cabling
- Must provide the installer with access to 1 meter of fiber optic cabling

### Must provide security and segregation

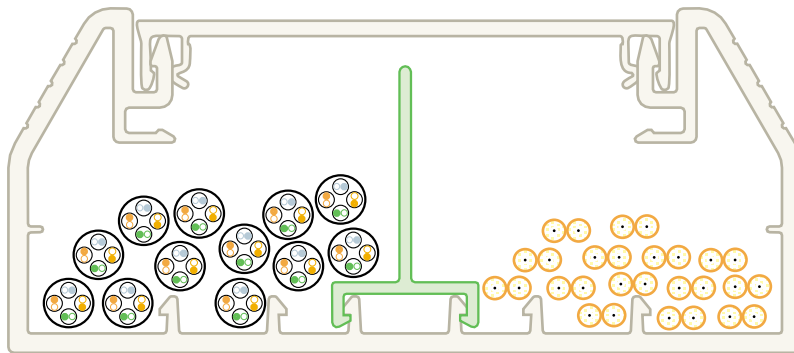

- Installation of divider wall maintains separated security for fiber cables.

### Must provide bend radius protection for the cabling



- Panduit **FIBER-SPEC™** Raceway Systems all maintain minimum 1" bend radius control throughout system.

**Must provide the installer with access to 1 meter of fiber optic cabling**

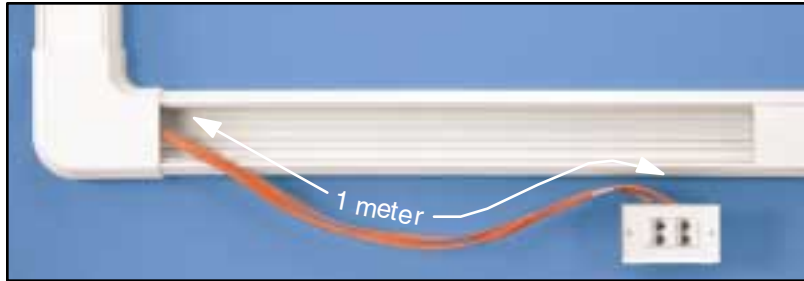

When cover is not installed, length of cable in raceway is removed to provide access.

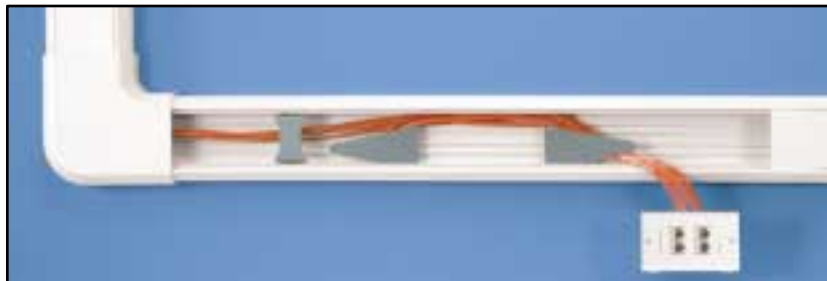

If additional length of cable is desired, bend radius controlled storage loop is installed on base of raceway (see [page B20](#)).

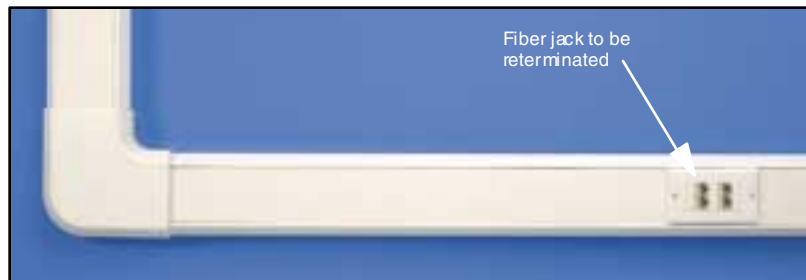

Raceway cover and faceplate are snapped on providing security and segregation.

**NEW**

# THE PREFERRED OPTIONS

Available Only From Panduit®

## Integral Snap-On Faceplates

SNAP-ON to **PAN-WAY™** Surface Raceway and **FAST-SNAP™** Surface Mount Outlet Boxes. Communication modules snap directly into faceplate. Available for Panduit **PAN-NET™** and **PAN-WAY** Communication Modules.

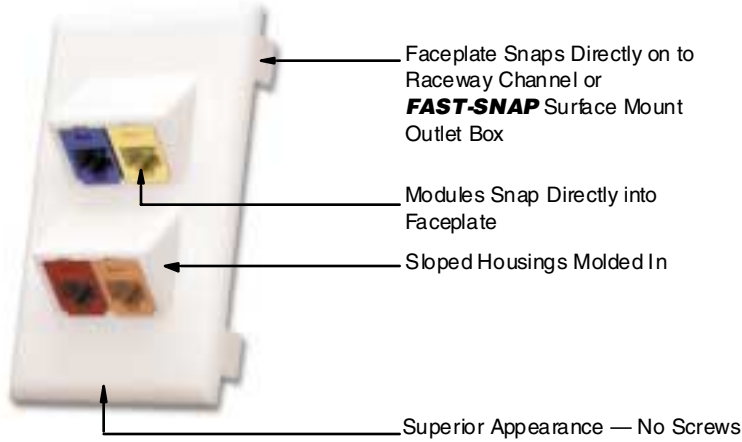

### THE ADVANTAGES



INSERTS ARE NOT REQUIRED



MODULE FRAMES ARE NOT REQUIRED\*



SCREWS ARE NOT REQUIRED



VERSIONS TO ACCEPT **PAN-NET** OR **NEW PAN-WAY** COMMUNICATION MODULES

## Integral Screw-On Faceplates

SCREW-ON to **PAN-WAY** Surface Raceway and **FAST-SNAP** Surface Mount Outlet Boxes. Communication modules snap directly into faceplate. Available for Panduit **PAN-NET** and **PAN-WAY** Communication Modules.

### THE ADVANTAGES



INSERTS ARE NOT REQUIRED



MODULE FRAMES ARE NOT REQUIRED\*

**NEMA STANDARD**

NEMA STANDARD HOLE SPACING AND 70mm WIDTH



VERSIONS TO ACCEPT **PAN-NET** OR **NEW PAN-WAY** COMMUNICATION MODULES

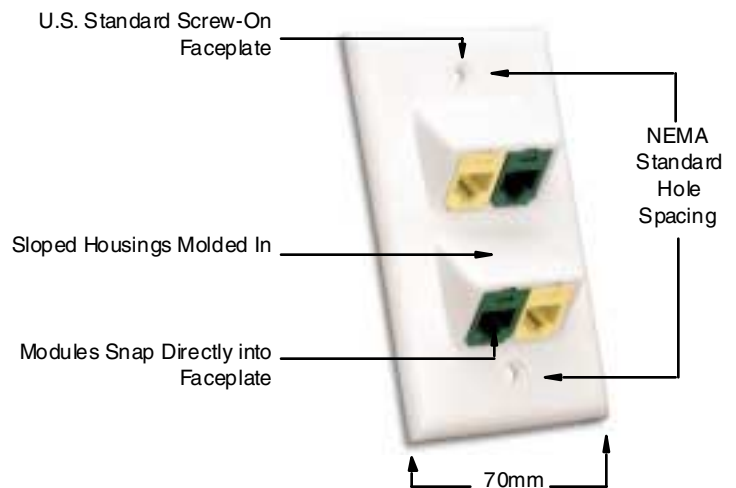

	SEE CATALOG
Panduit <b>PAN-WAY</b> General Purpose Standard “Keystone” Communication Modules and Faceplates (Available 4th quarter)	SA101N435-OP
Panduit <b>PAN-NET</b> Specification Grade Communication Modules and Faceplates	SA101N152E-OP

\*NOTE: Module frames are available for Panduit **PAN-NET** communication modules, however, they are not recommended. Integral snap-on faceplates which are available for these communication modules are a superior solution because no module frame is required and all screws are eliminated.

# NOTES

---

# *Surface Raceway Products*



## **PAN-WAY™** Faceplates and Electrical Outlets

**PAN-WAY** Faceplates and Electrical Outlets are available to mount, conceal and terminate power and communications with **PAN-WAY** Plastic Surface Raceway and surface mount outlet boxes.

All are available in colors to match and complement the raceway and surface mount outlet boxes.

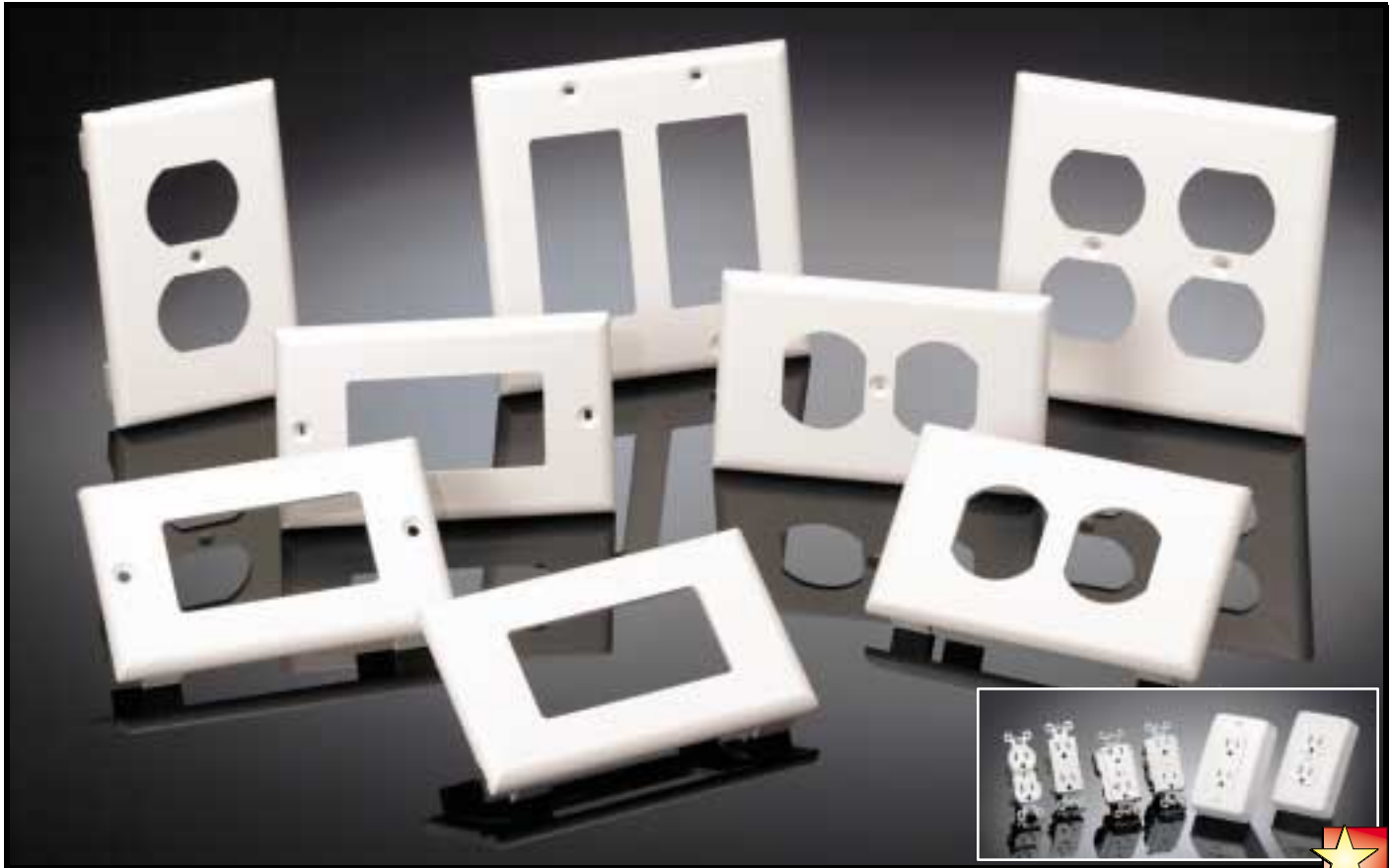

### **Faceplates**

- U.S. Standard Screw-On Electrical/Communication Faceplates
- New **PAN-WAY** Snap-On Faceplates available for electrical/communication applications
- All electrical/communication faceplates are UL 5A Listed to 600V and CSA Certified to 300V
- Available in 4 standard colors
- Select styles available in up to 7 colors

### **Electrical Outlets**

- Standard electrical devices
- Available styles:
  - 20A 106 Duplex
  - 20A Rectangular
  - TVSS Rectangular
  - GFCI Rectangular
- New 20A Low Profile Surface Mount Outlet Boxes include box and 20A outlet
- Available in 2 colors



### **INTERNATIONAL OUTLET SOLUTIONS**

See [page A5](#) thru [A7](#)

For Technical Assistance, call: 888-506-5400, Ext. 8287 (outside the U.S., see inside back cover for International Directory)

**Table of Contents**

Page



**PAN-WAY™ Snap-On Faceplates**

Electrical/Communication Faceplates . . . . . A3  
 Electrical/Communication Faceplates  
 (with screw holes for module frames) . . . . . A3



**PAN-WAY U.S. Standard Screw-On Electrical/Communication Faceplates**

**PAN-WAY** Duplex Screw-On Faceplates . . . . . A3  
**PAN-WAY** Rectangular Screw-On Faceplates . . . . . **A3**  
**PAN-WAY** Stainless Steel Faceplates . . . . . A4



**PAN-WAY Electrical Outlets & Low Profile Outlet Boxes**

20A 106 Duplex and Rectangular Outlets . . . . . A4  
 TVSS Surge Suppression Outlet . . . . . A4  
 GFCI Ground Fault Outlet . . . . . A4  
 20A Low Profile, 106 Duplex and Rectangular . . . . . A4  
 International Outlets . . . . . A5-A7



## PAN-WAY™ Snap-On Electrical/Communication Faceplates



T70P

T70PG

Part Number	Description	Color◆	Std. Pkg. Qty.	Std. Ctn. Qty.
-------------	-------------	--------	----------------	----------------

### Single Gang 106 Duplex Electrical/Communication Snap-On Faceplate

T70PIW	Snap-on faceplate covers one NEMA standard 106 duplex electrical outlet. In communication applications covers one standard 106 communication module frame. <i>No mounting screws required to install faceplate.</i>	Off White	1 pc.	10 pcs.
--------	---------------------------------------------------------------------------------------------------------------------------------------------------------------------------------------------------------------------	-----------	-------	---------

### Single Gang Rectangular Electrical/Communication Snap-On Faceplate

T70PGIW	Snap-on faceplate covers one NEMA standard rectangular electrical outlet. In communication applications covers one rectangular communication module frame. <i>No mounting screws required to install faceplate.</i>	Off White	1 pc.	10 pcs.
---------	---------------------------------------------------------------------------------------------------------------------------------------------------------------------------------------------------------------------	-----------	-------	---------

### Single Gang 106 Duplex Communication Snap-On Faceplate\* (with screw holes to mount a module frame)

T70PSIW	Snap-on faceplate covers one NEMA standard 106 duplex module frame. Module frame screw mounts directly to underside of snap-on faceplate. No device bracket needed. Supplied with one mounting screw.	Off White	1 pc.	10 pcs.
---------	-------------------------------------------------------------------------------------------------------------------------------------------------------------------------------------------------------	-----------	-------	---------

### Single Gang Rectangular Communication Snap-On Faceplate\* (with screw holes to mount a module frame)

T70PGSIW	Snap-on faceplate covers one NEMA standard rectangular communication module frame. Module frame screw mounts directly to underside of snap-on faceplate. No device bracket needed. Supplied with two mounting screws.	Off White	1 pc.	10 pcs.
----------	-----------------------------------------------------------------------------------------------------------------------------------------------------------------------------------------------------------------------	-----------	-------	---------

T70PSIW

T70PGSIW

◆ All parts listed in Off White (IW) color. To order other colors substitute EI (Electric Ivory), IG (Light Gray), and WH (White). Contact factory for details.

#### ORDERING INFORMATION:

Order number of pieces required, in multiples of Standard Package.

\*Not for use with electrical devices



## PAN-WAY U.S. Standard Screw-On Electrical/Communication Faceplates



CP106

CP106\*\*-2G

Part Number	Description	Color◆	Std. Pkg. Qty.	Std. Ctn. Qty.
-------------	-------------	--------	----------------	----------------

### Single Gang 106 Duplex Screw-On Faceplate

CP106IW	Covers one NEMA standard 106 duplex electrical outlet. In communication applications, covers one standard 106 communication module frame. Supplied with one mounting screw.	Off White	1 pc.	10 pcs.
---------	-----------------------------------------------------------------------------------------------------------------------------------------------------------------------------	-----------	-------	---------

### Double Gang 106 Duplex Screw-On Faceplate

CP106IW-2G	Covers two NEMA standard 106 duplex electrical outlets. In communication applications, covers two standard 106 communication module frames. Supplied with two mounting screws.	Off White	1 pc.	10 pcs.
------------	--------------------------------------------------------------------------------------------------------------------------------------------------------------------------------	-----------	-------	---------

### Single Gang Rectangular Screw-On Faceplate

CPGIW	Covers one NEMA standard rectangular electrical outlet. In communication applications, covers one standard rectangular communication module frame. Supplied with two mounting screws.	Off White	1 pc.	10 pcs.
-------	---------------------------------------------------------------------------------------------------------------------------------------------------------------------------------------	-----------	-------	---------

### Double Gang Rectangular Screw-On Faceplate

CPGIW-2G	Covers two NEMA standard rectangular electrical outlets. In communication applications, covers two standard rectangular communication module frames. Supplied with four mounting screws.	Off White	1 pc.	10 pcs.
----------	------------------------------------------------------------------------------------------------------------------------------------------------------------------------------------------	-----------	-------	---------

CPG

CPG\*\*-2G

◆ All parts listed in Off White (IW) color. To order other colors substitute EI (Electric Ivory), IG (Light Gray), WH (White), RD (Red), BR (Brown) and BL (Black). Contact factory for details.

#### ORDERING INFORMATION:

Order number of pieces required, in multiples of Standard Package.

**PAN-WAY™ Stainless Steel U.S. Standard Screw-On Electrical/Communication Faceplates**



WPS-20



WPS-202

Part Number	Description	Color	Std. Pkg Qty.	Std. Ctn. Qty.
<b>Single Gang 106 Duplex Stainless Steel Faceplate</b>				
WPS-20	Covers one NEMA standard 106 duplex electrical outlet. In communication applications covers one standard 106 communication module frame. Supplied with one mounting screw.	—	1 pc.	10 pcs.
<b>Double Gang 106 Duplex Stainless Steel Faceplate</b>				
WPS-202	Covers two NEMA standard 106 duplex electrical outlets. In communications applications covers two standard 106 module frames. Supplied with two mounting screws.	—	1 pc.	10 pcs.

**ORDERING INFORMATION:**

Order number of pieces required, in multiples of Standard Package.

**PAN-WAY U.S. Standard Electrical Outlets**

Compatible with all **PAN-WAY** Surface Raceway and Surface Mount Outlet Boxes



NEW!



EDU20\*\*-X



NEW!



ERU20\*\*-X



NEW!



ETU20IW-X



NEW!



EGU20IW-X

Part Number	Description	Color♦	Std. Pkg. Qty.	Std. Ctn. Qty.
<b>106 Duplex Electrical Outlet</b>				
EDU20IW-X	20A U.S. style 106 duplex outlet. Supplied with two mounting screws.	Off White	10 pc.	100 pcs.
<b>Rectangular Electrical Outlet</b>				
ERU20IW-X	20A U.S. style rectangular outlet. Supplied with two mounting screws.	Off White	10 pc.	100 pcs.
<b>Rectangular Transient Voltage Surge Suppression Electrical Outlet</b>				
ETU20IW-X	20A TVSS rectangular outlet. Supplied with two mounting screws.	Off White	1 pc.	10 pcs.
<b>Rectangular Ground Fault Circuit Interrupt Electrical Outlet</b>				
EGU20IW-X	20A GFCI rectangular outlet. Supplied with two mounting screws.	Off White	1 pc.	10 pcs.
106 duplex and rectangular style outlets fit into surface mount outlet boxes, and are compatible with all <b>PAN-WAY</b> Surface Raceways.				

♦ All parts listed in Off White color (IW). For Electrical Ivory substitute (EI).

**ORDERING INFORMATION:**

Order number of pieces required, in multiples of Standard Package.

**PAN-WAY™ Surface Mount Outlet Box with 20A Electrical Outlet**



NEW!



JBP1MR20



NEW!



JBP1MD20



Part Number	Description	Color♦	Std. Pkg. Qty.	Std. Ctn. Qty.
<b>Surface Mount Outlet Box with 20A Rectangular Electrical Outlet</b>				
JBP1MR20IW	Two-piece power rated Low Profile Surface Mount Outlet Box. Supplied with 20A U.S. style rectangular electrical outlet.	Off White	1 pc.	10 pcs.
<b>Surface Mount Outlet Box with 20A 106 Duplex Electrical Outlet</b>				
JBP1MD20IW	Two-piece power rated Low Profile Surface Mount Outlet Box. Supplied with 20A U.S. style 106 duplex electrical outlet.	Off White	1 pc.	10 pcs.

♦ All parts listed in Off White color (IW). For Electrical Ivory substitute (EI).

**ORDERING INFORMATION:**

Order number of pieces required, in multiples of Standard Package.

**NOTE:** See Selection Chart on [page E6](#) for detailed information on specific usage with raceways.



## PAN-WAY™ Brazilian Standard Electrical Faceplates



**NEW!**



T70PB



FP1B



FP2BB

Part Number	Description	Color	Std. Pkg. Qty.	Std. Ctn. Qty.
<b>Single Gang Snap-On Electrical Faceplate</b>				
T70PBIW	Covers one Brazilian electrical outlet. No screws required to mount faceplate.	Off White	1 pc.	10 pcs.
<b>Single Gang Screw-On Electrical Faceplate</b>				
FP1BIW	Covers one Brazilian electrical outlet. Supplied with two mounting screws.	Off White	1 pc.	10 pcs.
<b>Double Gang Screw-On Electrical Faceplate</b>				
FP2BBIW	Covers two Brazilian electrical outlets. Supplied with two mounting screws.	Off White	1 pc.	10 pcs.

◆ All parts listed in Off White (IW) color. To order other colors substitute EI (Electric Ivory), IG (Light Gray), and WH (White). Contact factory for details.

**ORDERING INFORMATION:**

Order number of pieces required, in multiples of Standard Package.



## PAN-WAY French Standard 45X45 Snap-On Faceplate



T70BL2

Part Number	Description	Color	Std. Pkg. Qty.	Std. Ctn. Qty.
<b>45X45mm Snap-On Electrical/Communication Faceplate (accepts 45X45 modules)</b>				
T70BL2IW	Single gang snap-on electrical/communication faceplate accepts two (2) 45x45mm French power outlet modules or four (4) half size modules.	Off White	1 pc.	10 pcs.

◆ All parts listed in Off White (IW) color. To order other colors substitute EI (Electric Ivory), IG (Light Gray), and WH (White). Contact factory for details.

**ORDERING INFORMATION:**

Order number of pieces required, in multiples of Standard Package.



**PAN-WAY™ German Schuko and French/Belgium Electrical Outlets and Faceplates**



EID16

EIF16

ESD10



FCFP1P

Part Number	Description	Color◆	Std. Pkg. Qty.	Std. Ctn. Qty.
<b>German Schuko Style Electrical Outlet</b>				
EID16AW-X	16A Schuko style outlet. 55mm x 55mm.	Arctic White	10 pcs.	100pcs.
<b>French/Belgium Style Electrical Outlet</b>				
EIF16AW-X	16A French/Belgium style outlet. 55mm x 55mm.	Arctic White	10 pcs.	100pcs.
<b>Double Pole Switch</b>				
ESD10AW-X	10A double pole switch	Arctic White	10 pcs.	100pcs.
<b>Single Gang Faceplate for German Schuko and French/Belgium Standard Electrical Outlets</b>				
FCFP1PAW-X	Single gang faceplate for 55mm x 55mm electrical outlet or switch.	Arctic White	10 pcs.	100pcs.

◆ All parts listed in Arctic White (AW) color. To order other colors substitute IW (Off White) or IG (Light Gray). Contact factory for details.

**ORDERING INFORMATION:**

Order number of pieces required, in multiples of Standard Package.



**PAN-WAY DIN Standard Two-Piece Surface Mount Outlet Box**



DJBX

Part Number	Description	Color◆	Std. Pkg. Qty.	Std. Ctn. Qty.
<b>Two-Piece DIN Box</b>				
DJBXAW	Single gang DIN box — base and cover. Conduit breakouts: 25mm, 19mm, 13mm.	Arctic White	1 pc.	10 pcs.

◆ All parts listed in Arctic White (AW) color. To order other colors substitute IW (Off White) or IG (Light Gray). Contact factory for details.

**ORDERING INFORMATION:**

Order number of pieces required, in multiples of Standard Package.



**PAN-WAY Faceplates and Brackets for Italian Type Electrical Outlets**

For T-70, Twin-70, TE-70



T70MDB-X



T70PM

Part Number	Description	Color◆	Std. Pkg. Qty.	Std. Ctn. Qty.
<b>Mounting Bracket for Italian Type Outlets (for T-70/Twin-70/TE-70 Raceway)*</b>				
T70MDB-X	Bracket accepts VIMAR products (Italy) of the "idea" series. Mounts directly to T-70, Twin-70 or TE-70 raceway.	Gray	10pcs.	100pcs.
<b>Italian Type Snap-On Electrical Faceplate*</b>				
T70PMAW-X	Faceplate snaps over bracket frame to mount to T-70, Twin-70 or TE-70 raceway or <b>FAST-SNAP™</b> Surface Mount Outlet Boxes.	Arctic White	10pcs.	100pcs.

◆ All parts listed in Arctic White (AW) color. To order other colors substitute IW (Off White) or IG (Light Gray). Contact factory for details.

**ORDERING INFORMATION:**

Order number of pieces required, in multiples of Standard Package.

\*Contact Panduit for availability and product offering.



## PAN-WAY™ Australian Type Screw-On Electrical Outlet



EJA15

Part Number	Description	Color	Std. Pkg. Qty.	Std. Ctn. Qty.
-------------	-------------	-------	----------------	----------------

### Australian Type Electrical Outlet\*

EJA15AW-X	15A two gang Australian standard outlet.	Arctic White	10 pcs.	100 pcs.
-----------	------------------------------------------	--------------	---------	----------

◆ All parts listed in Arctic White (AW) color. To order other colors substitute IW (Off White) or IG (Light Gray). Contact factory for details.

#### ORDERING INFORMATION:

Order number of pieces required, in multiples of Standard Package.

\*Contact Panduit for availability and product offering.



## PAN-WAY UK Style Electrical Modules and Faceplates



EMG13



ETG16  
ESG16



EBG



T70UMB



T70GB

Part Number	Description	Color	Std. Pkg. Qty.	Std. Ctn. Qty.
-------------	-------------	-------	----------------	----------------

### Electrical Modular Outlet

EMG13AW-X	13A full size UK outlet module.	Arctic White	10 pcs.	100 pcs.
-----------	---------------------------------	--------------	---------	----------

### Two-Way Modular Switch

ETG16AW-X	16A two-way full module switch.	Arctic White	10 pcs.	100 pcs.
-----------	---------------------------------	--------------	---------	----------

### Double Pole Modular Switch

ESG16AW-X	16A double pole full module switch.	Arctic White	10 pcs.	100 pcs.
-----------	-------------------------------------	--------------	---------	----------

### Blank Module

EBGAW-X	Full size blank module fits UK T70BU2 faceplate.	Arctic White	10 pcs.	100 pcs.
---------	--------------------------------------------------	--------------	---------	----------

### Snap-On Electrical Faceplate (for T-70/Twin-70/TE-70 Raceway)

T70UMBAW-X	Two gang faceplate accepts two full size modules. Snaps onto T-70, Twin-70 or TE-70 raceway channel. For use with EMG13, ETG16, ESG16 and EBG modules.	Arctic White	10 pcs.	100 pcs.
------------	--------------------------------------------------------------------------------------------------------------------------------------------------------	--------------	---------	----------

### Hanging Box (for T-70/Twin-70/TE-70 Raceway)

T70GB-X	Box snaps into raceway channel to contain wiring in multi-channel applications.	Gray	10 pcs.	100 pcs.
---------	---------------------------------------------------------------------------------	------	---------	----------

◆ All parts listed in Arctic White (AW) color. To order other colors substitute IW (Off White) or IG (Light Gray). Contact factory for details.

#### ORDERING INFORMATION:

Order number of pieces required, in multiples of Standard Package.

# NOTES

---

## PAN-WAY™ T-70 & Twin-70 Non-Metallic Surface Raceways for Power and Communications Cabling (including Fiber Optic Cables)

**PAN-WAY** T-70 and Twin-70 plastic surface raceways are aesthetically designed multichannel systems. These systems can be used to route, conceal and protect power and data cables inside one raceway.

Fittings and terminations are designed to maintain the TIA/EIA required 1" minimum bend radius of high

performance copper and Fiber-Optic cabling throughout the entire system. The two systems are tamper resistant yet allow the qualified installer access for moves, adds and changes.

### T-70 Surface Raceway



pg. B7

- Compact design with capacity for routing power and/or communication cables to workstations
- Inline or Offset termination configurations available
- NEMA Standard Devices and 70mm Faceplates can be flush mounted within the channel

### Twin-70 Surface Raceway



pg. B15

- Two totally separate channels within one raceway with maximum capacity for trunking and routing power and communication cables to workstations
- NEMA Standard Devices and 70mm Faceplates can be flush mounted within the channel
- Independent access to power and communications cabling for added user safety
- No boxes are required for mounting devices

### Panduit **PAN-WAY** T-70 & Twin-70 Raceways provide the following common benefits:

- Attractive and complementary profiles for seamless transitions between systems
- Power Rated to 600V (UL) **meets new UL5A standards**, 300V (CSA) meets CSA 22.2 No. 62-93 standards
- Both raceways are part of the **FIBER-SPEC™** System and are optimized for Fiber-Optic cabling
- Fittings maintain the minimum 1" bend radius required under TIA/EIA 568-A and 569-A for high performance copper and Fiber Optic cabling systems
- Covers and fittings are extremely tamper resistant
- New! Snap-On Faceplates require less hardware for quick terminations and lower installed cost
- Both systems use common components for installer convenience
- Four standard colors available to complement any surrounding decor

**Table of Contents**



<b>PAN-WAY™ T-70</b>	Page
① ② ③ ④ Configurations . . . . .	B4-B5
Raceway Base & Cover . . . . .	B7
Fill Capacities . . . . .	B9-B11



<b>PAN-WAY T-70</b>	
Fittings . . . . .	B7-B8



<b>PAN-WAY T-70</b>	
<b>WORKSTATION OUTLET</b>	
<b>CENTER™</b> Offset Box . . . . .	B8



<b>PAN-WAY Twin-70</b>	
① ② ③ ④ Configurations . . . . .	B12-B13
Raceway Base & Cover . . . . .	B15
Fill Capacities . . . . .	B17-B19



<b>PAN-WAY Twin-70</b>	
Fittings . . . . .	B16



<b>PAN-WAY T-70 &amp; Twin-70</b>	
Accessories . . . . .	B20
T-70 Snap-On Fiber Spool Bracket . . . . .	B20



## PAN-WAY™ T-70 Raceway System

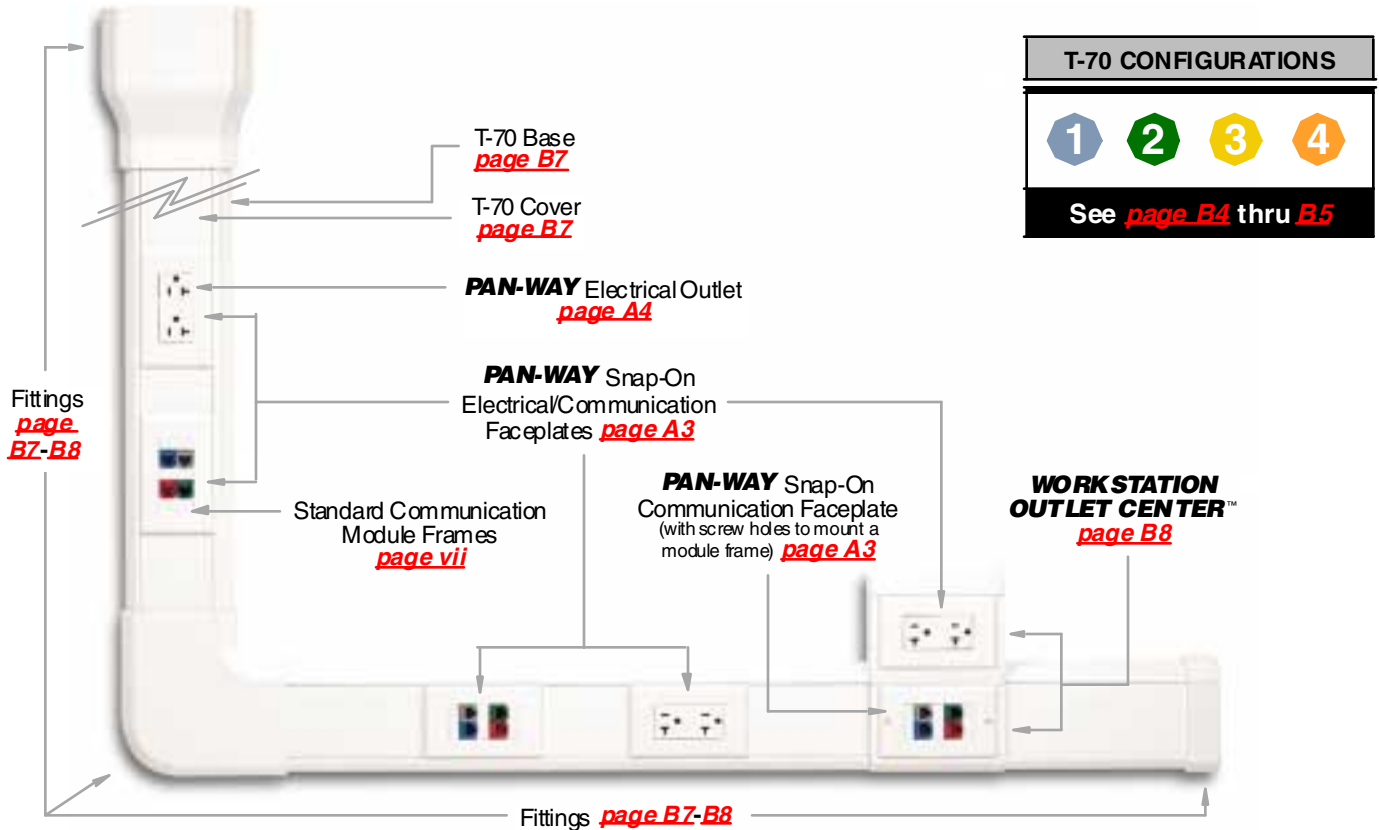

## PAN-WAY Twin-70 Raceway System

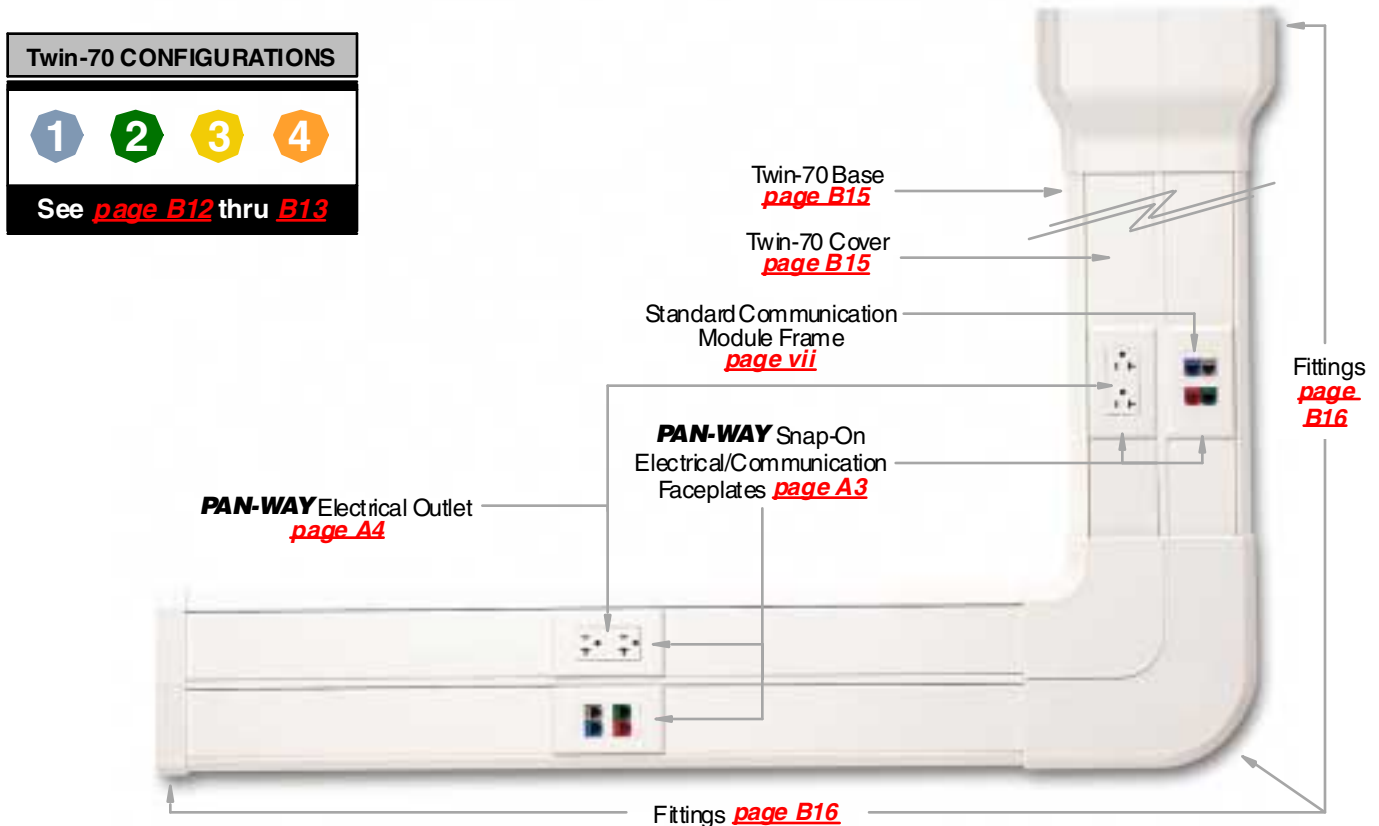

# PAN-WAY™ T-70 Raceway Configurations

**Application:** Routing low voltage cables and/or power cabling: Fiber Optic, Category 5, UTP, ScTP, Coax or any other low voltage cable; power cables (up to 600V).

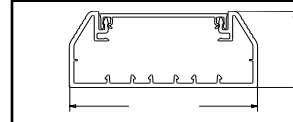

Base: [pg. B7](#)  
 Cover: [pg. B7](#)  
 Fittings: [pg. B7-B8](#)

T-70 RACEWAY CONFIGURATIONS

## 1 PAN-WAY Snap-On Electrical/Communication Faceplates

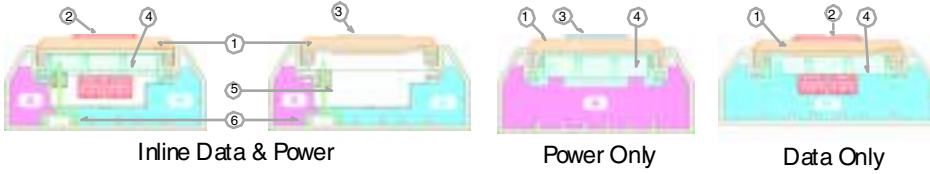

- Snap-On Faceplates provide a superior appearance
- Can use most manufacturers' communication module frames (see chart on [page vii](#))

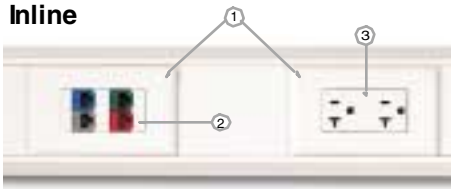

Areas (in <sup>2</sup> )	A	B
Inline Data & Power	.84	1.75
Data Only	—	3.37
Power Only	3.76	—

Components Required	Data Only	Power Only	Data & Power	See Page
1. Snap-On Electrical/Comm. Faceplate(s) (T70PG shown)	X	X	X	<a href="#">A3</a>
2. Standard Communication Module Frame	X		X	<a href="#">vi</a>
3. <b>PAN-WAY</b> Electrical Outlet (ERU20 shown)		X	X	<a href="#">A4</a>
4. Device Mounting Bracket (T70DB-X shown)	X	X	X	<a href="#">B20</a>
5. Hanging Box (T70HB3-X shown)			X	<a href="#">B20</a>
6. Divider Wall (T70DW shown)			X	<a href="#">B7</a>

## 2 PAN-WAY Snap-On Communication Faceplates (with screw holes to mount a module frame)

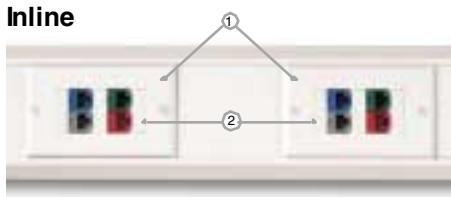

Areas (in <sup>2</sup> )	A	B
Data Only	—	3.89

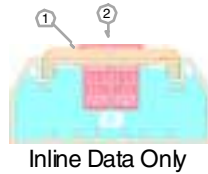

- Faceplate requires no device mounting bracket or hanging box
- Can use most manufacturers' communication module frames (see chart on [page vii](#))

Components Required	Data Only	See Page
1. Snap-On Communication Faceplate (with screw holes to mount a module frame) (T70PGS shown)	X	<a href="#">A3</a>
2. Standard Communications Module Frame	X	<a href="#">vi</a>

Note: For power and data applications use with configuration #1 above or with configuration #3 shown on next page

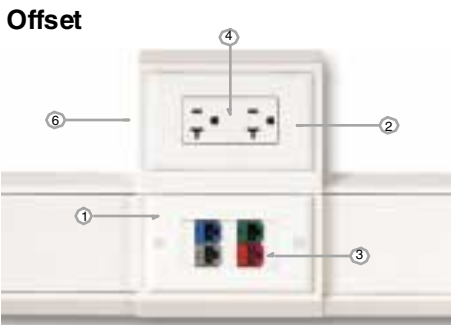

Areas (in <sup>2</sup> )	A	B
Offset Data & Power	1.10	3.04



- Offset configuration adds data capacity
- Can use most manufacturers' communication module frames (see chart on [page vii](#))

Components Required	Data & Power	See Page
1. Snap-On Communication Faceplate (with screw holes to mount a module frame) (T70PGS shown)	X	<a href="#">A3</a>
2. Snap-On Electrical/Communication Faceplate (T70PG shown)	X	<a href="#">A3</a>
3. Standard Communication Module Frame	X	<a href="#">vi</a>
4. <b>PAN-WAY</b> Electrical Outlet (ERU20 shown)	X	<a href="#">A4</a>
5. Divider Wall (T70DW shown)	X	<a href="#">B7</a>
6. <b>WORKSTATION OUTLET CENTER™</b> Offset Box (T70WC2)	X	<a href="#">B8</a>

Note: Snap-On Faceplate Offset configuration shown requires Snap-On Electrical/Communication Faceplate from Configuration #1 for power as noted in offset configuration (component #2)

## PAN-WAY™ T-70 Raceway Configurations

**Application:** Routing low voltage cables and/or power cabling: Fiber Optic, Category 5, UTP, ScTP, Coax or any other low voltage cable; power cables (up to 600V).

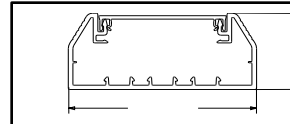

Base: [pg. B7](#)  
 Cover: [pg. B7](#)  
 Fittings: [pg. B7-B8](#)

### 3 PAN-WAY U.S. Standard Screw-On Electrical/Communication Faceplates

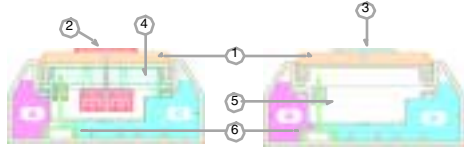

Inline Data & Power

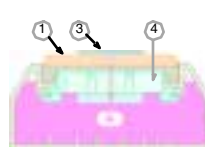

Power Only



Data Only

- U.S. Standard Screw-On Electrical Faceplate is used
- Can use most manufacturers' communication module frames (see chart on [page vii](#))

#### Inline

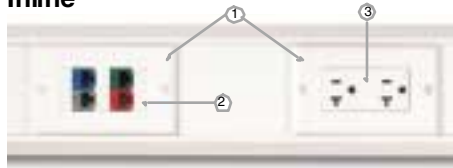

Areas (in <sup>2</sup> )	A	B
Inline Data & Power	.84	1.75
Data Only	—	3.37
Power Only	3.76	—

Components Required	Data Only	Power Only	Data & Power	See Page
1. U.S. Standard Screw-On Electrical/Comm. Faceplate(s) (CPG shown)	X	X	X	<a href="#">A3</a>
2. Standard Communication Module Frame	X	X	X	<a href="#">vii</a>
3. <b>PAN-WAY</b> Electrical Outlet (ERU20 shown)		X	X	<a href="#">A4</a>
4. Device Mounting Bracket (T70DB-X shown)	X	X	X	<a href="#">B20</a>
5. Hanging Box (T70HB3-X shown)			X	<a href="#">B20</a>
6. Divider Wall (T70DW shown)			X	<a href="#">B7</a>

#### Offset

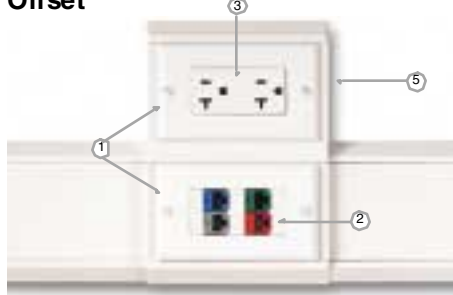

Areas (in <sup>2</sup> )	A	B
Offset Data & Power	1.10	3.04

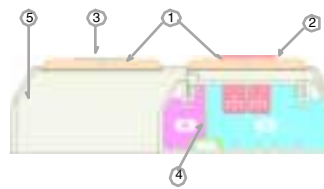

Offset Data & Power

- Offset configuration adds data capacity
- Can use most manufacturers' communication module frames (see chart on [page vii](#))

Components Required	Data & Power	See Page
1. U.S. Standard Screw-On Electrical/Comm. Faceplate(s) (CPG shown)	X	<a href="#">A3</a>
2. Standard Communication Module Frame	X	<a href="#">vii</a>
3. <b>PAN-WAY</b> Electrical Outlet (ERU20 shown)	X	<a href="#">A4</a>
4. Divider Wall (T70DW shown)	X	<a href="#">B7</a>
5. <b>WORKSTATION OUTLET CENTER™</b> Offset Box (T70WC shown)	X	<a href="#">B8</a>

### 4 U.S. Standard Screw-On Communication Faceplates

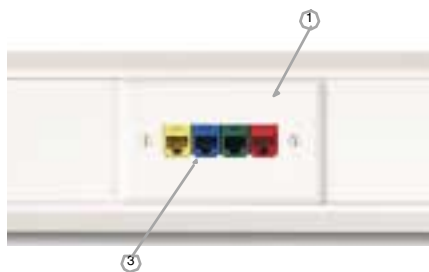

Areas (in <sup>2</sup> )	A	B
Data Only	—	3.74

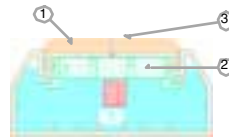

Data Only

- Uses most manufacturers' NEMA standard 70mm communication faceplates
- Panduit® Styles available, for more information refer to [page xij](#)

Components Required	Data Only	See Page
1. U.S. Standard Screw-On Communication Faceplates	X	—
2. Device Mounting Bracket (T70DB-X shown)	X	<a href="#">B20</a>
3. Manufacturers' inserts and/or communication modules	X	—

Note: For power and data applications use with configuration #3 above or with configuration #1 shown on previous page

## PAN-WAY™ T-70 Surface Raceway System Features



**★ NEW!** The **WORKSTATION OUTLET CENTER™**  
 Maximize the cabling capacity of **PAN-WAY** T-70 Raceway by using the new optional **WORKSTATION OUTLET CENTER** offset box. Two versions are available for **PAN-WAY** Snap-On Electrical/Communication Faceplates or U.S. Standard Screw-On Electrical/Communication Faceplates.

See Configuration 1 or 3 [pg. B4-B5](#)



T-70 has adequate capacity for trunking applications



### Flush Mounted Applications

U.S. Standard Screw-On Electrical/Communication Faceplates and **PAN-WAY** Snap-On Electrical/Communication Faceplates can be flush mounted into the T-70 channel to place power & data devices wherever needed.

See Configuration 1 or 3 [pg. B4-B5](#)

### Solution #2 — Example Installation



Using the **PAN-WAY** Snap-On Communication Faceplate (with screw holes to mount a module frame)

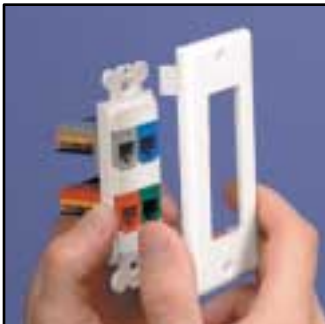

Place module frame behind faceplate...



Screw module frame and faceplate together...



Snap faceplate to channel...



Done!

For Technical Assistance, call: 888-506-5400, Ext. 8287 (outside the U.S., see inside back cover for International Directory)

## PAN-WAY™ T-70 Surface Raceway Base & Cover

**PAN-WAY** Type T-70 Surface Raceway is an aesthetically designed, multi-channel system to route, protect and conceal data, voice, video, fiber-optic and power cabling.

### T-70 System Benefits:

- Power rated to 600V(UL), 300V(CSA) **meets new UL5A standard** and CSA 22.2 No. 62-93 standards
- Fittings maintain the TIA/EIA required 1" bend radius for Fiber-Optic and Category 5 cabling systems
- Supplied with pre-punched mounting holes
- Extremely tamper resistant



Compatible with:  
 — **PAN-WAY** Snap-On Faceplates  
 — Any U.S. Standard Screw-On Electrical/Communication Faceplate(s)



T70B

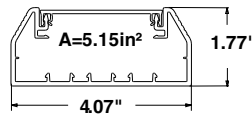

T70C



T70DW

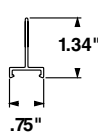

Part Number	Std. Ctn. Qty.	Part Number	Std. Ctn. Qty.	Colors♦
-------------	----------------	-------------	----------------	---------

#### T-70 Raceway Base

8 ft. lengths		10 ft. lengths		
T70BIW8	48 ft.	T70BIW10	60 ft.	Off White

T-70 raceway base in 8 or 10 ft. lengths. Supplied with pre-punched mounting holes every 8".

#### T-70 Raceway Cover

T70CIW8	96 ft.	T70CIW10	120 ft.	Off White
---------	--------	----------	---------	-----------

T-70 raceway cover in 8 or 10 ft. lengths.

#### T-70 Raceway Divider Wall

T70DW8	96 ft.	T70DW10	120 ft.	Gray ONLY
--------	--------	---------	---------	-----------

Snaps onto rails in raceway base to create separate channels. Must use with wire retainers to ensure channel separation per UL/CSA.

**NOTE:** Order raceway base and cover separately.

♦ All parts listed in Off White (IW) color. To order other colors substitute EI (Electric Ivory), IG (Light Gray), and WH (White). Contact factory for details.

#### ORDERING INFORMATION:

Order number of feet required, in multiples of Standard Length Increment.



### Type T-70 Fittings



T70BC\*\*-X



T70CC\*\*-X



T70IC



T70OC



T70RA



T70EC



Part Number	Description	Colors♦	Std. Pkg. Qty.	Std. Ctn. Qty.
T70BCIW-X	Base Coupler Fitting	Off White	10 pcs.	100 pcs.
T70CCIW-X	Cover Coupler Fitting	Off White	10 pcs.	100 pcs.
T70ICIW	Inside Corner Fitting	Off White	1 pcs.	10 pcs.
T70OCIW	Outside Corner Fitting	Off White	1 pc.	10 pcs.
T70RAIW	Right Angle Fitting	Off White	1 pc.	10 pcs.
T70ECIW	End Cap Fitting Conduit breakouts: 1/2"	Off White	1 pc.	10 pcs.

♦ All parts listed in Off White (IW) color. To order other colors substitute EI (Electric Ivory), IG (Light Gray), and WH (White). Contact factory for details.

#### ORDERING INFORMATION:

Order number of pieces required, in multiples of Standard Package.

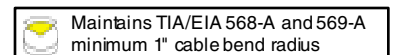

**UL** **SA LISTED** **SE** Type T-70 Fittings (cont'd)



Part Number	Description	Std. Pkg. Qty.	Colors ♦	Std. Ctn. Qty.
T70TIW	Tee Fitting	1 pc.	Off White	10 pcs.
T70TDT (Top Position) T70TDC (Center Position) T70TDB (Bottom Position)	T-70 Raceway Divider Inserts (Power & Data Applications). Separate power and data within Tee Fitting when divider wall placed in top, center or bottom position	1 pc.	Gray ONLY	10 pcs.
T70EEIW	Entrance End Fitting Conduit breakouts: 1/2", 3/4", 1", 1 1/4" Entry from ceiling or wall.	1 pc.	Off White	10 pcs.
T70TRIW	Transition Fitting to any LD Profile Raceway. Includes fitting for bend radius control. Maintains channel separation within T-70 raceway — Base & Cover	1 pc.	Off White	10 pcs.
T70TRCIW	Transition Fitting to any LD Profile Raceway — Cover Only	1 pc.	Off White	10 pcs.
T70TRI	Divided insert for T70 to LD2P10. Maintains channel separation within T70TR Fitting	1 pc.	Gray ONLY	10 pcs.

♦ All parts listed in Off White (IW) color. To order other colors substitute EI (Electric Ivory), IG (Light Gray), and WH (White). Contact factory for details.  
T-70 Raceway Accessories available on [page B20](#)

Maintains TIA/EIA 568-A and 569-A minimum 1" cable bend radius

**Tee Insert Configurations**

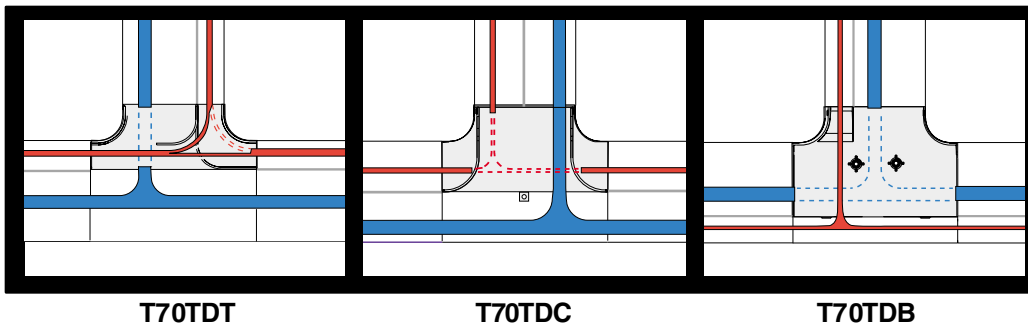

**— KEY —**

- █ Data Cabling
- █ Power Cabling
- Tee Insert
- Divider Wall

Divided Tee Inserts are used to separate power and data cabling for various tee configurations. Maintains 1" bend radius of data cables.

**UL** **SA LISTED** **SE** **PAN-WAY WORKSTATION OUTLET CENTER™** Offset Box for T-70 Raceway



Part Number	Description	Colors ♦	Std. Pkg. Qty.	Std. Ctn. Qty.
<b>WORKSTATION OUTLET CENTER</b> Offset Box — For U.S. Standard Screw-On Electrical/Communication Faceplates				
T70WC1W	Two-piece box & bracket accept any NEMA standard 70mm faceplate with mounting hole widths of 3.28" (83.5mm).	Off White	1 pc.	10 pcs.
<b>WORKSTATION OUTLET CENTER</b> Offset Box — For PAN-WAY Snap-On Electrical/Communication Faceplates				
T70WC2IW	Two-piece box & bracket accept any standard electrical outlet. Accepts any <b>PAN-WAY</b> Snap-On Electrical/Communication Faceplates.	Off White	1 pc.	10 pcs.

♦ All parts listed in Off White (IW) color. To order other colors substitute EI (Electric Ivory), IG (Light Gray), and WH (White). Contact factory for details.

The **WORKSTATION OUTLET CENTER** offset box places electrical and communications devices into a common area while maximizing the cabling capacity of the raceway channel.



The **WORKSTATION OUTLET CENTER** offset box Snap-On Faceplate version provides the lowest installed cost by reducing hardware and labor.



For Technical Assistance, call: 888-506-5400, Ext. 8287 (outside the U.S., see inside back cover for International Directory)

## Fill Capacities for T-70 Raceway

Use the wirefill configurations below along with the wirefill information contained on the next two pages as a guide in selecting the proper size raceway. The maximum amounts may vary according to the wire installation methods, straightness of wires, etc.

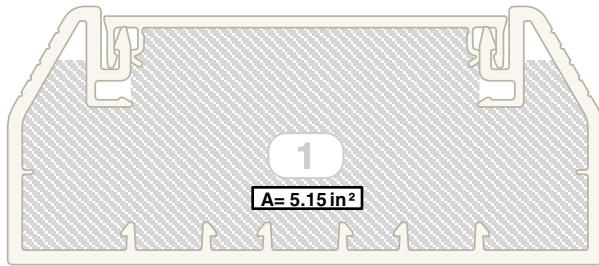

**Wirefill #1:** T-70 Raceway with no devices

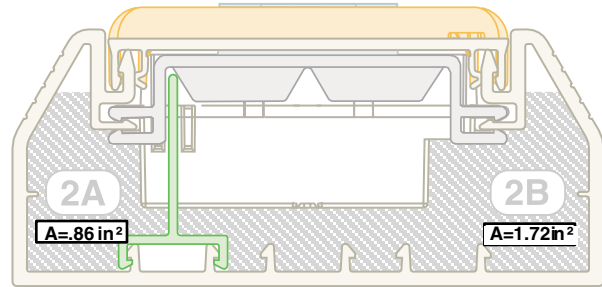

**Wirefill #2:** Power & Data using Three Sided Hanging Box and Device Bracket

*Includes: Three sided Hanging Box, Divider Wall, Wire Retainer, Snap-On Electrical/Communication Faceplate. Not shown for clarity: U.S. Standard Electrical Outlet, Standard Communication Module Frame and Communication Modules.*

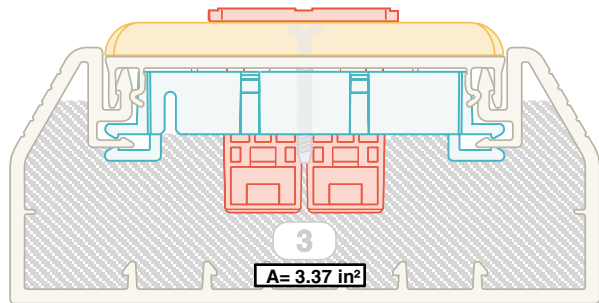

**Wirefill #3:** Data Only using U.S. Standard Screw-On Electrical/Communication Faceplates

*Includes: Device Bracket, U.S. Standard Screw-On Electrical/Communication Faceplate, Standard Communication Module Frame and Communication Modules.*

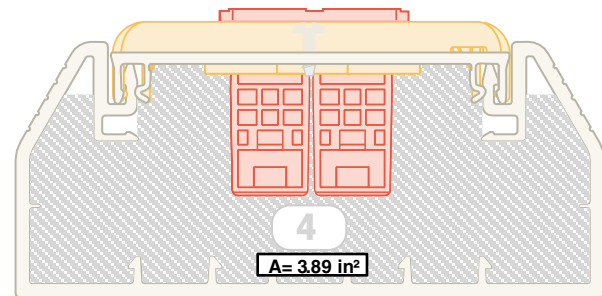

**Wirefill #4:** Data Only using Snap-On Communication Faceplates (with screw holes to mount a module frame)

*Includes: Snap-On Communication Faceplate (with screw holes to mount a module frame), Standard Communication Module Frame and Communication Modules*

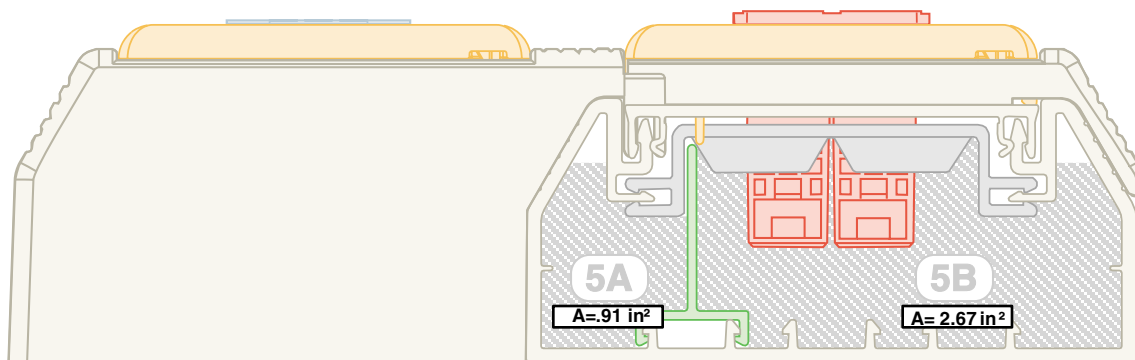

**Wirefill #5:** Power & Data using the **WORKSTATION OUTLET CENTER™** Offset Box

*Includes: WORKSTATION OUTLET CENTER Offset Box, Divider Wall, Wire Retainer, Snap-On Electrical/Communication Faceplate (with screw holes to mount a module frame), Standard Communication Module Frame and Communication Modules.*

## Fill Capacities for T-70 Raceway

This information is to be used as a guide in selecting the proper size raceway. The maximum amounts may vary according to the wire installation methods, straightness of wires, etc. Reference wirefill configurations on [page B9](#).

**SPEC=40% wirefill**—the recommended design in cable capacity.  
Leaves room for future moves, adds and changes

**MAX=60% wirefill**—based on useful internal area and cable areas

### Fill Capacity Table for: ·Electrical ·Voice Grade 24 AWG UTP ·Data Grade 24 AWG UTP

Raceway Channel Wirefill Configurations	See Fill #	Electrical Cables			Voice Grade Cables						Data Grade Cables			
		AWG			24 AWG UTP CM/CMR						24 AWG UTP CM			
		14	12	10	2 pr		3 pr		4 pr		25 pr		Cat. 5 4 pr	
		THHN/T90			DIA.= 0.120		DIA.= 0.150		DIA.= 0.190		DIA.=0.422		DIA.=0.217	
		0.105	0.122	0.153	FILL		FILL		FILL		FILL		FILL	
MAX	MAX	MAX	SPEC	MAX	SPEC	MAX	SPEC	MAX	SPEC	MAX	SPEC	MAX	SPEC	MAX
<b>Wirefill #1: T70 with No Devices</b>	1	24	20	5	182	273	117	175	73	109	15	22	56	84
<b>Wirefill #2: Power &amp; Data using Three Sided Hanging Box &amp; Device Bracket</b>	2A	14	11	7	30	46	19	29	12	18	2	4	9	14
	2B	**	**	**	61	91	39	58	24	36	5	7	19	28
<b>Wirefill #3: Data Only using U.S. Standard Screw-On Electrical/Communication Faceplates</b>	3	**	**	**	119	178	76	114	47	71	9	14	36	54
<b>Wirefill #4: Data Only using Snap-On Communication Faceplates (with screw holes to mount module frames)</b>	4	**	**	**	137	206	87	131	54	82	11	16	42	63
<b>Wirefill #5: Power &amp; Data using the WORKSTATION OUTLET CENTER™ Offset Box</b>	5A	14	11	7	32	48	20	31	12	19	2	3	9	14
	5B	**	**	**	94	141	60	90	37	56	7	11	28	43

NOTE: See [page xiv-xv](#) for further explanation of wirefill data.  
\*\* Not power configuration

### Fill Capacity Table for: ·Data Grade 22 AWG UTP ·Data Grade 24, 22 AWG STP ·1A STP

Raceway Channel Wirefill Configurations	See Fill #	Data Grade Cables															
		24 AWG STP CM				22 AWG UTP CM				22 AWG STP CM				1A 22 AWG STP CM			
		25 pr		4 pr		25 pr		4 pr		25 pr		4 pr		25 pr		4 pr	
		DIA.=0.512		DIA.=0.250		DIA.= 0.544		DIA.= 0.234		DIA.=0.635		DIA.=0.286		DIA.=0.430			
		FILL		FILL		FILL		FILL		FILL		FILL		FILL			
SPEC	MAX	SPEC	MAX	SPEC	MAX	SPEC	MAX	SPEC	MAX	SPEC	MAX	SPEC	MAX	SPEC	MAX		
<b>Wirefill #1: T70 with No Devices</b>	1	10	15	42	63	9	13	48	72	7	10	32	48	14	21		
<b>Wirefill #2: Power &amp; Data using Three Sided Hanging Box &amp; Device Bracket</b>	2A	2	3	7	11	1	2	8	12	1	2	5	8	2	4		
	2B	3	5	14	21	3	4	16	24	2	3	11	11	5	7		
<b>Wirefill #3: Data Only using U.S. Standard Screw-On Electrical/Communication Faceplates</b>	3	6	9	27	41	5	8	31	46	4	6	20	31	9	13		
<b>Wirefill #4: Data Only using Snap-On Communication Faceplates (with screw holes to mount module frames)</b>	4	7	11	31	47	6	10	36	54	4	7	24	36	10	16		
<b>Wirefill #5: Power &amp; Data using the WORKSTATION OUTLET CENTER™ Offset Box</b>	5A	1	2	7	11	1	2	8	12	1	1	5	8	2	3		
	5B	5	7	21	32	4	6	24	37	3	5	16	24	7	11		

NOTE: See [page xiv-xv](#) for further explanation of wirefill data.



## Fill Capacities for T-70 Raceway

This information is to be used as a guide in selecting the proper size raceway. The maximum amounts may vary according to the wire installation methods, straightness of wires, etc. Reference wirefill configurations on [page B9](#).

**SPEC=40% wirefill**—the recommended design in cable capacity.  
Leaves room for future moves, adds and changes

**MAX=60% wirefill**—based on useful internal area and cable areas

### Fill Capacity Table for: •Coax Cables

Raceway Channel Wirefill Configurations	See Fill #	Coax Cables									
		RG6/u		RG11/u		RG58/u		RG59/u		RG62A/u	
		DIA.=0.270		DIA.=0.405		DIA.=0.193		DIA.=0.242		DIA.=0.242	
		FILL		FILL		FILL		FILL		FILL	
		SPEC	MAX	SPEC	MAX	SPEC	MAX	SPEC	MAX	SPEC	MAX
<b>Wirefill #1:</b> T70 with No Devices	1	36	54	16	24	70	106	45	67	45	67
<b>Wirefill #2:</b> Power & Data using Three Sided Hanging Box & Device Bracket	2A	6	9	3	4	12	18	7	11	7	11
	2B	12	18	5	8	24	35	15	22	15	22
<b>Wirefill #3:</b> Data Only using U.S. Standard Screw-On Electrical/Communication Faceplates	3	23	35	10	15	46	69	29	43	29	43
<b>Wirefill #4:</b> Data Only using Snap-On Communication Faceplates (with screw holes to mount module frames)	4	27	40	12	18	53	79	33	50	33	50
<b>Wirefill #5:</b> Power & Data using the <b>WORKSTATION OUTLET CENTER™</b> Offset Box	5A	6	9	2	4	12	18	7	11	7	11
	5B	18	28	8	12	36	54	23	34	23	34

NOTE: See [page xiv-xv](#) for further explanation of wirefill data.

### Fill Capacity Table for: •Fiber Optic Cable (62.5/125mm) •Signal Cables

Raceway Channel Wirefill Configurations	See Fill #	Fiber Optic Cables (62.5/125mm)						Signal Cables							
		2 Strand		4 Strand		6 Strand		18AWG		20AWG		22AWG		24AWG	
		DIA.=0.175		DIA.=0.175		DIA.=0.210		DIA.=0.066		DIA.=0.057		DIA.=0.050		DIA.=0.044	
		FILL		FILL		FILL		FILL		FILL		FILL		FILL	
		SPEC	MAX	SPEC	MAX	SPEC	MAX	SPEC	MAX	SPEC	MAX	SPEC	MAX	SPEC	MAX
<b>Wirefill #1:</b> T70 with No Devices	1	86	129	86	129	60	89	602	904	602	904	1050	1575	1355	2033
<b>Wirefill #2:</b> Power & Data using Three Sided Hanging Box & Device Bracket	2A	14	21	14	21	10	15	140	210	140	210	175	263	226	340
	2B	29	43	29	43	20	30	279	419	279	419	351	526	453	679
<b>Wirefill #3:</b> Data Only using U.S. Standard Screw-On Electrical/Communication Faceplates	3	55	83	55	83	38	58	393	590	527	791	685	1028	885	1328
<b>Wirefill #4:</b> Data Only using Snap-On Communication Faceplates (with screw holes to mount module frames)	4	64	96	64	96	44	67	454	681	609	913	791	1187	1022	1533
<b>Wirefill #5:</b> Power & Data using the <b>WORKSTATION OUTLET CENTER™</b> Offset Box	5A	15	22	15	22	10	15	106	160	143	214	186	279	240	360
	5B	44	66	44	66	30	46	312	468	418	628	544	816	702	1054

NOTE: See [page xiv-xv](#) for further explanation of wirefill data.

### Raceway Cutting Instructions:

For small quantities, use a fine tooth handsaw. For larger quantities use a plastic cutting saw blade for clean, burr-free cuts. Recommend: *Carbide 80T or 100T; .090" thickness, .125" kerf.*

# PAN-WAY™ Twin-70 Raceway Configurations

**Application:** Routing communication cables and/or power cabling: Fiber Optic, Category 5, UTP, ScTP, Coax or any other low voltage cable; power cables (up to 600V).

Base: [pg. B15](#)  
 Cover: [pg. B15](#)  
 Fittings: [pg. B16](#)

Twin-70 RACEWAY CONFIGURATIONS

## 1 PAN-WAY Snap-On Electrical/Communication Faceplates

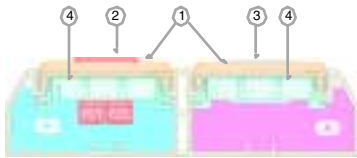

Data & Power

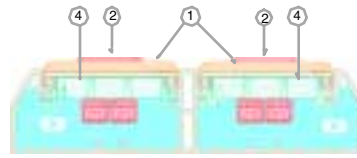

Data Only

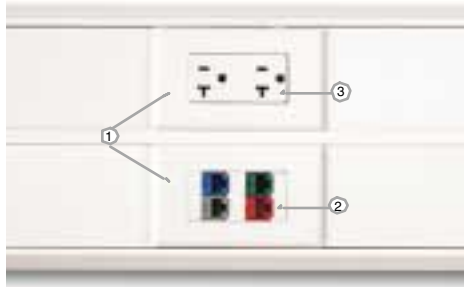

Areas (in <sup>2</sup> )	A	B
Data & Power	3.32	2.80
Data Only	—	2.80(x2)

- Snap-On Faceplates provide a superior appearance (No screws required).
- Can use most manufacturers' communication module frames (see chart on [page vii](#))

Components Required	Data Only	Power Only	Data & Power	See Page
1. Snap-On Electrical/Communication Faceplate(s) (T70PG shown)	X	X	X	<a href="#">A3</a>
2. Standard Communication Module Frame	X		X	<a href="#">vii</a>
3. <b>PAN-WAY</b> Electrical Outlet (ERU20 shown)		X	X	<a href="#">A4</a>
4. Device Mounting Bracket (T70DB-X shown)	X	X	X	<a href="#">B20</a>

## 2 PAN-WAY Snap-On Communication Faceplates (with screw holes to mount a module frame)

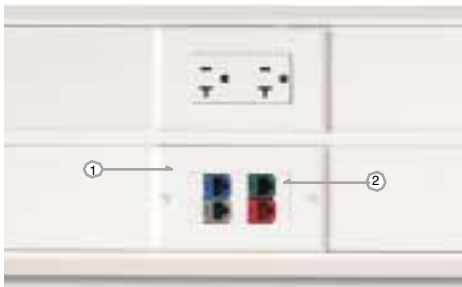

Areas (in <sup>2</sup> )	A	B
Data Only	3.32	3.32

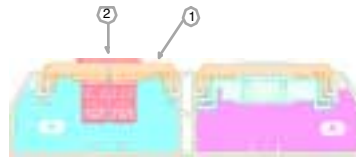

Data & Power

- Faceplate requires no device mounting bracket or hanging box
- Can use most manufacturers' communication module frames (see chart on [page vii](#))

Components Required	Data Only	Power Only	Data & Power	See Page
1. Snap-On Communication Faceplate (with screw holes to mount a module frame) (T70PGS shown)	X			<a href="#">A3</a>
2. Standard Communication Module Frame	X			<a href="#">vii</a>

Note: For power application shown add the power only components from configuration #1

## PAN-WAY™ Twin-70 Raceway Configurations

**Application:** Routing communication cables and/or power cabling: Fiber Optic, Category 5, UTP, ScTP, Coax or any other low voltage cable; power cables (up to 600V).

Base: [pg. B15](#)  
 Cover: [pg. B15](#)  
 Fittings: [pg. B16](#)

### 3 PAN-WAY U.S. Standard Screw-On Electrical/Communication Faceplates



Data & Power

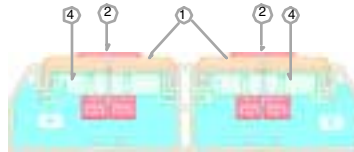

Data Only

- U.S. Standard Screw-On Electrical Faceplate is used
- Can use most manufacturers' communication module frames (see chart on [page vii](#))

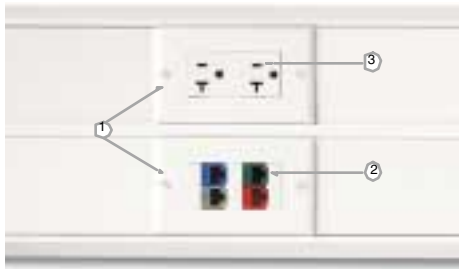

Areas (in <sup>2</sup> )	A	B
Data & Power	3.32	2.80
Data Only	—	2.80 (x2)

Components Required	Data Only	Power Only	Data & Power	See Page
1. U.S. Standard Screw-On Electrical/Comm. Faceplate(s) (CPG shown)	X	X	X	<a href="#">A3</a>
2. Standard Communication Module Frame	X		X	<a href="#">vii</a>
3. <b>PAN-WAY</b> Electrical Outlet (ERU20 shown)		X	X	<a href="#">A4</a>
4. Device Mounting Bracket (T70DB-X shown)	X	X	X	<a href="#">B20</a>

### 4 U.S. Standard Screw-On Communication Faceplates

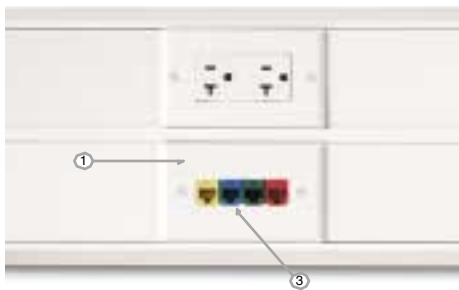

Areas (in <sup>2</sup> )	A	B
Data Only	3.32	3.17



Data & Power

- Uses most manufacturers' NEMA standard 70mm communication faceplates (see chart on [page vii](#))
- Panduit® Styles available, for more information refer to [page xii](#)

Components Required	Data Only	See Page
1. U.S. Standard Screw-On Communication Faceplates	X	<a href="#">A3</a>
2. Device Mounting Bracket (T70DB-X shown)	X	<a href="#">B20</a>
3. Manufacturers' inserts and/or modules	X	—

Note: For power application shown add the power only components from configuration #3

Twin-70 RACEWAY CONFIGURATIONS

**PAN-WAY™ Twin-70 Surface Raceway System Features**



See Configuration 1 or 3 [pg. B12 - B13](#)

Extreme tamper-resistance with a large capacity makes Twin-70 raceway ideal for routing and maintaining power and data into computing intense environments such as media centers and computer labs.

**NEW!**



[pg. B16](#)

Enter the raceway from a ceiling drop or "thru-wall" with the Entrance End Fitting

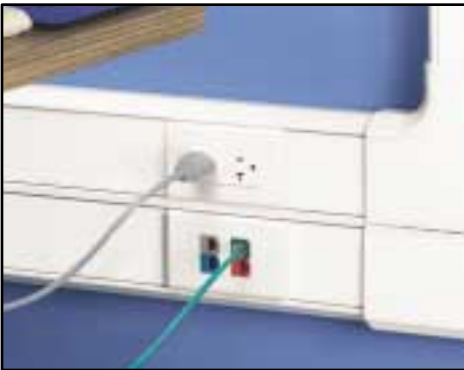

Maximizes safety by maintaining total separation of data and power cabling throughout the entire raceway system.



See Configuration 1 or 3 [pg. B12 - B13](#)

Both U.S. Standard Screw-On Faceplates and **PAN-WAY** Snap-On Electrical/Communication Faceplates are flush mounted into the Twin-70 channel to place power & data devices wherever needed.



**NEW!** [pg. A3](#)  
Terminations are a Snap!

**PAN-WAY** T-70 Surface Raceway is fully compatible with New **PAN-WAY** Twin-70 Surface Raceway to drop power & communications cabling into the work environment.

New **PAN-WAY** Snap-On Electrical/Communication Faceplates place devices anywhere in the raceway, quickly!



Twin-70 has added capacity for trunking applications

## PAN-WAY™ Twin-70 Surface Raceway Base & Cover

**PAN-WAY** Type Twin-70 Surface Raceway is an aesthetically designed system featuring two separate dedicated channels that can form up to four total channels to route, protect and conceal data, voice, video, fiber-optic and power cabling.

### Twin-70 System Benefits:

- Power rated to 600V(UL), 300V(CSA) meets **new UL5A standard** and CSA 22.2 No. 62-93 standards
- Separate channels allow independent access to power and communication cabling throughout the entire system
- Fittings maintain the TIA/EIA required 1" bend radius for Fiber-Optic and Category 5 cabling systems
- Extremely tamper resistant
- Supplied with pre-punched mounting holes



Compatible with:  
 — **PAN-WAY** Snap-On Faceplates  
 — Any U.S. Standard Screw-On Electrical/Communication Faceplate(s)

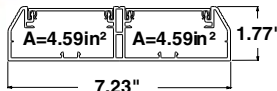

T702B



T70C

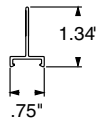

T70DW

Part Number	Std. Ctn. Qty.	Part Number	Std. Ctn. Qty.	Colors♦
-------------	----------------	-------------	----------------	---------

#### Twin-70 Raceway Base

8 ft. lengths		10 ft. lengths		
T702BIW8	24 ft.	T702BIW10	30 ft.	Off White
Twin-70 raceway base in 8 or 10 ft. lengths. Supplied with pre-punched mounting holes every 8".				

#### T-70 Raceway Cover

T70CIW8	96 ft.	T70CIW10	120 ft.	Off White
T-70 or Twin-70 raceway tamper resistant cover in 8 or 10 ft. lengths. <b>NOTE: Two feet of cover needed for every foot of base.</b>				

#### T-70 Raceway Divider Wall

T70DW8	96 ft.	T70DW10	120 ft.	Gray ONLY
Snaps onto rails in raceway base to create separate channels. Must use with wire retainers to ensure channel separation per UL/CSA.				

♦ All parts listed in Off White (IW) color. To order other colors substitute EI (Electric Ivory), IG (Light Gray), and WH (White). Contact factory for details.  
**NOTE:** Order raceway base and cover separately.

#### ORDERING INFORMATION:

Order number of feet required, in multiples of Standard Length Increment.



**Type Twin-70 Fittings**



T702BC\*\* -X



T70CC\*\* -X



T702OC



T702IC



T702RA



T702TR



T702TRL



T702TRI



T702T



T702EE



T702EC

Part Number	Description	Colors◆	Std. Pkg. Qty.	Std. Ctn. Qty.
T702BCIW-X	Base Coupler Fitting	Off White	10 pcs.	100 pcs.
T70CCIW-X	Cover Coupler Fitting	Off White	10 pcs.	100 pcs.
T702ICIW	Inside Corner Fitting	Off White	1 pcs.	10 pcs.
T702OCIW	Outside Corner Fitting	Off White	1 pc.	10 pcs.
T702RAIW	Right Angle Fitting	Off White	1 pc.	10 pcs.
T702TRIW	Transition Fitting — To T-70 Raceway	Off White	1 pc.	5 pcs.
T702TRLIW	Transition Fitting — To any LD Profile Raceway	Off White	1 pc.	5 pcs.
T702TRI	Divided Insert for T702 to T70 or T702 to LD profile. Maintains channel separation within T702TR or T702TRL fitting.	Gray ONLY	1 pc.	5 pcs.
T702TIW	Tee Fitting	Off White	1 pc.	5 pcs.
T702EEIW	Entrance End Fitting Conduit breakouts: ½", ¾", 1", 1¼" Entry from ceiling or wall.	Off White	1 pc.	5 pcs.
T702ECIW	End Cap Fitting Conduit breakouts: ½"	Off White	1 pc.	10 pcs.



◆ All parts listed in Off White (IW) color. To order other colors substitute EI (Electric Ivory), IG (Light Gray), and WH (White). Contact factory for details.

**ORDERING INFORMATION:**

Order number of pieces required, in multiples of Standard Package.

Maintains TIA/EIA 568-A and 569-A minimum 1" cable bend radius

## Fill Capacities for Twin-70 Raceway

Use the wirefill configurations below along with the wirefill information contained on the next two pages as a guide in selecting the proper size raceway. The maximum amounts may vary according to the wire installation methods, straightness of wires, etc.

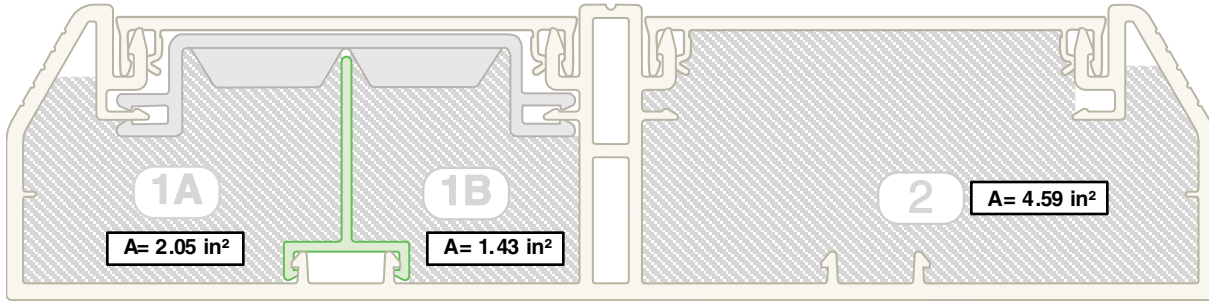

**Wirefill #1: Power & Data with No Terminations**

**Wirefill #2: One Twin-70 Channel with No Devices**

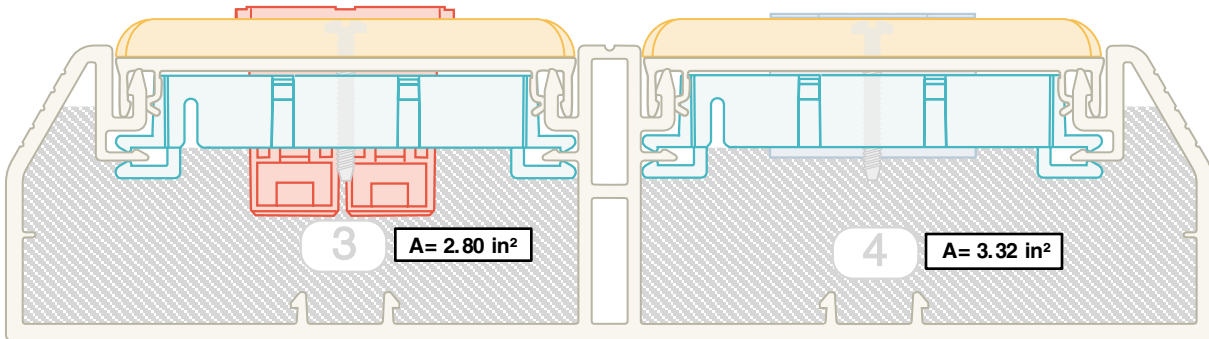

**Wirefill #3: Data Only using Device Bracket & U.S. Standard Screw-On Faceplates**

*Includes: Device Bracket, U.S. Standard Screw-On Electrical/Communication Faceplate, Standard Communication Module Frame and Communication Modules*

**Wirefill #4: Power using Device Bracket & U.S. Standard Screw-On Faceplates**

*Includes: Device Bracket, U.S. Standard Screw-On Electrical/Communication Faceplate and U.S. Standard Electrical Outlet*

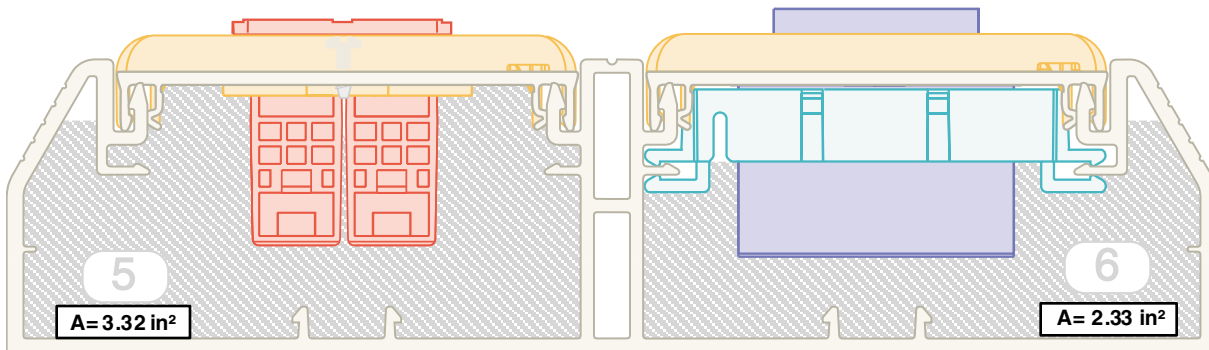

**Wirefill #5: Data Only using Snap-On Electrical/Communication Faceplates (with screw holes to mount a module frame)**

*Includes: Snap-On Communication Faceplate (with screw holes to mount a module frame), Standard Communication Module Frame and Communication Modules*

**Wirefill #6: 20A TVSS Rectangular Outlet using Device Bracket & Snap-On Electrical/Communication Faceplate**

*Includes: Device Bracket, Snap-On Electrical/Communication Faceplate and 20A TVSS Rectangular Outlet*

## Fill Capacities for Twin-70 Raceway

This information is to be used as a guide in selecting the proper size raceway. The maximum amounts may vary according to the wire installation methods, straightness of wires, etc. Reference wirefill configurations on [page B17](#).

**SPEC=40% wirefill**—the recommended design in cable capacity.  
Leaves room for future moves, adds and changes

**MAX=60% wirefill**—based on useful internal area and cable areas

### Fill Capacity Table for: ·Electrical ·Voice Grade 24 AWG UTP ·Data Grade 24 AWG UTP

Raceway Channel Wirefill Configurations	See Fill #	Electrical Cables			Voice Grade Cables						Data Grade Cables			
		AWG			24 AWG UTP CM/CMR						24 AWG UTP CM			
		14	12	10	2 pr		3 pr		4 pr		25 pr		Cat. 5 4 pr	
		THHN/T90			DIA.= 0.120		DIA.= 0.150		DIA.= 0.190		DIA.=0.422		DIA.=0.217	
		0.105	0.122	0.153	FILL		FILL		FILL		FILL		FILL	
	MAX	MAX	MAX	SPEC	MAX	SPEC	MAX	SPEC	MAX	SPEC	MAX	SPEC	MAX	
Wirefill #1: Power & Data with No Terminations	1A	n/a	n/a	n/a	73	109	46	70	29	43	6	9	22	33
	1B	16	16	15	51	76	32	49	20	30	4	6	15	23
Wirefill #2: One Twin-70 Channel with No Devices	2	n/a	n/a	n/a	162	244	104	156	65	97	13	20	50	75
Wirefill #3: Data Only using Device Bracket & U.S. Standard Screw-On Faceplates	3	**	**	**	99	148	63	95	39	59	8	12	30	45
Wirefill #4: Power using Device Bracket & U.S. Standard Screw-On Faceplates	4	15	13	13	117	176	75	113	47	70	9	14	36	54
Wirefill #5: Data Only using Snap-On Electrical/Communication Faceplates (with screw holes to mount a module frame)	5	**	**	**	117	176	75	113	47	70	9	14	36	54
Wirefill #6: 20A TVSS Rectangular Outlet using Device Bracket & Snap-On Electrical/Communication faceplate Faceplate	6	16	16	14	82	124	53	79	33	49	7	10	25	38

NOTE: See [page xiv-xv](#) for further explanation of wirefill data.  
\*\* Not power configuration

### Fill Capacity Table for: ·Data Grade 22 AWG UTP ·Data Grade 24, 22 AWG STP ·1A STP

Raceway Channel Wirefill Configurations	See Fill #	Data Grade Cables												1A 22 AWG STP CM	
		24 AWG STP CM				22 AWG UTP CM				22 AWG STP CM					
		25 pr		4 pr		25 pr		4 pr		25 pr		4 pr			
		DIA.=0.512		DIA.=0.250		DIA.= 0.544		DIA.= 0.234		DIA.=0.635		DIA.=0.286			
		FILL		FILL		FILL		FILL		FILL		FILL		FILL	
		SPEC	MAX	SPEC	MAX	SPEC	MAX	SPEC	MAX	SPEC	MAX	SPEC	MAX	SPEC	MAX
Wirefill #1: Power & Data No Terminations	1A	4	6	17	25	4	5	19	29	3	4	13	19	6	8
	1B	3	4	12	17	2	4	13	20	2	3	9	13	4	6
Wirefill #2: One Twin-70 Channel with No Devices	2	9	13	37	56	8	12	43	64	6	9	29	43	13	19
Wirefill #3: Data Only using Device Bracket & U.S. Standard Screw-On Faceplates	3	5	8	22	34	4	7	26	39	3	5	17	26	7	11
Wirefill #4: Power using Device Bracket & U.S. Standard Screw-On Faceplates	4	6	10	27	41	6	9	31	46	4	6	21	31	9	14
Wirefill #5: Data Only using Snap-On Electrical/Communication Faceplates (with screw holes to mount a module frame)	5	6	10	27	41	6	9	31	46	4	6	21	31	9	14
Wirefill #6: 20A TVSS Rectangular Outlet using Device Bracket & Snap-On Electrical/Communication faceplate Faceplate	6	5	7	19	28	4	6	22	33	3	4	15	22	6	10

NOTE: See [page xiv-xv](#) for further explanation of wirefill data.

For Technical Assistance, call: 888-506-5400, Ext. 8287 (outside the U.S., see inside back cover for International Directory)



## Fill Capacities for Twin-70 Raceway

This information is to be used as a guide in selecting the proper size raceway. The maximum amounts may vary according to the wire installation methods, straightness of wires, etc. Reference wirefill configurations on [page B1Z](#).

**SPEC=40% wirefill**—the recommended design in cable capacity.  
Leaves room for future moves, adds and changes

**MAX=60% wirefill**—based on useful internal area and cable areas

### Fill Capacity Table for: •Coax Cables

Raceway Channel Wirefill Configurations	See Fill #	Coax Cables									
		RG6/u		RG11/u		RG58/u		RG59/u		RG 62A/u	
		DIA.=0.270		DIA.=0.405		DIA.=0.193		DIA.=0.242		DIA.=0.242	
		FILL		FILL		FILL		FILL		FILL	
		SPEC	MAX	SPEC	MAX	SPEC	MAX	SPEC	MAX	SPEC	MAX
<b>Wirefill #1: Power &amp; Data No Terminations</b>	<b>1A</b>	14	21	6	10	28	42	18	27	18	27
	<b>1B</b>	10	15	4	7	20	29	12	19	12	19
<b>Wirefill #2: One Twin-70 Channel with No Devices</b>	<b>2</b>	32	48	14	21	63	94	40	60	40	60
<b>Wirefill #3: Data Only using Device Bracket &amp; U.S. Standard Screw-On Faceplates</b>	<b>3</b>	19	29	8	13	38	57	24	36	24	36
<b>Wirefill #4: Power using Device Bracket &amp; U.S. Standard Screw-On Faceplates</b>	<b>4</b>	23	35	10	15	45	68	29	43	29	43
<b>Wirefill #5: Data Only using Snap-On Electrical/Communication Faceplates (with screw holes to mount a module frame)</b>	<b>5</b>	23	35	10	15	45	68	29	43	29	43
<b>Wirefill #6: 20A TVSS Rectangular Outlet using Device Bracket &amp; Snap-On Electrical/Communication faceplate Faceplate</b>	<b>6</b>	16	24	7	11	32	48	20	30	20	30

NOTE: See [page xiv-xv](#) for further explanation of wirefill data.

### Fill Capacity Table for: •Fiber Optic Cable (62.5/125mm) •Signal Cables

Raceway Channel Wirefill Configurations	See Fill #	Fiber Optic Cables (62.5/125mm)						Signal Cables							
		2 Strand		4 Strand		6 Strand		18AWG		20 AWG		22 AWG		24 AWG	
		DIA.=0.175		DIA.=0.175		DIA.=0.210		DIA.=0.066		DIA.=0.057		DIA.=0.050		DIA.=0.044	
		FILL		FILL		FILL		FILL		FILL		FILL		FILL	
		SPEC	MAX	SPEC	MAX	SPEC	MAX	SPEC	MAX	SPEC	MAX	SPEC	MAX	SPEC	MAX
<b>Wirefill #1: Power &amp; Data No Terminations</b>	<b>1A</b>	34	51	34	51	24	36	240	360	322	482	418	627	540	809
	<b>1B</b>	24	36	24	36	17	25	167	251	224	336	291	437	376	565
<b>Wirefill #2: One Twin-70 Channel with No Devices</b>	<b>2</b>	76	115	76	115	53	80	537	805	720	1080	936	1403	1208	1812
<b>Wirefill #3: Data Only using Device Bracket &amp; U.S. Standard Screw-On Faceplates</b>	<b>3</b>	46	69	46	69	32	48	327	491	438	658	570	855	736	1104
<b>Wirefill #4: Power using Device Bracket &amp; U.S. Standard Screw-On Faceplates</b>	<b>4</b>	55	83	55	83	38	58	388	583	521	781	677	1015	874	1311
<b>Wirefill #5: Data Only using Snap-On Electrical/Communication Faceplates (with screw holes to mount a module frame)</b>	<b>5</b>	55	83	55	83	38	58	388	583	521	781	677	1015	874	1311
<b>Wirefill #6: 20A TVSS Rectangular Outlet using Device Bracket &amp; Snap-On Electrical/Communication faceplate Faceplate</b>	<b>6</b>	39	58	39	58	27	40	273	409	365	548	475	712	613	920

NOTE: See [page xiv-xv](#) for further explanation of wirefill data.

### Raceway Cutting Instructions:

For small quantities, use a fine tooth handsaw. For larger quantities use a plastic cutting saw blade for clean, burr-free cuts. Recommend: *Carbide 80T or 100T; .090" thickness, .125" kerf.*

For Technical Assistance, call: 888-506-5400, Ext. 8287 (outside the U.S., see inside back cover for International Directory)

## Type T-70 & Twin-70 Raceway Accessories



T70DB-X



T70HB-X



T70HB3-X



T70WR-X



T70S-X

Part Number	Description	Color	Std. Pkg. Qty.	Std. Ctn. Qty.
-------------	-------------	-------	----------------	----------------

### Device Mounting Bracket

T70DB-X	Used to mount NEMA standard single gang electrical outlets and communication devices with either screw-on or snap-on single gang faceplates.	Gray	10 pcs.	100 pcs.
---------	----------------------------------------------------------------------------------------------------------------------------------------------	------	---------	----------

### Hanging Box

T70HB-X	Used to mount NEMA standard single gang electrical outlets and devices with either screw-on or snap-on single gang faceplates when there are communications cables in the raceway.	Gray	10 pcs.	100 pcs.
---------	------------------------------------------------------------------------------------------------------------------------------------------------------------------------------------	------	---------	----------

### Three Sided Hanging Box

T70HB3-X	Used to mount NEMA standard single gang electrical outlets and devices with either screw-on or snap-on single gang faceplates when there are communications cables in the raceway. No break-outs are required. Low profile increases capacity in raceway. For use with T70 raceway only.	Gray	10 pcs.	100 pcs.
----------	------------------------------------------------------------------------------------------------------------------------------------------------------------------------------------------------------------------------------------------------------------------------------------------	------	---------	----------

### Wire Retainer

T70WR-X	Holds wires in place. Will not interfere with cover installation.	Gray	10 pcs.	100 pcs.
---------	-------------------------------------------------------------------	------	---------	----------

### Surface Mount Box Spacer Plate

T70S-X	Spacer plate is used to mount a CBX4 Surface Mount Box onto the Device Bracket or Hanging Box shown above.	—	10 pcs.	100 pcs.
--------	------------------------------------------------------------------------------------------------------------	---	---------	----------

### ORDERING INFORMATION

Order number of pieces required, in multiples of Standard Package.



Using the spacer plate a CBX4 box can be mounted onto Twin-70 or T-70 raceway.



The CBX4 box features a fiber spool for managing fiber optic cable slack.

Note: Fiber spool optional. Not necessary for T-70 or Twin-70 raceway.

## T-70 Snap-On Fiber Spool Bracket



T70FSB

- Brackets are adjustable for slack length
- Maintains TIA/EIA 568-A and 569-A minimum 1" cable bend radius

Part Number	Description	Color	Std. Pkg. Qty.	Std. Ctn. Qty.
-------------	-------------	-------	----------------	----------------

### T-70 Snap-On Fiber Spool Bracket

T70FSB	Fiber spool bracket that snaps on to base of T-70. Provides method to contain 1m or more of fiber slack and provides strain relief. Maintains 1" bend radius for fiber optic cabling. Bracket distance can be adjusted to fit the length of slack required.	Gray	2 pcs.	50 pcs.
--------	-------------------------------------------------------------------------------------------------------------------------------------------------------------------------------------------------------------------------------------------------------------	------	--------	---------

### ORDERING INFORMATION:

Order number of pieces required, in multiples of Standard Package.

NOTE: Can only be used with T-70 base.

Contact Panduit for availability.



Use the T70FSB with T-70 raceway to contain 1m. or more of fiber slack and maintain a 1" cable bend radius.

## PAN-WAY™ LD Profile Raceways

**PAN-WAY** LD Profile Surface Raceways provide a complete system for routing and protecting premise cabling systems.

The five different LD profile raceway types have unique features that will match the raceway to the specific

needs of many different power and/or communications cabling applications.

A choice of standard low voltage, TIA/EIA 1" bend radius control, power rated and multi-channel fittings are available.

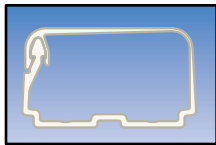

### Type LDP

- Extremely tamper resistant latch design for power & fiber-optic applications
- Excellent for school/university applications
- Hinge provides exceptional strength during impact & cutting

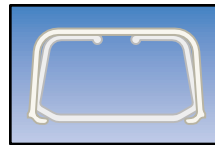

### Type CD

- Two piece design —base & cover
- Two base styles:
  - Adhesive Backed (smooth surfaces)
  - Screw Mounted Metal Bases (irregular surfaces)



### Type LD

- Wires are laid in instead of pulled through for quick & easy installations
- Hinge provides exceptional strength during impact & cutting
- Fast & easy installations
- New! 8 & 10 foot lengths for select styles of LD profile raceways

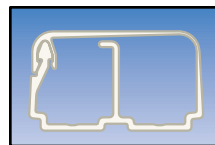

### Type LD2P

- Multi-channel raceway routes power & data together
- Excellent for office environments
- Extremely tamper-resistant
- Full complement of fittings, boxes & faceplates



### Type LDS

- Non-latching design is economical with unmatched tamper resistance
- Excellent for safety sensitive devices such as pay phones or security systems
- Bendable in low voltage applications to route around and over obstructions

**Table of Contents**

Page



**PAN-WAY™ Type LDP Surface Raceway**

Surface Raceway ..... C10  
 ① ② ③ ④ Configurations ..... C6-C7  
 Fill Capacities ..... C17-C18



**PAN-WAY Type LDS Surface Raceway**

Surface Raceway ..... C11  
 ① ② ③ ④ Configurations ..... C6-C7  
 Fill Capacities ..... C17-C18



**PAN-WAY Type LD Surface Raceway**

Surface Raceway ..... C12  
 ① ② ③ ④ Configurations ..... C6-C7  
 Fill Capacities ..... C17-C18



**PAN-WAY Type CD Surface Raceway**

Surface Raceway ..... C13  
 ① ② ③ ④ Configurations ..... C6-C7  
 Fill Capacities ..... C17-C18



**PAN-WAY Type LDP, LDS, LD & CD Fittings**

Standard Fittings ..... C14  
 1" Bend Radius Fittings ..... C14  
 600V Power Rated Fittings ..... C15



**PAN-WAY Type LD2P10 Surface Raceway**

Multi-Channel Surface Raceway ..... C16  
 Multi-Channel Fittings ..... C16  
 ① ② ③ ④ Configurations ..... C6-C7  
 Fill Capacities ..... C17-C18

**Additional Related Products**



**PAN-WAY Electrical Outlets** ..... A4



**PAN-WAY Surface Mount Outlet Boxes** ..... E3-E5



**PAN-WAY Faceplates** ..... A3-A4



**PAN-WAY Accessories** ..... H1

For Technical Assistance, call: 888-506-5400, Ext. 8287 (outside the U.S., see inside back cover for International Directory)

**PAN-WAY™ LD Profile Non-Metallic Raceways  
Data Only—Roadmap**

**SNAP-ON FACEPLATES**

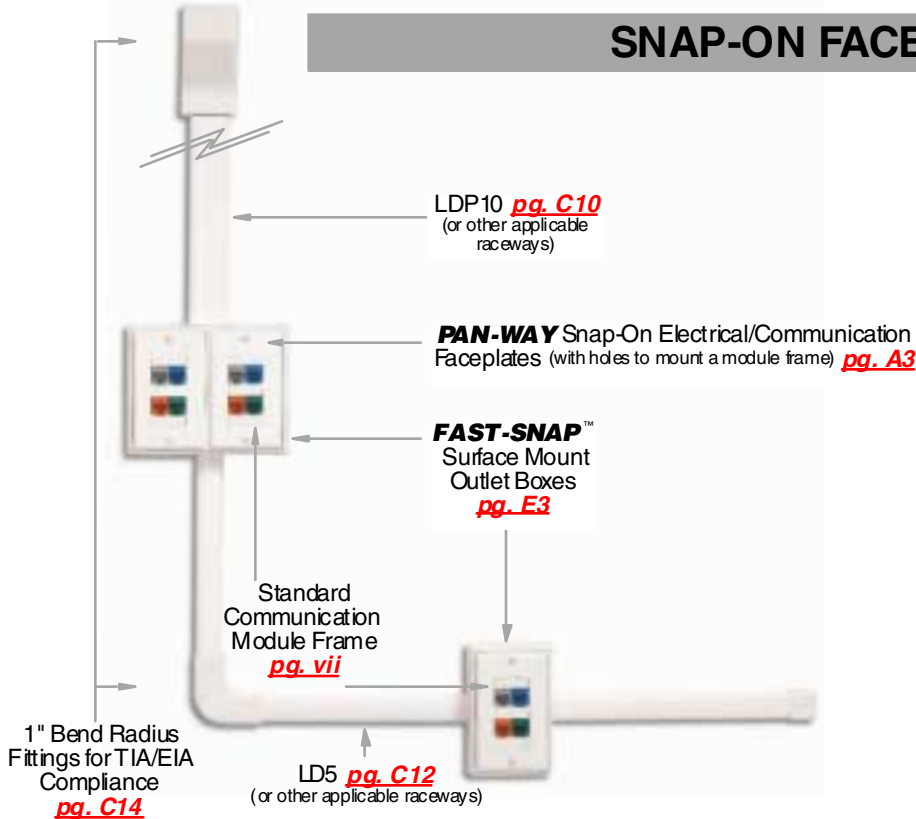

APPLICABLE RACEWAYS	
LDP <a href="#">pg. C10</a>	LD <a href="#">pg. C12</a>
LDS <a href="#">pg. C11</a>	CD <a href="#">pg. C13</a>

CONFIGURATIONS	
1	2
See <a href="#">page C6</a> thru <a href="#">C7</a>	

**SCREW-ON FACEPLATES**

APPLICABLE RACEWAYS	
LDP <a href="#">pg. C10</a>	LD <a href="#">pg. C12</a>
LDS <a href="#">pg. C11</a>	CD <a href="#">pg. C13</a>

  

CONFIGURATIONS	
3	4
See <a href="#">page C6</a> thru <a href="#">C7</a>	

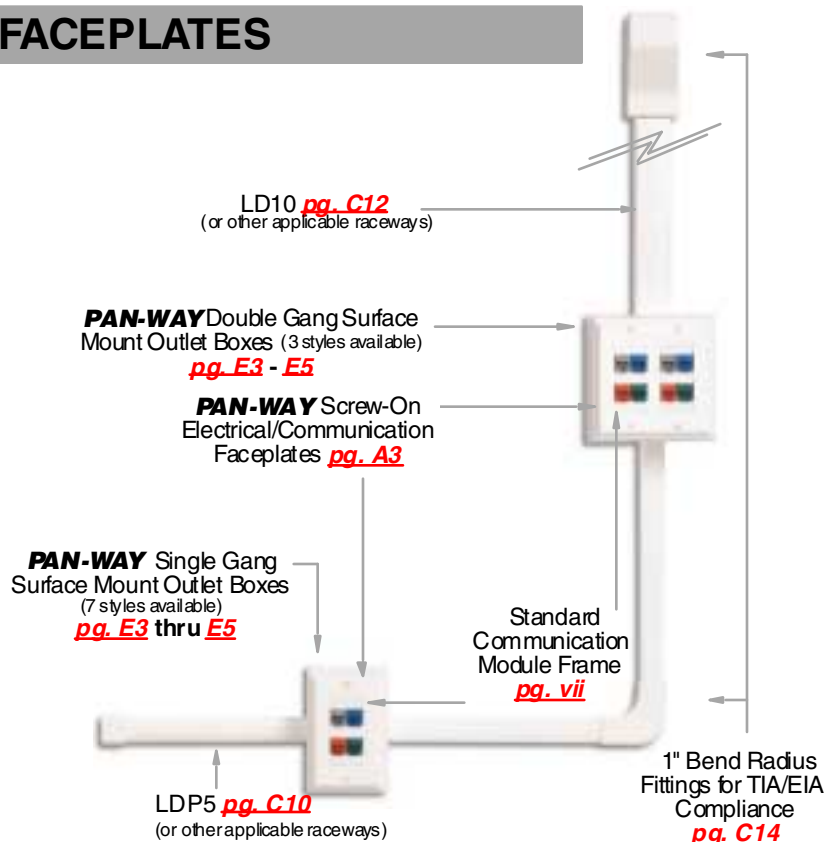

**PAN-WAY™ LD Profile Non-Metallic Raceways  
Power Only—Roadmap**

**SCREW-ON FACEPLATES**

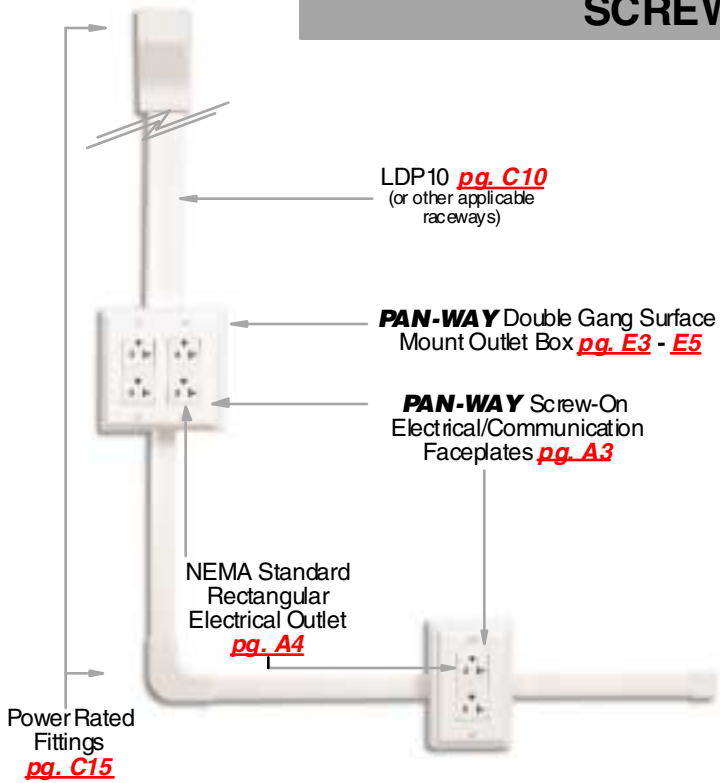

APPLICABLE RACEWAYS	
LDP <i>pg. C10</i>	LDS <i>pg. C11</i>

CONFIGURATIONS	
3	4
See <i>page C6</i> thru <i>C7</i>	

**OPTIONAL BOX STYLES**

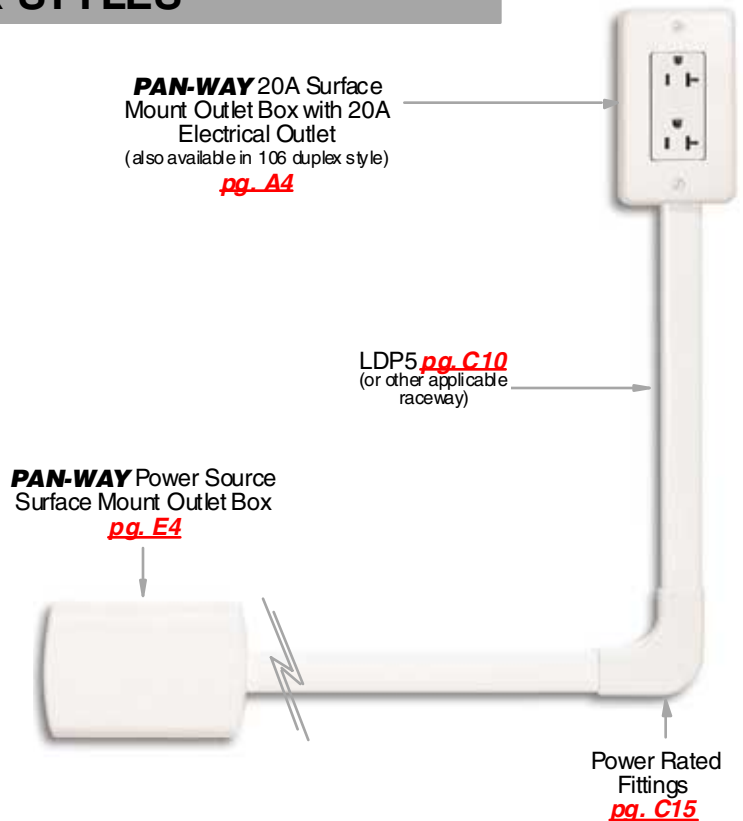

For Technical Assistance, call: 888-506-5400, Ext. 8287 (outside the U.S., see inside back cover for International Directory)

**PAN-WAY™ LD Profile Non-Metallic Raceways  
Data & Power—Roadmap**

**SNAP-ON FACEPLATES**

**APPLICABLE RACEWAYS**



**CONFIGURATIONS**



See [page C6](#) thru [C7](#)

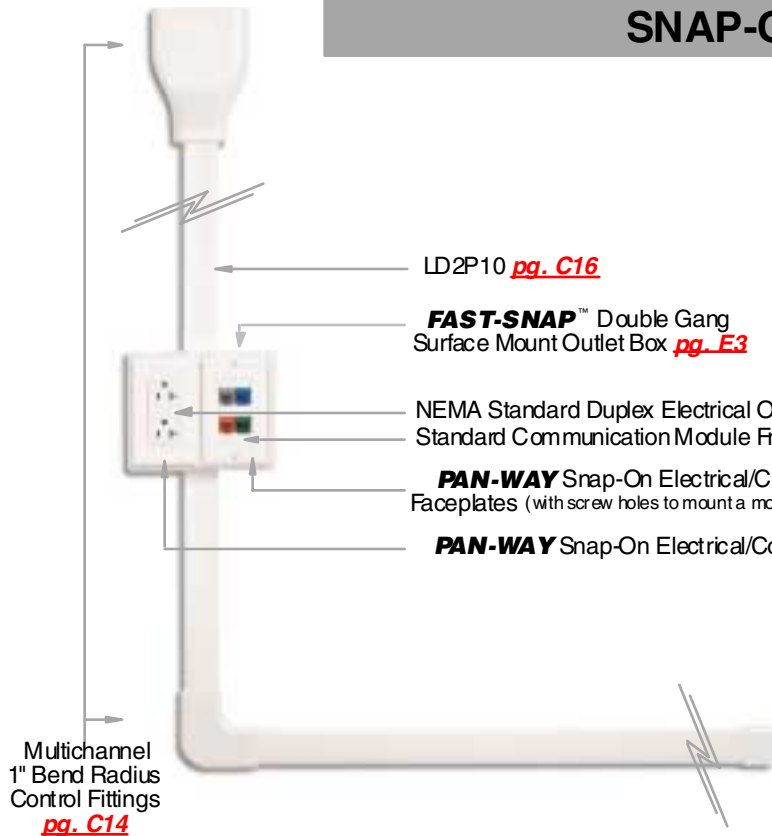

**SCREW-ON FACEPLATES**

**APPLICABLE RACEWAYS**



**CONFIGURATIONS**



See [page C6](#) thru [C7](#)

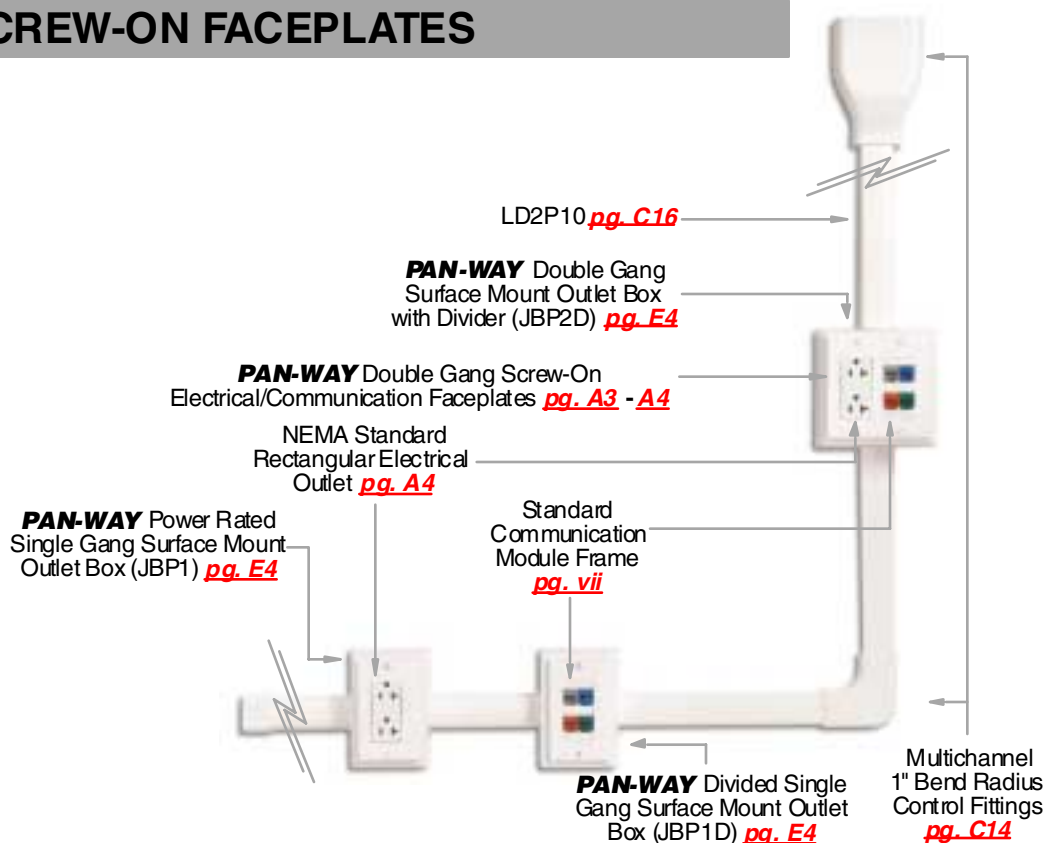

# PAN-WAY™ LD Raceway Configurations

**Application:** Routing low voltage cables and/or power cabling: Fiber Optic, Category 5, UTP, ScTP, Coax or any other low voltage cable; power cables (up to 600V) in horizontal applications.

LD PROFILE RACEWAY CONFIGURATIONS

## 1 PAN-WAY Snap-On Electrical/Communications Faceplates

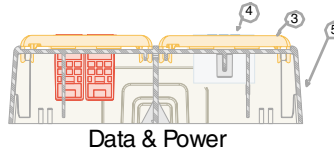
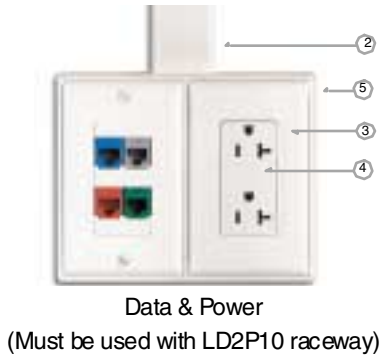

- Snap-On Faceplates provide a superior appearance
- **FAST-SNAP™** Boxes snap together for quick installation
- Data and Power box is divided to maintain separation

Components Required		Data (A)	Data (B)	Data & Power	See Page
1.	LDP/LD/LDS or CD Raceway	X	X		<a href="#">C10-C13</a>
2.	LD2P10 Multichannel Raceway			X	<a href="#">C16</a>
3.	Snap-On Electrical/Communication Faceplate(s)			X	<a href="#">A3</a>
4.	NEMA Standard Duplex Outlet			X	<a href="#">A4</a>
5.	Double Gang <b>FAST-SNAP</b> Outlet Box		X	X	<a href="#">E3</a>

Note: For data area(s) and fill capacity information see [page C17-C18](#)

## 2 PAN-WAY Snap-On Communication Faceplates (with screw holes to mount a module frame)

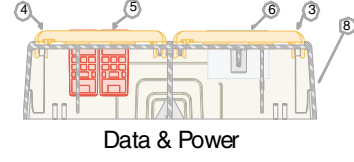
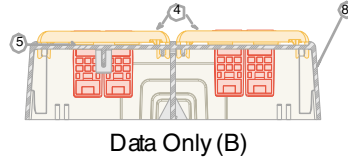
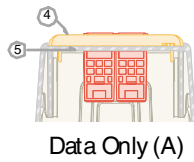

- Snap-On Faceplates provide a superior appearance
- Can use most manufacturers' communication module frames (see chart on [page vii](#))
- **FAST-SNAP™** Boxes snap together for quick installation
- Data and Power box is divided to maintain separation

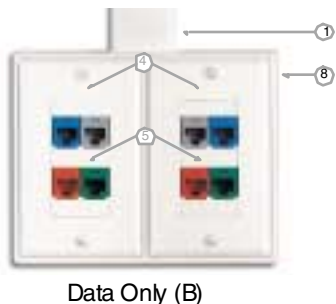
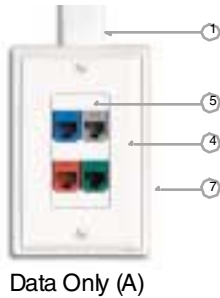

Components Required		Data (A)	Data (B)	Data & Power	See Page
1.	LDP/LD/LDS or CD Raceway	X	X		<a href="#">C10-C13</a>
2.	LD2P10 Multichannel Raceway			X	<a href="#">C16</a>
3.	Snap-On Electrical/Communication Faceplate(s)			X	<a href="#">A3</a>
4.	Snap-On Electrical/Communication Faceplate(s) (with screw holes to mount a module frame)	X	X	X	<a href="#">A3</a>
5.	Standard Communication Module Frame(s)	X	X	X	<a href="#">vii</a>
6.	NEMA Standard Duplex Outlet			X	<a href="#">A4</a>
7.	Single Gang <b>FAST-SNAP</b> Outlet Box	X			<a href="#">E3</a>
8.	Double Gang <b>FAST-SNAP</b> Outlet Box		X	X	<a href="#">E3</a>

Note: For data area(s) and fill capacity information see [page C17- C18](#)

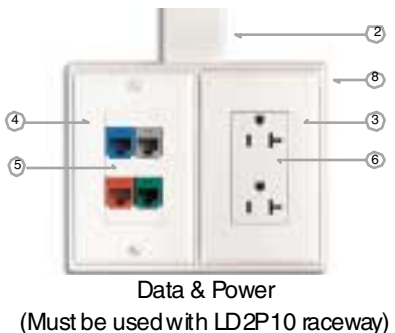



PAN-WAY™ LD Raceway Configurations Cont'd

3 PAN-WAY U.S. Standard Screw-On Electrical/Communication Faceplates

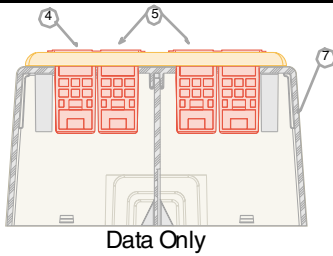

Data Only

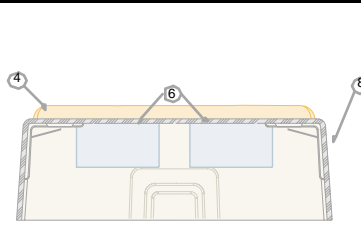

Power Only

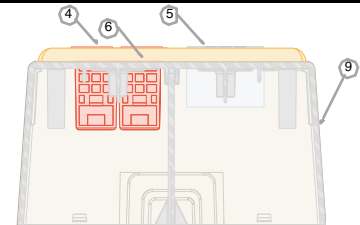

Data & Power

- Standard US screw-on electrical faceplate is used
- Can use most manufacturers' communication module frames (see chart on [page vii](#))

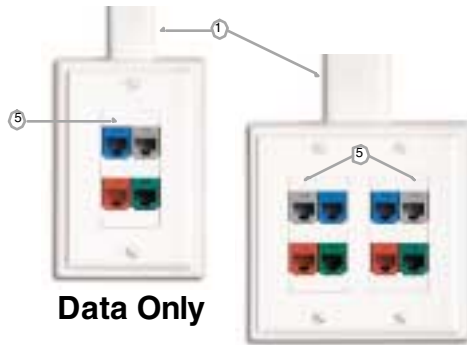

Data Only

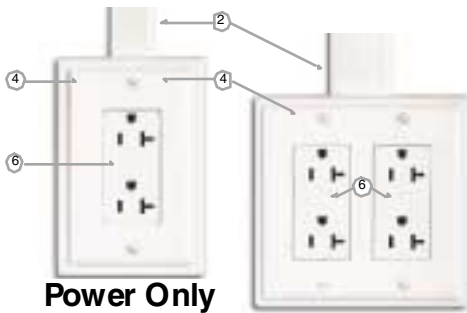

Power Only

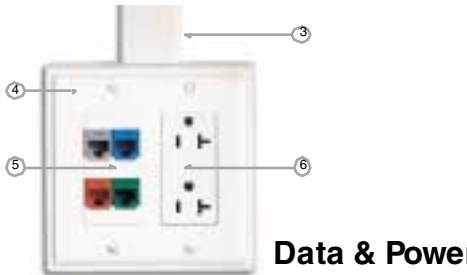

Data & Power

Components Required	Data Only	Power Only	Data & Power	See Page
1. LDP/LD/LDS or CD Raceway	X			<a href="#">C10C13</a>
2. LDP or LDS Raceway		X		<a href="#">C10C11</a>
3. LD2P10 Multichannel Raceway			X	<a href="#">C16</a>
4. U.S. Standard Screw-On Electrical/Communication Faceplate(s) (single or double gang available)	X	X	X	<a href="#">A3</a>
5. Standard Communication Module Frame(s)	X		X	<a href="#">vii</a>
6. NEMA Standard Rectangular Outlet(s)		X	X	<a href="#">A4</a>
7. Low Voltage Surface Mount Outlet Boxes (7 styles to choose from)	X			<a href="#">E3</a>
8. Power Rated Surface Mount Outlet Boxes (5 styles to choose from)		X		<a href="#">E4</a>
9. Divided Power Rated Surface Mount Outlet Boxes (3 styles to choose from)			X	<a href="#">E5</a>

Note: For data area(s) and fill capacity information see [page C17-C18](#)



Optional for Power



- Surface Mount Outlet Box includes box, 20A outlet and cover in duplex rectangular or 106 styles

Components Required	Power Only	See Page
1. LDP or LDS Raceway	X	<a href="#">C10-C11</a>
2. 20A Low Profile Rectangular or 106 Style Surface Mount Outlet Boxes (include box, 20A outlet & self cover)	X	<a href="#">A4</a>

4 U.S. Standard Screw-On Communication Faceplates

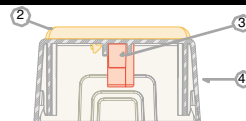
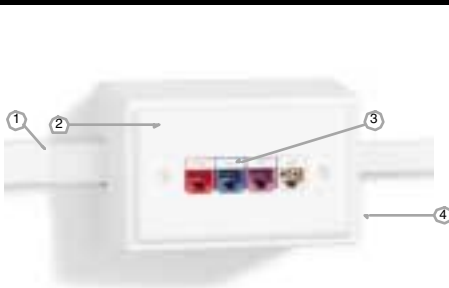

- Uses selected manufacturers' standard communication faceplates
- Panduit® Styles available, for more information refer to [page xii](#)

Components Required	Data Only	See Page
1. LDP/LD/LDS or CD Raceway	X	<a href="#">C10C13</a>
2. Most Mfg. U.S. Screw-On Standard Communication Faceplates (see page listed for Panduit styles)	X	—
3. Manufacturers' inserts and/or modules	X	—
4. Low Voltage Surface Mount Outlet Box (7 styles to choose from)	X	<a href="#">E3</a>

Note: For data area(s) and fill capacity information see [page C17-C18](#)

**PAN-WAY™ LD Profile Raceways—System Features**



See Configurations 2 - 4 on previous page

LDP Raceway [pg. C10](#)

LDP raceway is part of our **FIBER-SPEC™** raceway family. **FIBER-SPEC** raceways are designed specifically for high performance structured cabling systems. They provide the TIA/EIA required bend radius, security/tamper resistance, and access to the required one meter of fiber slack.



JBP1 [pg. E4](#)

The standard depth power surface mount outlet box provides a durable, secure way of mounting electrical devices and faceplates.



JB1D [pg. E3](#)

The deep one-piece surface mount outlet box provides the extra space needed to maintain the TIA/EIA required bend radius.



1" Bend Radius Fittings [pg. C14](#)

The unique right angle entrance end fitting allows cables to enter through the wall into the raceway, while maintaining the TIA/EIA required bend radius.



LD2P Raceway [pg. C16](#)

See Configurations 2 - 4 on previous page

New! multichannel LD2P10 is a convenient way to route both power and data cables to a computer work station. It provides lowest installed cost by eliminating the need for multiple boxes and faceplates.



The New! Double Gang Divided Surface Mount Outlet Boxes when used with module frames place data & power outlets at the same convenient location.

**PAN-WAY™ LD Profile Raceways—System Features**

1" Bend Radius Fittings [C.14](#)



LDS Raceway [pg. C.11](#)

The Drop Ceiling/Entrance End fitting allows for a transition out of the ceiling and into any LD Profile raceway (LDS5 shown) without having to cut the metal ceiling support.



LD Profile raceways may be used in a variety of applications including fire alarms, security, emergency lighting and power. (LDS3 & LDS5 raceway shown)



LDS Raceway [pg. C.11](#)

The LDS can be transitioned to and from LDP (as shown above) to get around obstacles on the wall.

The one-piece Type LDS raceway is **bendable** and allows you to get around obstacles such as conduit, existing raceway, mouldings, and offsets in the wall (in low voltage applications.)

LDS has the same external dimensions as all the LD Profile raceways and works with the same fittings. This allows for the transition to LDS, bend around the object, then transition back to LD, LDP, or CD.

See Configuration 3 [pg. C.7](#)

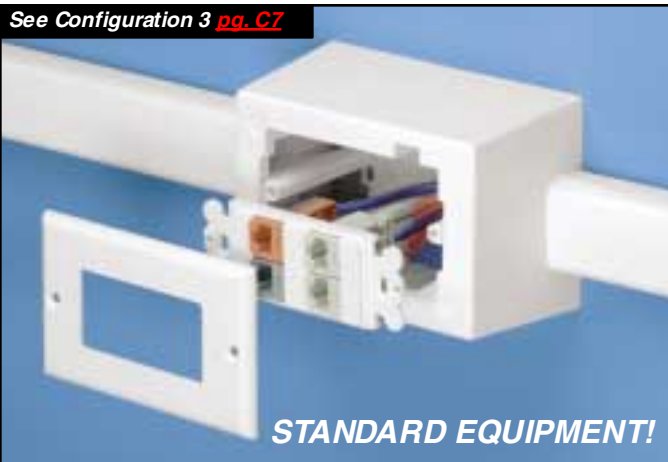

As with all Panduit Raceways standard devices and faceplates are readily accepted.

See Configuration 2 [pg. C.6](#)



Our New **FAST-SNAP™** Surface Mount Outlet Boxes accept **PAN-WAY** Snap-On Faceplates to provide lowest installed cost.

## PAN-WAY™ Type LDP Surface Raceway

**PAN-WAY** Type LDP Surface Raceway is a single channel raceway designed to route, protect and conceal data, voice, video, fiber-optic or power cabling.

### Type LDP Raceway Benefits:

- Power rated to 600V (UL), 300V (CSA). Meets **New! UL5A** and CSA 22.2 No. 62-93 standards
- Extremely tamper resistant latch for School & University applications
- One-piece hinged design allows cables to be laid in
- Factory applied adhesive backing speeds installation
- **NEW!** Now FT-4 Rated for Canada

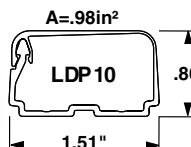
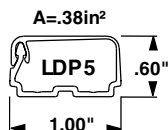
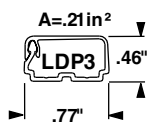

Part Number	Std. Ctn. Qty.	Part Number	Std. Ctn. Qty.	Colors <sup>1</sup>
<b>8 ft. lengths</b>		<b>10 ft. lengths</b>		
<b>LDP3—Surface Raceway</b>				
LDP3IW8-A	160ft.	LDP3IW10-A	200ft.	Off White
<b>LDP5—Surface Raceway</b>				
LDP5IW8-A	160ft.	LDP5IW10-A	200ft.	Off White
<b>LDP10—Surface Raceway</b>				
LDP10IW8-A	160ft.	LDP10IW10-A	200ft.	Off White

Tamper resistant one-piece latching surface raceway. Supplied with pre-applied adhesive backed tape.

**NOTE:** LDP Raceway requires screw mounting if it is being used for power cabling applications.  
<sup>1</sup> All parts listed in Off White (IW) color. To order other colors substitute EI (Electric Ivory), IG (Light Gray), WH (White), and BR (Brown). Contact factory for details.

**ORDERING INFORMATION**  
 Order number of feet required, in multiples of Standard Length Increment.  
 See [page C14-C15](#) for fittings

### LD/LDP/LD2P Raceway Installation Tool



Part Number	Description	Std. Pkg. Qty.	Std. Ctn. Qty.
<b>LDP Raceway Installation Tool</b>			
LDW3-V	Optional installation tool for use with Type LD3/LDP3 raceways.	Serves as guide for drill bit in screw mount applications. Holds LD/LDP/LD2P raceway cover open during installation	5 pcs.
LDW5-V	Optional installation tool for use with Type LD5/LDP5 raceways.		50 pcs.
LDW10-V	Optional installation tool for use with Type LD10/LDP10/LD2P10 raceways.		50 pcs.

**ORDERING INFORMATION:**  
 Order number of pieces required, in multiples of Standard Package.

### Optional Mounting Method



Raceway mounts easily to smooth, clean interior surfaces, however, not all surfaces are suitable for adhesive mounting. In these applications, use the foam tape as a temporary mounting means. Insert the raceway installation tool to facilitate screw installation.

## PAN-WAY™ Type LDS Surface Raceway

**PAN-WAY** Type LDS Surface Raceway is a single channel, solid one-piece, economical raceway designed to route, protect and conceal data, voice, video or power cabling.

### Type LDS Raceway Benefits:

- Power rated to 600V(UL), 300V(CSA). Meets **New! UL5A** and CSA 22.2 No. 62-93 standards
- NEW! Now FT-4 Rated for Canada
- Type LDS is **the only non-metallic raceway that is bendable** in low voltage applications to route around and over obstructions
- Extreme tamper resistance
- Factory applied adhesive backing speeds installation



LDS3

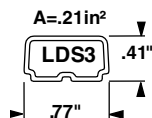

LDS5

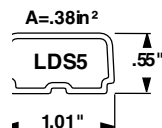

Part Number	Description	Std. Ctn. Qty.	Colors <sup>u</sup>
<b>10 ft. lengths</b>			

#### LDS3—Surface Raceway

LDS3IW10-A	Tamper resistant one-piece surface raceway. Supplied with pre-applied adhesive backed tape.	200 ft.	Off White
------------	---------------------------------------------------------------------------------------------	---------	-----------

#### LDS5—Surface Raceway

LDS5IW10-A	Tamper resistant one-piece surface raceway. Supplied with pre-applied adhesive backed tape.	200 ft.	Off White
------------	---------------------------------------------------------------------------------------------	---------	-----------

<sup>u</sup> All parts listed in Off White (IW) color. To order other colors substitute EI (Electric Ivory), IG (Light Gray), and WH (White). Contact factory for details.

**NOTE:** LDS Raceway requires screw mounting using the LMD Mounting Straps if it is being used for power cabling applications.

**NOTE 2:** LMD Mounting Straps are recommended in low voltage applications for use near a bend in Type LDS raceway.

#### ORDERING INFORMATION:

Order number of feet required, in multiples of Standard Length Increment.

See [page C14-C15](#) for fittings

### Method for Bending Type LDS Raceway (Low Voltage Applications)



**Step 1:** Slide 18 to 30" section of LDS Raceway into PVC pipe heating blanket.\* (Recommend blanket designed for bending 1/2" to 1 1/2" PVC conduit.)

\*Heating blanket not provided by Panduit®



**Step 2:** Allow section to heat approximately 2-3 minutes. Raceway will be soft and pliable but should not stretch. (Time will vary with blanket temperature and raceway size.)



**Step 3:** Remove raceway section from blanket and hold in desired position until the raceway cools. Install mounting straps immediately.

### Accessories — Mounting Straps



- Straps are made of 94V-0 impact resistant ABS/polycarbonate material
- Wide enough to be used as coupler between raceway sections

Part Number	Used with LDS & LDP Size	Description	Colors <sup>u</sup>	Std. Pkg Qty.	Std. Ctn. Qty.
-------------	--------------------------	-------------	---------------------	---------------	----------------

#### LMD—Mounting Straps

LMD3IW-Q	Size 3	Mounted to raceway when running power cables to provide complete tamper resistance and comply with UL listing requirements.	Off White	25 pcs.	100 pcs.
LMD5IW-Q	Size 5		Off White	25 pcs.	100 pcs.

<sup>u</sup> All parts listed in Off White (IW) color. To order other colors substitute EI (Electric Ivory), IG (Light Gray), and WH (White). Contact factory for details.

#### ORDERING INFORMATION:

Order number of pieces required, in multiples of Standard Package.

**PAN-WAY™ Type LD Surface Raceway**

**PAN-WAY** Type LD Surface Raceway is a single channel raceway designed to route, protect and conceal data, voice and video cabling.

**Type LD Raceway Benefits:**

- One-piece hinged design allows cables to be laid in
- NEW! Now FT-4 Rated for Canada
- Factory applied adhesive backing speeds installation



LD3

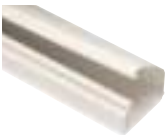
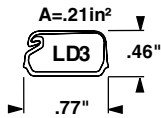

LD5

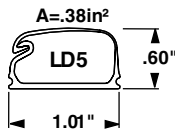

LD10

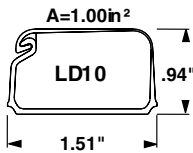

Part Number	Std. Ctn. Qty.	Part Number	Std. Ctn. Qty.	Part Number	Std. Ctn. Qty.	Colors <sup>u</sup>
-------------	----------------	-------------	----------------	-------------	----------------	---------------------

**LD3—Surface Raceway**

6 ft. lengths		8 ft. lengths		10 ft. lengths		
LD3IW6-A	120 ft.	LD3IW8-A	160 ft.	LD3IW10-A	200 ft.	Off White

One-piece latching surface raceway. Supplied with pre-applied adhesive backed tape.

<sup>u</sup> All parts listed in Off White (IW) color. To order other colors substitute EI (Electric Ivory), IG (Light Gray), WH (White), and BR (Brown). Contact factory for details.

**LD5—Surface Raceway**

6 ft. lengths		8 ft. lengths		10 ft. lengths		
LD5IW6-A	120 ft.	LD5IW8-A	160 ft.	LD5IW10-A	200 ft.	Off White

One-piece latching surface raceway. Supplied with pre-applied adhesive backed tape.

<sup>u</sup> All parts listed in Off White (IW) color. To order other colors substitute EI (Electric Ivory), IG (Light Gray), WH (White), BR (Brown), and BL (Black). Contact factory for details.

**LD10—Surface Raceway**

6 ft. lengths		8 ft. lengths		10 ft. lengths		
LD10IW6-A	120 ft.	LD10IW8-A	160 ft.	LD10IW10-A	200 ft.	Off White

One-piece latching surface raceway. Supplied with pre-applied adhesive backed tape.

<sup>u</sup> All parts listed in Off White (IW) color. To order other colors substitute EI (Electric Ivory), IG (Light Gray), WH (White), and BR (Brown). Contact factory for details.

**ORDERING INFORMATION:**

Order number of feet required, in multiples of Standard Length Increment.

See [page C14-C15](#) for fittings

## PAN-WAY™ Type CD Surface Raceway

**PAN-WAY** Type CD Surface Raceway is a single channel, two-piece raceway, designed to route, protect and conceal data, voice and video cabling.

### Type CD Raceway Benefits:

- Unique base design allows wires to be laid in
- NEW! Now FT-4 Rated for Canada
- Factory applied adhesive backing on base speeds installation



### CD Surface Raceway Cover—6 ft Lengths

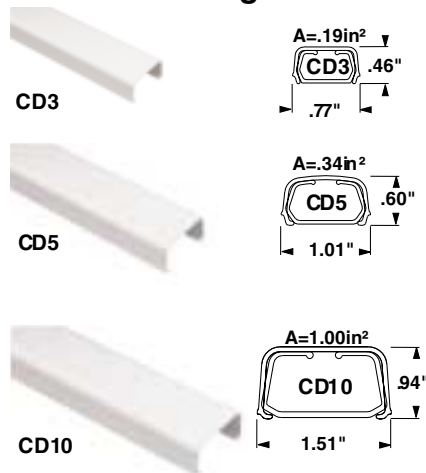

Part Number	Description	Colors <sup>u</sup>	Std. Length	Std. Ctn. Qty.
-------------	-------------	---------------------	-------------	----------------

#### CD—Raceway Cover

<b>CD3IW6</b>	Cover of two-piece raceway. Covers snap onto adhesive backed bases.	Off White	6 ft.	120ft.
<b>CD5IW6</b>	Cover of two-piece raceway. Covers snap onto adhesive backed bases. This size also snaps onto screw mounted metal base below.	Off White	6 ft.	120ft.
<b>CD10IW6</b>	Cover of two-piece raceway. Covers snap onto adhesive backed bases. This size also snaps onto screw mounted metal base below.	Off White	6 ft.	120ft.

<sup>u</sup> All parts listed in Off White (IW) color. To order Electrical Ivory substitute EI for IW in above part numbers. Contact factory for details.

**ORDERING INFORMATION:**  
Order number of feet required, in multiples of Standard Length Increment.

### CD Surface Raceway Base—6 ft Lengths, Short Pieces & Metal Base Clips



CDB



CDC

Part Number	Used with Raceway Cover	Description	Std. Length	Std. Ctn. Qty.
-------------	-------------------------	-------------	-------------	----------------

#### CD—6' Lengths Adhesive Backed Base (for mounting on smooth surfaces)

<b>CDB36-A</b>	CD3	For increased adhesion and impact resistance. Cables are laid into base prior to the cover being snapped on.	6 ft.	120ft.
<b>CDB56-A</b>	CD5			
<b>CDB106-A</b>	CD10			

#### CD—Short Pieces Adhesive Backed Base

<b>CDB3S-A-L</b>	CD3	For lighter loads. Cables are laid into base prior to the cover being snapped on. Recommended minimum of 4 pieces for each 6 feet of cover.	1.5 in.	50 pcs.
<b>CDB5S-A-L</b>	CD5		2.0 in.	
<b>CDB10S-A-L</b>	CD10		2.0 in.	

#### CD—Screw Mounted Metal Base Clips (For mounting on uneven surfaces)

<b>CDC5-L</b>	CD5	Cables are laid into base clips prior to the cover being snapped on. Recommended minimum of 4 pieces per each 6 feet of cover. <i>Recommend #6 or #8 screw</i>	—	50 pcs.
<b>CDC10-L</b>	CD10			

**ORDERING INFORMATION:**  
Order number of feet/pieces required in multiples of Standard Length Increment or Standard Carton Quantity.

See [page C14-C15](#) for fittings

**Standard Fittings for Low Voltage Applications**



Description	Part Number	Std. Pkg. Qty.	Part Number	Std. Pkg. Qty.	Part Number	Std. Pkg. Qty.	Colors <sup>u</sup>	Std. Ctn. Qty.
Coupler Fitting	CF3IW-E	20 pcs.	CF5IW-E	20 pcs.	CF10IW-X	10 pcs.	Off White	100 pcs.
Inside Corner Fitting	ICF3IW-E	20 pcs.	ICF5IW-E	20 pcs.	ICF10IW-X	10 pcs.	Off White	100 pcs.
Outside Corner Fitting	OCF3IW-E	20 pcs.	OCF5IW-E	20 pcs.	OCF10IW-X	10 pcs.	Off White	100 pcs.
Right Angle Fitting	RAF3IW-E	20 pcs.	RAF5IW-E	20 pcs.	RAF10IW-X	10 pcs.	Off White	100 pcs.
End Cap Fitting	ECF3IW-E	20 pcs.	ECF5IW-E	20 pcs.	ECF10IW-X	10 pcs.	Off White	100 pcs.
Tee Fitting	TF3IW-E	20 pcs.	TF5IW-E	20 pcs.	TF10IW-X	10 pcs.	Off White	100 pcs.
Drop Ceiling/ Entrance End	DCF3IW-X	10 pcs.	DCF5IW-X	10 pcs.	DCF10IW-X	10 pcs.	Off White	100 pcs.
Reducer Fitting	RF5X3IW-E	20 pcs.	RF10X5IW-X	10 pcs.	RF10X3IW-X	10 pcs.	Off White	100 pcs.

<sup>u</sup> All parts listed in Off White (IW) color. To order other colors substitute EI (Electric Ivory), IG (Light Gray), WH (White), and BR (Brown). BL (Black) is also available in Size 5 ONLY. Contact factory for details.

**ORDERING INFORMATION:**

Order number of pieces required, in multiples of Standard Package.

**1" Bend Radius Fittings for TIA/EIA Compliance**



Description	Part Number	Std. Pkg. Qty.	Part Number	Std. Pkg. Qty.	Part Number	Std. Pkg. Qty.	Colors <sup>u</sup>	Std. Ctn. Qty.
Coupler Fitting	CFX3IW-X	10 pcs.	CFX5IW-X	10 pcs.	CFX10IW-X	10 pcs.	Off White	100 pcs.
Inside Corner Fitting	ICFC3IW-X	10 pcs.	ICFC5IW-X	10 pcs.	ICFC10IW-X	10 pcs.	Off White	100 pcs.
Outside Corner Fitting	OCFX3IW-X	10 pcs.	OCFX5IW-X	10 pcs.	OCFX10IW-X	10 pcs.	Off White	100 pcs.
Right Angle Fitting	RAFC3IW-X	10 pcs.	RAFC5IW-X	10 pcs.	RAFC10IW-X	10 pcs.	Off White	100 pcs.
End Cap Fitting	ECFX3IW-X	10 pcs.	ECFX5IW-X	10 pcs.	ECFX10IW-X	10 pcs.	Off White	100 pcs.
Tee Fitting	TFC3IW-X	10 pcs.	TFC5IW-X	10 pcs.	TFC10IW-X	10 pcs.	Off White	100 pcs.
Drop Ceiling/ Entrance End	DCEFXIW-X	10 pcs.	DCEFXIW-X	10 pcs.	DCEFXIW-X	10 pcs.	Off White	100 pcs.
Right Angle Entrance End	RAEFXIW-X	10 pcs.	RAEFXIW-X	10 pcs.	RAEFXIW-X	10 pcs.	Off White	100 pcs.
Reducer Fitting	RFX53IW-X	10 pcs.	RFX105IW-X	10 pcs.	RFX103IW-X	10 pcs.	Off White	100 pcs.

<sup>u</sup> All parts listed in Off White (IW) color. To order other colors substitute EI (Electric Ivory), IG (Light Gray), WH (White), and BR (Brown). BL (Black) is also available in select Size 5 Fittings ONLY. Contact factory for details.

**ORDERING INFORMATION:**

Order number of pieces required, in multiples of Standard Package.





## Power Rated Fittings for Power to 600V



Description	Part Number	Std. Pkg. Qty.	Part Number	Std. Pkg. Qty.	Part Number	Std. Pkg. Qty.	Colors <sup>u</sup>	Std. Ctn. Qty.
Coupler Fitting	CFX3IW-X	10 pcs.	CFX5IW-X	10 pcs.	CFX10IW-X	10 pcs.	Off White	100 pcs.
Inside Corner Fitting	ICFX3IW-X	10 pcs.	ICFX5IW-X	10 pcs.	ICFX10IW-X	10 pcs.	Off White	100 pcs.
Outside Corner Fitting	OCFC3IW-X	10 pcs.	OCFC5IW-X	10 pcs.	OCFC10IW-X	10 pcs.	Off White	100 pcs.
Right Angle Fitting	RAFX3IW-X	10 pcs.	RAFX5IW-X	10 pcs.	RAFX10IW-X	10 pcs.	Off White	100 pcs.
End Cap Fitting	ECFX3IW-X	10 pcs.	ECFX5IW-X	10 pcs.	ECFX10IW-X	10 pcs.	Off White	100 pcs.
Tee Fitting	TFX3IW-X	10 pcs.	TFX5IW-X	10 pcs.	TFX10IW-X	10 pcs.	Off White	100 pcs.
Drop Ceiling/ Entrance End	DCEFXIW-X	10 pcs.	DCEFXIW-X	10 pcs.	DCEFXIW-X	10 pcs.	Off White	100 pcs.
Right Angle Entrance End	RAEFXIW-X	10 pcs.	RAEFXIW-X	10 pcs.	RAEFXIW-X	10 pcs.	Off White	100 pcs.
Reducer Fitting	RFX53IW-X	10 pcs.	RFX105IW-X	10 pcs.	RFX103IW-X	10 pcs.	Off White	100 pcs.

<sup>u</sup> All parts listed in Off White (IW) color. To order other colors substitute EI (Electric Ivory), IG (Light Gray), WH (White), and BR (Brown). BL (Black) is also available in select Size 5 Fittings ONLY. Contact factory for details.

### ORDERING INFORMATION:

Order number of pieces required, in multiples of Standard Package.

Maintains TIA/EIA 568-A and 569-A minimum 1" cable bend radius

## PAN-WAY™ Type LD2P Multi-Channel Surface Raceway

**PAN-WAY** Type LD2P Surface Raceway is a two channel raceway designed to route, protect and conceal data, voice, video, fiber-optic and power cabling.

### Type LD2P Raceway Benefits:

- Power rated to 600V(UL), 300V(CSA). Meets **New! UL5A** and CSA 22.2 No. 62-93 standards
- NEW! Now FT-4 Rated for Canada
- Routes Power & Data together!
- Extremely tamper resistant latch for School & University applications
- One-piece hinged design allows cables to be laid in
- Factory applied adhesive backing speeds installation

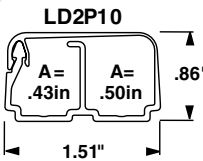
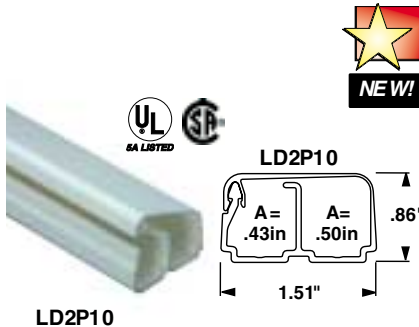

Part Number	Std. Ctn. Qty.	Part Number	Std. Ctn. Qty.	Colors <sup>u</sup>
-------------	----------------	-------------	----------------	---------------------

8 ft. lengths		10 ft. lengths		
LD2P10IW8-A	160ft.	LD2P10IW10-A	200ft.	Off White

Two channel tamper resistant one-piece latching surface raceway. Supplied with pre-applied adhesive backed tape.

**NOTE:** LD2P Raceway requires screw mounting if it is being used for power cabling applications  
<sup>u</sup> All parts listed in Off White (IW) color. To order other colors substitute EI (Electric Ivory), IG (Light Gray), WH (White), and BR (Brown). Contact factory for details.

**ORDERING INFORMATION:**  
 Order number of feet required, in multiples of Standard Length Increment.  
 See [page C10](#) for LDW10-V Installation Tool.



## Multi-Channel Fittings for Multi-Channel Power & Low Voltage Applications



Part Number	Description	Colors <sup>u</sup>	Std. Pkg. Qty.	Std. Ctn. Qty.
CFX10IW-X	Coupler Fitting	Off White	10 pcs.	100 pcs.
ICFX10IW-X	Inside Corner Fitting	Off White	10 pcs.	100 pcs.
OCFX10IW-X	Outside Corner Fitting	Off White	10 pcs.	100 pcs.
RAFX10IW-X	Right Angle Fitting	Off White	10 pcs.	100 pcs.
ECFX10IW-X	End Cap Fitting	Off White	10 pcs.	100 pcs.
TFXD10IW-X	Tee Fitting with Divided Insert	Off White	10 pcs.	100 pcs.
EEFXIW	Entrance End Fitting	Off White	1 pc.	10 pcs.

<sup>u</sup> All parts listed in Off White (IW) color. To order other colors substitute EI (Electric Ivory), IG (Light Gray), WH (White), and BR (Brown). Contact factory for details.

**ORDERING INFORMATION:**  
 Order number of pieces required, in multiples of Standard Package.

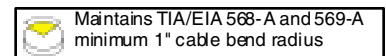

## Fill Capacities for LD Profile Raceways

This information is to be used as a guide in selecting the proper size raceway. The maximum amounts may vary according to the wire installation methods, straightness of wires, etc.



LDP3 .21 in <sup>2</sup>	LDP5 .38 in <sup>2</sup>	LDP10 .98 in <sup>2</sup>
-----------------------------	-----------------------------	------------------------------



LD2P10-Lft. .43 in <sup>2</sup>	LD2P10-Rgt. .50 in <sup>2</sup>
------------------------------------	------------------------------------



LD3 .21 in <sup>2</sup>	LD5 .38 in <sup>2</sup>	LD10 1.00 in <sup>2</sup>
----------------------------	----------------------------	------------------------------



LDS3 .21 in <sup>2</sup>	LDS5 .38 in <sup>2</sup>
-----------------------------	-----------------------------



CD3 .17 in <sup>2</sup>	CD5 .33 in <sup>2</sup>	CD10 .78 in <sup>2</sup>
----------------------------	----------------------------	-----------------------------

**SPEC=40% wirefill**—the recommended design in cable capacity. Leaves room for future moves, adds and changes

**MAX=60% wirefill**—the maximum cable quantity based on cable interweaving and packing factors or UL temp. rise test (electrical)

### Fill Capacity Table for: ·Electrical ·Voice Grade 24 AWG UTP ·Data Grade 24 AWG UTP

Raceway Type	Electrical Cables			Voice Grade Cables						Data Grade Cables			
	14	12	10	24 AWG UTP CM/CMR						24 AWG/UTP CM			
	THHN/T90			2 pr		3 pr		4 pr		25 pr		Cat. 5 4 pr	
	0.105	0.122	0.153	DIA.=0.120		DIA.=0.150		DIA.=0.190		DIA.=0.422		DIA.=0.217	
	FILL			FILL		FILL		FILL		FILL		FILL	
	MAX	MAX	MAX	SPEC	MAX	SPEC	MAX	SPEC	MAX	SPEC	MAX	SPEC	MAX
LD3	•	•	•	7	11	4	7	2	4	—	—	2	3
LD5	•	•	•	13	20	8	12	5	8	1	1	4	6
LD10	•	•	•	35	53	22	33	14	21	2	4	10	16
LDP3	9	6	4	7	11	4	7	2	4	—	—	2	3
LDP5	10	8	5	13	20	8	12	5	8	1	1	4	6
LDP10*	12	7	5	34	51	22	33	14	20	2	4	10	15
LD2P10-Left Channel	14	11	8	15	22	9	14	6	9	1	1	4	6
LD2P10-Rgt. Channel	**	**	**	17	26	11	16	7	10	1	2	5	8
LDS3	9	6	4	7	11	4	7	2	4	—	—	2	3
LDS5	10	8	5	13	20	8	12	5	8	1	1	4	6
CD3	•	•	•	6	9	3	5	2	3	—	—	1	2
CD5	•	•	•	11	17	7	11	4	6	—	1	3	5
CD10	•	•	•	27	41	17	20	11	16	2	3	8	12

\* LDP10 raceway not approved for use with T90 wire; NOTE: See [page xiv-xv](#) for further explanation of wirefill data.

\*\* Not power configuration; • Not power rated

### Fill Capacity Table for: ·Data Grade 22 AWG UTP ·Data Grade 24, 22 AWG STP ·Type 1A STP

Raceway Type	Data Grade Cables															
	24 AWG				22 AWG											
	STP CM				UTP CM					STP CM					Type 1A 22 AWG STP CM	
	25 pr		4 pr		25 pr		4 pr			25 pr		4 pr				
	DIA.=0.512		DIA.=0.250		DIA.=0.544		DIA.=0.234			DIA.=0.635		DIA.=0.286			DIA.=0.430	
	SPEC	MAX	SPEC	MAX	SPEC	MAX	SPEC	MAX	SPEC	MAX	SPEC	MAX	SPEC	MAX	SPEC	MAX
LD3	—	—	1	2	—	—	1	2	—	—	1	1	—	—	—	—
LD5	—	1	2	4	—	—	3	5	—	—	2	3	1	1	—	—
LD10	1	2	8	12	1	2	9	13	1	1	6	9	2	4	—	—
LDP3	—	—	1	2	—	—	1	2	—	—	1	1	—	—	—	—
LDP5	—	1	2	4	—	—	3	5	—	—	2	3	1	1	—	—
LDP10*	1	2	7	11	1	2	9	13	1	1	6	9	2	3	—	—
LD2P10-Left Channel	—	1	3	5	—	2	3	5	—	—	2	4	1	1	—	—
LD2P10-Rgt. Channel	—	1	4	6	—	1	4	6	—	—	3	4	1	2	—	—
LDS3	—	—	1	2	—	—	1	2	—	—	—	1	—	—	—	—
LDS5	—	1	2	4	—	—	3	5	—	—	2	3	—	—	—	—
CD3	—	—	1	2	—	—	1	2	—	—	1	1	—	—	—	—
CD5	—	—	2	4	—	—	3	4	—	—	2	3	—	1	—	—
CD10	1	2	6	9	1	2	7	10	—	1	4	7	2	3	—	—

NOTE: See [page xiv-xv](#) for further explanation of wirefill data.

For Technical Assistance, call: 888-506-5400, Ext. 8287 (outside the U.S., see inside back cover for International Directory)

### Fill Capacities for LD Profile Raceways

This information is to be used as a guide in selecting the proper size raceway. The maximum amounts may vary according to the wire installation methods, straightness of wires, etc.



LDP3 .21 in <sup>2</sup>	LDP5 .38 in <sup>2</sup>	LDP10 .98 in <sup>2</sup>
-----------------------------	-----------------------------	------------------------------

LD2P10-L.ft. .43 in <sup>2</sup>	LD2P10-Rgt. .50 in <sup>2</sup>
-------------------------------------	------------------------------------

LD3 .21 in <sup>2</sup>	LD5 .38 in <sup>2</sup>	LD10 1.00 in <sup>2</sup>
----------------------------	----------------------------	------------------------------

LDS3 .21 in <sup>2</sup>	LDS5 .38 in <sup>2</sup>
-----------------------------	-----------------------------

CD3 .17 in <sup>2</sup>	CD5 .33 in <sup>2</sup>	CD10 .78 in <sup>2</sup>
----------------------------	----------------------------	-----------------------------

**SPEC=40% wirefill**—the recommended design in cable capacity. Leaves room for future moves, adds and changes

**MAX=60% wirefill**—the maximum cable quantity based on cable interweaving and packing factors or UL temp. rise test (electrical)

FILL CAPACITIES

#### Fill Capacity Table for: Coax Cables

Raceway Type	Coax Cables									
	RG6/u		RG11/u		RG58/u		RG59/u		RG62A/u	
	DIA.=0.270		DIA.=0.405		DIA.=0.193		DIA.=0.242		DIA.=0.242	
	FILL		FILL		FILL		FILL		FILL	
	SPEC	MAX	SPEC	MAX	SPEC	MAX	SPEC	MAX	SPEC	MAX
LD3	1	2	—	—	2	4	1	2	2	3
LD5	2	3	1	1	5	7	3	4	3	5
LD10	6	10	3	4	13	20	8	13	9	13
LDP3	1	2	—	—	2	4	1	2	2	3
LDP5	3	4	1	1	5	7	3	4	3	5
LDP10*	6	10	3	4	13	20	8	12	9	13
LD2P10-Left Channel	3	4	1	1	5	8	3	5	4	6
LD2P10-Rgt. Channel	3	5	1	2	6	10	4	6	4	7
LDS3	1	2	—	—	2	4	1	2	2	3
LDS5	2	3	1	1	5	7	3	4	3	5
CD3	1	1	—	—	2	3	1	2	2	3
CD5	2	3	1	1	4	6	2	4	4	5
CD10	5	8	2	3	10	15	6	10	9	13

NOTE: See [page xiv-xv](#) for further explanation of wirefill data.

#### Fill Capacity Table for: Fiber Optic Cable (62.5/125mm) Signal Cables

Raceway Type	Fiber Optic Cables (62.5/125mm)						Signal Cables							
	2 Strand		4 Strand		6 Strand		18AWG		20 AWG		22 AWG		24 AWG	
	DIA.=0.175		DIA.=0.175		DIA.=0.210		DIA.=0.066		DIA.=0.057		DIA.=0.050		DIA.=0.044	
	FILL		FILL		FILL		FILL		FILL		FILL		FILL	
	SPEC	MAX	SPEC	MAX	SPEC	MAX	SPEC	MAX	SPEC	MAX	SPEC	MAX	SPEC	MAX
LD3	3	5	4	5	2	3	24	36	32	49	42	64	55	82
LD5	6	9	6	9	4	6	44	66	59	89	77	116	99	149
LD10	16	24	16	24	11	17	6	175	156	235	203	305	263	394
LDP3	3	5	3	5	2	3	25	37	32	49	42	64	55	82
LDP5	6	9	6	9	4	6	44	67	59	89	77	116	99	149
LDP10	16	24	16	16	11	16	114	171	153	270	199	299	257	386
LD2P10-Left Channel	7	10	7	11	4	7	50	75	67	101	87	131	113	169
LD2P10-Rgt. Channel	8	12	8	12	5	8	58	87	78	117	101	152	131	197
LDS3	3	5	3	5	2	3	24	36	32	49	42	64	55	82
LDS5	6	9	6	9	4	6	44	66	59	89	77	116	99	149
CD3	2	4	4	6	1	2	19	29	26	39	34	51	44	67
CD5	5	8	7	10	3	5	38	57	51	77	67	100	86	130
CD10	12	19	17	25	9	13	91	136	122	183	158	238	205	307

NOTE: See [page xiv-xv](#) for further explanation of wirefill data.

## **PAN-WAY™ Type PD Surface Raceways**

### **Type PD for Power or Communications Cabling**

**PAN-WAY** Type PD Surface Raceway provides a complete system for routing and protecting either power or communication cabling.

Type PD Raceway is a two piece, low profile, single channel raceway system.

Type PD Raceway offers exceptional tamper resistance.



#### **Panduit *PAN-WAY* Type PD Raceway provides the following key benefits:**

- UL-5A Listed to 600 V and CSA 22.2 No. 62-93 Listed to 300 V
- Superior tamper resistance, ideal for school and university applications
- Extremely impact resistant
- 2 sizes to meet your application requirements
- Four standard colors available to blend with surrounding decor
- Selection of fittings to speed installation
- Available in 6', 8' and 10' lengths

**Table of Contents**

Page



**PAN-WAY™ Type PD**

Surface Raceway ..... D7  
 ① ② ③ ④ Configurations ..... D4-D5

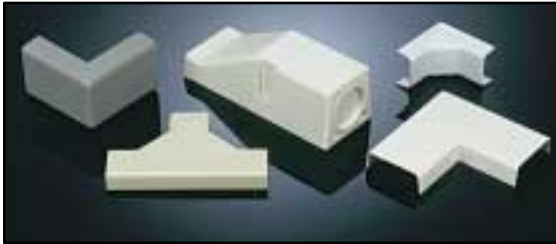

**PAN-WAY Type PD**

Fittings ..... D8

**Fill Capacity Information** ..... D9-D10

**Additional Related Products**



**PAN-WAY** Faceplates ..... A3



**PAN-WAY** Surface Mount Outlet Boxes ..... E3-E5



**PAN-WAY** Accessories ..... H1

**PAN-WAY™ Type PD Raceways—Roadmap**

**Power ONLY Applications**

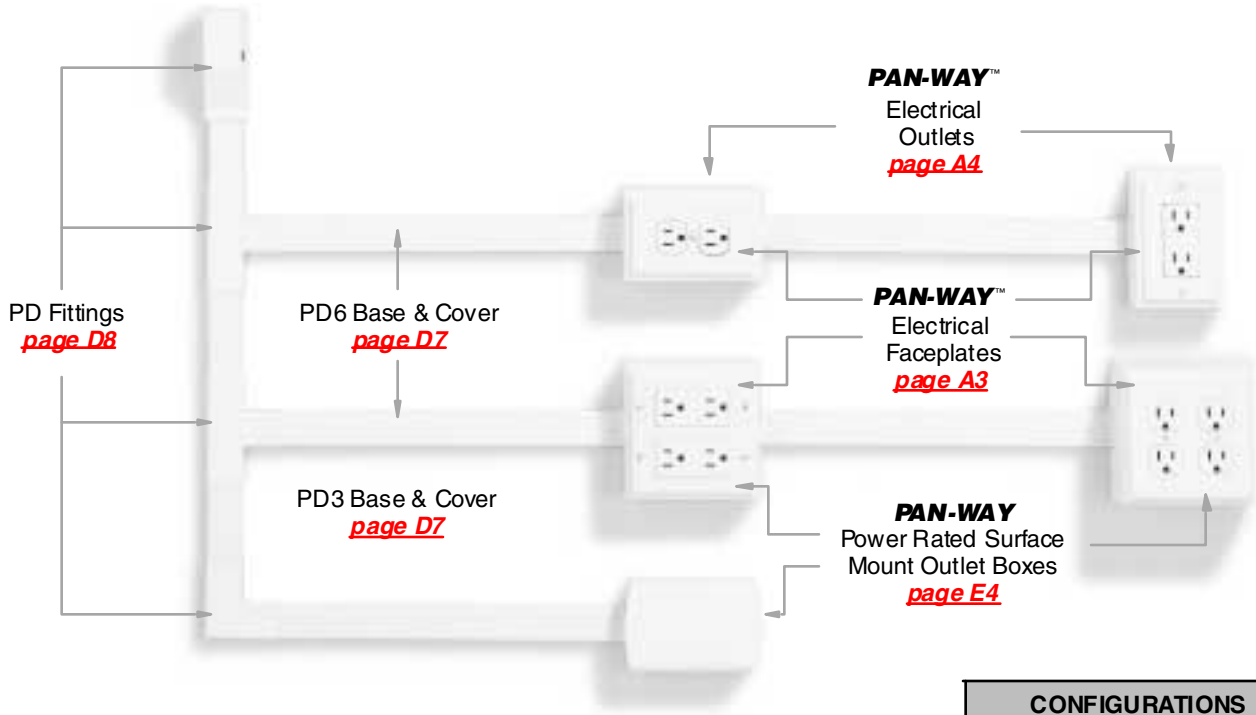

CONFIGURATIONS			
1	2	3	4
See <a href="#">page D4-E5</a>			

**Data ONLY Applications**

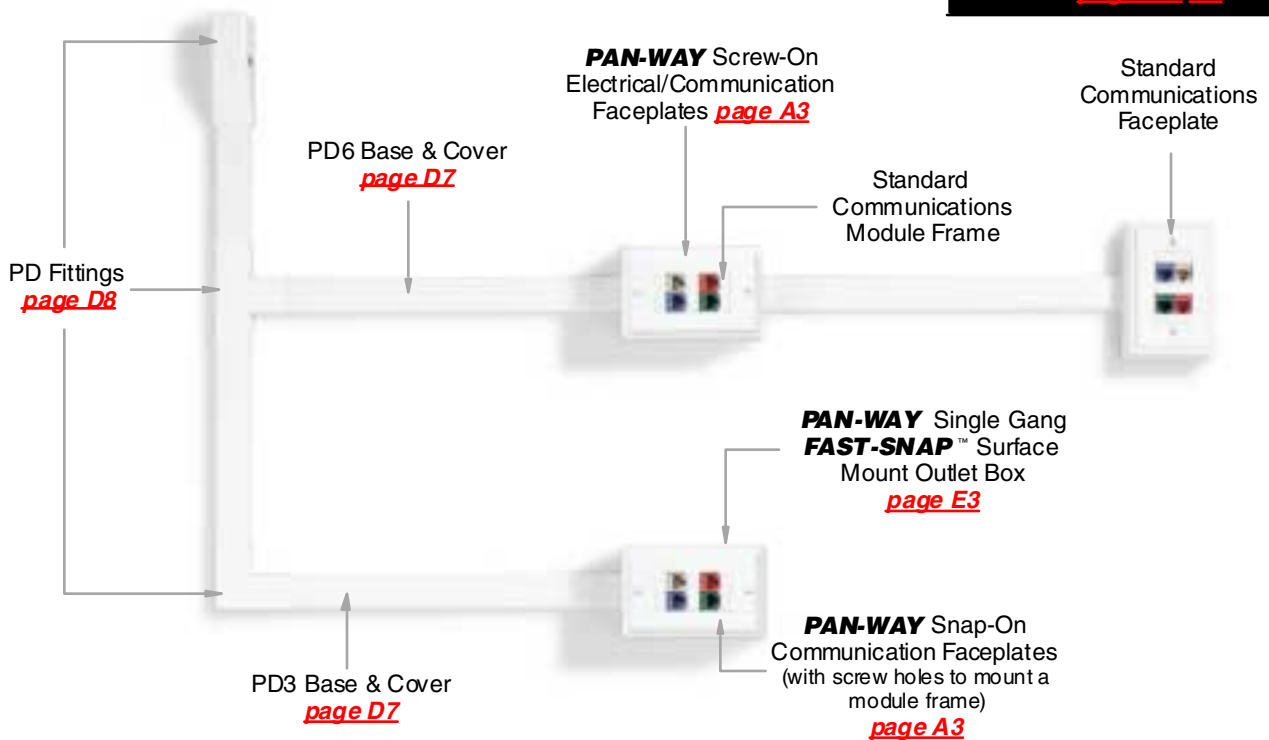

**PAN-WAY™ PD Raceway Configurations**

**Application:** Routing low voltage cables and/or power cabling: Fiber Optic, Category 5, UTP, ScTP, Coax or any other low voltage cable; power cables (up to 600V) in horizontal applications.

PD RACEWAY CONFIGURATIONS

**1 PAN-WAY Snap-On Electrical/Communications Faceplates**

Configurations for this faceplate style not currently available.

**2 PAN-WAY Snap-On Communication Faceplates (with screw holes to mount a module frame)**

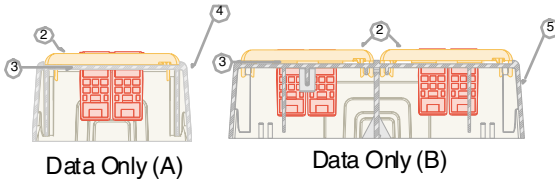

- Snap-On Faceplates provide a superior appearance
- Can use most manufacturers' communication module frames (see chart on page vii)
- **FAST-SNAP™** Boxes snap together for quick installation
- Data and Power box is divided to maintain separation

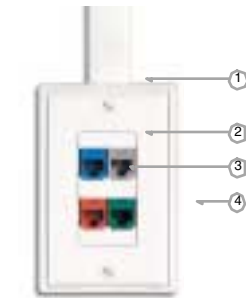

**Data Only (A)**

Components Required	Data (A)	Data (B)	See Page
	X	X	
1. PD3 or PD6 Raceway	X	X	<a href="#">D7</a>
2. Snap-On Electrical/Communication Faceplate(s) (with screw holes to mount a module frame)	X	X	<a href="#">A3</a>
3. Standard Communication Module Frame(s)	X	X	<a href="#">vii</a>
4. Single Gang <b>FAST-SNAP</b> Outlet Box	X		<a href="#">E3</a>
5. Double Gang <b>FAST-SNAP</b> Outlet Box		X	<a href="#">E3</a>
6. Raceway Adapter (BA3 or BA6) to adapt PD to LD10 box breakout	X	X	<a href="#">E5</a>

Note: For data area(s) and fill capacity information see [page D9-D10](#)

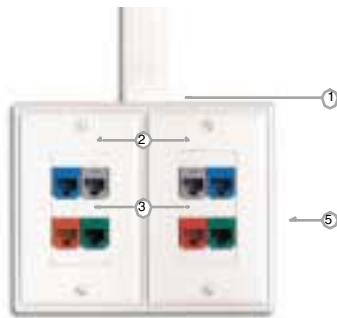

**Data Only (B)**



## PAN-WAY™ PD Raceway Configurations Cont'd

### 3 PAN-WAY U.S. Standard Screw-On Electrical/Communication Faceplates

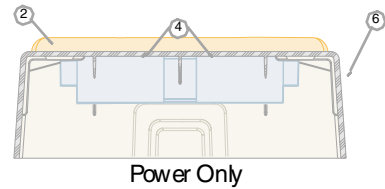
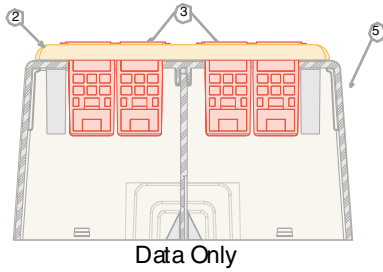

- U.S. Standard Screw-On Electrical Faceplate is used
- Can use most manufacturers' communication module frames (see chart on [page.vii](#))

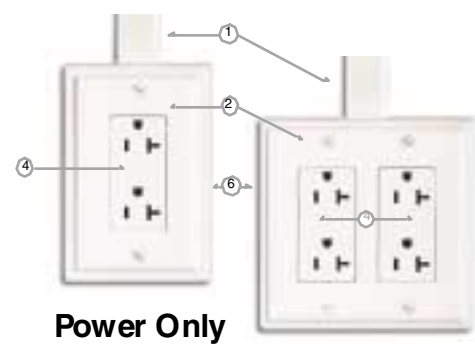
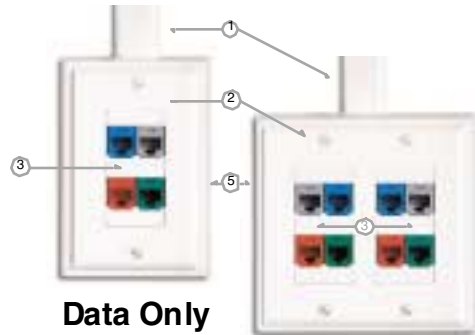

Components Required	Data Only	Power Only	See Page
1. PD3 or PD6 Raceway	X	X	<a href="#">D7</a>
2. U.S. Standard Screw-On Electrical/Communication Faceplate(s) (single or double gang available)	X	X	<a href="#">A3</a>
3. Standard Communication Module Frame(s)	X		<a href="#">vii</a>
4. <b>PAN-WAY</b> Electrical Outlet(s) (ERU20 shown)		X	<a href="#">A4</a>
5. Low Voltage Surface Mount Outlet Boxes (7 styles to choose from)	X		<a href="#">E3</a>
6. Power Rated Surface Mount Outlet Boxes (5 styles to choose from)		X	<a href="#">E4</a>
7. Raceway Adapter (BA3 or BA6) to adapt PD to LD10 box breakout	X	X	<a href="#">E5</a>

Note: For data area(s) and fill capacity information see [page.D9-D10](#)



#### Optional for Power



- 20A Low Profile Surface Mount Outlet Box includes box, 20A outlet and cover in duplex rectangular or 106 styles

Components Required	Power Only	See Page
1. PD3 or PD6 Raceway	X	<a href="#">D7</a>
2. 20A Low Profile Rectangular or 106 Style Surface Mount Outlet Boxes (include box, 20A outlet & self cover)	X	<a href="#">A4</a>
3. Raceway Adapter (BA3 or BA6) to adapt PD to LD10 box breakout	X	<a href="#">E5</a>

### 4 U.S. Standard Screw-On Communication Faceplates

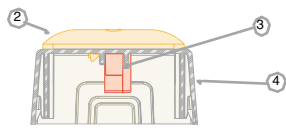
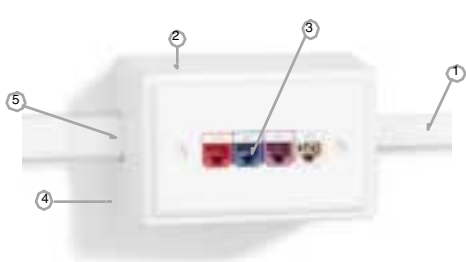

- Uses selected manufacturers' standard communication faceplates
- Panduit® Styles available, for more information refer to [page.xii](#)

Components Required	Data Only	See Page
1. PD3 or PD6 Raceway	X	<a href="#">D7</a>
2. Most Mfg. U.S. Screw-On Standard Communication Faceplates (see page listed for Panduit styles)	X	—
3. Manufacturers' inserts and/or modules	X	—
4. Low Voltage Surface Mount Outlet Box (7 styles to choose from)	X	<a href="#">E3</a>
5. Raceway Adapter (BA3 or BA6) to adapt PD to LD10 box breakout	X	<a href="#">E5</a>

Note: For data area(s) and fill capacity information see [page.D9-D10](#)

**PAN-WAY™ Surface Raceway Applications**



**PAN-WAY** Type PD Surface Raceway is ideal for power or low voltage cabling applications. It can be used anywhere power or low voltage cabling is required including offices, factories, schools, universities, etc.



NEMA Standard Faceplates can be mounted to surface mount outlet boxes for use with Type PD Raceway in network cabling applications.



The "Flexible" fitting can be used to route Type PD Raceway installation around or over obstacles. (See [page D8](#))



Type PD Raceway can be connected directly to conduit with the "Entrance End" fitting. (See [page D8](#))

## PAN-WAY™ Type PD Surface Raceway

**PAN-WAY** Type PD Surface Raceway is a single channel raceway system to route, protect and conceal power, data, voice, or video cabling.

### PD System Benefits:

- **UL-5A Listed** to 600 V and CSA 22.2 No. 62-93 Listed to 300 V
- **Extremely tamper resistant** for School & University applications
- **NEW! Now FT-4 Rated** for Canada



### Type PD Raceway Bases and Covers

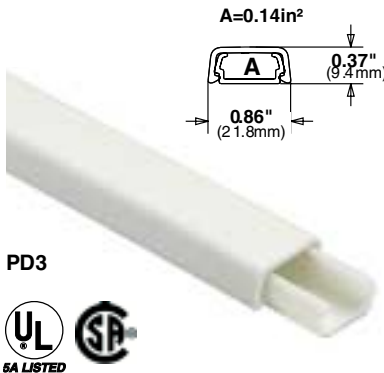

PD3



PD6



6 ft. Part Number	Std. Ctn. Qty.	8 ft. Part Number	Std. Ctn. Qty.	10 ft. Part Number	Std. Ctn. Qty.	Color <sup>u</sup>
-------------------	----------------	-------------------	----------------	--------------------	----------------	--------------------

### Type PD3 Raceway Base and Cover

6 ft. lengths		8 ft. lengths		10 ft. lengths		
PD3IW6	120 ft.	PD3IW8	160 ft.	PD3IW10	200 ft.	Off White
Raceway Base and Cover packaged together. Raceway Base without adhesive backing. Cover Dimensions: .86(21.8mm)x.37(9.4mm)						

### Type PD3 Raceway Base and Cover - Adhesive Backed

6 ft. lengths		8 ft. lengths		10 ft. lengths		
PD3IW6-A	120 ft.	PD3IW8-A	160 ft.	PD3IW10-A	200 ft.	Off White
Raceway Base and Cover packaged together. Raceway Base with pre-applied adhesive backing to speed installation.						

### Type PD6 Raceway Base and Cover

6 ft. lengths		8 ft. lengths		10 ft. lengths		
PD6IW6	120 ft.	PD6IW8	160 ft.	PD6IW10	200 ft.	Off White
Raceway Base and Cover packaged together. Raceway Base without adhesive backing. Cover Dimensions: 1.33(33.8mm)x.46(11.6mm)						

### Type PD6 Raceway Base and Cover - Adhesive Backed

6 ft. lengths		8 ft. lengths		10 ft. lengths		
PD6IW6-A	120 ft.	PD6IW8-A	160 ft.	PD6IW10-A	200 ft.	Off White
Raceway Base and Cover packaged together. Raceway Base with pre-applied adhesive backing to speed installation.						

<sup>u</sup> All parts listed in Off White (W) color. To order Electrical Ivory substitute EI for IW in above part numbers. Contact factory for details.

#### ORDERING INFORMATION:

Order number of feet required, in multiples of Standard Length Increment.

**NOTE: Type PD Raceway Base requires screw mounting if it is being used for power cabling applications.**

**UL** **SA LISTED** **PAN-WAY Type PD Raceway Fittings**

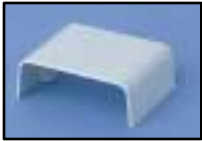

**Coupler Fitting**



**Inside Corner Fitting**



**Right Angle Fitting**



**Entrance End Fitting**

Breakout for 1/2" conduit



**Outside Corner Fitting**

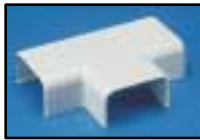

**Tee Fitting**



**Flexible Fittings**



**Flexible Fittings**



**End Cap Fitting**



**Wire Retainer**  
For use with PD6 Raceway

Part Number	Description	Color <sup>u</sup>	Std. Pkg. Qty.	Std. Ctn. Qty.
PCF3IW-X	Type PD3 – Coupler Fitting	Off White	10 pcs.	100 pcs.
PCF6IW-X	Type PD6 – Coupler Fitting	Off White	10 pcs.	100 pcs.
PICF3IW-X	Type PD3 – Inside Corner Fitting	Off White	10 pcs.	100 pcs.
PICF6IW-X	Type PD6 – Inside Corner Fitting	Off White	10 pcs.	100 pcs.
PRAF3IW-X	Type PD3 – Right Angle Fitting	Off White	10 pcs.	100 pcs.
PRAF6IW-X	Type PD6 – Right Angle Fitting	Off White	10 pcs.	100 pcs.
PEEF36IW-X	Type PD3 and PD6 – Entrance End Fitting	Off White	10 pcs.	100 pcs.
POCF3IW-X	Type PD3 – Outside Corner Fitting	Off White	10 pcs.	100 pcs.
POCF6IW-X	Type PD6 – Outside Corner Fitting	Off White	10 pcs.	100 pcs.
PTF3IW-X	Type PD3 – Tee Fitting	Off White	10 pcs.	100 pcs.
PTF6IW-X	Type PD6 – Tee Fitting	Off White	10 pcs.	100 pcs.
PFF36EI18	Type PD3 and PD6 – Flexible Fitting for "Raceway to Raceway"	Elec. Ivory	1 pc.	10 pcs.
PFBC36EI18	Type PD3 and PD6 – Flexible Fitting for "Raceway to Conduit Junction Box"	Elec. Ivory	1 pc.	10 pcs.
PECF3IW-X	Type PD3 – End Cap Fitting	Off White	10 pcs.	100 pcs.
PECF6IW-X	Type PD6 – End Cap Fitting	Off White	10 pcs.	100 pcs.
PWR6-X	PD6 Wire Retainer	Natural	10 pcs.	100 pcs.

<sup>u</sup> All parts listed in Off White (IW) color. To order other colors substitute EI (Electric Ivory), IG (Light Gray), and WH (White). Contact factory for details.

**ORDERING INFORMATION:**

Order number of pieces required, in multiples of Standard Package.

## Fill Capacities for Type PD Raceway

This information is to be used as a guide in selecting the proper size raceway. The maximum amounts may vary according to the wire installation methods, straightness of wires, etc.

**SPEC=40% wirefill**—the recommended design in cable capacity. Leaves room for future moves, adds and changes

**MAX=60% wirefill**—the maximum cable quantity based on cable interweaving and packing factors or UL temperature rise test for electrical

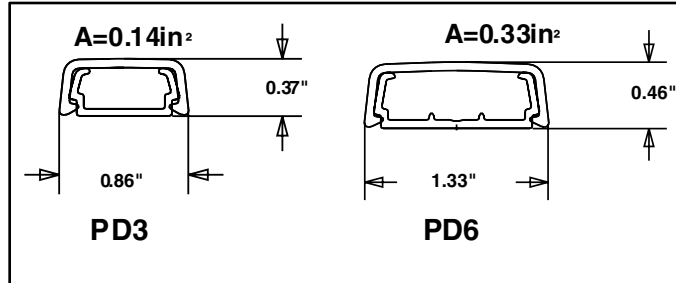

TYPE PD FILL CAPACITIES

### Fill Capacity Table for:

- Electrical
- Voice Grade 24 AWG UTP
- Data Grade 24 AWG UTP

Raceway Channel Configurations	Electrical Cables			Voice Grade Cables						Data Grade Cables			
	AWG			24 AWG UTP CM/CMR						24 AWG UTP CM			
	14	12	10	2 pr		3 pr		4 pr		25 pr		Cat. 5 4 pr	
	THHN/T90			DIA.= 0.120		DIA.= 0.150		DIA.= 0.190		DIA.=0.422		DIA.=0.217	
	0.105	0.122	0.153	FILL		FILL		FILL		FILL		FILL	
	MAX	MAX	MAX	SPEC	MAX	SPEC	MAX	SPEC	MAX	SPEC	MAX	SPEC	MAX
PD3	5	4	—	5	7	3	5	2	3	—	—	2	2
PD6	10	7	5	12	18	7	11	5	7	—	—	4	5
PD6 with retainer	10	7	5	7	11	5	7	3	4	—	—	2	3

NOTE: See [page xiv-xv](#) for further explanation of the wirefill data.

### Fill Capacity Table for:

- Data Grade 22 AWG UTP
- Data Grade 24, 22 AWG STP
- Type 1A STP

Raceway Channel Configurations	Data Grade Cables													
	24 AWG STP CM				22 AWG UTP CM				22 AWG STP CM				1A 22 AWG STP CM	
	25 pr		4 pr		25 pr		4 pr		25 pr		4 pr		—	
	DIA.=0.512		DIA.=0.250		DIA.= 0.544		DIA.= 0.234		DIA.=0.635		DIA.=0.286		DIA.=0.430	
	FILL		FILL		FILL		FILL		FILL		FILL		FILL	
	SPEC	MAX	SPEC	MAX	SPEC	MAX	SPEC	MAX	SPEC	MAX	SPEC	MAX	SPEC	MAX
PD3	—	—	1	2	—	—	1	2	—	—	—	—	—	—
PD6	—	—	3	4	—	—	3	5	—	—	2	3	—	—
PD6 with retainer	—	—	—	—	—	—	—	—	—	—	—	—	—	—

NOTE: See [page xiv-xv](#) for further explanation of the wirefill data.

**Fill Capacities for Type PD Raceway**

This information is to be used as a guide in selecting the proper size raceway. The maximum amounts may vary according to the wire installation methods, straightness of wires, etc.

**SPEC=40% wirefill**—the recommended design in cable capacity. Leaves room for future moves, adds and changes

**MAX=60% wirefill**—the maximum cable quantity based on cable interweaving and packing factors or UL temperature rise test for electrical

TYPE PD FILL CAPACITIES

**Fill Capacity Table for:  
•Coax Cables**

Raceway Channel Configurations	Coax Cables									
	RG 6/u		RG 11/u		RG58/u		RG 59/u		RG62A/u	
	DIA.=0.270		DIA.=0.405		DIA.=0.193		DIA.=0.242		DIA.=0.242	
	FILL		FILL		FILL		FILL		FILL	
	SPEC	MAX	SPEC	MAX	SPEC	MAX	SPEC	MAX	SPEC	MAX
PD3	—	—	—	—	2	3	1	2	1	2
PD6	2	3	—	—	5	7	3	4	3	4
PD6 with retainer	—	—	—	—	3	4	—	—	—	—

NOTE: See [page xiv-xv](#) for further explanation of the wirefill data.

**Fill Capacity Table for:  
•Fiber Optic Cable (62.5/125mm) •Signal Cables**

Raceway Channel Configurations	Fiber Optic Cables (62.5/125mm)						Signal Cables							
	2 Strand		4 Strand		6 Strand		18AWG		20 AWG		22 AWG		24 AWG	
	DIA.=0.175		DIA.=0.175		DIA.=0.210		DIA.=0.066		DIA.=0.057		DIA.=0.050		DIA.=0.044	
	FILL		FILL		FILL		FILL		FILL		FILL		FILL	
	SPEC	MAX	SPEC	MAX	SPEC	MAX	SPEC	MAX	SPEC	MAX	SPEC	MAX	SPEC	MAX
PD3	2	3	2	3	2	2	16	25	22	33	29	43	37	55
PD6	5	8	5	8	4	6	39	58	52	78	67	101	87	130
PD6 with retainer	3	5	3	5	2	4	25	37	33	49	43	64	55	83

NOTE: See [page xiv-xv](#) for further explanation of the wirefill data.

**Raceway Cutting Instructions:**

•For Type PD Raceway, use Panduit Cutting Tool, Part No. SRT found on [page H1](#).

*Alternative method:* For small quantities, use a fine tooth handsaw. For larger quantities, a fine tooth saw (10" dia., high speed steel, 1/16" thick, hollow ground to 2" collar diameter, 300 tooth, alternate top bevel, 14", no set blade) will produce good results.

## **PAN-WAY™** Surface Mount Outlet Boxes

**PAN-WAY** Surface Mount Outlet Boxes are available to mount, conceal and terminate power and communication cables with **PAN-WAY** Plastic Surface Raceway.

All are available in colors to match or complement the raceway.



### Surface Mount Outlet Boxes

- One-gang and two-gang styles for fiber optic, low voltage and power applications
- New **FAST-SNAP™** boxes and faceplates provide screwless installations
- Provide access to length of cable to facilitate termination
- Compatible with LD Profile or PD Raceways
- Power rated boxes UL 5A Listed to 600V and CSA Certified to 300V
- Select styles available in 6 colors
- **FAST-SNAP** boxes available in 4 colors

**Table of Contents**

Page



**PAN-WAY™ FAST-SNAP™ Surface Mount Outlet Boxes**

For Power and Communications Cabling . . . . . E3



**PAN-WAY Low Voltage Surface Mount Outlet Boxes**

For Communications Cabling . . . . . E3

**PAN-WAY Power Rated Surface Mount Outlet Boxes**

For Power or Communications Cabling. . . . . E4



**PAN-WAY Divided Surface Mount Outlet Boxes**

For Power & Communications Cabling . . . . . E5

Raceway Adapters . . . . . E5

Selection Chart . . . . . E6



## PAN-WAY™ FAST-SNAP™ Surface Mount Outlet Boxes



**NEW! Communication Only!**



JB1FS\*\*-A

Accept  
**Snap-On**  
Faceplates!

Part Number	Description	Color	Std. Pkg. Qty.	Std. Ctn. Qty.
-------------	-------------	-------	----------------	----------------

### Single Gang FAST-SNAP Low Voltage Surface Mount Outlet Box

JB1FSIW-A	Single gang snap-together cover and base with adhesive backing. Accepts <b>PAN-WAY</b> Snap-On Faceplates for data applications. L=5.00" W=3.26" H=1.62" Conduit breakouts: 1", 3/4", 1/2" For use with single channel raceways.	Off White	1 pc.	10 pcs.
-----------	-------------------------------------------------------------------------------------------------------------------------------------------------------------------------------------------------------------------------------------------	-----------	-------	---------



**NEW! Power & Communication!**



JB2FS

Accept  
**Snap-On**  
Faceplates!



### Double Gang FAST-SNAP Power Rated Surface Mount Outlet Box

JBP2FSIW	Double gang snap-together cover and base. Accepts <b>PAN-WAY</b> Snap-On Faceplates for power and data applications. L=5.00" W=6.14" H=1.62" Conduit breakouts: 1", 3/4", 1/2" For use with multi-channel raceways.	Off White	1 pc.	10 pcs.
----------	------------------------------------------------------------------------------------------------------------------------------------------------------------------------------------------------------------------------------	-----------	-------	---------

◆ All parts listed in Off White (IW) color. To order other colors substitute EI (Electric Ivory), IG (Light Gray), and WH (White). Contact factory for details.

**ORDERING INFORMATION:**

Order number of pieces required, in multiples of Standard Package.

## PAN-WAY Low Voltage Surface Mount Outlet Boxes



**NEW!**



JBX35 10\*\*-A

New  
Improved  
Design!

Part Number	Description	Color	Std. Pkg. Qty.	Std. Ctn. Qty.
-------------	-------------	-------	----------------	----------------

### Single Gang Two-Piece Snap-Together Box

JBX3510IW-A	Two-Piece box with adhesive backing. L=5.02" W=3.27" H=1.62" Conduit breakouts: 1", 3/4", 1/2"	Off White	1 pc.	10 pcs.
-------------	------------------------------------------------------------------------------------------------------	-----------	-------	---------

### Single Gang One-Piece Box

JB1IW-A	One-Piece Box with adhesive backing. L=5.09" W=3.34" H=1.75" Conduit breakouts: 1", 3/4", 1/2"	Off White	1 pc.	10 pcs.
---------	------------------------------------------------------------------------------------------------------	-----------	-------	---------

### Single Gang One-Piece Deep Box

JB1DIW-A	One Piece Deep Box with adhesive backing. L=5.23" W=3.48" H=2.75" Conduit breakouts: 1", 3/4", 1/2"	Off White	1 pc.	10 pcs.
----------	-----------------------------------------------------------------------------------------------------------	-----------	-------	---------

### Double Gang Two-Piece Box

JBP2IW	Double Gang Box base & cover (screws included). L=5.05" W=5.05" H=1.62" Conduit breakouts: 3/4", 1/2"	Off White	1 pc.	10 pcs.
--------	-------------------------------------------------------------------------------------------------------------	-----------	-------	---------

### Double Gang Two-Piece Deep Box

JBP2DIW	Double Gang Deep Box base, cover and divider wall (screws included). L=5.14" W=5.18" H=2.75" Conduit breakouts: 1", 3/4", 1/2"	Off White	1 pc.	10 pcs.
---------	--------------------------------------------------------------------------------------------------------------------------------------	-----------	-------	---------

### Round Two-Piece Box

RJBX35 10IW	Round Box base & cover (screws not included). DIA: 5.25" H=1.05" Conduit breakouts: 1", 3/4"	Off White	1 pc.	10 pcs.
-------------	----------------------------------------------------------------------------------------------------	-----------	-------	---------

### Round Box Adapter

JBA-X	Adapts single gang surface mount outlet boxes to in-wall conduit boxes.		1 pc.	10 pcs.
-------	-------------------------------------------------------------------------	--	-------	---------

◆ All parts listed in Off White (IW) color. To order other colors substitute EI (Electric Ivory), IG (Light Gray), WH (White), BR (Brown) and BL (Black). Contact factory for details for availability of specific styles and colors

**ORDERING INFORMATION:**

Order number of pieces required, in multiples of Standard Package.

NOTE: See Selection Chart on page E6 for detailed information on specific usage with raceways.



**NEW!**



JBP2



**NEW!**



JBP2D



RJBX35 10



JBA-X

**PAN-WAY™ Power Rated Surface Mount Outlet Boxes**



**Low Profile Box**

JBP1E



JBP1



JBP11



JBP1D



JBP2



JBP2D



PSJBX



PRJBX36



Part Number	Description	Color◆	Std. Pkg. Qty.	Std. Ctn. Qty.
<b>Power Rated Single Gang Two-Piece Low Profile Box</b>				
JBP1EIW	Single Gang Low Profile Box—base and cover. L= 4.99" W=3.30" H=1.00" Conduit breakouts: ½", ¾", 1"	Off White	1 pc.	10 pcs.
<b>Power Rated Single Gang Two-Piece Box</b>				
JBP1IW	Single Gang Box—base and cover. L= 5.19" W=3.45" H=1.75" Conduit breakouts: ½", ¾", 1"	Off White	1 pc.	10 pcs.
<b>Power Rated Single Gang Two-Piece Intermediate Box</b>				
JBP1IIW	Single Gang Intermediate Box—base and cover. L= 5.12" W=3.38" H=2.27" Conduit breakouts: ½", ¾"	Off White	1 pc.	10 pcs.
<b>Power Rated Single Gang Two-Piece Deep Box</b>				
JBP1DIW	Single Gang Deep Box—base and cover. L= 5.19" W=3.26" H=2.75" Conduit breakouts: ½", ¾", 1"	Off White	1 pc.	10 pcs.
<b>Power Rated Double Gang Two-Piece Box</b>				
JBP2IW	Double Gang Box—base & cover (screws included). L= 5.05" W=5.05" H=1.62" Conduit breakouts: ½", ¾"	Off White	1 pc.	10 pcs.
<b>Power Rated Double Gang Two-Piece Deep Box</b>				
JBP2DIW	Double Gang Deep Box—base, cover and divider wall (screws included). L= 5.19" W=5.19" H=2.75" Conduit breakouts: ½", ¾", 1"	Off White	1 pc.	10 pcs.
<b>Power Rated Two-Piece Power Source Box</b>				
PSJBXIW	Power Source Box—base & cover (screws not included). L= 5.02" W=3.27" H=1.31" Conduit breakouts: ½", ¾", 1"	Off White	1 pc.	10 pcs.
<b>Power Rated Two-Piece Round Box</b>				
PRJBX36IW	Round Outlet Box—base & cover (screws not included). Dia: 5.25" H=1.05" Conduit breakouts: ¾", 1"	Off White	1 pc.	10 pcs.

◆ All parts listed in Off White (IW) color. To order other colors substitute EI (Electric Ivory), IG (Light Gray), WH (White), BR (Brown) and BL (Black). Contact factory for details for availability of specific styles and colors.

**ORDERING INFORMATION:**

Order number of pieces required, in multiples of Standard Package.

**NOTE:** See Selection Chart on [page E6](#) for detailed information on specific usage with raceways.

**PAN-WAY™ Divided Surface Mount Outlet Boxes**



Part Number	Description	Color◆	Std. Pkg. Qty.	Std. Ctn. Qty.
<b>Power Rated Single Gang Two-Piece Deep Box</b>				
JBP1DIW	Single Gang Deep Box—base and cover. L=5.19" W=3.26" H=2.75" Conduit breakouts: ½", ¾", 1"	Off White	1 pc.	10 pcs.
<b>Single Gang Pass Through Divider for LD2P10 Raceway</b>				
JBD1	Pass through divider allows power & communications outlets to be routed in series. Used with JBP1D box. Must use with LD2P10 Raceway.	—	1 pc.	10 pcs.
<b>Power Rated Double Gang Three-Piece Divided Box</b>				
JBP2SIW	Double Gang Box—base, cover and divider wall for power and data applications (screws included). L=5.05" W=5.05" H=1.62" Conduit breakouts: ½", ¾"	Off White	1 pc.	10 pcs.
<b>Power Rated Double Gang Two-Piece Deep Box</b>				
JBP2DIW	Double Gang Deep Box—base, cover and divider wall (screws included) L=5.19" W=5.19" H=2.75" Conduit breakouts: ½", ¾", 1"	Off White	1 pc.	10 pcs.
<b>Double Gang Pass Through and Divider for LD2P10 Raceway</b>				
JBD2	Pass through divider allows power & communications outlets to be routed in series. Used with JBP2D box. Must use with LD2P10 Raceway.	—	1 pc.	10 pcs.

◆ All parts listed in Off White (IW) color. To order other colors substitute EI (Electric Ivory), IG (Light Gray), WH (White), BR (Brown) and BL (Black). Contact factory for details for availability of specific styles and colors.

**ORDERING INFORMATION:**

Order number of pieces required, in multiples of Standard Package.

**NOTE:** See Selection Chart on [page E6](#) for detailed information on specific usage with raceways.

**Raceway Adapters**



Part Number	Description	Color◆	Std. Pkg. Qty.	Std. Ctn. Qty.
<b>Raceway Adapters for LD Profile Raceways</b>				
CA3IW-X	Fits into universal breakout of DCEFX or RAEFX fittings. For use with Types LDP3, LD3, and LDS3 raceways.	Off White	10 pcs.	100 pcs.
CA5IW-X	Fits into universal breakout of DCEFX or RAEFX fittings. For use with Types LDP5, LD5, and LDS5 raceways.	Off White	10 pcs.	100 pcs.
<b>Raceway Adapters for PD Raceways</b>				
BA3IW-X	Fits into LD10 breakout of most <b>PAN-WAY</b> Surface Mount Outlet Boxes. For use with Type PD3 raceway.	Off White	10 pcs.	100 pcs.
BA6IW-X	Fits into LD10 breakout of most <b>PAN-WAY</b> Surface Mount Outlet Boxes. For use with Type PD3 raceway.	Off White	10 pcs.	100 pcs.

◆ All parts listed in Off White (IW) color. To order other colors substitute EI (Electric Ivory), IG (Light Gray), WH (White), and BR (Brown). BL (Black) is also available in select Size 5 Fittings ONLY. Contact factory for details.

**ORDERING INFORMATION:**

Order number of pieces required, in multiples of Standard Package.

**NOTE:** See Selection Chart on [page E6](#) for detailed information on specific usage with raceways.

# Selection Chart for using **PAN-WAY™** Plastic Surface Raceways with **PAN-WAY** Surface Mount Outlet Boxes

**How to use this chart:**

- 1) Locate the desired **PAN-WAY** Raceway in the left column.
- 2) Locate the desired box in the top row.
- 3) Locate the intersecting space to see if they can be used together.
- 4) Color indicates proper box breakout (or adapter for PD raceway.)

PAN-WAY Outlet Boxes										PAN-WAY Fittings
Low Voltage ONLY		Power or Low Voltage								
JB1, JB1D, JB1FS, JBX3510	RJBX3510	JBP1	JBP1D	JBP1E	JBP1I, JBP2	JBP2S, JBP2D, JBP2FS	PRJBX36	PSJBX		T3TRANS, RAEFX, DCEFX

SELECTION CHART

Type LD (Low Voltage ONLY)										
LD3	Y	Y	Y	Y	N	Y	Y	N	Y	Y w/CA3
LD5	Y	Y	Y	Y	N	Y	Y	N	Y	Y w/CA5
LD10	Y	Y	Y	Y	N	Y	Y	N	Y	Y
Type LDP (Power or Low Voltage)										
LDP3	Y	Y	Y	Y	Y	Y	Y	N	Y	Y w/CA3
LDP5	Y	Y	Y	Y	Y	Y	Y	N	Y	Y w/CA5
LDP10	Y	Y	Y	Y	Y	Y	Y	N	Y	Y
Type LDS (Power or Low Voltage)										
LDS3	Y	Y	Y	Y	Y	Y	Y	N	Y	Y w/CA3
LDS5	Y	Y	Y	Y	Y	Y	Y	N	Y	Y w/CA5
Type LD2P10 (Power and Low Voltage)										
LD2P10	N	N	N	Y w/JBD1	N	N	Y	N	N	N
Type CD (Low Voltage ONLY)										
CD3	Y	Y	Y	Y	N	Y	Y	N	Y	Y w/CA3
CD5	Y	Y	Y	Y	N	Y	Y	N	Y	Y w/CA5
CD10	Y	Y	Y	Y	N	Y	Y	N	Y	Y
Type PD (Power or Low Voltage)										
PD3	Y w/BA3	N	Y w/BA3	Y w/BA3	Y w/BA3	Y w/BA3	Y w/BA3	Y	N	N
PD6	Y w/BA6	N	Y w/BA6	Y w/BA6	Y w/BA6	Y w/BA6	Y w/BA6	Y	N	N
Type T3 Transition Fitting (Power or Low Voltage)										
T3 Transition Fitting	Y	N	Y	Y	Y	Y	Y	N	Y	N

**Breakout Schemes**

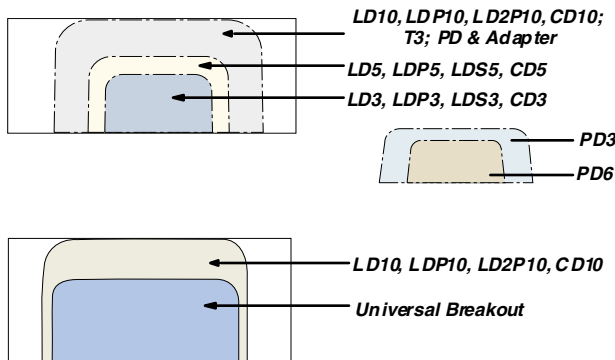

**Adapters**

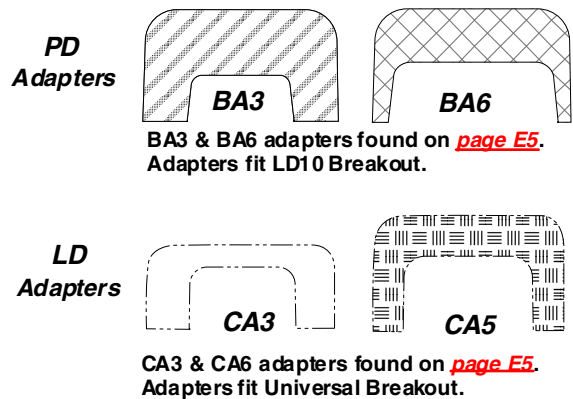

 **NEW!** **PAN-WAY™ TE-70 Non-Metallic Surface Raceway**  
for Power and Communications Cabling

**PAN-WAY** TE-70 Surface Raceway provides a complete system for routing, protecting and terminating both your communications and power cabling systems.

The multi-channel design keeps electrical and communication cables separated. This gives you the

flexibility to install power cables first, then easily add communication cables later.

Type TE-70 Raceway is tamper-resistant while also allowing you access for moves, adds and changes.



**Panduit PAN-WAY TE-70 Raceway provides the following key benefits:**

- Large Capacity for power and communication applications
- Power Rated to 600V (UL) **meets new UL5A standards**, 300V (CSA) meets CSA 22.2 No. 62-93 standards
- Covers and fittings are extremely tamper resistant
- **New!** Snap-On Electrical/Communication Faceplates require less hardware for quick terminations and lower installed cost
- Four standard colors available to complement any surrounding decor

**Table of Contents**



	Page
<b>PAN-WAY™ TE-70</b>	
1 2 3 4 Configurations .....	F4-F5
Raceway Base & Cover .....	F6
Fill Capacities .....	F8-F10



<b>PAN-WAY TE-70</b>	
Fittings .....	F6



<b>PAN-WAY TE-70</b>	
Accessories .....	F7



<b>PAN-WAY Snap-On Faceplates</b>	
Electrical/Communication Faceplates .....	A3
Electrical/Communication Faceplates (with screw holes to mount a module frame) .....	A3

**PAN-WAY™ TE-70 Non-Metallic Raceway—Roadmap**

**TE-70 System**

T-70 CONFIGURATIONS			
1	2	3	4
See <a href="#">page F4</a> - <a href="#">F5</a>			

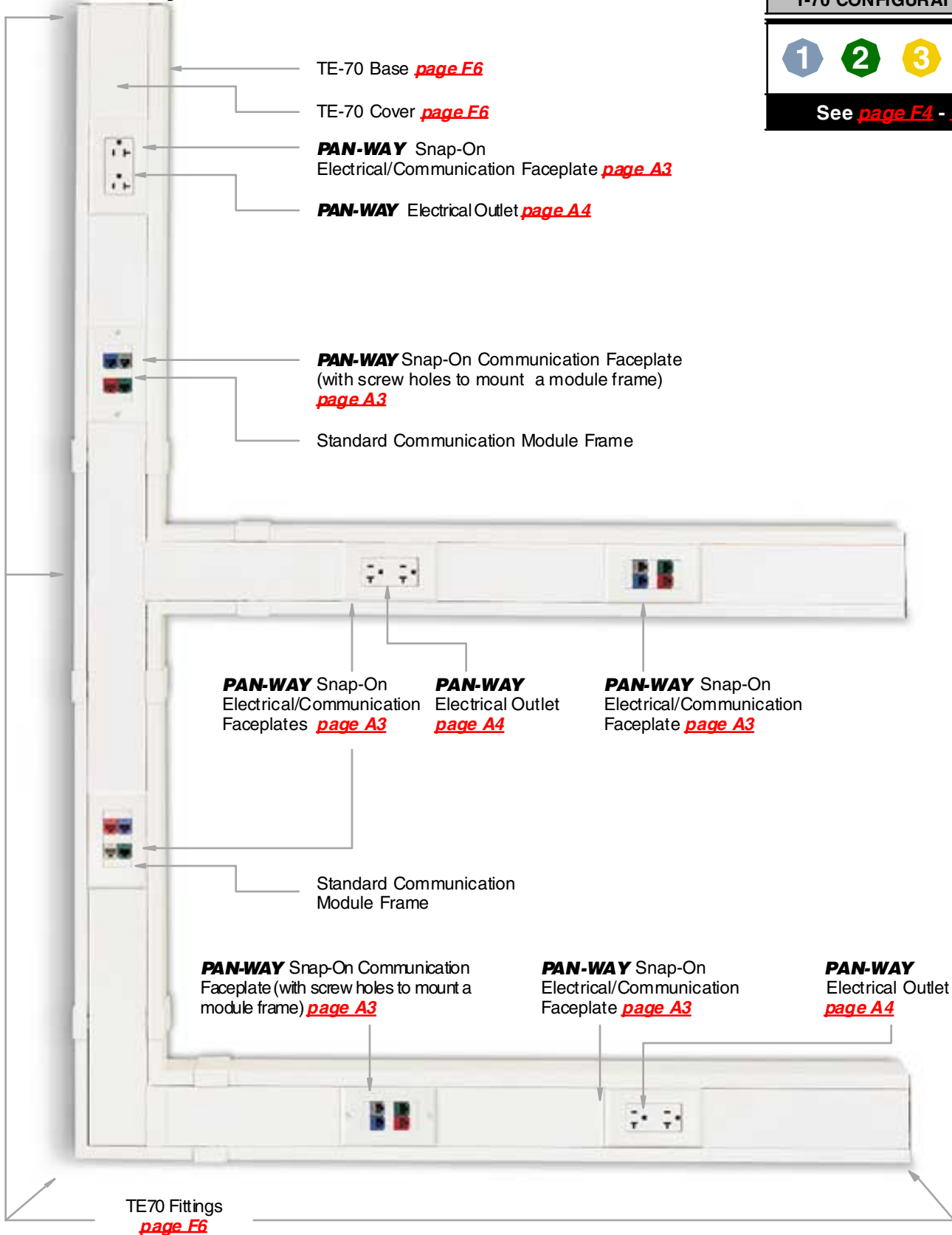

**PAN-WAY™ TE-70 Raceway Configurations**

**Application:** Routing low voltage cables and/or power cabling: Fiber Optic, Category 5, UTP, ScTP, Coax or any other low voltage cable; power cables (up to 600V) in horizontal applications.

**TE-70**

Base: [page F6](#)  
 Cover: [page F6](#)  
 Fittings: [page F6](#)

TE-70 CONFIGURATIONS

**1 PAN-WAY Snap-On Electrical/Communications Faceplates**

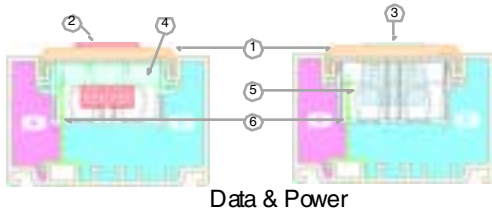

Data & Power

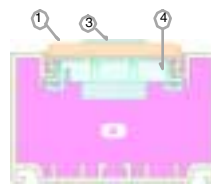

Power Only

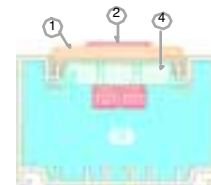

Data Only

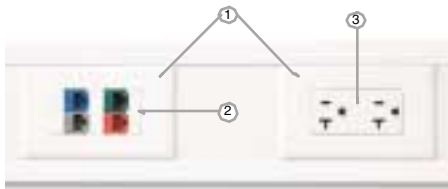

- Snap-On Faceplates provide a superior appearance
- Can use most manufacturers' communication module frames (see chart on [page vii](#))

Areas (in <sup>2</sup> )	A	B
Data & Power	1.65	3.66
Data Only	—	6.80
Power Only	7.20	—

Components Required	Data Only	Power Only	Data & Power	See Page
1. Snap-On Electrical/Comm. Faceplate(s) (T70PG shown)	X	X	X	<a href="#">A3</a>
2. Standard Communication Module Frame	X		X	<a href="#">vii</a>
3. <b>PAN-WAY</b> Electrical Outlet (ERU20)		X	X	<a href="#">A4</a>
4. Device Mounting Bracket (T70DB-X shown)	X	X	X	<a href="#">FZ</a>
5. Hanging Box (TE70HB shown)			X	<a href="#">FZ</a>
6. Divider Wall (TE70DW shown)			X	<a href="#">F6</a>

**2 PAN-WAY Snap-On Communication Faceplates (with screw holes for module frames)**



Areas (in <sup>2</sup> )	A	B
Data Only	—	7.33

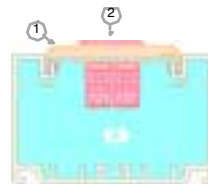

Data Only

- Faceplate requires no mounting bracket or hanging box
- Can use most manufacturers' communication module frames (see chart on [page vii](#))

Components Required	Data Only	See Page
1. Snap-On Communication Faceplate (with screw holes for mounting module frame) (T70PGS shown)	X	<a href="#">A3</a>
2. Standard Communications Module Frame	X	<a href="#">vii</a>

Note: For power and data applications use with configuration #1 above or with configuration #3 shown on next page



## PAN-WAY™ TE-70 Raceway Configurations Cont'd

**Application:** Routing low voltage cables and/or power cabling: Fiber Optic, Category 5, UTP, ScTP, Coax or any other low voltage cable; power cables (up to 600V) in horizontal applications.



**TE-70**

Base: [page F6](#)  
 Cover: [page F6](#)  
 Fittings: [page F6](#)

### 3 PAN-WAY U.S. Standard Screw-On Electrical/Communication Faceplates

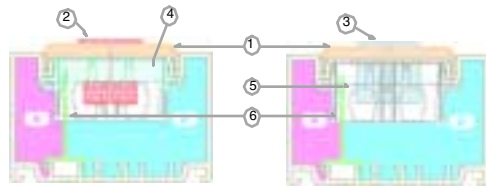

Data & Power

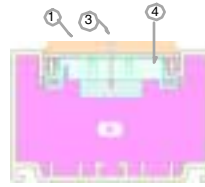

Power Only

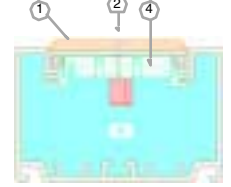

Data Only



- U.S. Standard screw-on electrical faceplate is used
- Can use most manufacturers' communication module frames (see chart on [page vii](#))

Areas (in <sup>2</sup> )	A	B
Data & Power	1.65	3.66
Data Only	—	6.80
Power Only	7.20	—

Components Required	Data Only	Power Only	Data & Power	See Page
1. U.S. Standard Screw-On Electrical/Comm. Faceplate(s) (CPG shown)	X	X	X	<a href="#">A3-A4</a>
2. Standard Communication Module Frame	X		X	<a href="#">vii</a>
3. <b>PAN-WAY</b> Electrical Outlet (ERU20)		X	X	<a href="#">A4</a>
4. Device Mounting Bracket (T70DB-X shown)	X	X	X	<a href="#">FZ</a>
5. Hanging Box (TE70HB shown)			X	<a href="#">FZ</a>
6. Divider Wall (TE70DW shown)			X	<a href="#">F6</a>

### 4 U.S. Standard Screw-On Communication Faceplates

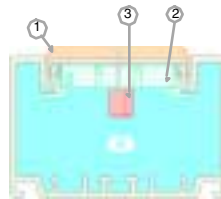

Data Only

- Uses most manufacturers' communication faceplates
- Panduit® Styles available, for more information refer to [page xii](#)

Areas (in <sup>2</sup> )	A	B
Data Only	—	7.18

Components Required	Data Only	See Page
1. Most Mfg. U.S. Screw-On Standard Comm. Faceplate	X	—
2. Device Mounting Bracket (T70DB-X shown)	X	<a href="#">FZ</a>
3. Manufacturers' inserts and/or modules	X	—

Note: For power and data applications use with configuration #3 above or with configuration #1 shown on previous page

## Type TE-70 Surface Raceway Base & Cover

**PAN-WAY** Type TE-70 Surface Raceway is a large capacity, multi-channel system used to route, protect, and conceal data, voice, video and power cabling systems.

### Type TE-70 System Benefits:

- Power rated to 600V(UL), 300V(CSA) meets new **UL5A standard** and CSA 22.2 No. 62-93 standards
- Extremely tamper resistant
- Compatible with:
  - **PAN-WAY** Snap-On Faceplates
  - Any U.S. Standard Screw-On Electrical/Communication Faceplates

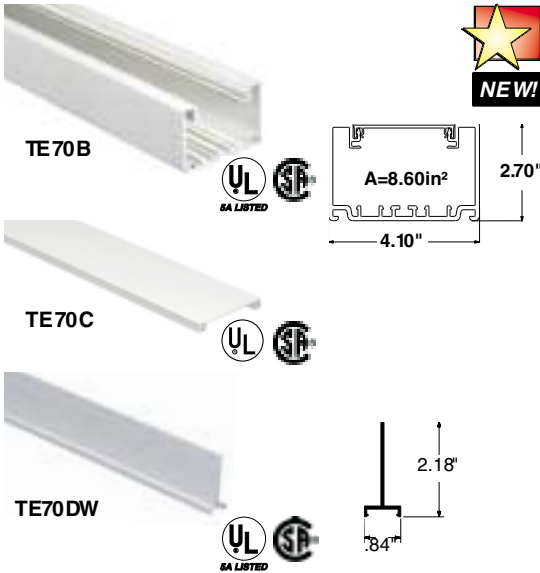

Part Number	Std. Ctn. Qty.	Part Number	Std. Ctn. Qty.	Colors◆
-------------	----------------	-------------	----------------	---------

#### Type TE-70 Raceway Base

8 ft. lengths		10 ft. lengths		
TE70BIW8	32 ft.	TE70BIW10	40 ft.	Off White
TE-70 Raceway Base in 8 or 10 ft lengths supplied with pre-punched mounting holes.				

#### Type T-70 Raceway Cover

T70CIW8	96 ft.	T70CIW10	120 ft.	Off White
TE-70 Raceway tamper resistant cover in 8 or 10 ft lengths.				

#### Type TE-70 Divider Wall

TE70DW8	64 ft.	TE70DW10	80 ft.	Lt. Gray
---------	--------	----------	--------	----------

◆ All parts listed in Off White (IW) color. To order other colors substitute EI (Electric Ivory), IG (Light Gray), and WH (White). Contact factory for details.

#### ORDERING INFORMATION:

Order number of feet required, in multiples of Standard Length Increment.

### UL CSA Type TE Raceway Fittings

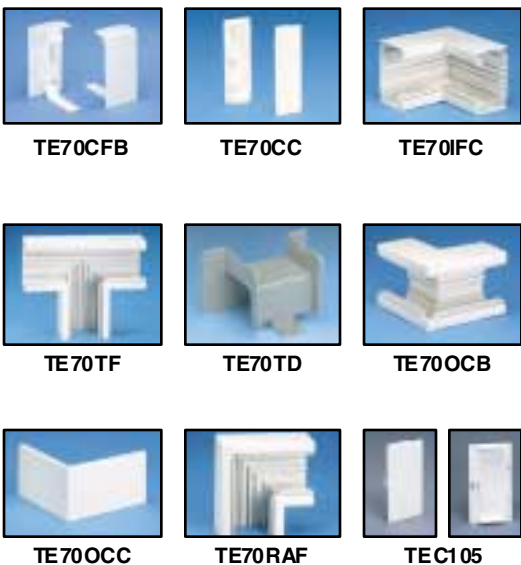

Part Number	Description	Colors◆	Std. Pkg. Qty.	Std. Ctn. Qty.
TE70CFBIW-X	Base Coupler Fitting (2 halves = 1 piece)	Off White	10 pcs.	100 pcs.
TE70CCIW-X	Cover Coupler Fitting	Off White	10 pcs.	100 pcs.
TE70ICFIW	Inside Corner Fitting	Off White	1 pc.	10 pcs.
TE70TFW	Tee Fitting	Off White	1 pc.	10 pcs.
TE70TD	Raceway Divider Insert (power and data applications) Separates power and data cabling within tee fitting	Gray	1 pc.	10 pcs.
TE70OCBIW	Outside Corner Base Fitting	Off White	1 pc.	10 pcs.
TE70OCCIW	Outside Corner Cover Fitting	Off White	1 pc.	10 pcs.
TE70RAFIW	Right Angle Fitting	Off White	1 pc.	10 pcs.
TEC105IW	End Cap Fitting Concentric conduit breakouts: 3/4", 1/2"	Off White	1 pc.	10 pcs.

◆ All parts listed in Off White (IW) color. To order other colors substitute EI (Electric Ivory), IG (Light Gray), and WH (White). Contact factory for details.

#### ORDERING INFORMATION:

Order number of pieces required, in multiples of Standard Package.

For Technical Assistance, call: **888-506-5400, Ext. 8287** (outside the U.S., see inside back cover for International Directory)

## Type TE-70 Raceway Accessories



TMB105-X



Part Number	Description	Color	Std. Pkg. Qty.	Std. Ctn. Qty.
-------------	-------------	-------	----------------	----------------

### Mounting Bracket

TMB105-X	Brackets are attached to wall. TE-70 raceway is then snapped onto brackets.	—	10 pcs.	100 pcs.
----------	-----------------------------------------------------------------------------	---	---------	----------



T70DB-X



### Device Mounting Bracket

T70DB-X	Used to mount NEMA standard single gang electrical outlets and communication devices with either screw-on or snap-on single gang faceplates.	Gray	10 pcs.	100 pcs.
---------	----------------------------------------------------------------------------------------------------------------------------------------------	------	---------	----------



TE70HB



### Hanging Box

TE70HB	Used to mount NEMA standard single gang electrical outlets or devices with either screw-on or snap-on single gang faceplates when there are communications cables in the raceway.	Gray	1 pc.	10 pcs.
--------	-----------------------------------------------------------------------------------------------------------------------------------------------------------------------------------	------	-------	---------

### Wire Retainer

T70WR-X	Holds wires in place. Will not interfere with cover installation.	Gray	10 pcs.	100 pcs.
---------	-------------------------------------------------------------------	------	---------	----------

### ORDERING INFORMATION:

Order number of feet required, in multiples of Standard Length Increment.



T70WR-X



## PAN-WAY™ Snap-On Faceplates

for use with TE-70 Raceway



- TE-70 is fully compatible with **PAN-WAY** Snap-On Faceplates
- Available for Communication and Electrical Applications



### PAN-WAY Snap-On Faceplates

Electrical/Communication Faceplates . . . . . A3

Electrical/Communication Faceplates

(with screw holes to mount a module frame) . A3

## Fill Capacities for TE-70 Raceway

Use the wirefill configurations below along with the wirefill information contained on the next two pages as a guide in selecting the proper size raceway. The maximum amounts may vary according to the wire installation methods, straightness of wires, etc.

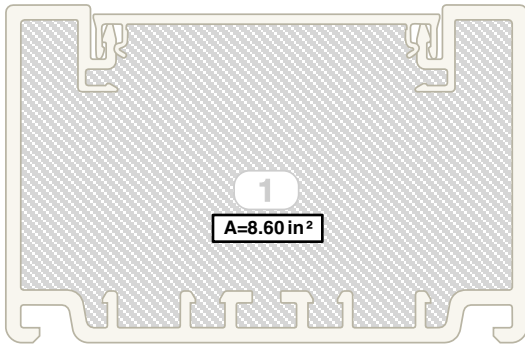

**Wirefill #1:** TE-70 Raceway with no devices

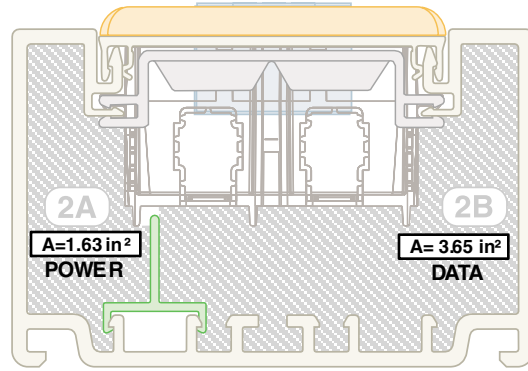

**Wirefill #2:** Power & Data using Hanging Box and Device Bracket

*Includes: Hanging Box, Divider Wall, Wire Retainer, T70P Faceplate, Snap-On Electrical/Communication Faceplate, Not shown for clarity: U.S. Standard Electrical Outlet, Standard Communication Module Frame and Communication Modules.*

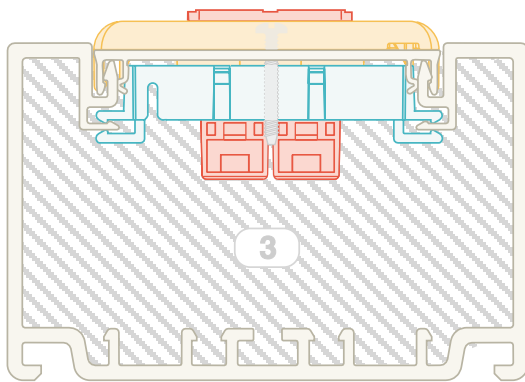

**Wirefill #3:** Data Only using U.S. Standard Screw-On Electrical/Communication Faceplates

*Includes: Device Bracket, U.S. Standard Screw-On Electrical/Communication Faceplate, Standard Communication Module Frame, and Communication Modules*

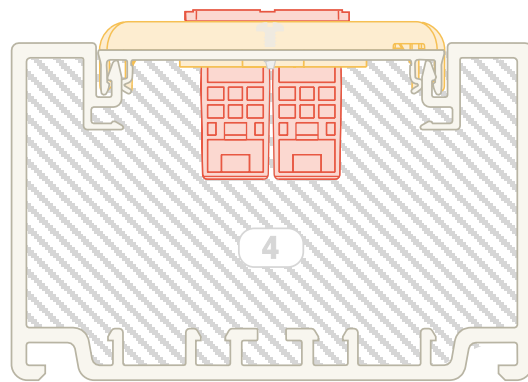

**Wirefill #4:** Data Only using Snap-On Communication Faceplates (with screw holes to mount a module frame)

*Includes: Snap-On Communication Faceplate (with screw holes to mount a module frame), Standard Communication Module Frame, and Communication Modules*

## Fill Capacities for TE-70 Raceway

This information is to be used as a guide in selecting the proper size raceway. The maximum amounts may vary according to the wire installation methods, straightness of wires, etc. Reference wirefill configurations on [page E8](#).

**SPEC=40% wirefill**—the recommended design in cable capacity. Leaves room for future moves, adds and changes

**MAX=60% wirefill**—the maximum cable quantity based on cable interweaving and packing factors or UL temp. rise test (electrical)

TE-70 FILL CAPACITIES

### Fill Capacity Table for: ·Electrical ·Voice Grade 24 AWG UTP ·Data Grade 24 AWG UTP

Raceway Channel Wirefill Configurations	See Fill #	Electrical Cables			Voice Grade Cables						Data Grade Cables			
		AWG			24 AWG UTP CM/CMR						24 AWG UTP CM			
		14	12	10	2 pr		3 pr		4 pr		25 pr		Cat 5 4 pr	
		THHN/T90			DIA.= 0.120		DIA.= 0.150		DIA.= 0.190		DIA.=0.422		DIA.=0.217	
		0.105	0.122	0.153	FILL		FILL		FILL		FILL		FILL	
MAX	MAX	MAX	SPEC	MAX	SPEC	MAX	SPEC	MAX	SPEC	MAX	SPEC	MAX	SPEC	MAX
<b>Wirefill #1: TE-70 with No Devices</b>	1	28	24	20	304	456	195	292	121	182	25	37	93	140
<b>Wirefill #2: Power &amp; Data using Hanging Box &amp; Device Bracket</b>	2A	17	14	14	58	87	37	55	23	35	5	7	18	26
	2B	**	**	**	129	194	83	124	52	77	10	16	39	59
<b>Wirefill #3: Data Only using U.S. Standard Screw-On Faceplates (see <a href="#">page E8</a>)</b>	3	**	**	**	252	378	161	242	100	151	20	31	77	116
<b>Wirefill #4: Data Only using Snap-On Communication Faceplates (with screw holes to mount a module frame) (see <a href="#">page E8</a>)</b>	4	**	**	**	293	439	187	281	117	175	24	35	89	134

NOTE: See [page xiv-xv](#) for further explanation of wirefill data.  
 \*\* Not power configuration

### Fill Capacity Table for: ·Data Grade 22 AWG UTP ·Data Grade 24, 22 AWG STP ·1A STP

Raceway Channel Wirefill Configurations	See Fill #	Data Grade Cables															
		24 AWG STP CM				22 AWG UTP CM				22 AWG STP CM				1A 22 AWG STP CM			
		25 pr		4 pr		25 pr		4 pr		25 pr		4 pr		25 pr		4 pr	
		DIA.=0.512		DIA.=0.250		DIA.= 0.544		DIA.= 0.234		DIA.=0.635		DIA.=0.286		DIA.=0.430			
		FILL		FILL		FILL		FILL		FILL		FILL		FILL			
SPEC	MAX	SPEC	MAX	SPEC	MAX	SPEC	MAX	SPEC	MAX	SPEC	MAX	SPEC	MAX	SPEC	MAX		
<b>Wirefill #1: TE-70 with No Devices</b>	1	17	25	70	105	15	22	80	120	11	16	54	80	24	36		
<b>Wirefill #2: Power &amp; Data using Hanging Box &amp; Device Bracket</b>	2A	3	5	13	20	3	4	15	23	2	3	10	15	4	7		
	2B	7	11	30	45	6	9	34	51	5	7	23	34	10	15		
<b>Wirefill #3: Data Only using U.S. Standard Screw-On Faceplates (see <a href="#">page E8</a>)</b>	3	14	21	58	87	12	18	66	99	9	13	44	67	20	29		
<b>Wirefill #4: Data Only using Snap-On Communication Faceplates (with screw holes to mount a module frame) (see <a href="#">page E8</a>)</b>	4	16	24	67	101	14	21	77	115	10	16	52	77	23	34		

NOTE: See [page xiv-xv](#) for further explanation of wirefill data.

## Fill Capacities for TE-70 Raceway

This information is to be used as a guide in selecting the proper size raceway. The maximum amounts may vary according to the wire installation methods, straightness of wires, etc. Reference wirefill configurations on [page E8](#).

**SPEC=40% wirefill**—the recommended design in cable capacity. Leaves room for future moves, adds and changes

**MAX=60% wirefill**—the maximum cable quantity based on cable interweaving and packing factors or UL temp. rise test (electrical)

### Fill Capacity Table for: Coax Cables

Raceway Channel Wirefill Configurations	See Fill #	Coax Cables									
		RG6/u		RG11/u		RG58/u		RG59/u		RG62A/u	
		DIA.=0.270		DIA.=0.405		DIA.=0.193		DIA.=0.242		DIA.=0.242	
		FILL		FILL		FILL		FILL		FILL	
		SPEC	MAX	SPEC	MAX	SPEC	MAX	SPEC	MAX	SPEC	MAX
<b>Wirefill #1: TE-70 with No Devices</b>	1	60	90	27	40	118	176	75	112	75	112
<b>Wirefill #2: Power &amp; Data using Hanging Box &amp; Device Bracket</b>	2A	11	17	5	8	22	33	14	21	14	21
	2B	26	38	11	17	50	75	32	48	32	48
<b>Wirefill #3: Data Only using U.S. Standard Screw-On Faceplates (see <a href="#">page E8</a>)</b>	3	50	75	22	33	97	146	62	93	62	93
<b>Wirefill #4: Data Only using Snap-On Communication Faceplates (with screw holes to mount a module frame) (see <a href="#">page E8</a>)</b>	4	58	87	26	39	113	170	72	108	72	108

NOTE: See [page xiv-xv](#) for further explanation of wirefill data.

### Fill Capacity Table for: Fiber Optic Cable (62.5/125mm) · Signal Cables

Raceway Channel Wirefill Configurations	See Fill #	Fiber Optic Cables (62.5/125mm)						Signal Cables							
		2 Strand		4 Strand		6 Strand		18AWG		20 AWG		22 AWG		24 AWG	
		DIA.=0.175		DIA.=0.175		DIA.=0.210		DIA.=0.066		DIA.=0.057		DIA.=0.050		DIA.=0.044	
		FILL		FILL		FILL		FILL		FILL		FILL		FILL	
		SPEC	MAX	SPEC	MAX	SPEC	MAX	SPEC	MAX	SPEC	MAX	SPEC	MAX	SPEC	MAX
<b>Wirefill #1: TE-70 with No Devices</b>	1	143	215	143	215	99	149	1006	1509	1349	2023	1753	2629	2264	3395
<b>Wirefill #2: Power &amp; Data using Hanging Box &amp; Device Bracket</b>	2A	27	41	27	41	19	28	191	286	256	383	332	498	429	644
	2B	61	91	61	91	42	63	427	640	572	859	744	1116	961	1441
<b>Wirefill #3: Data Only using U.S. Standard Screw-On Faceplates (see <a href="#">page E8</a>)</b>	3	118	178	118	178	82	123	833	1249	1117	1675	1451	2177	1874	2811
<b>Wirefill #4: Data Only using Snap-On Communication Faceplates (with screw holes to mount a module frame) (see <a href="#">page E8</a>)</b>	4	138	206	138	206	96	143	967	1451	1297	1946	1686	2528	2177	3265

NOTE: See [page xiv-xv](#) for further explanation of wirefill data.

### Raceway Cutting Instructions:

For small quantities, use a fine tooth handsaw. For larger quantities use a plastic cutting saw blade for clean, burr-free cuts. Recommend: *Carbide 80T or 100T; .090" thickness, .125" kerf.*

## **PAN-WAY™ T Surface Raceway**

### **Type T for Power and Communications Cabling (including Fiber Optic Cables)**

**PAN-WAY** Type T Surface Raceway provides a complete system for routing, protecting and terminating both your communications and power cabling systems. The multi-channel design keeps electrical and communications cables separated. This gives you the

flexibility to install power cables first, then easily add communication cables later. Type T Raceway is tamper-resistant while also allowing you access for moves, adds and changes.



### **Panduit *PAN-WAY* T Raceway provides the following key benefits:**

- Large capacity multi-channel raceway for power and communications applications
- Superior tamper resistance, ideal for school and university applications
- Two sizes to match your application needs
- Power Rated to 600V (UL) **meets new UL5A standards**, 300V (CSA) meets CSA 22.2 No. 62-93 standards
- Wide selection of fittings to speed installation
- A selection of molded covers for power and/or communications cabling

### **Compatible with:**

- Standard communication module frames used with **PAN-WAY** faceplates
- **PAN-WAY** Snap-On Faceplates for communications cabling
- Most manufacturers' standard faceplates
- A selection of Pre-cut Covers are available for mounting standard NEMA electrical outlets and faceplates (for T130 only)

**Table of Contents**

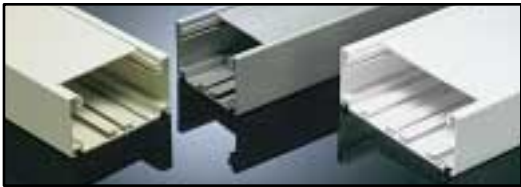

**PAN-WAY™ Type T Raceway** Page  
 T130 and T170 Raceway  
 ① ② ③ ④ Raceway Base & Cover . . . . . G9  
 Configurations . . . . . G4-G7  
 Fill Capacities . . . . . G13-G16



**PAN-WAY Type T Raceway**  
 Raceway Accessories . . . . . G9



**PAN-WAY Type T Raceway**  
 Type T130 & T170 Fittings . . . . . G10



**PAN-WAY Type T Box & Pre-Cut Covers for NEMA Faceplates**  
 Type T Box . . . . . G10  
 Pre-Cut Covers . . . . . G10



**PAN-WAY Type T Snap-On Modular Furniture Faceplate Pre-Cut Covers**  
 Pre-Cut Covers . . . . . G11



**PAN-WAY Type T130 Hanging Device Bracket & Molded Covers**  
 Device Bracket . . . . . G11  
 Molded Covers . . . . . G12



**PAN-WAY™ Type T Raceway Roadmap**

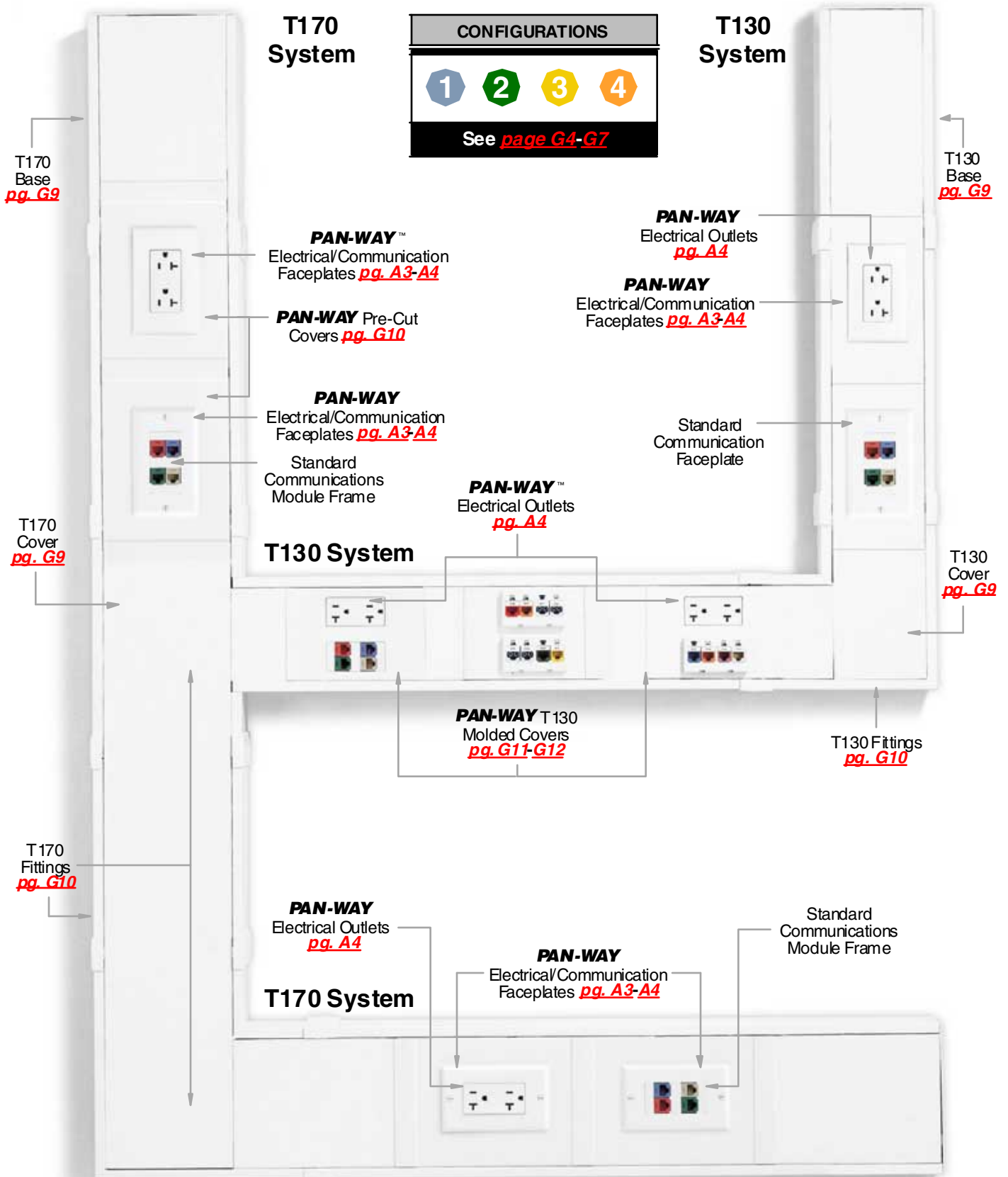

**PAN-WAY™ Type T130 Raceway Configurations**

**Application:** Routing communication cables and/or power cabling: Fiber Optic, Category 5, UTP, ScTP, Coax, or any low voltage cable; power cables (up to 600V).

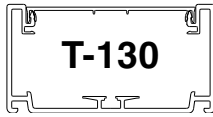

**T-130**

Base: [page G9](#)  
 Cover: [page G9](#)  
 Fittings: [page G10](#)

TYPE T130 RACEWAY CONFIGURATIONS

**1 Alternative — T130 Snap-On Electrical/Communications Faceplates**

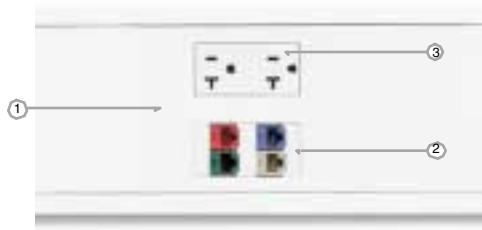
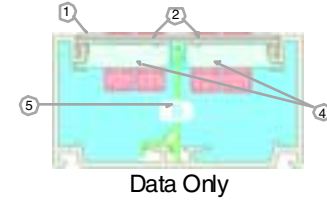
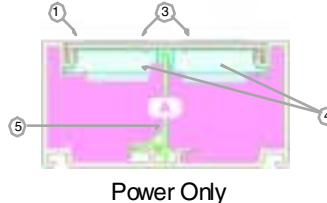
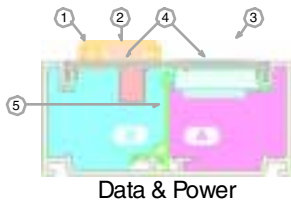

Data & Power Shown

Areas (in <sup>2</sup> )	A	B
Data & Power	3.94	3.30
Data Only	—	6.82
Power Only	7.67	—

- Snap-On Faceplates provide a superior appearance (no screws required)
- Can use most manufacturers' communication module frames (see chart on [page vii](#))

Components Required	Data Only	Power Only	Data & Power	See Page
1. T130 Snap-On Electrical/Communication Faceplate(s) (T130RMC2 shown)	X	X	X	<a href="#">G11-G12</a>
2. Standard Communication Module Frame	X		X	<a href="#">vii</a>
3. <b>PAN-WAY</b> Electrical Outlet (ERU20 shown)		X	X	<a href="#">A4</a>
4. (2) Gangable Device Mounting Brackets (T130DBD shown)	X	X	X	<a href="#">G12</a>
5. Divider Wall (TD688 shown)	X	X	X	<a href="#">G9</a>

**2 Alternative — T130 Snap-On Covers for Modular Furniture Faceplates**

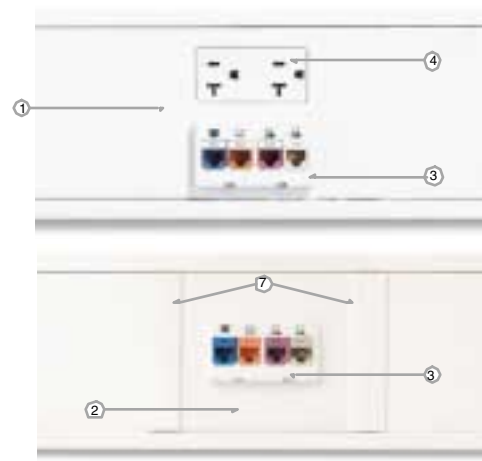

Areas (in <sup>2</sup> )	A	B
Data & Power	4.00	4.55
Data Only	—	10.34

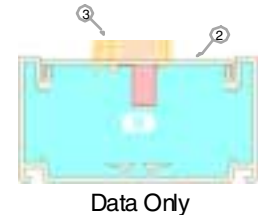
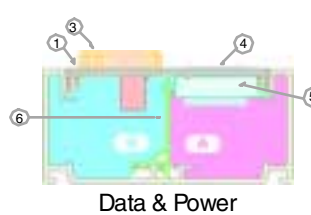

- Compatible with modular furniture faceplates with a cutout dimension 2.42" x 4.06"
- Panduit® Styles available, for more information refer to bottom of [page xii](#)

Components Required	Data Only	Power Only	Data & Power	See Page
1. T130 Snap-On Electrical/Communication Faceplate (for modular furniture faceplates) (T130TRMC shown)			X	<a href="#">G11</a>
2. T130 Punched Cover (T130K1 shown)	X			<a href="#">G11</a>
3. Most manufacturers' modular furniture faceplates	X		X	—
4. <b>PAN-WAY</b> Electrical Outlet (ERU20 shown)			X	<a href="#">A4</a>
5. Hanging Device Bracket (T130DB-X shown)			X	<a href="#">G11</a>
6. Divider Wall (TD688 shown)			X	<a href="#">G9</a>
7. Cover Couplers (TCFC 130 shown)	X			<a href="#">G10</a>

Note: For power only applications see configuration #1 above or configuration #3 shown on next page

## PAN-WAY™ T130 Raceway Configurations Cont'd

**Application:** Routing communication cables and/or power cabling: Fiber Optic, Category 5, UTP, ScTP, Coax, or any low voltage cable; power cables (up to 600V).

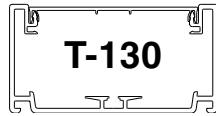

**T-130**

Base: [page G9](#)  
 Cover: [page G9](#)  
 Fittings: [page G10](#)

### 3 PAN-WAY U.S. Standard Screw-On Electrical/Communication Faceplates

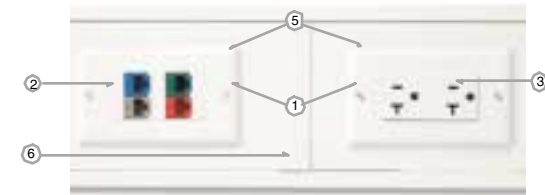
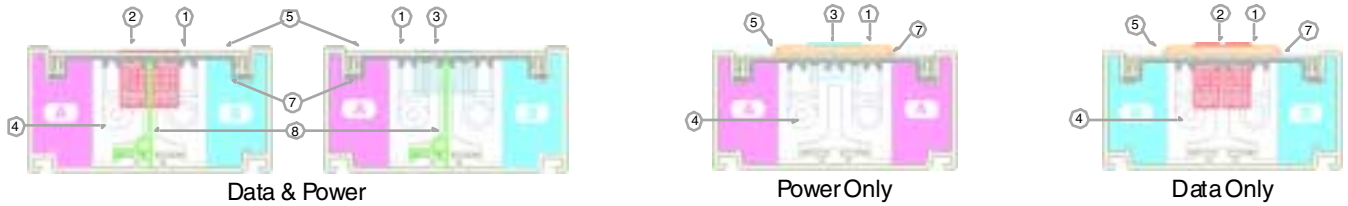

Areas (in <sup>2</sup> )	A	B
Data & Power	2.56	2.56
Data Only	—	2.56(x2)
Power Only	2.56(x2)	—

- U.S. standard screw-on electrical faceplate is used
- Can use most manufacturers' communication module frames (see chart on [page vii](#))

Components Required	Data Only	Power Only	Data & Power	See Page
1. U.S. Standard Screw-On Electrical/Comm. Faceplate(s) (CPG shown)	X	X	X	<a href="#">A3</a>
2. Standard Communication Module Frame	X		X	<a href="#">vii</a>
3. PAN-WAY Electrical Outlet (ERU20 shown)		X	X	<a href="#">A4</a>
4. Type T Box (TB5883 shown)	X	X	X	<a href="#">G10</a>
5. Pre-cut cover (T130G shown)	X	X	X	<a href="#">G10</a>
6. T 130 cover coupler fitting (TCFC130 shown)	X	X	X	<a href="#">G10</a>
7. Wire retainer (TWR130 shown)			X	<a href="#">G9</a>
8. Divider Wall (TD688 shown)			X	<a href="#">G9</a>

### 4 U.S. Standard Screw-On Communication Faceplates

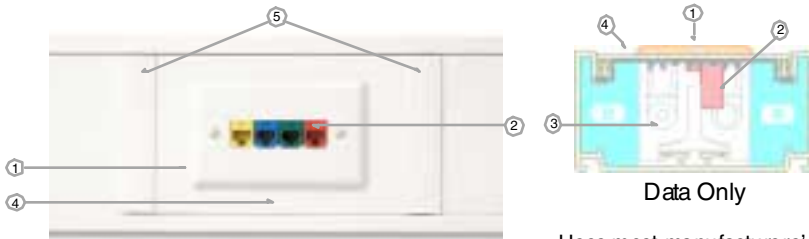

Areas (in <sup>2</sup> )	A	B
Data Only	—	2.56(x2)

- Uses most manufacturers' communication faceplates
- Panduit® Styles available, for more information refer to [page xii](#)

Components Required	Data Only	See Page
1. Most Mfg. U.S. Standard Screw-On Comm. Faceplate(s)	X	—
2. Manufacturers' inserts and/or modules	X	—
3. Type T Box (TB5883 shown)	X	<a href="#">G10</a>
4. Pre-cut cover (T130G shown)	X	<a href="#">G10</a>
5. T 130 cover coupler fitting (TCFC130 shown)	X	<a href="#">G10</a>

Note: For power only or power and data applications use power components from configuration #3 above.

**PAN-WAY™ Type T170 Raceway Configurations**

**Application:** Routing communication cables and/or power cabling: Fiber Optic, Category 5, UTP, ScTP, Coax, or any low voltage cable; power cables (up to 600V).



**T-170**

Base: [page G9](#)  
 Cover: [page G9](#)  
 Fittings: [page G10](#)

TYPE T170 RACEWAY CONFIGURATIONS

**1 Alternative — T170 Snap-On Electrical/Communications Faceplates**

This solution is not available for T170

**2 Alternative — T170 Snap-On Covers for Modular Furniture Faceplates**

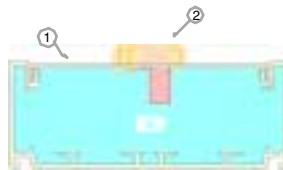
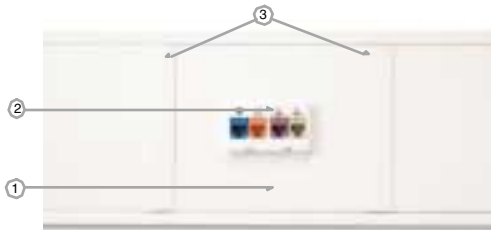

Data Only

- Compatible with modular furniture faceplates with a cutout dimension = 1.375" x 2.71"
- Panduit® Styles available, for more information refer to bottom of [page xii](#)

Areas (in <sup>2</sup> )	A	B
Data Only	—	13.66

Components Required	Data Only	Data & Power	See Page
1. T170 Punched Cover (T170K1 shown)	X		<a href="#">G11</a>
2. Most manufacturers' modular furniture faceplates	X	X	—
3. Cover Couplers (TCFC170 shown)	X		<a href="#">G10</a>

Note: For power only applications see configuration #3 shown on next page

## PAN-WAY™ T170 Raceway Configurations Cont'd

**Application:** Routing communication cables and/or power cabling: Fiber Optic, Category 5, UTP, ScTP, Coax, or any low voltage cable; power cables (up to 600V).

**T-170**

Base: [page G9](#)  
Cover: [page G9](#)  
Fittings: [page G10](#)

### 3 PAN-WAY U.S. Standard Screw-On Electrical/Communication Faceplates

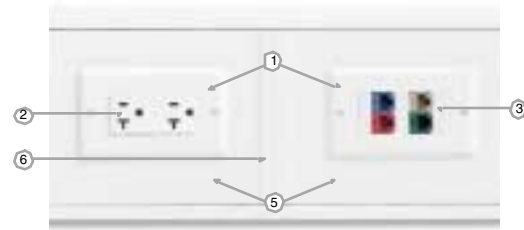
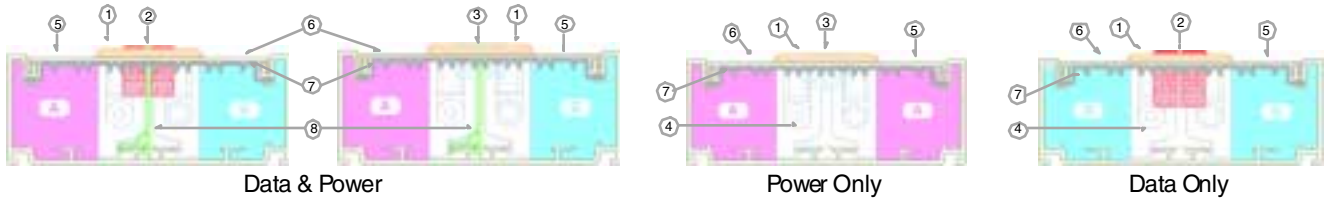

- U.S. Standard Screw-On Electrical/Communication faceplate is used
- Can use most manufacturers' communication module frames (see chart on [page viii](#))

Areas (in <sup>2</sup> )	A	B
Data & Power	4.25	4.25
Data Only	—	4.25(x2)
Power Only	4.25(x2)	—

Components Required	Data Only	Power Only	Data & Power	See Page
1. U.S. Standard Screw-On Electrical/Comm. Faceplate(s) (CPG shown)	X	X	X	<a href="#">A3-A4</a>
2. Standard Communication Module Frame	X		X	<a href="#">vii</a>
3. PAN-WAY Electrical Outlet (ERU20 shown)		X	X	<a href="#">A4</a>
4. Type T Box (TB5583 shown)	X	X	X	<a href="#">G10</a>
5. Pre-cut cover (T170G shown)	X	X	X	<a href="#">G10</a>
6. T 170 cover coupler fitting (TCFC170 shown)	X	X	X	<a href="#">G10</a>
7. Wire retainer (TWR170 shown)			X	<a href="#">G9</a>
8. Divider Wall (TD388 shown)			X	<a href="#">G9</a>

### 4 U.S. Standard Screw-On Communication Faceplates

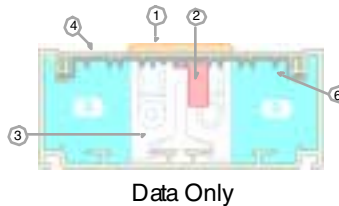
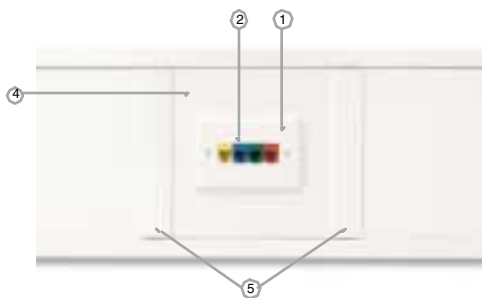

- Panduit® Styles available, for more information refer to [page xii](#)

Areas (in <sup>2</sup> )	A	B
Data Only	—	4.25(x2)

Components Required	Data Only	See Page
1. Most Mfg. U.S. Standard Screw-On Comm. Faceplate	X	—
2. Manufacturers' inserts and/or modules	X	—
3. Type T Box (TB5883 shown)	X	<a href="#">G10</a>
4. Pre-cut cover (T170G shown)	X	<a href="#">G10</a>
5. T 170 cover coupler fitting (TCFC170 shown)	X	<a href="#">G10</a>
6. Wire retainer (TWR170 shown)	X	<a href="#">G9</a>

Note: For power only or power and data applications use power components from configuration #3 above.

**PAN-WAY™ Surface Raceway Applications**



With a large capacity and multichannel capability, **PAN-WAY** Type T Surface Raceway can integrate both power and communication cabling systems while maintaining a neat and professional appearance throughout a testing lab.



A wide selection of fittings and device covers are available to speed installation and terminations.



To further organize cables, use Type T Raceway in conjunction with **PANDUCT**® Type G Wiring Duct to route and conceal device cable slack.



**PAN-WAY** Type T Surface Raceway, with its durable construction, can be used in industrial as well as office applications.



Type T Raceway allows you to run both communications and electrical cables anywhere they are needed on the production floor.



**T130RMC2** *page G12*

The new Type T130 Molded Covers cover 106 or rectangular outlets and will accept communications module frames (106 or rectangular frame) for multichannel applications

## PAN-WAY™ Type T Surface Raceway

**PAN-WAY** Type T Surface Raceway is a large capacity, multi-channel system used to route, protect, and conceal data, voice, video and power cabling systems.

### Type T System Benefits:

- Power rated to 600V(UL), 300V(CSA) meets new **UL5A** standard and CSA 22.2 No. 62-93 standards
- Superior tamper resistance for School & University applications
- Modular divider wall keeps power and data cables separated



TB130

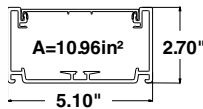

TB170

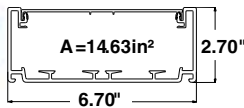

TD688

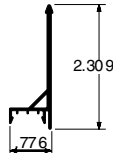

Part Number	Std. Ctn. Qty.	Part Number	Std. Ctn. Qty.	Colors◆
<b>8 ft. lengths</b>		<b>10 ft. lengths</b>		
<b>Type T130 Raceway Base</b>				
TB130IW8	32ft.	TB130IW10	40ft.	Off White
<b>Type T130 Raceway Cover</b>				
TC130IW8	64ft.	TC130IW10	80ft.	Off White
<b>Type T170 Raceway Base</b>				
TB170IW8	32ft.	TB170IW10	20ft.	Off White
<b>Type T170 Raceway Cover</b>				
TC170IW8	64ft.	TC170IW10	60ft.	Off White
<b>Divider Wall</b>				
TD688	64ft.	TD6810	80ft.	Gray ONLY

◆ All parts listed in Off White (IW) color. To order other colors substitute EI (Electric Ivory), IG (Light Gray), and WH (White). Contact factory for details.

#### ORDERING INFORMATION:

Order number of feet required, in multiples of Standard Length Increment.

## Type T Raceway Accessories



TMB

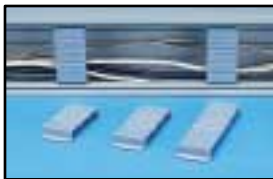

TWR



Part Number	Description	Used with Raceway	Std. Pkg. Qty.	Std. Ctn. Qty.
<b>Mounting Bracket</b>				
TMB130-X	Brackets are attached to wall. Type T raceway is then snapped onto brackets. Can be used as required anywhere along the raceway.	T130	10 pcs.	100 pcs.
TMB170-X		T170	10 pcs.	100 pcs.
<b>Wire Retainer</b>				
TWR130-X	Holds wires in place. Will not interfere with cover installation. To add cables, simply remove cover and loosen one side of the retainer.	T130	10 pcs.	100 pcs.
TWR170-X		T170	10 pcs.	100 pcs.

#### ORDERING INFORMATION:

Order number of pieces required, in multiples of Standard Package.



**Type T Raceway Fittings**



TCFB  
(at right)  
TCFC  
(at left)



TIC



TOCB



TRA



TOCC



TT



TEC



TR



TEE130

Part Number	Part Number	Colors◆	Std. Pkg. Qty.	Std. Ctn. Qty.
<b>T130</b>				
<b>T170</b>				
<b>Base Couplers</b>				
TCFB3070IW-X	TCFB3070IW-X	Off White	10 pcs.	100 pcs.
<b>Cover Couplers</b>				
TCFC130IW-X	TCFC170IW-X	Off White	10 pcs.	100 pcs.
<b>Inside Corner Fitting</b>				
TIC130IW	TIC170IW	Off White	1 pc.	10 pcs.
<b>Outside Corner Fitting Base</b>				
TOCB130IW	TOCB170IW	Off White	1 pc.	10 pcs.
<b>Outside Corner Fitting Cover</b>				
TOCC130IW	TOCC170IW	Off White	1 pc.	10 pcs.
<b>Right Angle Fitting</b>				
TRA130IW	TRA170IW	Off White	1 pc.	100 pcs.
<b>Tee Fitting</b>				
TT130IW	TT170IW	Off White	1 pc.	10 pcs.
<b>End Cap Fitting</b>				
TEC130IW	TEC170IW	Off White	1 pc.	10 pcs.
<b>Reducer Fitting</b>				
<b>T170 to T130</b>				
TR170X130IW		Off White	1 pc.	10 pcs.
<b>T130</b>				
<b>Entrance End</b>				
TEE130IW		Off White	1 pc.	10 pcs.

◆ All parts listed in Off White (IW) color. To order other colors substitute EI (Electric Ivory), IG (Light Gray), and WH (White). Contact factory for details.

**ORDERING INFORMATION:**

Order number of feet required, in multiples of Standard Length Increment

**PAN-WAY™ Type T Box and Pre-Cut Cover (for Mounting Standard NEMA Faceplates)**



TB5583-V



TBSR-Q



**Pre-Cut Cover for Type T Box & NEMA Faceplates**

- Cover Length = 7.05" (179mm)
- Cutout Dimension = 2.42" x 4.06" (61.5 x 103mm)

Part Number	Description	Std. Pkg. Qty.	Std. Ctn. Qty.
<b>Type T Box</b>			
TB5583-V	3.28" (83.5mm) mounting holes, 2.17" (55mm) deep. For use with single gang NEMA standard electrical devices and faceplates. This box is used with U.S. electrical outlets.	5 pcs.	60 pcs.
<b>Raceway Box Strain Relief</b>			
TBSR-Q	Snaps onto TB5583-V Type T Box. Required to support cable connections in vertically mounted raceway applications.	25 pcs.	—

Part Number	Part Number	Colors◆	Std. Pkg. Qty.	Std. Ctn. Qty.
<b>T130</b>				
<b>T170</b>				
<b>Pre-Cut Cover for Type T Box &amp; NEMA Faceplates</b>				
T130GIW	T170GIW	Off White	1 pc.	10 pcs.
Used with all standard NEMA electrical faceplates. Use with 2 Cover Couplers.				

◆ All parts listed in Off White (IW) color. To order other colors substitute EI (Electric Ivory), IG (Light Gray), and WH (White). Contact factory for details.

**ORDERING INFORMATION:**

Order number of feet required, in multiples of Standard Length Increment.



## Snap-On Faceplate Pre-Cut Covers (for Snap-On Modular Furniture Faceplates)

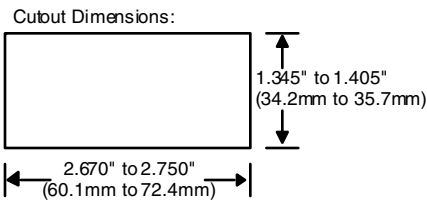
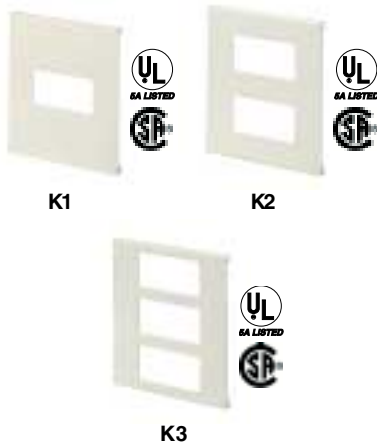

Maximum Panel Thickness: .090" (2.29mm)

Part Number	Part Number	Colors♦	Std. Pkg. Qty.	Std. Ctn. Qty.
-------------	-------------	---------	----------------	----------------

T130		T170		
<b>Pre-Cut Cover for One Snap-On Modular Furniture Faceplate</b>				
T130K1IW	T170K1IW	Off White	1 pc.	10 pcs.
<b>Pre-Cut Cover for Two Snap-On Modular Furniture Faceplates</b>				
T130K2IW	T170K2IW	Off White	1 pc.	10 pcs.
<b>Pre-Cut Cover for Three Snap-On Modular Furniture Faceplates</b>				
	T170K3IW	Off White	10 pc.	1 pcs.
Pre-cut cover for use with Snap-On Modular Furniture Faceplates. Use with two Cover Couplers shown on <a href="#">page G10</a> .				

Cover Lengths = 4.92" (125mm)

♦ All parts listed in Off White (IW) color. To order other colors substitute EI (Electric Ivory), IG (Light Gray), and WH (White). Contact factory for details.

**ORDERING INFORMATION:**

Order number of feet required, in multiples of Standard Length Increment.



## T130 Hanging Device Bracket & Molded Covers (for T130 Size Raceway ONLY)



Part Number	Description	Color♦	Std. Pkg. Qty.	Std. Ctn. Qty.
-------------	-------------	--------	----------------	----------------

<b>Hanging Device Bracket</b>				
T130DB-X	Used to quickly mount NEMA standard electrical receptacles (including GFCI) in T130 Raceway. Must be used with appropriate T130 Molded Cover.	Lt. Gray ONLY	10 pcs.	100 pcs.

<b>"Gangable" Device Bracket</b>				
T130DBD-X	Two (2) "Gangable" Device Brackets can be interlocked to mount multiple electrical and/or data devices in T130 base in multi-channel applications.	Lt. Gray ONLY	10 pcs.	100 pcs.

<b>Duplex Electrical Device Molded Cover</b>				
T130DMCIW	Covers NEMA standard 106 duplex electrical devices. Replaces faceplate and pre-cut raceway cover.	Off White	1 pc.	10 pcs.

<b>Double Duplex Electrical Device Molded Cover</b>				
T130DMC2IW	Covers 2 NEMA standard 106 duplex electrical devices. Replaces faceplate and pre-cut raceway cover.	Off White	1 pc.	10 pcs.

<b>Rectangular Electrical Device Molded Cover</b>				
T130RMCIW	Covers NEMA standard rectangular electrical devices. Replaces faceplate and pre-cut raceway cover. For use with T130DBD-X and TD688 divider wall.	Off White	1 pc.	10 pcs.

<b>Double Rectangular Electrical Device Molded Cover</b>				
T130RMC2IW	Covers 2 NEMA standard rectangular electrical devices. Replaces faceplate and pre-cut raceway cover. For use with T130DBD-X and TD688 divider wall.	Off White	1 pc.	10 pcs.

♦ All parts listed in Off White (IW) color. To order other colors substitute EI (Electric Ivory), IG (Light Gray), and WH (White). Contact factory for details.

**ORDERING INFORMATION:**

Order number of feet required, in multiples of Standard Length Increment.

**NOTE:** Can also be used for Communication Module Frames

**UL LISTED T130 Hanging Device Bracket & Molded Covers (cont.) (for T130 Size Raceway ONLY)**



T130LMC



T130TMC



T130TDMC



T130TRMC



T130FFMC



45x45 Modules (French) shown in T130FFMC.\*

Part Number	Description	Color◆	Std. Pkg. Qty.	Std. Ctn. Qty.
<b>Twist Lock Electrical Device Molded Cover</b>				
T130LMCIW	Covers NEMA standard twist lock electrical devices. Replaces faceplate and pre-cut raceway cover.	Off White	1 pc.	10 pcs.
<b>Communications Device Molded Cover</b>				
T130TMCIW	Provides proper sized opening to accept Snap-On Modular Furniture Faceplates.	Off White	1 pcs.	10 pcs.
<b>Communications and Duplex Electrical Device Molded Cover</b>				
T130TDMCIW	Covers NEMA standard duplex electrical devices and provides proper sized opening to accept Snap-On Modular Furniture Faceplates.	Off White	1 pc.	10 pcs.
<b>Communications and Rectangular Electrical Device Molded Cover</b>				
T130TRMCIW	Covers NEMA standard rectangular electrical devices and provides proper sized opening to accept Snap-On Modular Furniture Faceplates.	Off White	1 pc.	10 pcs.
<b>45X45 Device Cover (Accepts standard 45X45 modules*)</b>				
T130FFMCIW	Four 45X45mm devices snap into cover.	Off White	1 pc.	10 pcs.

◆All parts listed in Off White (IW) color. To order other colors substitute EI (Electric Ivory), IG (Light Gray), and WH (White). Contact factory for details.

**ORDERING INFORMATION:**

Order number of feet required, in multiples of Standard Length Increment.

\* Modules are not available from Panduit.

## Fill Capacities for T Raceway

Use the wirefill configurations below, along with the wirefill information contained in the following pages, as a guide in selecting the proper size raceway. The maximum amounts may vary according to the wire installation methods, straightness of wires, etc.

### T130 Raceway

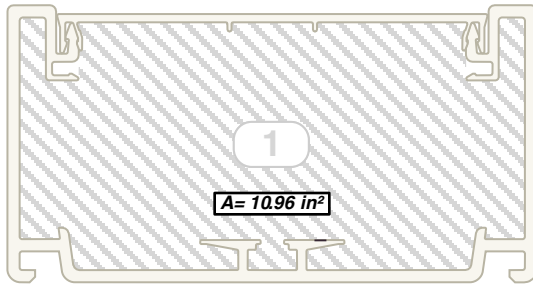

**Wirefill #1:** T130 Raceway with no devices

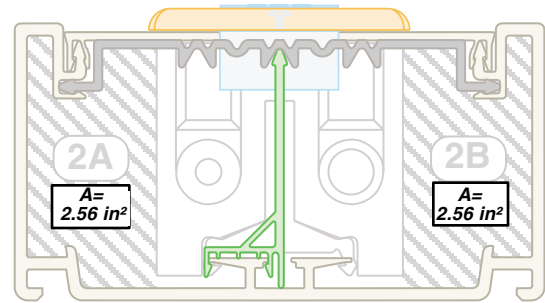

**Wirefill #2:** T130 Raceway—Power & Data using T Box & U.S. Standard Screw-On Electrical/Communication Faceplates

*Includes: TB5583-V Box, Divider Wall, Wire Retainer, U.S.*

*Standard Screw-On Electrical/Communication Faceplate; Data faceplate, communication module frame and modules (not shown)*

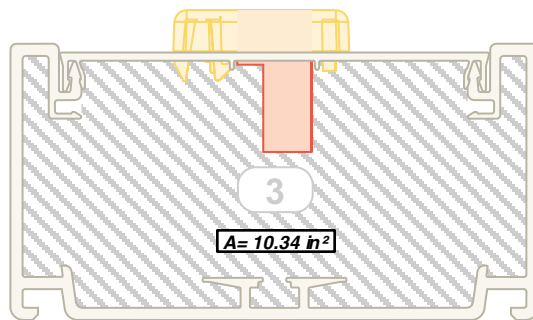

**Wirefill #3:** T130 Raceway—Data Only using Most Manufacturers' Modular Furniture Faceplates

*Includes: Most Manufacturers's Modular Furniture Faceplate, T130K1 Punched Cover and modules*

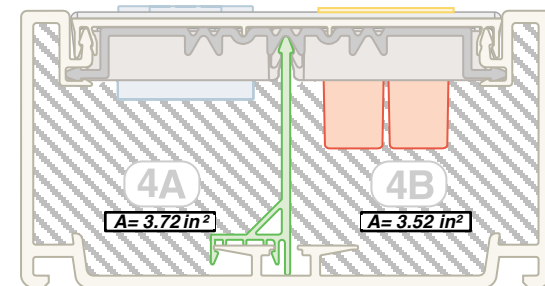

**Wirefill #4:** T130 Raceway—Power & Data using T130RMC2 Molded Cover

*Includes: T130RMC2 Molded Cover, Divider Wall, Wire Retainer, Gangable Device Bracket, U.S. Standard Electrical Outlet, Standard Communication Module Frame & Modules*

### Fill Capacities for T Raceway

Use the wirefill configurations below, along with the wirefill information contained in the following pages, as a guide in selecting the proper size raceway. The maximum amounts may vary according to the wire installation methods, straightness of wires, etc.

#### T170 Raceway

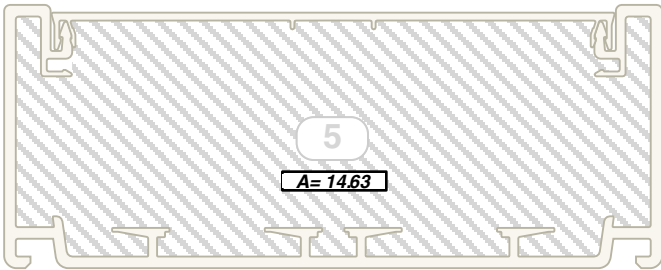

**Wirefill #5:** T170 Raceway with no devices

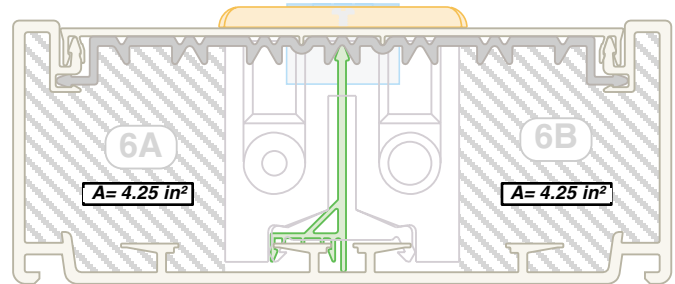

**Wirefill #6:** T170 Raceway—Power & Data using T Box & U.S. Standard Screw-On Electrical/Communication Faceplates

*Includes: TB5583-V Box, Divider Wall, Wire Retainer, U.S. Standard Screw-On Electrical/Communication Faceplate; Data faceplate (not shown)*

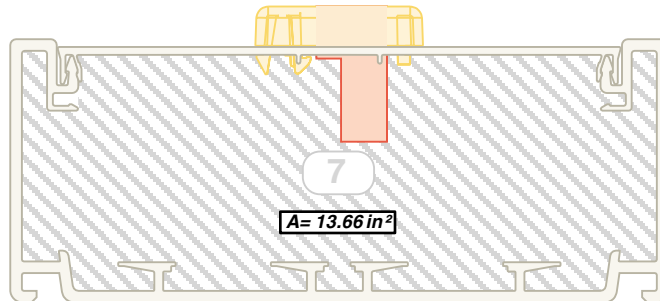

**Wirefill #7:** T170 Raceway—Data Only using Most Manufacturers' Modular Furniture Faceplates

*Includes: Most Manufacturers' Modular Furniture Faceplates, T170K1 Punched Cover and modules*

#### Raceway Cutting Instructions:

For small quantities, use a fine tooth handsaw. For larger quantities use a plastic cutting saw blade for clean, burr-free cuts. Recommend: *Carbide 80T or 100T; .090" thickness, .125" kerf.*

## Fill Capacities for T Raceway

This information is to be used as a guide in selecting the proper size raceway. The maximum amounts may vary according to the wire installation methods, straightness of wires, etc. Reference configurations on [page G13](#) thru [G14](#).

**SPEC=40% wirefill**—the recommended design in cable capacity. Leaves room for future moves, adds and changes

**MAX=60% wirefill**—the maximum cable quantity based on cable interweaving and packing factors or UL temp. rise test (electrical)

### Fill Capacity Table for: ·Electrical ·Voice Grade 24 AWG UTP ·Data Grade 24 AWG UTP

Raceway Channel Configurations	See Fig.	Electrical Cables			Voice Grade Cables						Data Grade Cables			
		AWG			24 AWG UTP CM/CMR						24 AWG UTP CM			
		14	12	10	2 pr		3 pr		4 pr		25 pr		Cat. 5 4 pr	
		THHN/T90			DIA.= 0.120		DIA.= 0.150		DIA.= 0.190		DIA.=0.422		DIA.=0.217	
		0.105	0.122	0.153	FILL		FILL		FILL		FILL		FILL	
	MAX	MAX	MAX	SPEC	MAX	SPEC	MAX	SPEC	MAX	SPEC	MAX	SPEC	MAX	
Wire fill #1: T130 with No Devices	1	31	28	26	388	582	248	372	155	232	31	47	119	178
Wire fill #2: T130 Power & Data using T-Box & U.S. Standard Screw-On Electrical/Communication Faceplates	2A	17	15	14	91	136	58	87	36	54	7	11	28	42
	2B	—	—	—	91	136	58	87	36	54	7	11	28	42
Wire fill #3: T130 Data Only using Modular Furniture Faceplates	3	—	—	—	353	530	226	339	141	211	29	43	108	162
Wire fill #4: Power & Data using the T130TRMC2 Molded Cover	4A	20	16	17	131	197	84	126	52	78	10	15	40	60
	4B	—	—	—	124	186	79	119	49	74	10	15	38	57
Wire fill #5: T170 with No Devices	5	31	28	26	518	777	331	497	207	310	42	63	158	237
Wire fill #6: T170 Power & Data using T-Box & U.S. Standard Screw-On Electrical/Communication Faceplates	6A	20	18	16	150	226	96	144	60	90	12	18	46	69
	6B	—	—	—	150	226	96	144	60	90	12	18	46	69
Wire fill #7: T170 with Modular Furniture Faceplate	7	—	—	—	483	725	309	464	193	289	39	59	148	222

TYPE T FILL CAPACITIES

### Fill Capacity Table for: ·Data Grade 22 AWG UTP ·Data Grade 24, 22 AWG STP ·1A STP

Raceway Channel Configurations	See Fig.	Data Grade Cables												1A 22 AWG STP CM			
		24 AWG STP CM				22 AWG UTP CM				22 AWG STP CM							
		25 pr		4 pr		25 pr		4 pr		25 pr		4 pr		25 pr		4 pr	
		DIA.=0.512		DIA.=0.250		DIA.= 0.544		DIA.= 0.234		DIA.=0.635		DIA.=0.286		DIA.=0.430			
		FILL		FILL		FILL		FILL		FILL		FILL		FILL			
	SPEC	MAX	SPEC	MAX	SPEC	MAX	SPEC	MAX	SPEC	MAX	SPEC	MAX	SPEC	MAX			
Wire fill #1: T130 with No Devices	1	21	32	89	134	19	28	102	153	14	21	68	102	30	45		
Wire fill #2: T130 Power & Data using T-Box & U.S. Standard Screw-On Electrical/Communication Faceplates	2A	5	7	21	31	4	7	24	36	3	5	16	24	7	11		
	2B	5	7	21	31	4	7	24	36	3	5	16	24	7	11		
Wire fill #3: T130 Data Only using Modular Furniture Faceplates	3	19	29	81	122	17	26	93	139	13	19	62	93	28	41		
Wire fill #4: Power & Data using the T130TRMC2 Molded Cover	4A	7	10	30	45	6	9	34	51	4	7	23	34	10	15		
	4B	6	10	28	43	6	9	32	49	4	6	23	32	9	14		
Wire fill #5: T170 with No Devices	5	28	43	119	179	25	38	136	204	18	28	91	137	40	60		
Wire fill #6: T170 Power & Data using T-Box & U.S. Standard Screw-On Electrical/Communication Faceplates	6A	8	12	35	52	7	11	40	59	5	8	26	40	12	18		
	6B	8	12	35	52	7	11	40	59	5	8	26	40	12	18		
Wire fill #7: T170 with Modular Furniture Faceplate	7	27	40	111	167	24	35	127	191	17	26	85	128	38	56		

NOTE: See [page xiv-xv](#) for further explanation of the wirefill data.

### Fill Capacities for T Raceway

This information is to be used as a guide in selecting the proper size raceway. The maximum amounts may vary according to the wire installation methods, straightness of wires, etc. Reference configurations on [page G13](#) thru [G14](#).

**SPEC=40% wirefill**—the recommended design in cable capacity. Leaves room for future moves, adds and changes

**MAX=60% wirefill**—the maximum cable quantity based on cable interweaving and packing factors or UL temp. rise test (electrical)

#### Fill Capacity Table for: Coax Cables

Raceway Channel Configurations	See Fig.	Coax Cables									
		RG6/u		RG11/u		RG58/u		RG59/u		RG62A/u	
		DIA.=0.270		DIA.=0.405		DIA.=0.193		DIA.=0.242		DIA.=0.242	
		FILL		FILL		FILL		FILL		FILL	
		SPEC	MAX	SPEC	MAX	SPEC	MAX	SPEC	MAX	SPEC	MAX
Wirefill #1: T130 with No Devices	1	77	115	34	51	150	225	95	143	95	143
Wirefill #2: T130 Power & Data using T-Box & U.S. Standard Screw-On Electrical/Communication Faceplates	2A	18	27	8	12	35	53	22	33	22	33
	2B	18	27	8	12	35	53	22	33	22	33
Wirefill #3: T130 Data Only using Modular Furniture Faceplates	3	70	105	31	47	137	205	87	130	87	130
Wirefill #4: Power & Data using the T130TRMC2 Molded Cover	4A	28	41	12	18	54	81	34	52	34	52
	4B	34	50	15	22	66	98	42	63	42	63
Wirefill #5: T170 with No Devices	5	102	153	45	68	200	300	127	191	127	191
Wirefill #6: T170 Power & Data using T-Box & U.S. Standard Screw-On Electrical/Communication Faceplates	6A	30	45	13	20	58	87	37	55	37	55
	6B	30	45	13	20	58	87	37	55	37	55
Wirefill #7: T170 with Modular Furniture Faceplate	7	95	143	42	64	187	280	119	178	119	178

#### Fill Capacity Table for: Fiber Optic Cable (62.5/125mm) Signal Cables

Raceway Channel Configurations	See Fig.	Fiber Optic Cables (62.5/125mm)						Signal Cables							
		2 Strand		4 Strand		6 Strand		18AWG		20 AWG		22 AWG		24 AWG	
		DIA.=0.175		DIA.=0.175		DIA.=0.210		DIA.=0.066		DIA.=0.057		DIA.=0.050		DIA.=0.044	
		FILL		FILL		FILL		FILL		FILL		FILL		FILL	
		SPEC	MAX	SPEC	MAX	SPEC	MAX	SPEC	MAX	SPEC	MAX	SPEC	MAX	SPEC	MAX
Wire fill #1: T130 with No Devices	1	182	274	182	274	127	190	1282	1923	1719	2578	2234	3351	2885	4327
Wire fill #2: T130 Power & Data using T-Box & U.S. Standard Screw-On Electrical/Communication Faceplates	2A	43	64	43	64	30	44	299	449	401	602	522	783	674	1011
	2B	43	64	43	64	30	44	299	449	401	602	522	783	674	1011
Wirefill #3: T130 Data Only using Modular Furniture Faceplates	3	166	249	166	249	115	173	1167	1751	1565	2348	2034	3051	2627	3940
Wire fill #4: Power & Data using the T130TRMC2 Molded Cover	4A	66	99	66	99	46	68	462	693	619	929	805	1208	1040	1559
	4B	80	120	80	120	55	83	561	842	753	1129	978	1468	1263	1895
Wire fill #5: T170 with No Devices	5	243	365	243	365	169	254	1711	2567	2294	3442	2982	4473	3851	5776
Wire fill #6: T170 Power & Data using T-Box & U.S. Standard Screw-On Electrical/Communication Faceplates	6A	71	106	71	106	49	74	497	746	667	1000	866	1299	1119	1678
	6B	71	106	71	106	49	74	497	746	667	1000	866	1299	1119	1678
Wirefill #7: T170 with Modular Furniture Faceplate	7	227	341	227	341	158	237	1598	2397	2142	3214	2784	4176	3595	5393

NOTE: See [page xiv-xv](#) for further explanation of the wirefill data.

## PAN-WAY™ Surface Raceway Cutting Tool



Part Number	Description	Std. Pkg. Qty.
<b>Surface Raceway Cutting Tool</b>		
SRT	Used to easily cut all sizes of Types LDP, LD2P, LD, LDS, CD and PD raceway. Leaves a clean, burr-free end on raceway. Can also be used to cut plastic conduit.	1 pc.

**ORDERING INFORMATION:**

Order number of pieces required, in multiples of Standard Package Quantity.

- Rugged, ratchet-action tool cuts surface raceway

## Floor Guard

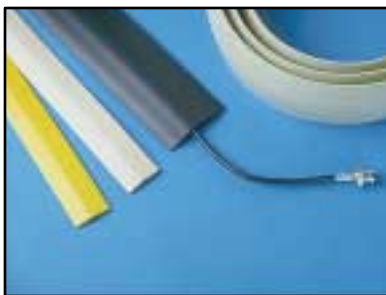

- Routes cabling over carpet, concrete or tile to prevent tripping
- Flexible vinyl material can be easily cut to length
- Cables slip into slit on base
- Adhesive mounting tape is supplied

Part Number	Length	Overall Size W x H	Wire Slot Size W x H	Color	Std. Pkg. Qty.
<b>FG1 – For single, twisted pair cables</b>					
FG1 EI6-A FG1 BR6-A FG1 YL6-A FG1 BL6-A	6 ft. 6 ft. 6 ft. 6 ft.	1.25" x .27" (3.18 x 6.9)	.25" x .27" (6.4 x 4.3)	Elec. Ivory Brown Safety Yellow Black	6 ft. 6 ft. 6 ft. 6 ft.
FG1 EI50-A FG1 BR50-A FG1 YL50-A FG1 BL50-A	50 ft. 50 ft. 50 ft. 50 ft.			Elec. Ivory Brown Safety Yellow Black	50 ft. 50 ft. 50 ft. 50 ft.

**FG3 – For multiple or larger cables**

FG3 EI6S-A FG3 BR6S-A FG3 YL6S-A FG3 BL6S-A	6 ft. 6 ft. 6 ft. 6 ft.	2.44" x .47" (62.0 x 12.0)	.68" x .28" (17.2 x 7.1)	Elec. Ivory Brown Safety Yellow Black	30 ft. 30 ft. 30 ft. 30 ft.
FG3 EI50-A FG3 BR50-A FG3 YL50-A FG3 BL50-A	50 ft. 50 ft. 50 ft. 50 ft.			Elec. Ivory Brown Safety Yellow Black	50 ft. 50 ft. 50 ft. 50 ft.

**ORDERING INFORMATION:**

Order number of feet required, in multiples Standard Package Quantity.

Note: Mounting tape is pre-applied only to FG3 in 6 ft. lengths.

## Magnet Strip



- Mounts adhesive backed raceway to metal surfaces such as desks, cabinets, modular furniture, etc.
- Flexible material can be easily cut to length

Part Number	Description	Std. Pkg. Qty.	Std. Ctn. Qty.
<b>FG3 – For multiple or larger cables</b>			
FMS75X6	6 ft. roll x .75" wide for use with PD3, LDP3, LD3, CD3, CD5 Raceway	1 pc.	10 pcs.
FMS100X6	6 ft. roll x 1.00" wide for use with PD6, LDP5, LDP10, LD5, LD10, CD10 Raceway	1 pc.	10 pcs.

**ORDERING INFORMATION:**

Order number of pieces required, in multiples of Standard Package Quantity.

# ***Open Office Products***





## PAN-POLE™ Aluminum Outlet Pole

**PAN-POLE** Aluminum Outlet Pole is an aesthetically pleasing dual channel pole for both power and communications outlets. The entrance fitting has been engineered to maintain the TIA/EIA required 1" bend radius for Category 5 and Fiber Optic Cabling. The **PAN-POLE** is tamper resistant to the end user, yet allows easy access to the installer for moves, adds, and changes.

**PAN-POLE** Aluminum Outlet Pole provides a totally integrated horizontal cabling solution for High Performance Copper, UTP, ScTP, Coax, Fiber Optic and Power Cabling Systems.



**NEW!** Available in  
11 & 13 Foot Lengths



Entry end bend radius fitting maintains 1" bend radius control of communication cable



**PAN-WAY** Snap-On Faceplates (with screw holes to mount a module frame) speed installation, lowering overall installed cost.

### Panduit **PAN-POLE** provides the following key benefits:

- Entry end bend radius control fitting, maintains the minimum 1" bend radius required under TIA/EIA 568-A and 569-A for high performance copper and fiber optic cabling systems
- UL-5 Listed and CSA Certified
- Tamper resistant plastic cover allows for customized placement of data outlets and is easy for the installer to cut and modify, reducing overall installation costs and costs associated with moves, adds, and changes
- Dual channel aluminum pole provides complete separation of power and data eliminating the need for two separate poles
- 2 colors available to complement surrounding decor

**Table of Contents**

**Power &  
Communication Pole**



**Communication Pole**



Page

**PAN-POLE™** Aluminum Outlet Pole  
 Power and Communications Pole . . . . . 16  
 Communication Only Pole . . . . . 16  
 2 3 4 Configurations . . . . . 14-15

**Accessories**

Standard Faceplate Bracket . . . . . 17  
 Standard Included Mounting Hardware . . . . . 17

Data Installation Instructions . . . . . 18  
 Fill Capacity Information. . . . . 19-111

**PAN-WAY™ Snap-On Faceplates**

Electrical/Communication Faceplates . . . . . A3  
 Electrical/Communication Faceplates  
 (with screw holes for module frames) . . . . . A3

**PAN-POLE™ Aluminum Outlet Pole—Roadmap**

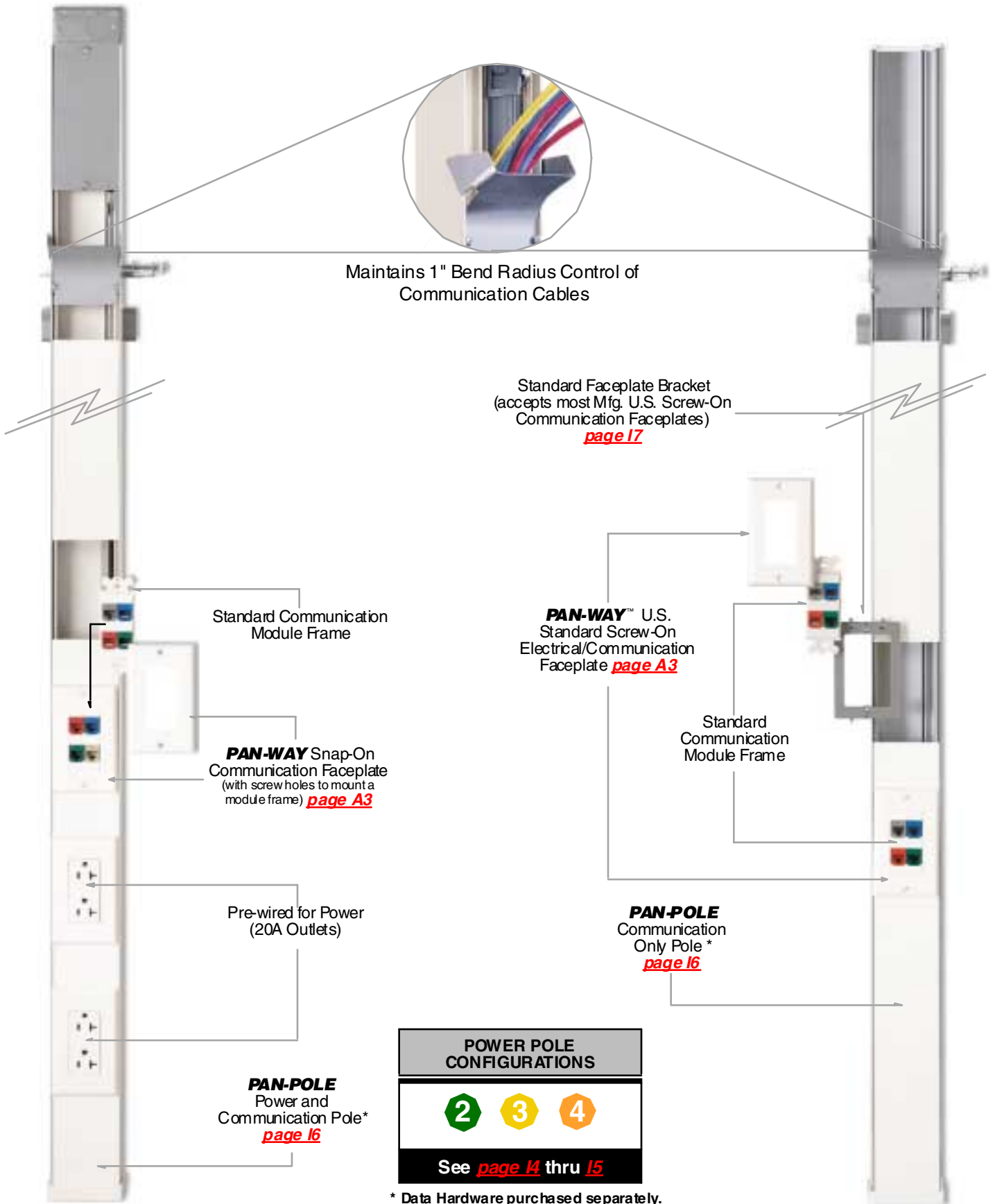

**PAN-POLE™ Aluminum Outlet Pole Configurations**

Application: Routing low voltage cables and/or power cabling: Fiber Optic, Category 5, UTP, ScTP, Coax or any other low voltage cable; power cables (up to 600V).

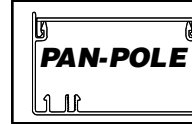

Components: [pg. I6](#)  
Accessories: [pg. I7](#)

**PAN-POLE ALUMINUM OUTLET POLE CONFIGURATIONS**

**1 PAN-WAY™ Snap-On Electrical/Communication Faceplates**

Configurations for this faceplate style not currently available

**2 PAN-WAY Snap-On Communication Faceplates (with screw holes to mount a module frame)**

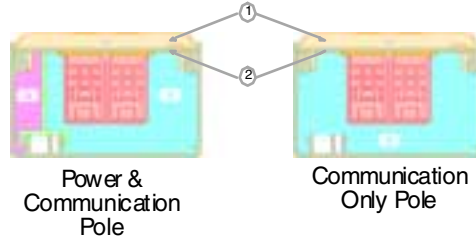
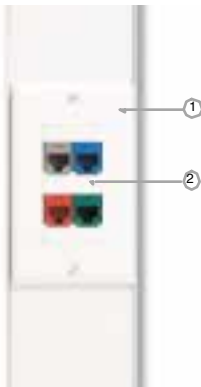

- Faceplate requires no device mounting bracket
- Can use most manufacturers' communication module frames (see chart on [page.vi](#))

Areas (in <sup>2</sup> )	A	B
Data & Power	.47	2.00
Data Only	—	2.70

Components Required	Power & Comm. Pole	Comm. Only Pole	See Page
1. Snap-On Communication Faceplate (with screw holes to mount a module frame) (T70PGS shown)	X	X	<a href="#">A3</a>
2. Standard Communication Module Frame	X	X	<a href="#">vii</a>

**3 PAN-WAY U.S. Standard Screw-On Electrical/Communication Faceplates**

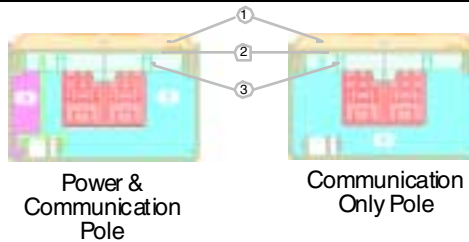
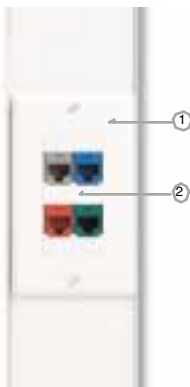

- U.S. Standard screw-on faceplate is used
- Can use most manufacturers' communication module frames (see chart on [page.vii](#))

Areas (in <sup>2</sup> )	A	B
Data & Power	.43	1.82
Data Only	—	2.46

Components Required	Power & Comm. Pole	Comm. Only Pole	See Page
1. U.S. Standard Screw-On Electrical/Communication Faceplate(s) (CPG shown)	X	X	<a href="#">A3</a>
2. Standard Communication Module Frame	X	X	<a href="#">vii</a>
3. Device Mounting Bracket (T70SDB-X shown)	X	X	<a href="#">I7</a>

## PAN-POLE™ Aluminum Outlet Pole Configurations

Application: Routing low voltage cables and/or power cabling: Fiber Optic, Category 5, UTP, ScTP, Coax or any other low voltage cable; power cables (up to 600V).

**Components:** [pg. I6](#)  
**Accessories:** [pg. I7](#)

### 4 U.S. Standard Screw-On Communication Faceplates

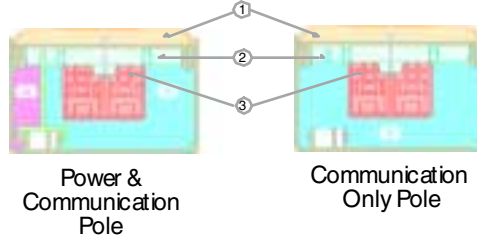
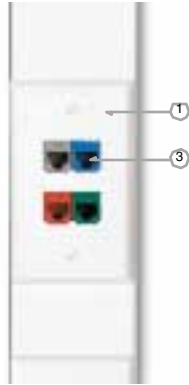

- Uses most manufacturers' NEMA standard 70mm communication faceplates
- Panduit® Styles available, for more information refer to [page xii](#)

Areas (in <sup>2</sup> )	A	B
Data Only	.43	1.82
Data Only	—	2.46

Components Required	Power & Comm. Pole	Comm. Only Pole	See Page
1. U.S. Standard Screw-On Communication Faceplate(s)	X	X	—
2. Device Mounting Bracket (T70SDB-X shown)	X	X	<a href="#">I7</a>
3. Manufacturers' inserts and/or communication modules	X	X	—

PAN-POLE ALUMINUM OUTLET POLE CONFIGURATIONS

**PAN-POLE™ Aluminum Outlet Pole Components**

**PAN-POLE Power and Communication Pole**

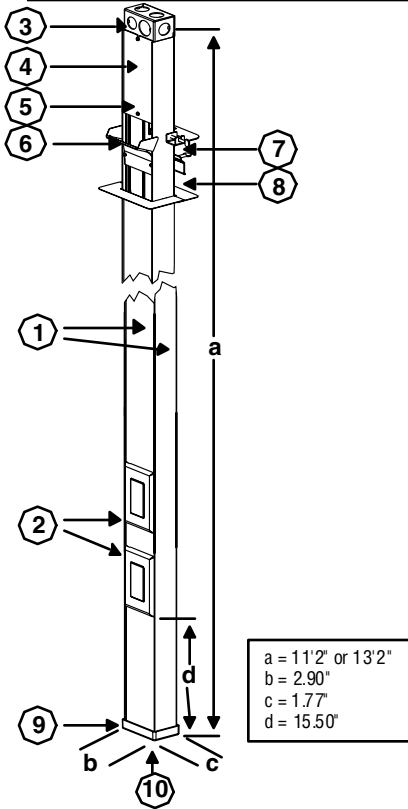

**PAN-POLE** Power and Communication Pole is a dual-channel aluminum pole for routing both power and communications cabling.

Part Number	Std. Pkg. Qty.	Part Number	Std. Pkg. Qty.	Colors
-------------	----------------	-------------	----------------	--------

11 ft. lengths		13 ft. lengths		
----------------	--	----------------	--	--

**PAN-POLE Power & Communications Pole**

PCPA11R20IW	1	PCPA13R20IW	1	Off White
PCPA11R20EI	1	PCPA13R20EI	1	Elec. Ivory

**PAN-POLE** Pole Assembly is supplied in 11 and 13 foot lengths for maximum ceiling heights of 10 or 12 feet.

Standard furnished factory assembled pole configurations include the following:

1. Aluminum extruded base with blank plastic cover
2. Two (2) 20A factory wired rectangular outlets with wiring fed through power channel to base of power entry box
3. Power entry box with 1/2", 3/4", and 1" conduit breakouts
4. 8" removable plate for power wiring connections
5. Ground screw pre-mounted behind removable plate

Standard furnished mounting hardware includes:

6. Entry end bend radius fitting for communication cabling (two mounting screws included)
7. Ceiling T-bar bracket (two mounting screws included)
8. Two (2) ceiling tile trim plates
9. End cap with two pre-drilled holes
10. End cap floor grip pad

Data hardware sold separately

**ORDERING INFORMATION:**

Order number of **PAN-POLE** Aluminum Outlet Poles required.

**PAN-POLE Communication Only Pole**

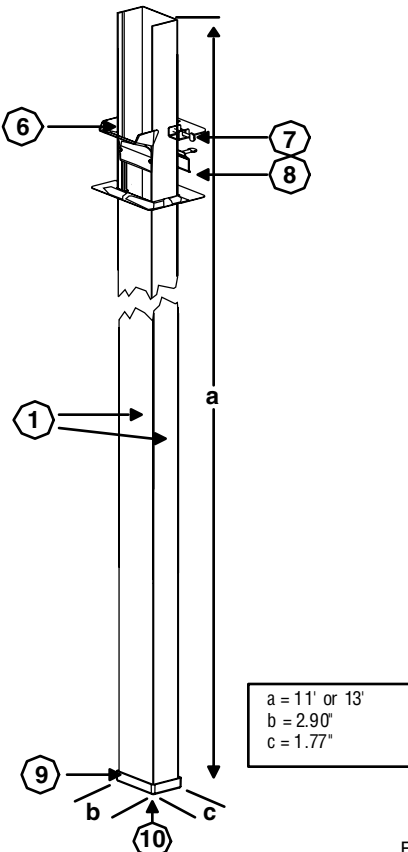

**PAN-POLE** Communication Only Pole is a single-channel aluminum pole for routing communication cabling.

Part Number	Std. Pkg. Qty.	Part Number	Std. Pkg. Qty.	Colors
-------------	----------------	-------------	----------------	--------

11 ft. lengths		13 ft. lengths		
----------------	--	----------------	--	--

**PAN-POLE Communication Only Pole**

PCPA11IW	1	PCPA13IW	1	Off White
PCPA11EI	1	PCPA13EI	1	Elec. Ivory

**PAN-POLE** Pole Assembly is supplied in 11 and 13 foot lengths for maximum ceiling heights of 10 or 12 feet.

Standard furnished factory assembled pole configuration include the following:

1. Aluminum extruded base with blank plastic cover

Standard furnished mounting hardware includes:

6. Entry end bend radius fitting for communication cabling (two mounting screws included)
7. Ceiling T-bar bracket (two mounting screws included)
8. Two (2) ceiling tile trim plates
9. End cap with two pre-drilled holes
10. End cap floor grip pad

Data hardware sold separately

**ORDERING INFORMATION:**

Order number of **PAN-POLE** Aluminum Outlet Poles required.

## PAN-POLE Accessories



T70SDB-X

Part Number	Description	Colors	Std. Pkg. Qty.	Std. Ctn. Qty.
<b>Standard Faceplate Bracket (for Data)</b>				
T70SDB-X	Used to mount NEMA standard single gang screw-on communication faceplates (not for use with snap-on faceplates).	Gray ONLY	1 pc.	10 pcs.

**ORDERING INFORMATION:**

Order number of pieces required, in multiples of Standard Package Quantity.

## Standard Included Mounting Hardware



Ceiling T-bar bracket attaches **PAN-POLE** to drop ceiling T-bar (supplied with two thumb screws).



Entry End Bend Radius Control Fitting protects the integrity of communication cabling (supplied with two mounting screws).



Two ceiling tile trim plates provide an aesthetically pleasing appearance.



End Cap Fitting with pre-drilled screw holes provides sturdy base (screws not included).



End cap with supplied adhesive backed grip pad applied provides sturdy base for easy-to-move carpet mount applications.

**2**

**Installing PAN-WAY™ Snap-On Faceplates into the PAN-POLE™ Aluminum Outlet Pole**



Remove cover from Power and Communication or Communication Only Pole.



Cut cover to desired size.



Terminate jacks and snap into module frame.



Screw module frame and faceplate together.



Snap faceplate to channel.



Finished product.

**3**

**Installing Standard Screw-On Communication Faceplates into the PAN-POLE™ Aluminum Outlet Pole**



Remove cover from Power and Communication or Communication Only Pole.



Cut cover to desired size.



Snap-On standard faceplate bracket.



Terminate jacks, snap jacks into module frame and screw module frame to faceplate bracket.



Install faceplate over module frame.



Finished product.

**4**

**Installing U.S. Standard Screw-On Communication Faceplates into the PAN-POLE™ Aluminum Outlet Pole**



Remove cover from Power and Communication or Communication Only Pole.



Cut cover to desired size.



Snap-On standard faceplate bracket.



Terminate jacks and snap jacks into faceplate.



Install faceplate over bracket.



Finished product.



## Fill Capacities for PAN-POLE™ Aluminum Outlet Poles

Use the wirefill configurations below along with the wirefill information contained on the next two pages as a guide in selecting the proper size raceway. The maximum amounts may vary according to the wire installation methods, straightness of wires, etc.

### PAN-POLE Power and Communication Pole

FILL CAPACITIES

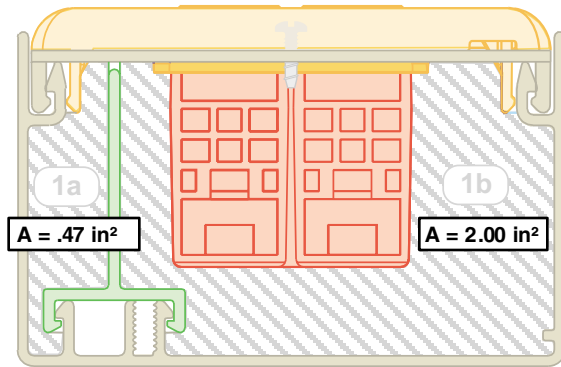

**Wirefill #1: Data using Snap-On Communication Faceplates (with screw holes to mount a module frame)**

*Includes: Snap-On Communication Faceplate (with screw holes to mount a module frame), Standard Communication Module Frame and Communication Modules.*

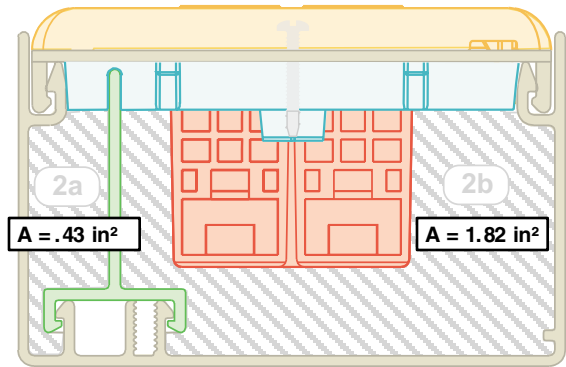

**Wirefill #2: Data using U.S. Standard Screw-On Communication Faceplate and Standard Faceplate Bracket**

*Includes: U.S. Standard Screw-On Communication Faceplate, Standard Faceplate Bracket, Sloped Insert, and Communication Modules*

### PAN-POLE Communication Only Pole

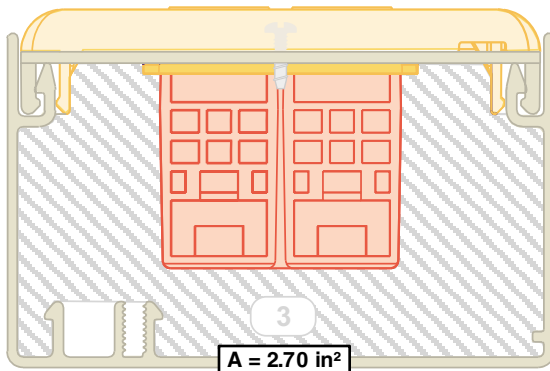

**Wirefill #3: Data using Snap-On Communication Faceplates (with screw holes to mount a module frame)**

*Includes: Snap-On Communication Faceplate (with screw holes to mount a module frame), Standard Communication Module Frame and Communication Modules.*

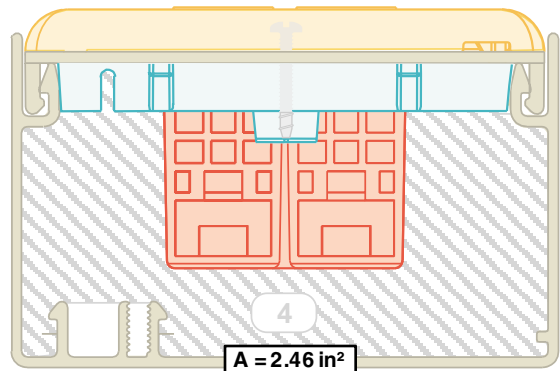

**Wirefill #4: Data using U.S. Standard Screw-On Communication Faceplate and Standard Faceplate Bracket**

*Includes: U.S. Standard Screw-On Communication Faceplate, Standard Faceplate Bracket, Sloped Insert, and Communication Modules*

**Fill Capacities for PAN-POLE™ Aluminum Outlet Poles**

This information is to be used as a guide in selecting the proper configuration. The maximum amounts may vary according to the wire installation methods, straightness of wires, etc.

**SPEC=40% wirefill**—the recommended design in cable capacity. Leaves room for future moves, adds and changes

**MAX=60% wirefill**—the maximum cable quantity based on minimal cable interweaving and ideal packing factors (Electrical fill capacity based on UL temperature rise testing)

FILL CAPACITIES

**Fill Capacity Table for:**

- Electrical
- Voice Grade 24 AWG UTP
- Data Grade 24 AWG UTP

Pole Channel Configurations	Electrical Cables	Voice Grade Cables						Data Grade Cables				
	AWG	24 AWG UTP CM/CMR										
	12	2 pr		3 pr		4 pr		25 pr		Cat. 5 4 pr		
		DIA.= 0.120		DIA.= 0.150		DIA.= 0.190		DIA.=0.422		DIA.=0.217		
	0.122	FILL		FILL		FILL		FILL		FILL		
MAX	SPEC	MAX	SPEC	MAX	SPEC	MAX	SPEC	MAX	SPEC	MAX	SPEC	MAX
1a <b>PAN-POLE</b> Power & Communications Pole	11	**	**	**	**	**	**	**	**	**	**	**
1b <b>PAN-POLE</b> Power & Communications Pole	**	70	106	45	67	200	42	5	8	21	32	
2a <b>PAN-POLE</b> Power & Communications Pole	11	**	**	**	**	**	**	**	**	**	**	**
2b <b>PAN-POLE</b> Power & Communications Pole	**	64	96	41	61	25	38	5	7	19	29	
3 <b>PAN-POLE</b> Communications Only Pole	**	95	142	60	91	37	56	7	11	29	43	
4 <b>PAN-POLE</b> Communications Only Pole	**	87	130	55	83	34	51	7	10	26	39	

NOTE: See [page xiv-xv](#) for further explanation of wirefill data.  
 \*\* Not power configuration

**Fill Capacity Table for:**

- Data Grade 22 AWG UTP
- Data Grade 24, 22 AWG STP
- 1A STP

Pole Channel Configurations	Data Grade Cables														
	24 AWG STP CM				22 AWG UTP CM				22 AWG STP CM				1A 22 AWG STP CM		
	25 pr		4 pr		25 pr		4 pr		25 pr		4 pr				
	DIA.=0.512		DIA.=0.250		DIA.= 0.544		DIA.= 0.234		DIA.=0.635		DIA.=0.286		DIA.=0.430		
	FILL		FILL		FILL		FILL		FILL		FILL		FILL		
SPEC	MAX	SPEC	MAX	SPEC	MAX	SPEC	MAX	SPEC	MAX	SPEC	MAX	SPEC	MAX	SPEC	MAX
1a <b>PAN-POLE</b> Power & Communications Pole	**	**	**	**	**	**	**	**	**	**	**	**	**	**	**
1b <b>PAN-POLE</b> Power & Communications Pole	3	5	16	24	3	5	18	27	2	3	12	18	5	8	
2a <b>PAN-POLE</b> Power & Communications Pole	**	**	**	**	**	**	**	**	**	**	**	**	**	**	
2b <b>PAN-POLE</b> Power & Communications Pole	3	5	14	22	3	4	25	37	2	3	11	16	5	7	
3 <b>PAN-POLE</b> Communications Only Pole	5	7	21	32	4	6	22	34	3	5	16	25	7	11	
4 <b>PAN-POLE</b> Communications Only Pole	4	7	20	30	4	6	22	34	3	4	15	22	6	10	

NOTE: See [page xiv-xv](#) for further explanation of wirefill data.  
 \*\* Not power configuration

## Fill Capacities for PAN-POLE™ Aluminum Outlet Pole

This information is to be used as a guide in selecting the proper configuration. The maximum amounts may vary according to the wire installation methods, straightness of wires, etc.

**SPEC=40% wirefill**—the recommended design in cable capacity. Leaves room for future moves, adds and changes

**MAX=60% wirefill**—the maximum cable quantity based on minimal cable interweaving and ideal packing factors (Electrical fill capacity based on UL temperature rise testing)

### Fill Capacity Table for: •Coax Cables

Pole Channel Configurations		Coax Cables									
		RG6/u		RG11/u		RG58/u		RG59/u		RG62A/u	
		DIA.=0.270		DIA.=0.405		DIA.=0.193		DIA.=0.242		DIA.=0.242	
		FILL		FILL		FILL		FILL		FILL	
		SPEC	MAX	SPEC	MAX	SPEC	MAX	SPEC	MAX	SPEC	MAX
1a	<b>PAN-POLE</b> Power & Communication Pole	**	**	**	**	**	**	**	**	**	**
1b	<b>PAN-POLE</b> Power & Communication Pole	13	20	6	9	27	40	17	25	17	25
2a	<b>PAN-POLE</b> Power & Communication Pole	**	**	**	**	**	**	**	**	**	**
2b	<b>PAN-POLE</b> Power & Communication Pole	12	19	5	8	24	37	15	23	15	23
3	<b>PAN-POLE</b> Communication Only Pole	18	28	8	12	36	55	23	35	23	35
4	<b>PAN-POLE</b> Communication Only Pole	17	25	7	11	33	50	21	32	21	32

NOTE: See [page xiv-xv](#) for further explanation of wirefill data.  
\*\* Not power configuration

### Fill Capacity Table for: •Fiber Optic Cable (62.5/125mm) •Signal Cables

Pole Channel Configurations		Fiber Optic Cables (62.5/125mm)					
		2 Strand		4 Strand		6 Strand	
		DIA.=0.175		DIA.=0.175		DIA.=0.210	
		FILL		FILL		FILL	
		SPEC	MAX	SPEC	MAX	SPEC	MAX
1a	<b>PAN-POLE</b> Power & Communication Pole	**	**	**	**	**	**
1b	<b>PAN-POLE</b> Power & Communication Pole	33	49	33	49	23	34
2a	<b>PAN-POLE</b> Power & Communication Pole	**	**	**	**	**	**
2b	<b>PAN-POLE</b> Power & Communication Pole	30	45	30	45	20	31
3	<b>PAN-POLE</b> Communication Only Pole	44	67	44	67	31	46
4	<b>PAN-POLE</b> Communication Only Pole	40	61	40	61	28	42

NOTE: See [page xiv-xv](#) for further explanation of wirefill data.  
\*\* Not power configuration

108  
01033

# ***Telecommunication Equipment Room Products***



## **FIBER-DUCT™ Routing System**

NEC Compliant/UL Listed

The **FIBER-DUCT** Routing System provides a complete solution for routing and protecting your fiber optic cables. This system can also be used for Category 5, UTP, ScTP, and Coax cabling applications as well. The fittings are designed to maintain a minimum 2" cable bend radius which protects against signal loss due to excessive bending of cables. A full selection of fittings is available to speed the installation.

### **Additional features include:**

#### **UL Listed for general use**

- UL94V-0 Flammability rating on all PVC fittings and PVC duct
- Snap on non-slip covers
- Two sizes: 2" X 2" and 4" X 4"
- Minimum 2" bend radius fittings
- Available in Orange, Light Gray, Black and Yellow (Duct—PVC; Fittings—ABS material)
- Available in clear (Polycarbonate material)
- Manufactured in an ISO 9001 registered facility

#### **Excellent for use in:**

- Telecommunications Closets
- Central Offices
- Equipment rooms
- Entrance facilities
- Appropriate floor and ceiling spaces



Panduit **FIBER-DUCT™** Routing System provides the following key benefits:

#### **Compliant with NEC Articles 770 & 800**

- Protects against signal loss due to excessive bending
- Easy and secure installation—completely enclosed to protect cables
- Allows for distribution of large amounts of fiber cable
- Identifies Fiber Optic Cable (Orange = Multi-mode; Yellow = Single-Mode)
- Provides a totally integrated cabling solution
- ISO 9001 assures highest quality and reliability

**Table of Contents**

Page



**FIBER-DUCT™ Routing System**

Fittings . . . . . J3-J4  
Mounting Brackets . . . . . J4-J5

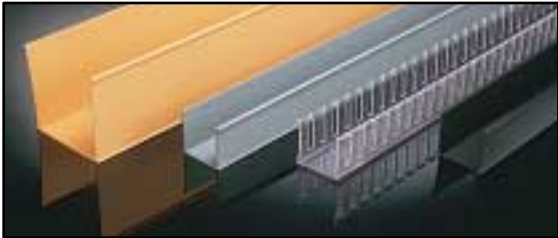

**PANDUCT® Types E and S**

Fiber Duct . . . . . J3

Fill Capacity Information . . . . . J6

**FIBER-DUCT Routing System Applications**



**FIBER-DUCT** Routing System can be used with a cable management system when routing fiber optic or category 5 cables to telecommunications racks or enclosures.

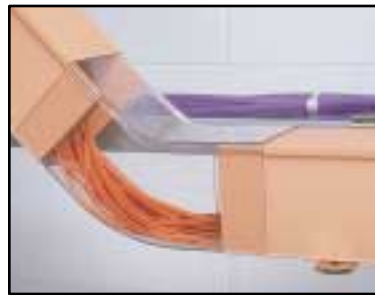

Both duct and fittings are available in clear for low smoke applications. The clear polycarbonate material allows cable color to show through for easy identification.



Both duct and fittings are available in orange (multi-mode) and yellow (single-mode) to clearly identify fiber optic cable.



All fittings in this system are designed with a minimum 2" bend radius to protect fiber optic cables. **FIBER-DUCT** System includes a complete line of mounting hardware for a variety of applications.

## PANDUCT® Solid and Slotted Wall Wiring Duct



Duct Part Number	Nominal Duct Size		Cover Part Number	Color ♦	Material	Std. Length	Duct Std. Ctn. Qty.	Cover Std. Ctn. Qty.
	Width (in)	Height (in)						

### Types S and PS Solid Wall Wiring Duct

S2X2OR6NM	2.00	2.00	C2OR6	Orange	PVC	6 ft	120 ft	120 ft
PS2X2CL6NM	(50.8mm)	(50.8mm)	PC2CL6	Clear	Polycarbonate	6 ft	120 ft	120 ft
S4X4OR6NM	4.00	4.00	C4OR6	Orange	PVC	6 ft	120 ft	120 ft
PS4X4CL6NM	(101.6mm)	(101.6mm)	PC4CL6	Clear	Polycarbonate	6 ft	120 ft	120 ft

NOTE: Available with mounting holes. To order delete NM from the Part Number.



### Types E and PE Slotted Wall Wiring Duct

E2X2OR6	2.00	2.00	C2OR6	Orange	PVC	6 ft	120 ft	120 ft
PE2X2CL6	(50.8mm)	(50.8mm)	PC2CL6	Clear	Polycarbonate	6 ft	120 ft	120 ft
E4X4OR6	4.00	4.00	C4OR6	Orange	PVC	6 ft	120 ft	120 ft
PE4X4CL6	(101.6mm)	(101.6mm)	PC4CL6	Clear	Polycarbonate	6 ft	120 ft	120 ft

NOTE: Available without mounting holes. To order add NM to the end of the Part Number.

♦ PVC material parts listed in Orange (OR) color. To order other colors in PVC material substitute Yellow (YL), BL (Black), and Light Gray (LG). Contact Factory for details.

#### ORDERING INFORMATION:

Order number of feet required, in multiples of Standard Length Increment.

## FIBER-DUCT™ System Fittings



FCF2X2  
FCF4X4

FEC2X2  
FEC4X4



FFWC2X2  
FFWC4X4

FIVRA2X2  
FIVRA4X4



FOVRA2X2  
FOVRA4X4

FIV452X2  
FIV454X4



FOV452X2  
FOV454X4

Part Number	Description	Material	Color ♦	Std. Pkg. Qty.	Std. Ctn. Qty.
FCF2X2OR	Coupler Fitting — 2 x 2 Size	ABS	Orange	1 pc.	5 pcs.
PFCF2X2CL	Used to join two sections of duct together	Polycarbonate	Clear	1 pc.	5 pcs.
FCF4X4OR	Coupler Fitting — 4 x 4 Size	ABS	Orange	1 pc.	5 pcs.
PFCF4X4CL	Used to join two sections of duct together	Polycarbonate	Clear	1 pc.	5 pcs.
FEC2X2OR	End Cap Fitting — 2 x 2 Size	ABS	Orange	1 pc.	5 pcs.
PFEC2X2CL	Closes the end of the duct	Polycarbonate	Clear	1 pc.	5 pcs.
FEC4X4OR	End Cap Fitting — 4 x 4 Size	ABS	Orange	1 pc.	5 pcs.
PFEC4X4CL	Closes the end of the duct	Polycarbonate	Clear	1 pc.	5 pcs.
FFWC2X2OR	Four Way Cross Fitting — 2 x 2 Size	ABS	Orange	1 pc.	5 pcs.
PFFWC2X2CL	Used to join duct at four way cross intersections	Polycarbonate	Clear	1 pc.	5 pcs.
FFWC4X4OR	Four Way Cross Fitting — 4 x 4 Size	ABS	Orange	1 pc.	5 pcs.
PFFWC4X4CL	Used to join duct at four way cross intersections	Polycarbonate	Clear	1 pc.	5 pcs.
FIVRA2X2OR	Inside Vertical Right Angle Fitting — 2 x 2 Size	ABS	Orange	1 pc.	5 pcs.
PFIVRA2X2CL	Used to join duct at 90° inside corners	Polycarbonate	Clear	1 pc.	5 pcs.
FIVRA4X4OR	Inside Vertical Right Angle Fitting — 4 x 4 Size	ABS	Orange	1 pc.	5 pcs.
PFIVRA4X4CL	Used to join duct at 90° inside corners	Polycarbonate	Clear	1 pc.	5 pcs.
FOVRA2X2OR	Outside Vertical Right Angle Fitting — 2 x 2 Size	ABS	Orange	1 pc.	5 pcs.
PFOVRA2X2CL	Used to join duct at 90° outside corners	Polycarbonate	Clear	1 pc.	5 pcs.
FOVRA4X4OR	Outside Vertical Right Angle Fitting — 4 x 4 Size	ABS	Orange	1 pc.	5 pcs.
PFOVRA4X4CL	Used to join duct at 90° outside corners	Polycarbonate	Clear	1 pc.	5 pcs.
FIV452X2OR	Inside Vertical 45° Fitting — 2 x 2 Size	ABS	Orange	1 pc.	5 pcs.
PFIV452X2CL	Used to join duct at 45° inside corners	Polycarbonate	Clear	1 pc.	5 pcs.
FIV454X4OR	Inside Vertical 45° Fitting — 4 x 4 Size	ABS	Orange	1 pc.	5 pcs.
PFIV454X4CL	Used to join duct at 45° inside corners	Polycarbonate	Clear	1 pc.	5 pcs.
FOV452X2OR	Outside Vertical 45° Fitting — 2 x 2 Size	ABS	Orange	1 pc.	5 pcs.
PFOV452X2CL	Used to join duct at 45° outside corners	Polycarbonate	Clear	1 pc.	5 pcs.
FOV454X4OR	Outside Vertical 45° Fitting — 4 x 4 Size	ABS	Orange	1 pc.	5 pcs.
PFOV454X4CL	Used to join duct at 45° outside corners	Polycarbonate	Clear	1 pc.	5 pcs.

♦ ABS material parts listed in Orange (OR) color. To order other colors in ABS material substitute Yellow (YL), BL (Black), and Light Gray (LG). Contact Factory for details.

#### ORDERING INFORMATION:

Order number of pieces required, in multiples of Standard Package.

**FIBER-DUCT™ System Fittings (cont.)**



Part Number	Description	Material	Color*	Std. Pkg. Qty.	Std. Ctn. Qty.
FVT2X2OR PFVT2X2CL	Vertical Tee Fitting — 2 x 2 Size Used to join vertical and horizontal sections of duct	ABS Polycarbonate	Orange Clear	1 pc. 1 pc.	5 pcs. 5 pcs.
FVT4X4OR PFVT4X4CL	Vertical Tee Fitting — 4 x 4 Size Used to join vertical and horizontal sections of duct	ABS Polycarbonate	Orange Clear	1 pc. 1 pc.	5 pcs. 5 pcs.
FRA2X2OR PFRA2X2CL	Right Angle Fitting — 2 x 2 Size Used to join duct at 90° flat junctions	ABS Polycarbonate	Orange Clear	1 pc. 1 pc.	5 pcs. 5 pcs.
FRA4X4OR PFRA4X4CL	Right Angle Fitting — 4 x 4 Size Used to join duct at 90° flat junctions	ABS Polycarbonate	Orange Clear	1 pc. 1 pc.	5 pcs. 5 pcs.
FT2X2OR PFT2X2CL	Tee Fitting — 2 x 2 Size Used to join duct at tee intersections	ABS Polycarbonate	Orange Clear	1 pc. 1 pc.	5 pcs. 5 pcs.
FT4X4OR PFT4X4CL	Tee Fitting — 4 x 4 size Used to join duct at tee intersections	ABS Polycarbonate	Orange Clear	1 pc. 1 pc.	5 pcs. 5 pcs.
FRF42OR PFRF42CL	Reduces 4 x 4 size duct to 2 x 2 size.	ABS Polycarbonate	Orange Clear	1 pc. 1 pc.	5 pcs. 5 pcs.

\* ABS material parts listed in Orange (OR) color. To order other colors in ABS material substitute Yellow (YL), BL (Black), and Light Gray (LG). Contact Factory for details.

**ORDERING INFORMATION:**

Order number of pieces required, in multiples of Standard Package.

**FIBER-DUCT™ Innerduct Transition Fittings**

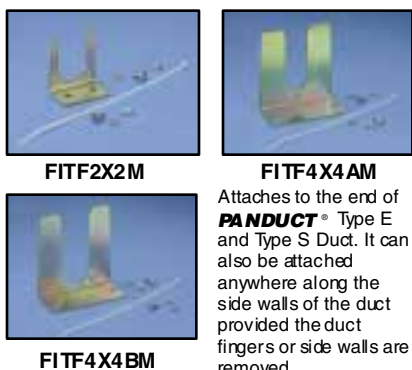

Attaches to the end of **PANDUCT**® Type E and Type S Duct. It can also be attached anywhere along the side walls of the duct provided the duct fingers or side walls are removed.

Part Number	Description	Material	Std. Pkg. Qty.	Std. Ctn. Qty.
<b>Innerduct Transition Fitting – 2 x 2 Size</b>				
FITF2X2	Provides transition from 2 x 2 duct to 3/4" to 1" innerduct.	Metal**	1 pc.	10 pcs.
<b>Innerduct Transition Fitting – 4 x 4 Size</b>				
FITF4X4A	Transition from 4 x 4 duct to 1-2 pcs. 1" innerduct.	Metal**	1 pc.	10 pcs.
FITF4X4B	Transition from 4 x 4 duct to 1-2 pcs. 1 1/4" innerduct.	Metal**	1 pc.	10 pcs.

\*\* Commercial grade cold rolled steel with zinc chromate finish.

**ORDERING INFORMATION:**

Order number of pieces required, in multiples of Standard Package.

**FIBER-DUCT™ Mounting Brackets**



Part Number	Description	Std. Pkg. Qty.	Std. Ctn. Qty.
FTRB12	Bracket attaches to UNISTRUT® Metal Framing. Accepts 1/2" threaded rod (not included). Contains bracket and hardware for attaching to metal framing.	1 pc.	10 pcs.
FTRBE12	Bracket attaches to existing 1/2" threaded rod (not included). Contains bracket and hardware for attaching to threaded rods.	1 pc.	10 pcs.
FTRBE58	Bracket attaches to existing 5/8" threaded rod (not included). Contains bracket and hardware for attaching to threaded rods.	1 pc.	10 pcs.
FTRBN12	Bracket attaches to new 1/2" threaded rod (not included). Contains bracket and hardware for attaching to threaded rods.	1 pc.	10 pcs.
FTRBN58	Bracket attaches to new 5/8" threaded rod (not included). Contains bracket and hardware for attaching to threaded rods.	1 pc.	10 pcs.
FLRB	Bracket attaches to 3/8" X 1-1/2" or 3/8" X 2" ladder rack rails. Contains hardware for attaching bracket to ladder rack. Also contains hardware for attaching duct/fittings to bracket.	1 pc.	10 pcs.

UNISTRUT® is a registered trademark of UNISTRUT Corporation

**ORDERING INFORMATION:**

Order number of pieces required, in multiples of Standard Package.

For Technical Assistance, call: 888-506-5400, Ext. 8287 (outside the U.S., see inside back cover for International Directory)



## FIBER-DUCT™ Mounting Brackets (cont.)



FZBA1.5X4

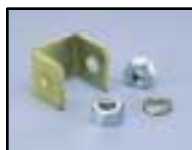

FLB12X15  
FLB12X20  
FLB58X15  
FLB58X20



FUSB



FLB



FMRB

Part Number	Description	Std. Pkg. Qty.	Std. Ctn. Qty.
FZBA1.5X4	Aluminum bracket used to offset duct from mounting surface, adjustable from 1½" to 4".	1 pc.	10 pcs.
FLB12X15	Bracket attaches to 1-1/2" ladder rack rail. Bracket accepts 1/2" threaded rod (not included). Contains bracket and hardware for attaching bracket to ladder rack.	1 pc.	10 pcs.
FLB12X20	Bracket attaches to 2" ladder rack rail. Bracket accepts 1/2" threaded rod (not included). Contains bracket and hardware for attaching bracket to ladder rack.	1 pc.	10 pcs.
FLB58X15	Bracket attaches to 1-1/2" ladder rack rail. Bracket accepts 5/8" threaded rod (not included). Contains bracket and hardware for attaching bracket to ladder rack.	1 pc.	10 pcs.
FLB58X20	Bracket attaches to 2" ladder rack rail. Bracket accepts 5/8" threaded rod (not included). Contains bracket and hardware for attaching bracket to ladder rack.	1 pc.	10 pcs.
FUSB	Bracket attaches to under-floor support pedestal (not included). Contains bracket and hardware for attaching bracket to pedestal. Also contains hardware for attaching duct/fittings to "L" Bracket.	1 pc.	10 pcs.
FLB	"L" Bracket attaches to walls. User supplies appropriate mounting hardware for attaching "L" Bracket to walls. Contains bracket and hardware for attaching duct/fittings to "L" Bracket.	1 pc.	10 pcs.
FMRB	"L" Bracket attaches to top rail of rack for added support. Contains bracket and hardware for attaching "L" Bracket to rack and bracket to duct.	1 pc.	10 pcs.

**ORDERING INFORMATION:**  
Order number of pieces required, in multiples of Standard Package.

## FIBER-DUCT™ Accessories



Part Number	Description	Std. Pkg. Qty.	Std. Ctn. Qty.
NR2WH-L	Optional snap rivet fastens duct and fittings together for added strength and rigidity. Fastener mounts flush to duct surfaces. 2" X 2" rivet white color.	50 pcs.	500 pcs.
NR4BL-L	Optional snap rivet fastens duct and fitting together for added strength and rigidity. Fastener mounts flush to duct surfaces. 4" X 4" rivet black color.	50 pcs.	500 pcs.

**ORDERING INFORMATION:**  
Order number of pieces required, in multiples of Standard Package.

## Fiber Optic Adhesive Markers



- Durable markers available in pressure sensitive card
- Legend: Black
- Background: Orange

Part Number	Legend	Part Number	Legend	Marker Size W X L In. (mm)	Markers Per Card	Std. Pkg. Qty.
-------------	--------	-------------	--------	----------------------------	------------------	----------------

### Adhesive Marker Cards

PCV-FOA	Fiber Optic	PCV-FOCA	Fiber Optic Cable	9.00 X 2.25 (228.6 X 57.2)	1	5 Cards
PCV-FOB	Fiber Optic	PCV-FOCB	Fiber Optic Cable	4.50 X 1.19 (114.3 X 28.6)	4	
PCV-FOC	Fiber Optic	PCV-FOCC	Fiber Optic Cable	2.25 X 0.50 (57.1 X 12.7)	18	

**ORDERING INFORMATION:**  
Order number of pieces required, in multiples of Standard Package.

**Fill Capacities for *PANDUCT*® Type E or Type S**

This information is to be used as a guide in selecting the proper size duct. The maximum amounts may vary according to the wire installation methods, straightness of wires, etc.

**SPEC=40% wirefill**—the recommended design in cable capacity. Leaves room for future moves, adds and changes

**MAX=60% wirefill**—the maximum cable quantity based on cable interweaving and packing factors or UL temperature rise test for electrical

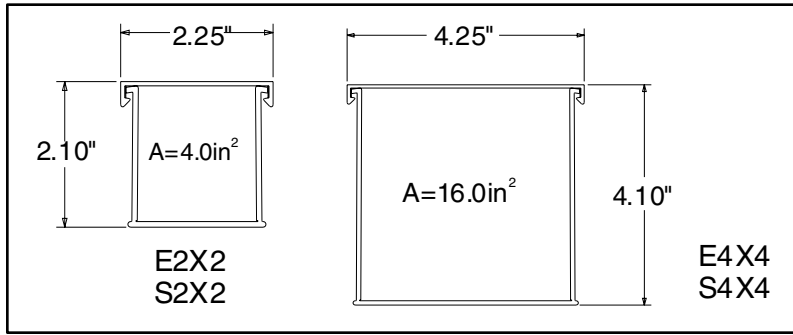

**Fill Capacity Table for:**  
 ·Fiber Optic Cable (62.5/125mm) ·Data Grade 24 AWG UTP

Duct Type	Size	Fiber Optic Cables (62.5/125mm)												Data Grade Cables					
		2 Strand		4 Strand		6 Strand		12 Strand		24 Strand		36 Strand		72 Strand		24 AWG UTP CM			
		DIA.=0.24		DIA.=0.26		DIA.=0.27		DIA.=0.34		DIA.=0.55		DIA.=0.67		DIA.=0.89		25 pr.	Cat.5 4 pr.		
		DIA=0.422		DIA=0.217		FILL		FILL		FILL		FILL		FILL		FILL	FILL		
		SPEC	MAX	SPEC	MAX	SPEC	MAX	SPEC	MAX	SPEC	MAX	SPEC	MAX	SPEC	MAX	SPEC	MAX	SPEC	MAX
<b>PANDUCT</b> Type E or S	2"X2"	35	53	30	45	28	42	18	26	7	10	5	7	3	4	11	17	43	65
<b>PANDUCT</b> Type E or S	4"X4"	142	212	121	181	112	168	71	106	27	40	18	27	10	15	46	69	173	260

NOTE: See [page xiv-xv](#) for further explanation of the wirefill data.

**Table of Contents**

	Page
<b>New TIA/EIA 569-A Requirements for Surface Raceway . . . . .</b>	<b>xiv-xv</b>
<b>New UL-5A Standard Explanation . . . . .</b>	<b>xvi</b>
<b>CSA 22.2 Standard Explanation . . . . .</b>	<b>xvii</b>
<b>NEC Article 352B Standard Explanation . . . . .</b>	<b>xvii</b>
<b>Mounting Guidelines . . . . .</b>	<b>xviii</b>
<b>Flammability . . . . .</b>	<b>xviii</b>
<b>Material Physical Properties . . . . .</b>	<b>xix</b>
<b>Raceway Typical Specifications . . . . .</b>	<b>xx-xxi</b>

**UL 569-A - Commercial Building Standard for Telecommunications Pathways and Spaces**

The purpose of this standard is to standardize specific design and construction practices (in support of telecommunications media and equipment) within and between commercial buildings. Standards are given for rooms or areas and pathways into and through which telecommunications equipment and media are installed.

The key requirements for surface raceways are as follows:

**Section 4.7 of 569-A** describes perimeter pathways and it is here that surface raceway requirements are found.

Surface raceways are horizontal pathways for the installation of media from the telecommunications closet to the work area.

Section 4.7 perimeter pathways — Key Points Summary:

- Perimeter pathways serve work areas where telecommunication devices can be reached from walls at convenient levels.
- Divided or multichannel raceways may include telecommunication and power cabling and outlets as needed.

4.7.1 also states that perimeter pathways shall comply with clause 10.3.

10.3 Horizontal pathway separation from EMI sources states:

- 1) Co-installation of telecommunications cable and power cable is governed by the applicable electrical code for safety. Article 800-52 of ANSI/NFPA 70 shall be applied, for example:
  - a) separation from power conductors
  - b) separation and barriers within raceway
  - c) separation within outlet boxes or compartments

Article 800-52 requires a physical barrier between power and telecommunication cables. (*Non-metallic divider walls are suitable physical barriers.*) No minimum separation distance is required.

**4.7.2.1 Surface raceway** - Surface raceway consists of base, cover and related fittings that mount directly on walls at appropriate work levels to provide a continuous perimeter pathway. Telecommunication outlets are located along the raceway and may be moved or added after initial installation if desired.

**4.7.2.4 Multi-Channel raceway** - Multichannel raceway provides a perimeter pathway for different systems in combination, such as telecommunication and each channel is maintained for each system throughout the building.

**4.7.3.2 Pathway Sizing** - Currently states that practical raceway capacity for telecommunication cabling ranges from 20-40% depending on cable-bending radius. It further notes that pathway fill is under study. As a participant in that study, Panduit and other surface raceway manufacturers have found that fill capacities of surface raceway can be up to 60% when appropriate bend radius is provided. Factors that affect fill capacity are discussed on the following page:

## UL 569-A - Commercial Building Standard for Telecommunications Pathways and Spaces (cont'd)

TIA/EIA 569-A

Initially one may think...  $\frac{\text{RACEWAY AREA}}{\text{CABLE(S) AREA}} = \text{\# of Cables that fit into the Channel}$

But in reality this is impossible..... Why?

Consider this...



**The Packing Factor**

- Cables placed into the channel leave some unusable area depending on the diameter of the cable and shape of the raceway channel. Commonly referred to as the "packing factor".



- Termination devices placed within the surface raceway also reduce the available internal area within the channel. †
- Add in other real world considerations, such as, interweaved/crossed cables and the usable area becomes even less.

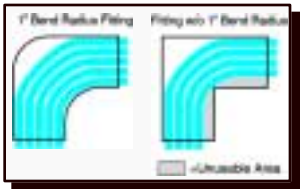

- If the cables being routed require a 1" bend radius and the fittings have a smaller radius even less internal area is available for cables.

### 4.7.3.2 Pathway Sizing (cont'd) -

Anticipated changes to the existing fill capacity suggestions from 569-A have led Panduit to provide the following wirefill quantities for specifying **PAN-WAY™** Surface Raceway Systems:

$$\text{SPEC} = \frac{\text{Raceway Internal Area}}{\text{Cable Area}} \times 40\%$$

$$\text{MAX} = \frac{\text{Raceway Internal Area}}{\text{Cable Area}} \times 60\%$$

**SPEC:** The cable quantity to be used when specifying a new raceway. This quantity leaves room for adding cabling in the future.

**MAX:** The maximum cable quantity that will fit into the raceway (considering factors previously mentioned).<sup>^</sup>

<sup>^</sup>If the bend radius of the cable can not be realized with the fittings of the system this value cannot be attained.

**Example:** Find the SPEC and MAX cable quantities for LDP3 (internal area = .21in<sup>2</sup>) when routing Category 5 UTP cabling (dia = .217")

**1. Determine Cable Area:**

$$\begin{aligned} \text{CABLE AREA} &= \pi r^2 \\ &= (3.14)(.217/2)^2 \\ &= .03695\text{in}^2 \end{aligned}$$

**2. Determine SPEC Quantity:**

$$\begin{aligned} \text{SPEC} &= .21\text{in}^2 / .03695\text{in}^2 \times .40 \\ &= 2.27 \text{ or} \\ &= 2 \text{ Cables} \end{aligned}$$

**3. Determine MAX Quantity:**

$$\begin{aligned} \text{MAX} &= .21\text{in}^2 / .03695\text{in}^2 \times .60 \\ &= 3.40 \text{ or} \\ &= 3 \text{ Cables} \end{aligned}$$

**Note 1:** Per TIA/EIA TR41.8.3 Committee investigations new installations of perimeter raceway systems should be sized using a cable fill based on 40% of the raceway cross-sectional area. A maximum cable fill based on 60% of the raceway cross-sectional area may be attained if the pathway provides the appropriate bend radius for the radius of the cable being routed.

**Note 2:** Power cabling fill capacities of non-metallic raceways are determined by the UL-5A Temperature Test (See UL-5A Brief Explanation on following page.) The MAX value listed in wirefill capacity tables indicates the maximum number of power conductors that can be placed into the raceway channel or indicated channel area.

### 4.7.3.3 Physical Limitations - Use surface raceway in dry locations

### 4.7.3.4 Perimeter raceways should follow the bend radius requirements of the cable. (1" for category 5 UTP)

†Panduit wirefills reference only the usable area for each configuration of each system.

**NOTE:** The information provided above is intended for use only as a guideline. Please refer to the specified document for detailed test descriptions or standards information.



## UL-5A Brief Explanation

### (Standard for Safety of Non-metallic Surface Raceways and Fittings)

The UL Listing mark found on Panduit non-metallic surface raceway systems assures that the raceway components have been evaluated in accordance with the UL-5A standard. Our systems meet or exceed the requirements of **ALL** (not just some) of the tests outlined within UL-5A. This assures the end user of a quality product which will perform in a safe manner when installed as recommended.

#### A product bearing UL-5A listing complies with tests that include the following:

- Utilizes a UL RECOGNIZED material which meets specific UL property requirements. (such as volume resistivity, hot wire ignition, high current ARC ignition, dielectric strength and heat deflection temperature.)
- FLAMMABILITY: The system material has a flammability rating of 94V-0. The finished part has a flammability rating of 94-5VA. Both the raceway and associated fittings will not ignite combustible materials in its vicinity or support a flame longer than 60 seconds following the final test flame application.
- LOW TEMPERATURE HANDLING AT -32°C: This test assures that the raceway integrity will remain intact under typical conditions encountered during shipment and handling in a hostile subzero temperature.
- COLD TEMPERATURE IMPACT AT 0°C: A 1.18 lb. steel sphere is dropped from a height of 51 inches to produce an impact of 5 ft./lbs. This test simulates the impact resistance of the product when subjected to a cold temperature extreme following installation, such as cold storage or an area without heat.
- CRUSHING: Both the raceway and fittings are subjected to a compressive load of 300 lbs. which is maintained for one minute. This load is twice the average weight of an average person. Following the removal of the load, both the raceway and fittings remain intact and show no signs of permanent deformation.
- TEST FOR MOLD STRESS: During the cooling process stresses may be frozen in the raceway or fitting. This test conditions the product in an air circulating oven for seven (7) hours at the maximum intended useful temperature of the system. After cooling to room temperature the raceway system with cover remains intact and secure.
- TEMPERATURE TEST: The raceway undergoes a four (4) hour test to determine the safe number of ELECTRICAL conductors with which to operate the system. This assures the end user that the POWER conductor and raceway will not exceed their respective temperature rating during their intended operation.
- TRIAL INSTALLATION: This is conducted to verify that the recommended installation instructions and MOUNTING HARDWARE are effective and that the system maintains a complete and safe enclosure of conductors.
- RECEPTACLE SECURENESS: Assures that a receptacle shall remain secure in the raceway when a power cord attachment plug is inserted and a 25 lb. weight is applied for 60 seconds. This test is conducted with the receptacle positioned horizontally to the ground and then repeated with receptacle face at a 30° angle to the power cord.
- SECURITY OF KNOCKOUT AND BREAKAWAY TAB: A knockout or break-away tab shall remain intact following a force application of 10 lbs. for 60 seconds. Following the removal of the tab no sharp edges shall be left which could cause the removal of the conductor insulation. This test assures that the tab can resist an applied force but can be removed easily per recommended instructions.

NOTE: The information provided above is intended for use only as a guideline. Please refer to the specified document for detailed test descriptions or standards information.



## CSA 22.2 No. 62-93 Brief Explanation (Surface Raceway Systems)

The CSA (Canadian Standards Association) Listing mark found on Panduit non-metallic surface raceway systems assures that the raceway components have been evaluated in accordance with the CSA 22.2 No. 62-93 standard. Our systems meet or exceed the requirements of **ALL** (not just some) of the tests outlined within CSA 22.2. This assures the end user of a quality product which will perform in a safe manner when installed as recommended.

*These tests parallel the tests outlined on the previous page for UL listing and are not listed here (consult CSA22.2 No. 62-93 for specific test information.)*

## NEC Article 352B Brief Explanation (Non-Metallic Surface Raceways)

*Non-metallic surface raceways are addressed under section 352B of the National Electric Code, please reference this section of the NEC for specific information regarding non-metallic surface raceway.*

352B applies to a type of non-metallic surface raceway and fittings of suitable nonmetallic material that is resistant to moisture and chemical atmospheres. It shall also be flame retardant, resistant to impact and crushing, resistant to distortion from heat under conditions likely to be encountered in service, and resistant to low-temperature effects.

**Section 352B includes the following:**

### 352-22. Use

The use of non-metallic surface raceways shall be permitted in dry locations. They shall not be used where concealed

### 352-26. Combination Raceways.

Where combination non-metallic surface raceways are used both for signaling and for lighting and power circuits, the different systems shall be run in separate compartments, identified by printed legend or by sharply contrasting colors of the interior finish, and the same relative position of compartments shall be maintained throughout the premises.

### 352-27. General.

Non-metallic surface raceways shall be of such construction as will distinguish them from other raceways. Non-metallic surface raceways and their elbows, couplings, and similar fittings shall be so designed that the sections can be mechanically coupled together and installed without subjecting the wires to abrasion.

### 352-28. Extension Through Walls and Floors.

Non-metallic surface raceways shall be permitted to pass transversely through dry walls, dry partitions, and dry floors if the length passing through is unbroken. Access to the conductors shall be maintained on both sides of the wall, partition, or floor.

### 352-29. Splices and Taps.

Splices and taps shall be permitted in non-metallic surface raceways having a removable cover that is accessible after installation. The conductors, including splices and taps, shall not fill the raceway to more than 75 percent of its area at that point. Splices and taps in non-metallic surface raceways without removable covers shall be made only in junction boxes. All splices and taps shall be made by approved methods.

NOTE: The information provided above is intended for use only as a guideline. Please refer to the specified document for detailed test descriptions or standards information.

For Technical Assistance, call: 888-506-5400, Ext. 8287 (outside the U.S., see inside back cover for International Directory)

## Mounting Guidelines

### Low Voltage (Data) Installations

Data only (low voltage <48V) raceway can be mounted with factory applied adhesive backing for permanent or temporary installation. The mounting surface must be smooth and clean for adhesive to work properly. *Caution - Adhesive attachment is permanent!* Removal may cause damage to mounting surface (i.e. may remove paper from drywall etc.).

### Power Installations

Power rated single channel and multi-channel raceway must be mechanically fastened to the mounting surface (screwed onto) as required by the NEC. UL requires the mounting fasteners to be appropriate for mounting surface, meaning use a masonry fastener for attaching to brick; a wood screw for attaching to studs etc.

Fastener heads should be the “panhead” type to reduce the possibility of damaging the cable’s insulation. Fasteners are spaced every 16 inches and within 1½" of each end of the raceway. Panduit instruction sheets provide recommended spacing requirements for specific products.

## Flammability

This test method measures the comparative burning characteristics of solid plastic materials‡.

### UL Vertical Burning Test

Test samples measure 125mm by 13mm by the minimum thickness of the end product. Tests are conducted utilizing unaged samples (as manufactured) and aged samples (7 days @ 70°C, 158°F.) A standard test flame is applied for two 10 second applications to the unsupported end of a vertically clamped sample. The afterflame time is recorded following the first flame application. Both afterflame and afterglow times are recorded following the second flame application. Also observed and documented is if the sample drips flaming particles that ignite the cotton layer below.

### Materials Classed 94V-0 (Criteria)

- Afterflame for each sample does not exceed 10 seconds following the removal of each flame application
- Total afterflame time for a set of five samples following both flame applications is not greater than 50 seconds
- Afterflame plus afterglow time for each sample does not exceed 30 seconds following the second flame application
- A sample does not exhibit afterflame or afterglow up to the holding clamp
- The cotton indicator below the sample does not ignite from flaming particles or droplets from the test sample

‡ This test is conducted under controlled laboratory conditions. It does not represent the material response under actual fire conditions.

**Physical Properties**

PHYSICAL PROPERTIES

PROPERTIES	UNITS	TEST METHOD	PVC	ABS	POLY-STYRENE	ABS/PVC	POLYCARB.
<b>GENERAL</b>							
Specific Gravity	g/cc	ASTM D 792	1.38	1.22	1.18	1.19	1.21
Heat Deflection Temperature @264 psi	°F	ASTM D 648	163	160	185	203	270
Thermal Expansion 10 <sup>-5</sup> in/in/°F	°F	ASTM D 696	3.7	N/A	N/A	3.9	N/A
Thermal Conductivity	°F	ASTM C 177	1.3	N/A	N/A	N/A	N/A
Compressive Yield Strength	psi	ASTM D 695	8,100	N/A	N/A	N/A	12,500
<b>BURNING CHARACTERISTICS</b>							
Flammability Class	—	UL94	V-0	V-0	V-0	V-0	N/A
Smoke Density—ASTM	—	ASTM E 662	538	N/A	N/A	N/A	120
Limited Oxygen Index (LOI)	—	ASTM D 2863	40-49	N/A	N/A	30	37.8
<b>HARDNESS</b>							
Durometer Hardness	“D”	ASTM D 2240	78	N/A	N/A	N/A	N/A
Rockwell Hardness	“R”	ASTM D 785	111	N/A	N/A	122	118
<b>TENSILE</b>							
Strength at Yield	psi	ASTM D 638	6,200	5,800	4,000	8,700	9,000
Modulus	psi	ASTM D 638	390,000	300,000	N/A	380,000	N/A
<b>FLEXURAL</b>							
Strength at Yield	psi	ASTM D 790	11,000	9,500	4,700	13,800	13,200
Modulus	psi	ASTM D 790	350,000	300,000	280,000	390,000	325,000
<b>IMPACT STRENGTH</b>							
Notched Izod (.125") at:		ASTM D 256					
23°C (73°F)	ft-lb/in		17.0	3.0	1.7	14.0	12.0
0°C (32°F)	ft-lb/in		1.6	N/A	N/A	N/A	N/A
-18°C (0°F)	ft-lb/in		1.1	N/A	N/A	N/A	N/A
Unnotched Modified Izod at:		ASTM D 256					
23°C (73°F)	ft-lb/in		64.0+	N/A	N/A	N/A	60.0
0°C (32°F)	ft-lb/in		64.0+	N/A	N/A	N/A	N/A
-18°C (0°F)	ft-lb/in		42.0+	N/A	N/A	N/A	N/A
<b>ELECTRICAL PROPERTIES</b>							
Power Factor:		ASTM D 150					
60 Hz @30°C (86°F)	—		2.90	N/A	N/A	N/A	N/A
1 MHz @30°C (86°F)	—		4.00	N/A	N/A	N/A	N/A
Dielectric Constant:		ASTM D 150					
60 Hz @30°C (86°F)	—		3.90	N/A	N/A	N/A	3.01
1 MHz @30°C (86°F)	—		3.30	N/A	N/A	N/A	2.96
Dielectric Strength:		ASTM D 149					
Normal	volts/mil		690	N/A	N/A	760	425
Moist	volts/mil		700	N/A	N/A	N/A	N/A

NOTE: To the best of our knowledge the above information is accurate, is based upon accepted technical practices and is believed to be reliable. Panduit assumes no liability for the accuracy or completeness of this information.



## Raceway Typical Specifications

### **FIBER-DUCT™** ROUTING SYSTEM:

The **FIBER-DUCT** non-metallic system shall be used to route, protect and conceal fiber optic, Category 5 UTP, ScTP and coaxial cables in communication closets. **FIBER-DUCT** solid and slotted wiring raceways shall have non-slip snap-on covers as well as a full complement of fittings. The system shall be manufactured in yellow, orange, black and gray colors from impact-resistant PVC with a flammability rating of U.L. 94V-0. In addition, a clear polycarbonate version for low smoke/halogen applications shall be available. 2" x 2" and 4" x 4" sizes shall be available along with fittings that have a 2" bend radius and mounting brackets. The **FIBER-DUCT** Raceway finish shall be pure color and will resist scratches and dents and will not peel or corrode.

### **PAN-WAY™** TYPE LDP SURFACE RACEWAY:

Type LDP non-metallic single channel, one-piece tamper resistant latch design, adhesive backed, hinged cover, surface raceway, shall be used to route, protect and conceal data, voice, video, fiber optic or power cabling. The surface raceway shall be listed as suitable for use in applications having up to 600V between conductors by Underwriters Laboratories, Inc. per standard 5A and LDP10 rated up to 300V by Canadian Standards Association per 22.2 No. 62-93, when installed per instructions. The raceway will include a full complement of power bend radius control (BRC), and standard fittings consisting of, but not limited to: elbows (internal and external), couplings for joining raceway sections, blank end fittings for closing open ends of the raceway, entrance fittings, reducer fittings, tee fittings and an optional raceway installation tool. The BRC fittings shall incorporate a minimum 1" bend radius as recommended for Category 5 UTP and fiber optic cables in TIA/EIA 568-A. Type LDP surface raceway will be manufactured in 3 different lengths from impact-resistant material with a flammability rating of UL94V-0. Type LDP Raceway finish shall be pure color and will resist scratches and dents and will not peel or corrode. Type LDP Raceway shall be available in 3 sizes, five standard colors and shall be optimized for use with the **PANDUIT® PAN-NET™** Network Cabling System.

### **PAN-WAY™** LD2P10 SURFACE RACEWAY:

Type LD2P10 non-metallic, two channel, one piece tamper resistant latch design, adhesive backed, hinged cover, surface raceway shall be used to route, protect, and conceal data, voice, fiber optic, and power cabling. The surface raceway shall be listed as suitable for use in applications having up to 600V between conductors by Underwriters Laboratories, Inc. Standard 5A, and rated up to 300V by Canadian Standards Association Standard 22.2 No. 62-93, when screw secured and installed per instructions. The raceway will include a full complement of fittings which maintain a 1" minimum bend radius, compliant with TIA/EIA Standards 568-A, as well as junction boxes which allow termination of both power and communications cabling. Type LD2P10 raceway will be manufactured from impact-resistant material with flammability rating of UL94V-0. Type LD2P10 raceway finish shall be pure color and will resist scratches and dents, and will not peel or corrode. Type LD2P10 raceway shall be available in four standard colors and shall be optimized for use with the **PANDUIT PAN-NET** Network Cabling System.

### **PAN-WAY™** TYPE LD SURFACE RACEWAY:

Type LD non-metallic single channel, a one-piece design, adhesive backed, hinged cover surface raceway, shall be used to route, protect and conceal low voltage data, voice, and video cabling. The raceway will include a full complement of bend radius control (BRC) and standard fittings consisting of, but not limited to: elbows (internal and external), couplings for joining raceway sections, blank end fittings for closing open ends of the raceway, entrance fittings, reducer fittings, and tee fittings. The BRC fittings shall incorporate a minimum 1" bend radius as recommended for Category 5 UTP and fiber optic cables in TIA/EIA 568-A. Type LD raceway will be manufactured in 3 different lengths from impact-resistant material with a flammability rating of UL94V-0. Type LD Raceway finish shall be pure color and will resist scratches and dents and will not peel or corrode. Type LD Raceway shall be available in 3 sizes and five standard colors and shall be optimized for use with the **PANDUIT PAN-NET** Network Cabling System.

### **PAN-WAY™** TYPE LDS SURFACE RACEWAY:

Type LDS non-metallic surface raceway will be a one piece, solid raceway used to route, protect, and conceal data network, voice, or power cabling. The raceway shall be listed as suitable for use in applications having up

## Raceway Typical Specifications (cont'd)

top 600 volts between conductors by Underwriters Laboratories, Inc. per standard 5A when screw secured with mounting straps and per installation instructions. The raceway shall be manufactured from impact resistant material with a flammability rating of UL94V-0. A full complement of power, 1" bend radius control (BRC), and standard snap-on fittings must be available. All fittings and boxes shall be tamper resistant to prevent unauthorized access to cables. Type LDS Raceway finish shall be pure color and will resist scratches and dents and will not peel or corrode. It shall be optimized for use with the **PANDUIT® PAN-NET™** Network Cabling System.

### **PAN-WAY™ TYPE CD SURFACE RACEWAY:**

Type CD non-metallic single channel surface raceway, shall be used to route, protect and conceal low voltage data, voice, and video cabling. The raceway shall be available in 3 sizes and shall include a full complement of bend radius control and standard fittings including, but not limited to: elbows (internal and external), couplings for joining raceway sections, blank end fittings for closing open ends of the raceway, and tee fittings. The BRC fittings shall incorporate a minimum 1" bend radius as recommended for Category 5 UTP and fiber optic cables in TIA/EIA 568-A. The raceway shall consist of an adhesive backed base and separate cover. Screw mounted metal base pieces shall be available to mount the raceway to irregular mounting surfaces and to masonry surfaces. Type CD raceway must be manufactured from impact-resistant material with a flammability rating of UL94V-0. Type CD Raceway finish shall be pure color and will resist scratches and dents and will not peel or corrode. Type CD Raceway shall be available in five standard colors and shall be optimized for use with the **PANDUIT PAN-NET** Network Cabling System.

### **PAN-WAY™ TYPE PD SURFACE RACEWAY:**

Type PD, a two-piece single channel non-metallic surface raceway, shall be used to route, protect and conceal data, voice, video, or power cabling. The surface raceway shall be listed as suitable for use in applications having up to 600V between conductors by Underwriters Laboratories, Inc. per standard 5A and up to 300V by Canadian Standards Association per 22.2 No. 62-93, when screw-secured and installed per instructions. The single-channel raceway shall include a full complement of power rated fittings including, but not limited to: elbows (internal and external), couplings for joining raceway sections, blank end fittings for closing open ends of the raceway, wire retainers, tee fitting and flexible fittings for raceway to raceway applications. The raceway shall consist of an adhesive backed base and cover. Type PD raceway must be tamper-resistant and must be manufactured from impact-resistant material with a flammability rating of UL94V-0. Type PD Raceway finish shall be pure color and will resist scratches and dents and will not peel or corrode. Type PD Raceway shall be available in four standard colors and shall be optimized for use with the **PANDUIT PAN-NET** Network Cabling System.

### **PAN-WAY™ TYPE T-70 SURFACE RACEWAY:**

Type T-70 non-metallic multi-channel capable surface raceway shall be used to route, protect, and conceal data, voice, video, fiber optic and power cabling. The raceway shall be listed as suitable for use in applications up to 600 volts between conductors by Underwriters Laboratories, Inc. per standard 5A, and up to 300 volts by Canadian Standards Association, Inc. per 22.2 no. 62-93, when screw secured and installed per instructions. A full complement of fittings with a 1" minimum bend radius compliant with TIA/EIA 568-A, must be available as well as device brackets and internal junction boxes to install a variety of communication and electrical devices. Divider walls must be available to form separate channels in the multi-channel raceway. "Snap-on" faceplates for data and power terminations shall be available. An offset box shall be available, with versions for "snap-on" as well as "screw mount" faceplates, for mounting the power receptacle outside of the raceway channel. Type T-70 raceway will be manufactured from impact-resistant material with flammability rating of 94V-0. Type T-70 raceway must be tamper resistant yet also allow access for moves, adds and changes. Type T-70 Raceway finish shall be pure color and will resist scratches and dents and will not peel or corrode. Type T-70 Raceway shall be available in four standard colors and shall be optimized for use with the **PANDUIT® PAN-NET™** Network Cabling System.

### **PAN-WAY™ TWIN 70 SURFACE RACEWAY:**

Twin 70 non-metallic, multi-channel surface raceway shall be used to route, protect, and conceal data, voice, fiber optic, and power cabling. The raceway shall be listed as suitable for use in applications up to 600V between

**Raceway Typical Specifications (cont'd)**

conductors by Underwriters Laboratories, Inc. standards 5A, and up to 300V by Canadian Standards Association, Inc. per standard 22.2 no. 62-93, when screw - secured and installed per instructions. A full complement of fittings which maintain a 1" minimum bend radius, compliant with TIA/EIA Standards 568-A, must be available as well as device brackets to install a variety of communication and electrical devices. The raceway shall provide two separate covers to maintain total separation of power and low voltage cabling. "Snap-on" faceplates for data and power terminations shall be available. Twin 70 raceway must be tampered resistant yet also allow access for moves, adds, and changes. Twin 70 shall be manufactured from impact-resistant material with a flammability rating of UL 94V-0. Twin 70 raceway finish shall be pure color and will resist scratches and dents, and will not peel or corrode. Twin 70 raceway shall be available in four standard colors and shall be optimized for use with the **PANDUIT® PAN-NET™** Network Cabling System.

**PAN-WAY™ TYPE T SURFACE RACEWAY**

Type T non-metallic multi-channel surface raceway shall be used to route, protect and conceal power and/or communications cabling. The raceway shall be listed as suitable for use in applications up to 600V between conductors by Underwriters Laboratories, Inc. per standard 5A, and up to 300V by Canadian Standards Association, Inc. per 22.2 No. 62-93, when screw-secured and installed per instructions. A full complement of power rated fittings, must be available as well as device brackets to install a variety of communication and electrical devices. Divider wall must be available to form up to 2 separate channels in the multi-channel raceway. Type T raceway must be tamper-resistant yet also allow access for moves, adds and changes and must be manufactured from impact-resistant material with a flammability rating of U.L. 94V-0. Type T Raceway finish shall be pure color and will resist scratches and dents and will not peel or corrode. Type T Raceway mounting brackets shall be available to mount to irregular mounting surfaces. Type T Raceway shall be available in three sizes and four standard colors and shall be optimized for use with the **PANDUIT PAN-NET** Network Cabling System.

• TYPICAL SPECIFICATIONS

Part Number	Page Number
-------------	-------------

**B**

BA3IW-X.....	E5
BA6IW-X.....	E5

**C**

C2OR6.....	J3
C2OR6.....	J3
C4OR6.....	J3
C4OR6.....	J3
CA3IW-X.....	E5
CA5IW-X.....	E5
CD10IW6.....	C13
CD3IW6.....	C13
CD5IW6.....	C13
CDB106-A.....	C13
CDB10S-A-L.....	C13
CDB36-A.....	C13
CDB3S-A-L.....	C13
CDB56-A.....	C13
CDB5S-A-L.....	C13
CDC10-L.....	C13
CDC5-L.....	C13
CF10IW-X.....	C14
CF3IW-E.....	C14
CF5IW-E.....	C14
CFX10IW-X.....	C14
CFX10IW-X.....	C15
CFX10IW-X.....	C16
CFX3IW-X.....	C14
CFX3IW-X.....	C15
CFX5IW-X.....	C14
CFX5IW-X.....	C15
CP106IW.....	A3
CP106IW-2G.....	A3
CPGIW.....	A3
CPGIW-2G.....	A3

**D**

DCEFXIW-X.....	C14
DCEFXIW-X.....	C15
DCF10IW-X.....	C14
DCF3IW-X.....	C14
DCF5IW-X.....	C14
DJBXAW.....	A6

Part Number	Page Number
-------------	-------------

**E**

E2X2OR6.....	J3
E4X4OR6.....	J3
EBGAW-X.....	A7
ECF10IW-X.....	C14
ECF3IW-E.....	C14
ECF5IW-E.....	C14
ECFX10IW-X.....	C14
ECFX10IW-X.....	C15
ECFX10IW-X.....	C16
ECFX3IW-X.....	C14
ECFX3IW-X.....	C15
ECFX5IW-X.....	C14
ECFX5IW-X.....	C15
EDU20IW-X.....	A4
EEFXIW.....	C16
EGU20IW-X.....	A4
EID16AW-X.....	A6
EIF16AW-X.....	A6
EJA15AW-X.....	A7
EMG13AW-X.....	A7
ERU20IW-X.....	A4
ESD10AW-X.....	A6
ESG16AW-X.....	A7
ETG16AW-X.....	A7
ETU20IW-X.....	A4

**F**

FCF2X2OR.....	J3
FCF4X4OR.....	J3
FCFP1PAW-X.....	A6
FEC2X2OR.....	J3
FEC4X4OR.....	J3
FFWC2X2OR.....	J3
FFWC4X4OR.....	J3
FG1BL50-A.....	H1
FG1BL6-A.....	H1
FG1BR50-A.....	H1
FG1BR6-A.....	H1
FG1EI50-A.....	H1
FG1EI6-A.....	H1
FG1YL50-A.....	H1
FG1YL6-A.....	H1
FG3BL50-A.....	H1

Part Number	Page Number
-------------	-------------

FG3BL6S-A.....	H1
FG3BR50-A.....	H1
FG3BR6S-A.....	H1
FG3EI50-A.....	H1
FG3EI6S-A.....	H1
FG3YL50-A.....	H1
FG3YL6S-A.....	H1
FITF2X2.....	J4
FITF4X4A.....	J4
FITF4X4B.....	J4
FIV452X2OR.....	J3
FIV454X4OR.....	J3
FIVRA2X2OR.....	J3
FIVRA4X4OR.....	J3
FLB.....	J5
FLB12X15.....	J5
FLB12X20.....	J5
FLB58X15.....	J5
FLB58X20.....	J5
FLRB.....	J4
FMRB.....	J5
FMS100X6.....	H1
FMS75X6.....	H1
FOV452X2OR.....	J3
FOV454X4OR.....	J3
FOVRA2X2OR.....	J3
FOVRA4X4OR.....	J3
FP1BIW.....	A5
FP2BBIW.....	A5
FRA2X2OR.....	J4
FRA4X4OR.....	J4
FRF42OR.....	J4
FT2X2OR.....	J4
FT4X4OR.....	J4
FTRB12.....	J4
FTRBE12.....	J4
FTRBE58.....	J4
FTRBN12.....	J4
FTRBN58.....	J4
FUSB.....	J5
FVT2X2OR.....	J4
FVT4X4OR.....	J4
FZBA1.5X4.....	J5

Part Number	Page Number
-------------	-------------

**I**

ICF10IW-X	C14
ICF3IW-E	C14
ICF5IW-E	C14
ICFC10IW-X	C14
ICFC3IW-X	C14
ICFC5IW-X	C14
ICFX10IW-X	C15
ICFX10IW-X	C16
ICFX3IW-X	C15
ICFX5IW-X	C15

**J**

JB1DIW-A	E3
JB1FSIW-A	E3
JB1IW-A	E3
JBA-X	E3
JBD1	E5
JBD2	E5
JBP1DIW	E4
JBP1DIW	E5
JBP1EIW	E4
JBP1I IW	E4
JBP1IW	E4
JBP1MD20IW	A4
JBP1MR20IW	A4
JBP2DIW	E3
JBP2DIW	E4
JBP2DIW	E5
JBP2FSIW	E3
JBP2IW	E3
JBP2IW	E4
JBP2SIW	E5
JBX3510IW-A	E3

**L**

LD10IW10-A	C12
LD10IW6-A	C12
LD10IW8-A	C12
LD2P10IW10-A	C16
LD2P10IW8-A	C16
LD3IW10-A	C12
LD3IW6-A	C12
LD3IW8-A	C12
LD5IW10-A	C12

Part Number	Page Number
-------------	-------------

LD5IW6-A	C12
LD5IW8-A	C12
LDP10IW10-A	C10
LDP10IW8-A	C10
LDP3IW10-A	C10
LDP3IW8-A	C10
LDP5IW10-A	C10
LDP5IW8-A	C10
LDS3IW10-A	C11
LDS5IW10-A	C11
LDW10-V	C10
LDW3-V	C10
LDW5-V	C10
LMD3IW-Q	C11
LMD5IW-Q	C11

**N**

NR2WH-L	J5
NR4BL-L	J5

**O**

OCF10IW-X	C14
OCF3IW-E	C14
OCF5IW-E	C14
OCFC10IW-X	C15
OCFC3IW-X	C15
OCFC5IW-X	C15
OCFX10IW-X	C14
OCFX10IW-X	C16
OCFX3IW-X	C14
OCFX5IW-X	C14

**P**

PC2CL6	J3
PC2CL6	J3
PC4CL6	J3
PC4CL6	J3
PCF3IW-X	D8
PCF6IW-X	D8
PCPA11EI	16
PCPA11IW	16
PCPA11R20EI	16
PCPA11R20IW	16
PCPA13EI	16
PCPA13IW	16
PCPA13R20EI	16

Part Number	Page Number
-------------	-------------

PCPA13R20IW	16
PCV-FOA	J5
PCV-FOB	J5
PCV-FOC	J5
PCV-FOCA	J5
PCV-FOCB	J5
PCV-FOCC	J5
PD3IW10	D7
PD3IW10-A	D7
PD3IW6	D7
PD3IW6-A	D7
PD3IW8	D7
PD3IW8-A	D7
PD6IW10	D7
PD6IW10-A	D7
PD6IW6	D7
PD6IW6-A	D7
PD6IW8	D7
PD6IW8-A	D7
PE2X2CL6	J3
PE4X4CL6	J3
PECF3IW-X	D8
PECF6IW-X	D8
PEEF36IW-X	D8
PFBC36EI18	D8
PFCF2X2CL	J3
PFCF4X4CL	J3
PFEC2X2CL	J3
PFEC4X4CL	J3
PFF36EI18	D8
PFFWC2X2CL	J3
PFFWC4X4CL	J3
PFIV452X2CL	J3
PFIV454X4CL	J3
PFIVRA2X2CL	J3
PFIVRA4X4CL	J3
PFOV452X2CL	J3
PFOV454X4CL	J3
PFOVRA2X2CL	J3
PFOVRA4X4CL	J3
PFRA2X2CL	J4
PFRA4X4CL	J4
PFRF42CL	J4
PFT2X2CL	J4
PFT4X4CL	J4

Part Number	Page Number
PFVT2X2CL.....	J4
PFVT4X4CL.....	J4
PICF3IW-X.....	D8
PICF6IW-X.....	D8
POCF3IW-X.....	D8
POCF6IW-X.....	D8
PRAF3IW-X.....	D8
PRAF6IW-X.....	D8
PRJBX36IW.....	E4
PS2X2CL6NM.....	J3
PS4X4CL6NM.....	J3
PSJBXIW.....	E4
PTF3IW-X.....	D8
PTF6IW-X.....	D8
PWR6-X.....	D8

**R**

RAEFIW-X.....	C14
RAEFIW-X.....	C15
RAF10IW-X.....	C14
RAF3IW-E.....	C14
RAF5IW-E.....	C14
RAFC10IW-X.....	C14
RAFC3IW-X.....	C14
RAFC5IW-X.....	C14
RAFX10IW-X.....	C15
RAFX10IW-X.....	C16
RAFX3IW-X.....	C15
RAFX5IW-X.....	C15
RF10X3IW-X.....	C14
RF10X5IW-X.....	C14
RF5X3IW-E.....	C14
RFX103IW-X.....	C14
RFX103IW-X.....	C15
RFX105IW-X.....	C14
RFX105IW-X.....	C15
RFX53IW-X.....	C14
RFX53IW-X.....	C15
RJBX3510IW.....	E3

**S**

S2X2OR6NM.....	J3
S4X4OR6NM.....	J3
SRT.....	H1

Part Number	Page Number
<b>T</b>	
T130DBD-X.....	G11
T130DB-X.....	G11
T130DMC2IW.....	G11
T130DMCIW.....	G11
T130FFMCIW.....	G12
T130GIW.....	G10
T130K1IW.....	G11
T130K2IW.....	G11
T130LMCIW.....	G12
T130RMC2IW.....	G11
T130RMCIW.....	G11
T130TDMCIW.....	G12
T130TMCIW.....	G12
T130TRMCIW.....	G12
T170GIW.....	G10
T170K1IW.....	G11
T170K2IW.....	G11
T170K3IW.....	G11
T702BCIW-X.....	B16
T702BIW10.....	B15
T702BIW8.....	B15
T702ECIW.....	B16
T702EEIW.....	B16
T702ICIW.....	B16
T702OCIW.....	B16
T702RAIW.....	B16
T702TIW.....	B16
T702TRI.....	B16
T702TRIW.....	B16
T702TRLIW.....	B16
T70BCIW-X.....	B7
T70BIW10.....	B7
T70BIW8.....	B7
T70BL2IW.....	A5
T70CCIW-X.....	B16
T70CCIW-X.....	B7
T70CIW10.....	B15
T70CIW10.....	B7
T70CIW10.....	F6
T70CIW8.....	B15
T70CIW8.....	B7
T70CIW8.....	F6
T70DB-X.....	B20

Part Number	Page Number
T70DB-X.....	F7
T70DW10.....	B15
T70DW10.....	B7
T70DW8.....	B15
T70DW8.....	B7
T70ECIW.....	B7
T70EEIW.....	B8
T70FSB.....	B20
T70GB-X.....	A7
T70HB3-X.....	B20
T70HB-X.....	B20
T70ICIW.....	B7
T70MDB-X.....	A6
T70OCIW.....	B7
T70PBIW.....	A5
T70PGIW.....	A3
T70PGSIW.....	A3
T70PIW.....	A3
T70PMAW-X.....	A6
T70PSIW.....	A3
T70RAIW.....	B7
T70SDB-X.....	I7
T70S-X.....	B20
T70TDB.....	B8
T70TDC.....	B8
T70TDT.....	B8
T70TIW.....	B8
T70TRCIW.....	B8
T70TRI.....	B8
T70TRIW.....	B8
T70UMBWA-X.....	A7
T70WC2IW.....	B8
T70WCIW.....	B8
T70WR-X.....	B20
T70WR-X.....	F7
TB130IW10.....	G9
TB130IW8.....	G9
TB170IW10.....	G9
TB170IW8.....	G9
TB5583-V.....	G10
TBSR-Q.....	G10
TC130IW10.....	G9
TC130IW8.....	G9
TC170IW10.....	G9

Part Number	Page Number
TC170IW8.....	G9
TCFB3070IW-X.....	G10
TCFC130IW-X.....	G10
TD6810.....	G9
TD688.....	G9
TE70BIW10.....	F6
TE70BIW8.....	F6
TE70CCIW-X.....	F6
TE70CFBIW-X.....	F6
TE70DW10.....	F6
TE70DW8.....	F6
TE70HB.....	F7
TE70ICFIW.....	F6
TE70OCBIW.....	F6
TE70OCCIW.....	F6
TE70RAFIW.....	F6
TE70TD.....	F6
TE70TFIW.....	F6
TEC105IW.....	F6
TEC130IW.....	G10
TEC170IW.....	G10
TEE130IW.....	G10
TF10IW-X.....	C14
TF3IW-E.....	C14
TF5IW-E.....	C14
TFC10IW-X.....	C14
TFC3IW-X.....	C14
TFC5IW-X.....	C14
TFX10IW-X.....	C15

Part Number	Page Number
TFX3IW-X.....	C15
TFX5IW-X.....	C15
TFXD10IW-X.....	C16
TIC130IW.....	G10
TIC170IW.....	G10
TMB105-X.....	F7
TMB130-X.....	G9
TMB170-X.....	G9
TOCB130IW.....	G10
TOCB170IW.....	G10
TOCC130IW.....	G10
TOCC170IW.....	G10
TR170X130IW.....	G10
TRA130IW.....	G10
TRA170IW.....	G10
TT130IW.....	G10
TT170IW.....	G10
TWR130-X.....	G9
TWR170-X.....	G9

## W

WPS-20.....	A4
WPS-202.....	A4