

**FLUKE®**

# **525A**

Temperature/Pressure Calibrator

Users Manual

## LIMITED WARRANTY AND LIMITATION OF LIABILITY

Each Fluke product is warranted to be free from defects in material and workmanship under normal use and service. The warranty period is one year and begins on the date of shipment. Parts, product repairs, and services are warranted for 90 days. This warranty extends only to the original buyer or end-user customer of a Fluke authorized reseller, and does not apply to fuses, disposable batteries, or to any product which, in Fluke's opinion, has been misused, altered, neglected, contaminated, or damaged by accident or abnormal conditions of operation or handling. Fluke warrants that software will operate substantially in accordance with its functional specifications for 90 days and that it has been properly recorded on non-defective media. Fluke does not warrant that software will be error free or operate without interruption.

Fluke authorized resellers shall extend this warranty on new and unused products to end-user customers only but have no authority to extend a greater or different warranty on behalf of Fluke. Warranty support is available only if product is purchased through a Fluke authorized sales outlet or Buyer has paid the applicable international price. Fluke reserves the right to invoice Buyer for importation costs of repair/replacement parts when product purchased in one country is submitted for repair in another country.

Fluke's warranty obligation is limited, at Fluke's option, to refund of the purchase price, free of charge repair, or replacement of a defective product which is returned to a Fluke authorized service center within the warranty period.

To obtain warranty service, contact your nearest Fluke authorized service center to obtain return authorization information, then send the product to that service center, with a description of the difficulty, postage and insurance prepaid (FOB Destination). Fluke assumes no risk for damage in transit. Following warranty repair, the product will be returned to Buyer, transportation prepaid (FOB Destination). If Fluke determines that failure was caused by neglect, misuse, contamination, alteration, accident, or abnormal condition of operation or handling, including overvoltage failures caused by use outside the product's specified rating, or normal wear and tear of mechanical components, Fluke will provide an estimate of repair costs and obtain authorization before commencing the work. Following repair, the product will be returned to the Buyer transportation prepaid and the Buyer will be billed for the repair and return transportation charges (FOB Shipping Point).

THIS WARRANTY IS BUYER'S SOLE AND EXCLUSIVE REMEDY AND IS IN LIEU OF ALL OTHER WARRANTIES, EXPRESS OR IMPLIED, INCLUDING BUT NOT LIMITED TO ANY IMPLIED WARRANTY OF MERCHANTABILITY OR FITNESS FOR A PARTICULAR PURPOSE. FLUKE SHALL NOT BE LIABLE FOR ANY SPECIAL, INDIRECT, INCIDENTAL, OR CONSEQUENTIAL DAMAGES OR LOSSES, INCLUDING LOSS OF DATA, ARISING FROM ANY CAUSE OR THEORY.

Since some countries or states do not allow limitation of the term of an implied warranty, or exclusion or limitation of incidental or consequential damages, the limitations and exclusions of this warranty may not apply to every buyer. If any provision of this Warranty is held invalid or unenforceable by a court or other decision-maker of competent jurisdiction, such holding will not affect the validity or enforceability of any other provision.

Fluke Corporation  
P.O. Box 9090  
Everett, WA 98206-9090  
U.S.A.

Fluke Europe B.V.  
P.O. Box 1186  
5602 BD Eindhoven  
The Netherlands

11/99

To register your product online, visit [register.fluke.com](http://register.fluke.com)

# Table of Contents

Chapter	Title	Page
<b>1</b>	<b>Getting Started.....</b>	<b>1-1</b>
	Introduction.....	1-1
	Contacting Fluke.....	1-1
	Standard Equipment.....	1-2
	Options and Accessories.....	1-2
	Safety Information.....	1-2
	Getting Acquainted with the Calibrator.....	1-5
	Input and Output Terminals.....	1-5
	Using the Keys.....	1-6
	Display Error Messages.....	1-10
	Rear Panel View.....	1-11
<b>2</b>	<b>Using Output Mode.....</b>	<b>2-1</b>
	Using Output Mode.....	2-1
	Simulating Temperature Using a Thermocouple.....	2-2
	Simulating Temperature Using Resistance Temperature Detectors (RTDs).....	2-3
	Simulating Custom RTD Coefficients.....	2-4
	Default RTD Coefficients.....	2-5
	Entering Custom Standard Platinum Resistance Thermometer (SPRT) Coefficients.....	2-6
	Output DC Voltage.....	2-7
	Output Resistance.....	2-8
	Output Current.....	2-9
<b>3</b>	<b>Using Input Mode.....</b>	<b>3-1</b>
	Using Input Mode.....	3-1
	Measuring Resistance.....	3-1
	Measuring Temperature Using Thermocouples.....	3-2

Thermocouple Zero Calibration .....	3-4
Measuring Temperature Using Resistance Temperature Detectors (RTDs) .....	3-5
Entering and Using Custom RTDs .....	3-7
Default RTD Coefficients .....	3-8
Entering Custom SPRT Coefficients .....	3-9
Measuring Pressure .....	3-10
<b>4 Remote Operation .....</b>	<b>4-1</b>
Introduction .....	4-1
Setting up the RS-232 Port for Remote Control .....	4-2
RS-232 Port Setup Procedure .....	4-2
Testing the RS-232 Port .....	4-2
RS-232 Interface Overview .....	4-5
Setting up the IEEE-488 Port for Remote Control .....	4-5
IEEE-488 Port Setup Procedure .....	4-7
Testing the IEEE-488 Port .....	4-7
Changing Between Remote and Local Operation .....	4-8
Local State .....	4-8
Local with Lockout State .....	4-8
Remote State .....	4-8
Remote with Lockout State .....	4-9
IEEE-488 Interface Overview .....	4-10
Using Commands .....	4-13
Types of Commands .....	4-14
Device-Dependent Commands .....	4-14
Common Commands .....	4-14
Query Commands .....	4-14
Interface Messages (IEEE-488) .....	4-14
Compound Commands .....	4-17
Overlapped Commands .....	4-17
Sequential Commands .....	4-18
Commands for RS-232 Only .....	4-18
Commands for IEEE-488 Only .....	4-18
Command Syntax .....	4-19
Parameter Syntax Rules .....	4-19
Extra Space or Tab Characters .....	4-20
Terminators .....	4-20
Incoming Character Processing .....	4-21
Response Message Syntax .....	4-21
Checking 525A Status .....	4-23
Serial Poll Status Byte (STB) .....	4-24
Service Request (SRQ) Line .....	4-25
Service Request Enable Register (SRE) .....	4-26

	Programming the STB and SRE .....	4-26
	Event Status Register (ESR) .....	4-26
	Event Status Enable (ESE) Register .....	4-26
	Bit Assignments for the ESR and ESE .....	4-27
	Programming the ESR and ESE.....	4-28
	Output Queue .....	4-28
	Error Queue .....	4-28
	Input Buffer Operation .....	4-28
<b>5</b>	<b>Remote Commands .....</b>	<b>5-1</b>
	Introduction.....	5-1
	Command Summary by Function .....	5-1
	Common Commands.....	5-1
	External Connection Commands.....	5-2
	Output Commands.....	5-3
	Measurement Commands .....	5-3
	RS-232 Port Commands.....	5-3
	Status Commands.....	5-4
	Error Code Listing .....	5-4
	Remote Command Listing .....	5-5
<b>6</b>	<b>Maintaining the Calibrator.....</b>	<b>6-1</b>
	Maintenance.....	6-1
	Cleaning the Calibrator .....	6-1
	Replacing a Line Fuse .....	6-1
	Changing Line Voltage .....	6-2
	Performance Tests.....	6-4
	Required Equipment List .....	6-4
	Testing DC Voltage.....	6-5
	Testing DC Current .....	6-6
	Testing Thermocouple Output.....	6-7
	CJC (cold junction compensation) Calibration.....	6-8
	Testing Thermocouple Input .....	6-9
	Testing Ohms Output .....	6-10
	Testing Ohms Input.....	6-12
	Testing Pressure Modules .....	6-14
	Service Center Calibration or Repair.....	6-15
	Replacement Parts.....	6-16
	Accessories .....	6-18
<b>7</b>	<b>Specifications .....</b>	<b>7-1</b>
	General Specifications .....	7-1
	DC Voltage Specifications, Output.....	7-2
	DC Current Specifications, Output.....	7-3

Resistance Specifications, Output .....	7-3
Resistance Specifications, Input .....	7-3
Thermocouple Specification, Output and Input .....	7-4
RTD and Thermistor Specification, Output .....	7-6
RTD and Thermistor Specification, Input .....	7-8
Pressure Measurement.....	7-10

# List of Tables

<b>Table</b>	<b>Title</b>	<b>Page</b>
1-1.	Summary of Input and Output Functions.....	1-2
1-2.	Symbols Used on the Calibrator .....	1-4
1-3.	Pushbutton Usage Functions.....	1-7
1-4.	Function Keys .....	1-8
1-5.	Display Error Messages .....	1-10
2-1.	Default RTD Coefficients .....	2-5
2-2.	Other Commonly Used RTDs.....	2-5
3-1.	Default RTD Coefficients .....	3-8
3-2.	Other Commonly Used RTDs.....	3-8
4-1.	RS-232 Interface Wiring.....	4-5
4-2.	Operating State Transitions .....	4-9
4-3.	RS-232 Emulation of IEEE-488 Messages.....	4-10
4-4.	IEEE-488 Remote Message Coding .....	4-11
4-5.	IEEE-488 Interface Messages (Received) .....	4-16
4-6.	IEEE-488 Interface Messages (Sent).....	4-17
4-7.	Commands for RS-232 Only .....	4-18
4-8.	Units Accepted in Parameters and Used in Responses .....	4-19
4-9.	Terminator Characters .....	4-20
4-10.	Response Data Types.....	4-22
4-11.	Status Register Summary.....	4-23
6-1.	Replacement Fuses .....	6-2
6-2.	Required Equipment .....	6-4
6-4.	TC Temperatures .....	6-7
6-5.	Ohms Output Ranges .....	6-11
6-6.	Ohms Ratio Table .....	6-13
6-7.	Replacement Parts.....	6-17
6-8.	Fluke 700 Series Pressure Modules .....	6-18
6-9.	Fluke 6100 Series Pressure Modules .....	6-19





# List of Figures

Figure	Title	Page
1-1.	Input and Output Terminals and Connectors .....	1-5
1-2.	Pushbuttons.....	1-6
1-3.	Calibrator Function Keys.....	1-8
1-4.	Rear Panel View .....	1-11
2-1.	Connection to Simulate Temperature Using a Thermocouple.....	2-2
2-2.	Connection to Simulate a RTD Temperature.....	2-3
2-3.	Connection for Setting DC Voltage Output.....	2-7
2-4.	Connection for Setting Resistance Output.....	2-8
2-5.	Connection for Setting Current Output.....	2-9
3-1.	Measuring Resistance Using a 4-Wire to 2-Wire Connection .....	3-2
3-2.	Measuring Temperature with a Thermocouple .....	3-3
3-3.	Measuring Temperature Using RTDs.....	3-5
3-4.	Measuring Temperature using an RTD Probe .....	3-6
4-1.	Testing the RS-232 Port.....	4-2
4-2.	Typical RS-232 Remote Control Connections .....	4-4
4-3.	Typical IEEE-488 Remote Control Connections.....	4-6
4-4.	Testing the IEEE-488 Port .....	4-7
4-5.	Status Register Overview.....	4-24
4-6.	Status Byte and SRE Bit Definitions .....	4-25
6-1.	Accessing the Fuse.....	6-3
6-2.	Measuring DC Current.....	6-6
6-3.	Testing TC Output .....	6-7
6-4.	Connections for CJC Calibration .....	6-8
6-5.	Connections for Measuring TC Input .....	6-9
6-6.	Connection for Measuring Resistance Output .....	6-10
6-7.	1281 Connection Diagram .....	6-12
6-8.	Connection for Measuring Ohms.....	6-14
6-9.	Exploded View of the 525A .....	6-16



# Chapter 1

## Getting Started

### **Introduction**

Your Fluke 525A Temperature/Pressure Calibrator (referred to as “the Calibrator”) is an instrument designed to meet the demands of your process tools calibration workload.

In addition to the functions in Table 1-1, the Calibrator has the following features and functions.

- Two line backlit LCD display
- 5-way binding posts
- IEEE 488.2 serial interface (optional)

### **Contacting Fluke**

To order accessories or get the location of the nearest Fluke distributor or Service Center, call:

- USA: 1-888-99-FLUKE (1-888-993-5853)
- Canada: 1-800-36-FLUKE (1-800-363-5853)
- Europe: +31-402-678-200
- Japan: +81-3-3434-0181
- Singapore: +65-738-5655
- Anywhere in the world: +1-425-446-5500

Or, visit Fluke’s Web site at [www.fluke.com](http://www.fluke.com).

To register your product, visit [register.fluke.com](http://register.fluke.com).

Table 1-1. Summary of Input and Output Functions

Function	Input	Output
dc V	None	0 V to 100 V
dc mA	None	0 to 100 mA
Resistance	0 to 4000 $\Omega$	5 to 4000 $\Omega$
Thermocouple	Yes	Yes
RTD	Yes	Yes
Pressure	Yes	No

## Standard Equipment

The items listed below are included with your Calibrator. If the Calibrator is damaged or something is missing, contact the place of purchase immediately. To order replacement parts or spares, see the replacement parts list in Chapter 6.

- 525A *Getting Started Guide*, Part No. 1601541
- 525A CD-ROM (contains the 525A *Users Manual* and 525A *Getting Started Guide*), Part No. 1601552
- Power Cord (120 V cord, Part No.1618621 or 240 V cord, Part No. 769422)
- Thermocouple Shorting Jumper, Part No. 610747

## Options and Accessories

For more information about these accessories and their prices, contact your Fluke representative.

- 5520A – 525A Leads kit
- Y525 Rack Mount kit
- Fluke 700 and 6100 series pressure modules
- MET/CAL with 525A Function Select Code (FSC)
- MET/CAL 525A calibration procedure

## Safety Information

This Calibrator complies with EN 61010, ANSI/ISA-S82.01-1994, CAN/CSA-C22.2 No. 1010.1-92. Use the Calibrator only as specified in this manual, otherwise the protection provided by the Calibrator may be impaired.

CAT II equipment is designed to protect against transients from energy-consuming equipment supplied from the fixed installation, such as TVs, PCs, portable tools, and other household appliances.

A “**⚠ Warning**” statement identifies hazardous conditions and actions that could cause bodily harm or death.

A “**⚠ Caution**” statement identifies conditions and actions that could damage the Calibrator or the equipment under test.











International symbols used on the Calibrator and in this manual are explained in Table 1-2.

### **⚠ Warning**

To avoid possible electric shock or personal injury, follow these guidelines:

- Use the Calibrator only as specified in this manual, or the protection provided by the Calibrator might be impaired.
- Inspect the Calibrator before using it. Do not use the Calibrator if it appears damaged. Look for cracks or missing plastic. Pay particular attention to the insulation around the connectors.
- Have the Calibrator serviced only by qualified service personnel.
- Do not apply more than the rated voltage between the terminals, as marked on the Calibrator, or between any terminal and earth ground.
- Always use the power cord and connector appropriate for the voltage and outlet of the country or location in which you are working.
- Never operate the Calibrator with the cover removed or the case open.
- Never remove the cover or open the case of the Calibrator without first removing the power source.
- Use caution when working with voltages above 30 V ac rms, 42 V ac peak, or 60 V dc. These voltages pose a shock hazard.
- Use only the replacement fuse(s) specified in this manual.
- Use the proper terminals, function, and range for your measurements.
- Do not operate the Calibrator around explosive gas, vapor, or dust.
- When servicing the Calibrator, use only specified replacement parts.

Table 1-2. Symbols Used on the Calibrator

	AC (Alternating Current)		Earth ground
	DC (Direct Current)		Resistance
	Pressure		Conforms to European Union directives
	Chassis protective ground		Canadian Standards Association, NRTL
	Important Information. Refer to the manual.		International ON/OFF symbol.
	Caution, risk of electric shock		

## Getting Acquainted with the Calibrator

### Input and Output Terminals

Figure 1-1 shows the Calibrator input and output terminals and explains their use.

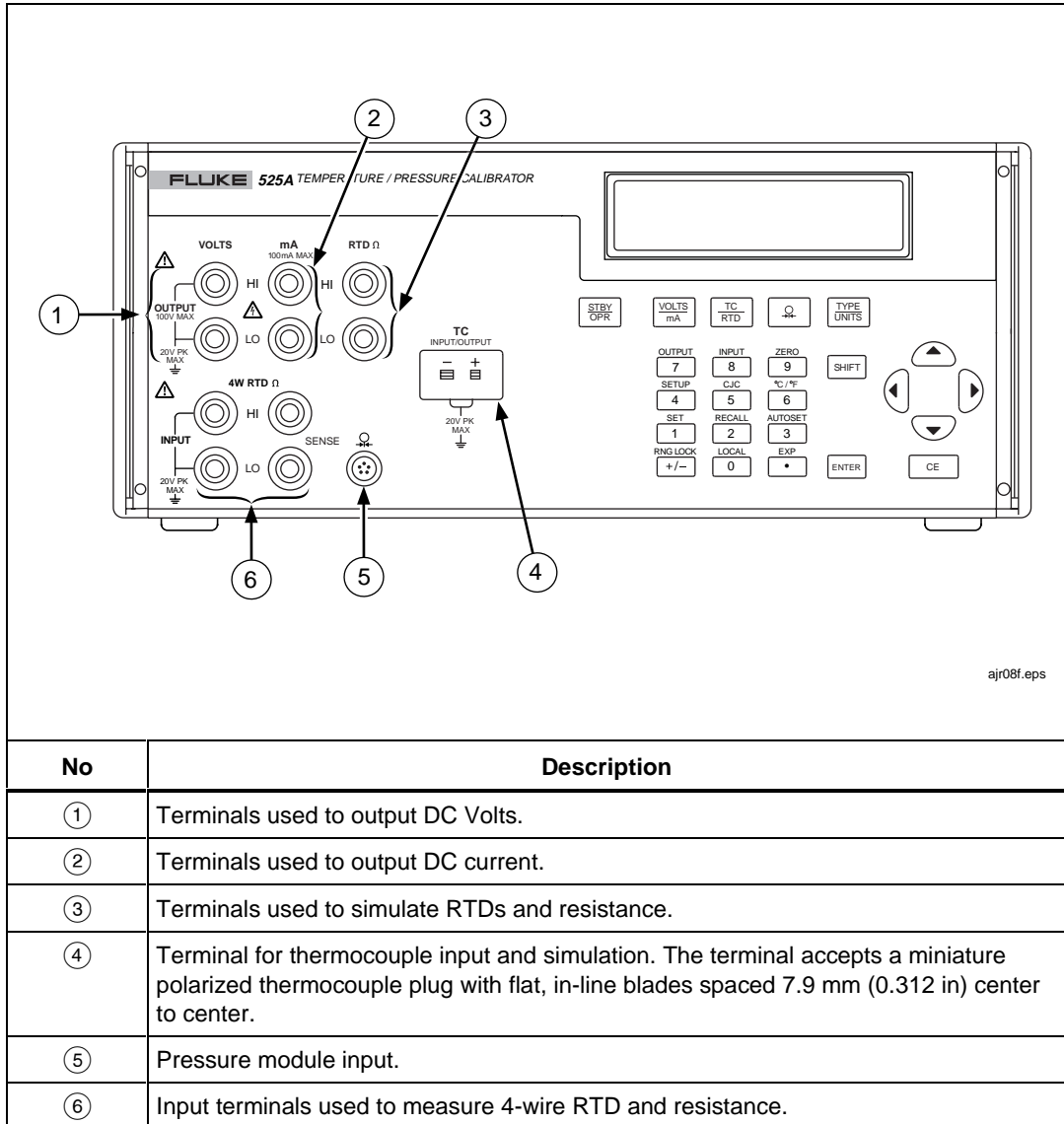

ajr08f.eps

No	Description
①	Terminals used to output DC Volts.
②	Terminals used to output DC current.
③	Terminals used to simulate RTDs and resistance.
④	Terminal for thermocouple input and simulation. The terminal accepts a miniature polarized thermocouple plug with flat, in-line blades spaced 7.9 mm (0.312 in) center to center.
⑤	Pressure module input.
⑥	Input terminals used to measure 4-wire RTD and resistance.

**Figure 1-1. Input and Output Terminals and Connectors**

## Using the Keys

Figure 1-2 shows the Calibrator pushbuttons and Table 1-3 explains their use. Other function keys are shown in Figure 1-3 and described in Table 1-4.

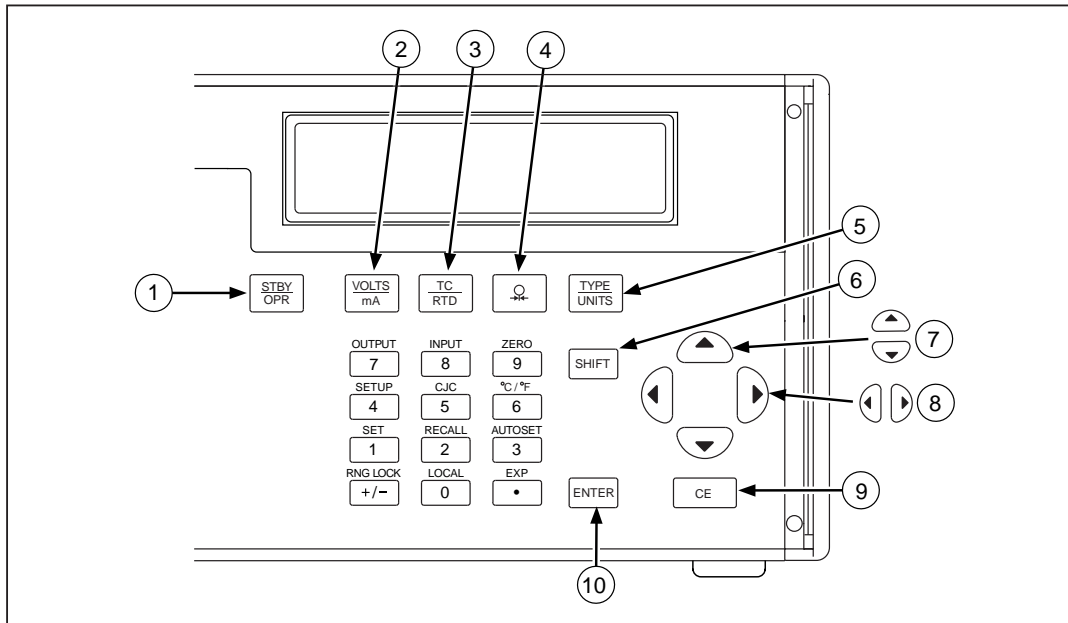











Figure 1-2. Pushbuttons

ajr09f.wmf



Table 1-3. Pushbutton Usage

No	Name	Description
①		Cycles the Calibrator through Standby and Operate modes.
②		Toggles between DC voltage and DC current modes.
③		Toggles between the current thermocouple and current RTD.
④		Selects the pressure measurement mode.
⑤		Selects a thermocouple or RTD type. For pressure measurement, this is used to select the pressure conversion units.
⑥		Selects the alternate function above the numeric keys.
⑦		<ul style="list-style-type: none"> <li>Increases or decreases the output level.</li> <li>Also used to adjust LCD contrast and brightness and to select options on the Interface and Address menus.</li> </ul>
⑧		Selects a different digit to change.
⑨		CE (Clear Entry) clears a partially completed keypad entry from the display. The display reverts to the last known good entry.
⑩		Loads a newly entered output value into the Calibrator. The new value is an entry from the numeric keypad. Also used when entering custom RTD coefficients and when you adjust the display or contrast.

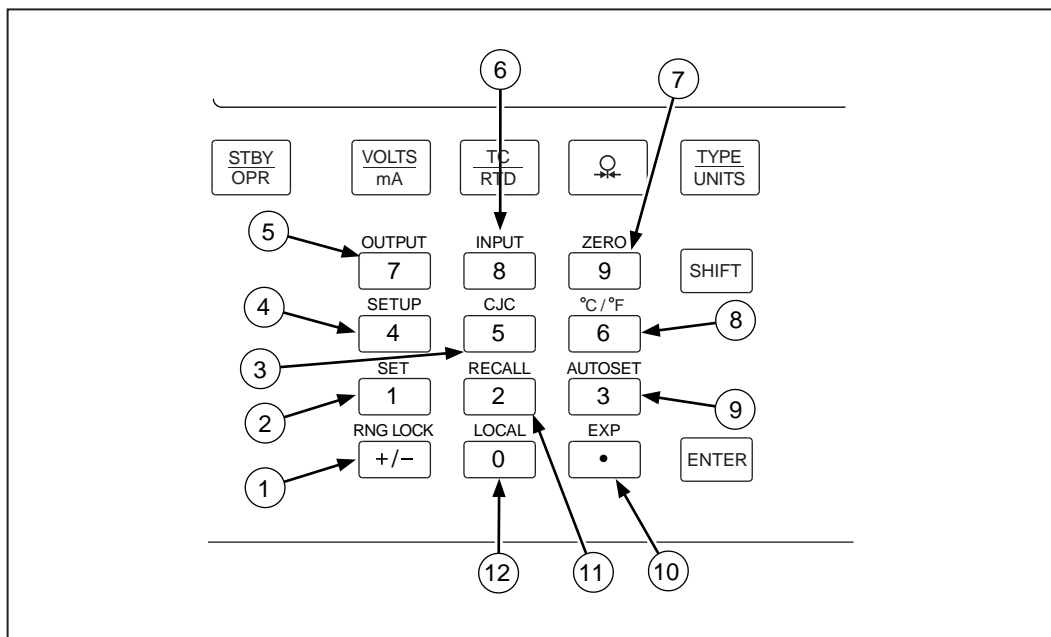









ajr11f.wmf

Figure 1-3. Calibrator Function Keys

Table 1-4. Function Keys

No	Name	Description
①	RNG LOCK +/-	Activates/deactivates the autorange feature of the Calibrator in Voltage source modes.
②	SET 1	Used to program a setpoint step for any output mode.  Key in the desired output and press <b>SHIFT</b> <b>1</b> . SETPOINT # appears on the display. Select a setpoint number from 1 to 9. The output you entered can now be recalled or used in the AUTOSET key described later in this manual.  Each TC type, each RTD/OHMS type, mA, and Volts each have 9 programmable setpoints.
③	CJC 5	Toggles between the internal and external cold junction reference locations.

Table 1-4. Function Keys (cont)

No	Name	Description
④	<p>SETUP</p> <p>4</p>	<p>Press  to advance through the LCD Backlight, Interface, and Address menus.</p> <ul style="list-style-type: none"> <li>Use  and  to adjust LCD backlight when the LCD menu is displayed.</li> <li>Use  and  to toggle between Serial and GPIB interface when the Interface menu is displayed.</li> <li>Use  and  to scroll from Address:1 to Address 30 when the address menu is displayed.</li> </ul>
⑤	<p>OUTPUT</p> <p>7</p>	Selects Output mode.
⑥	<p>INPUT</p> <p>8</p>	Selects Input mode.
⑦	<p>ZERO</p> <p>9</p>	<p>Zeros the pressure module reading when in Pressure Measurement mode.</p> <p>Zeros the thermocouple TC mV/°C offset when in TC Measurement mode.</p>
⑧	<p>°C/°F</p> <p>6</p>	Toggles between Centigrade and Fahrenheit when you are using the TC or RTD functions.
⑨	<p>AUTOSET</p> <p>3</p>	<p>AUTOSET runs through the setpoints you entered using the SET function. Press  . AUTO SET POINT? appears on the display.</p> <p>Enter a number between 1 and 9 that corresponds to the number of setpoints being used. DWELL TIME 5-500? appears on the display. Dwell time is the number of seconds between each setpoint. The output cycles through each setpoint and then reverses the order. For example, if 5 is entered for the number of setpoints, the Calibrator cycles through setpoints 1, 2, 3, 4, 5 and then reverses to setpoints 4, 3, 2, and 1.</p> <p style="text-align: center;"><b>⚠ Caution</b></p> <p style="text-align: center;"><b>Setpoints of 30 V or greater will not go to standby when you use this feature.</b></p>
⑩	<p>EXP</p> <p>.</p>	Used to enter an exponent when you define a custom RTD.

**Table 1-4. Function Keys (cont)**

No	Name	Description
⑪	RECALL <input type="text" value="2"/>	Used to recall a programmed set point.  Press <input type="text" value="SHIFT"/> <input type="text" value="2"/> . RECALL SPT # appears on the display. Enter the number of the output setpoint that you want to use. The output will then be programmed to the setpoint you entered.
⑫	LOCAL <input type="text" value="0"/>	Used to regain local control of the Calibrator. If you set the Calibrator to a remote state using the remote commands, all the front panel keys are locked out except the Local key. When you press the Local key, the front panel is unlocked.  <p style="text-align: center;"><i>Note</i></p> <p><i>This function does not work when you set the Calibrator using the Remote with Lockout command. In Remote with Lockout mode, ALL keys are locked out and the Local key will not unlock the front panel.</i></p>

### Display Error Messages

The following informative messages may appear on the front panel display. An explanation of each message is also provided.

**Table 1-5. Display Error Messages**

Message	Explanation
OVER RANGE	May be displayed in all output modes if you enter a value from the front panel keypad that exceeds the output range of the function.
OVER LOAD	May be displayed in V and mA output modes when the current is exceeded for volts and the resistance is exceeded for mA.
OL	Displayed in Input modes when the measured value exceeds the upper limit of the range.  This error may also display in Output mode when the range is locked and an automatically recalled set point exceeds the locked range. For example, set point 1 (SP1) is set to 1V, SP2 is set to 2V, and SP3 is set to 100V, the range is locked to 10V range and the Calibrator is set up to automatically output the first 3 setpoints. When the Calibrator reaches SP3, the display reads OL, and the output is set to 0 for the duration of that setpoint.
-OL	Displayed in Input modes when the measured value exceeds the lower limit of the range.
INITIALIZATION FAILURE	Displayed when the Calibrator fails to power up properly.

## Rear Panel View

Figure 1-4 shows the features on the rear panel of the Calibrator and explains their use.

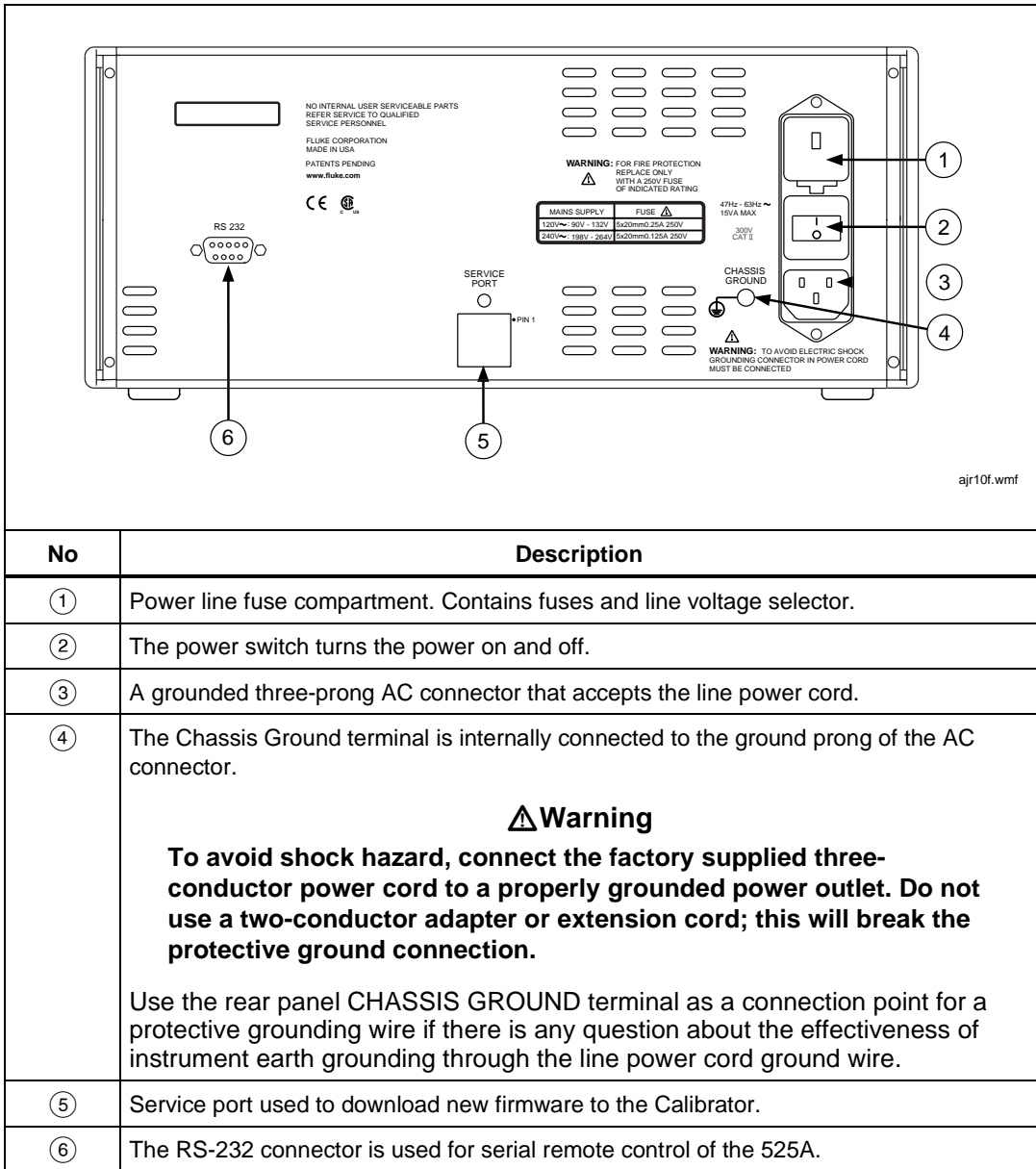

Figure 1-4. Rear Panel View



# Chapter 2

## Using Output Mode



### Using Output Mode

In Output mode, the Calibrator generates calibrated signals for testing and calibrating process instruments. In Output mode, the Calibrator:

- supplies voltage, current, and resistance
- simulates the output of RTD and TC temperature sensors

#### *Note*

*The OVER RANGE message displays if you enter an invalid output using the keypad. If you enter an out-of-range value, the Calibrator reverts to the last known good value. You do not need to press .*

*When adjusting an output using the   keys, the Calibrator will not display or let you enter an out-of-range value.*









#### *Note*

*The figures in this chapter show how to connect to a Fluke 725 Multifunction Process Calibrator. For other instruments, refer to the users manual for connection instructions.*

## Simulating Temperature Using a Thermocouple

Connect the Calibrator TC input/output to the unit under test (UUT) with thermocouple wire and the appropriate thermocouple mini-connector. Supported TC types are listed in Chapter 7. Figure 2-1 shows this connection.

### To simulate temperature using a thermocouple (TC)

1. Attach the thermocouple as shown in Figure 2-1. One pin is wider than the other. Do not try to force a miniplug in the wrong polarization.
2. Press  until TC is selected.
3. If necessary, press   for TC OUT mode.
4. Press  to select the desired thermocouple type.
5. Use the numeric keypad to enter the desired output value and press . You can also adjust the output value by pressing  . Press   to select a different digit to modify.

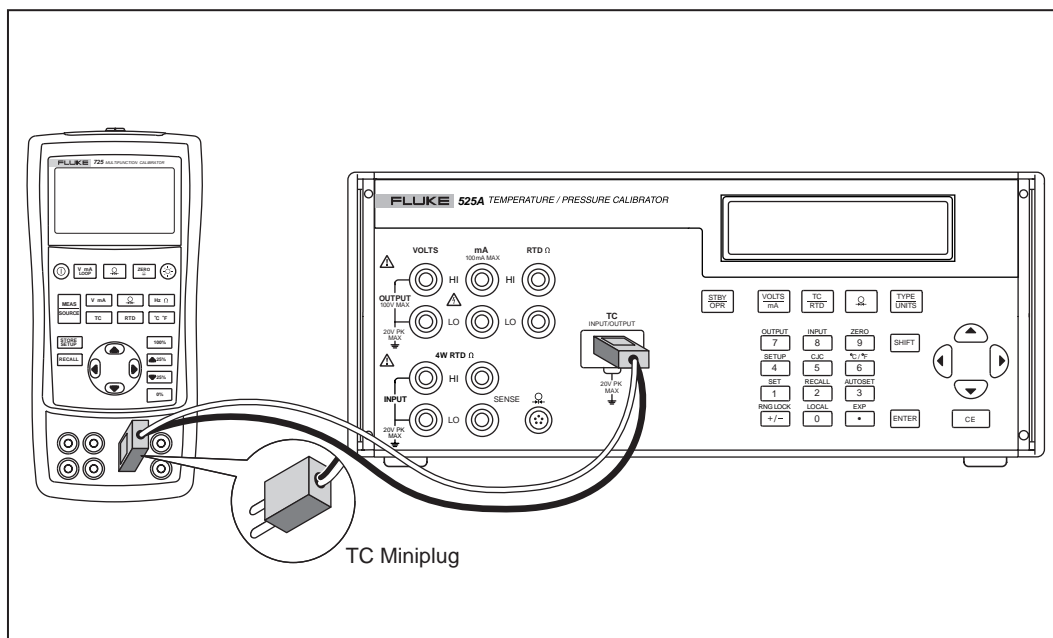

Figure 2-1. Connection to Simulate Temperature Using a Thermocouple

ajr07f.eps



## Simulating Temperature Using Resistance Temperature Detectors (RTDs)

RTDs have a characteristic resistance at specific temperatures. The simulated output, then, is a resistance value based on the selected temperature and type of RTD being simulated.

### To simulate temperature using a resistance temperature detector

1. Connect the Calibrator to the unit under test (UUT) as shown in Figure 2-2.
2. Press **TC/RTD** until RTD is selected.
3. If necessary, press **SHIFT** **7** for RTD OUT mode.
4. Press **TYPE UNITS** to select the desired RTD type.
5. Use the numeric keypad to enter the desired output value and press **ENTER**. You can also adjust the output value by pressing **▲** **▼**. Press **◀** **▶** to select a different digit to modify.
6. Press **STBY/OPR** to activate output.

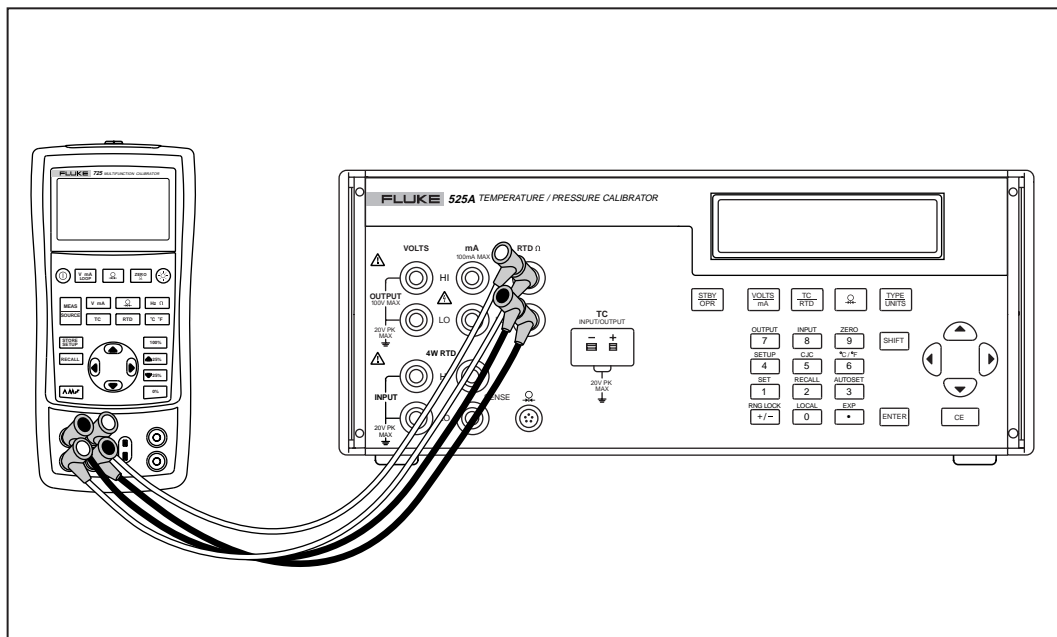

Figure 2-2. Connection to Simulate a RTD temperature

ajr01f.eps

## Simulating Custom RTD Coefficients

The USR\_DEF RTD type allows the Calibrator to simulate a custom curve-fit RTD.

### To enter the coefficients for a custom RTD

1. Press  to select RTD mode.
2. Press  until you get the USR\_DEF display.
3. Press  to enter custom RTD information. RTD CUSTOM (1-5) appears on the Calibrator display. You can store up to five custom RTD definitions on the Calibrator.
4. Press a number key to specify the RTD you want to define (1-5). You can press  to step through definitions without changing the values.
5. When the SET/RECALL display appears, press  to define a custom RTD coefficient.
6. Enter the MIN TEMP and press .
7. Enter the MAX TEMP and press .
8. Enter the nominal resistance ( $R_0$ ) and press .
9. Enter the temperature coefficients and press . Press   to enter a positive or negative exponent for the coefficient.

### To use a custom RTD

1. Press  to enter RTD mode.
2. Press  until you get the USR\_DEF display.
3. Press  to use custom RTD information. RTD CUSTOM (1-5) appears on the Calibrator display. You can store up to five custom RTD definitions on the Calibrator.
4. Press a number key to select the RTD you want to use (1-5).
5. When the SET/RECALL display appears, press  to recall and use the selected RTD.

**Default RTD Coefficients**

The USR\_DEF function of the calibrator uses the Calendar-Van Dusen equation for outputting and measuring custom RTDs. The C coefficient is only used for the subrange -260 to 0 degrees Celsius. Only the A and B coefficients are needed for the subrange 0 to 630 degrees. The R0 is the resistance of the probe at 0 degrees Celsius. All of the USR\_DEF will be set to PT385 as shown in Table 2-1..

**Table 2-1. Default RTD Coefficients**

	Sub range	R <sub>0</sub>	Coefficient A	Coefficient B	Coefficient C
USR_DEF1	0 to 630	100	3.908X10-3	-5.8019X10-7	
USR_DEF2	-260 to 0	100	3.908X10-3	-5.8019X10-7	-5.8019X10-12
USR_DEF3	0 to 630	100	3.908X10-3	-5.8019X10-7	
USR_DEF4	-260 to 0	100	3.908X10-3	-5.8019X10-7	-5.8019X10-12
USR_DEF5	0 to 630	100	3.908X10-3	-5.8019X10-7	

If other types of RTDs are required, Table 2-2 shows the coefficients for types PT391 and PT392. The C coefficient is only used for temperatures below 0 degrees Celsius.

**Table 2-2. Other Commonly Used RTDs**

RTD Type	Coefficient A	Coefficient B	Coefficient C
PT392	3.9848X10-3	-5.87X10-7	-4X10-12
PT391	3.9692X10-3	-5.8495X10-7	-4.2325X10-12









The SPRT 25 ohm function of the calibrator uses ITS-90 standard coefficients for measuring a SPRT. Since the five coefficients are deviations all of them will be set to 0.

*Note*

*The measuring function of the calibrator is limited to 100 ohms, so it can not be used for >100 ohm SPRT.*

## Entering Custom Standard Platinum Resistance Thermometer (SPRT) Coefficients

### To enter coefficients for a custom SPRT

1. Press  to enter RTD mode.
2. Press  until you get the RTD SPRT display and press .
3. Enter the MIN TEMP and press .
4. Enter the MAX TEMP and press .
5. Enter the nominal resistance ( $R_0$ ) and press .
6. Enter the temperature coefficients and press . Press   to enter a positive or negative exponent for the coefficient.

## Output DC Voltage

The Calibrator is a fully programmable precision source of DC voltage from 0 V to 100 V. The Calibrator can only output positive (+) values.

### To output DC voltage

1. Connect the Calibrator to the UUT as shown in Figure 2-3.
2. Press **VOLTS mA** for V out display.
3. Use the numeric keypad to enter the desired output value and press **ENTER**. You can also adjust the output value by pressing **▲ ▼**. Press **◀ ▶** to select a different digit to modify.
4. Press **STBY OFF** to activate output.

### Note

*For safety purposes, the Calibrator resets to standby when output is set to 30 V or greater.*

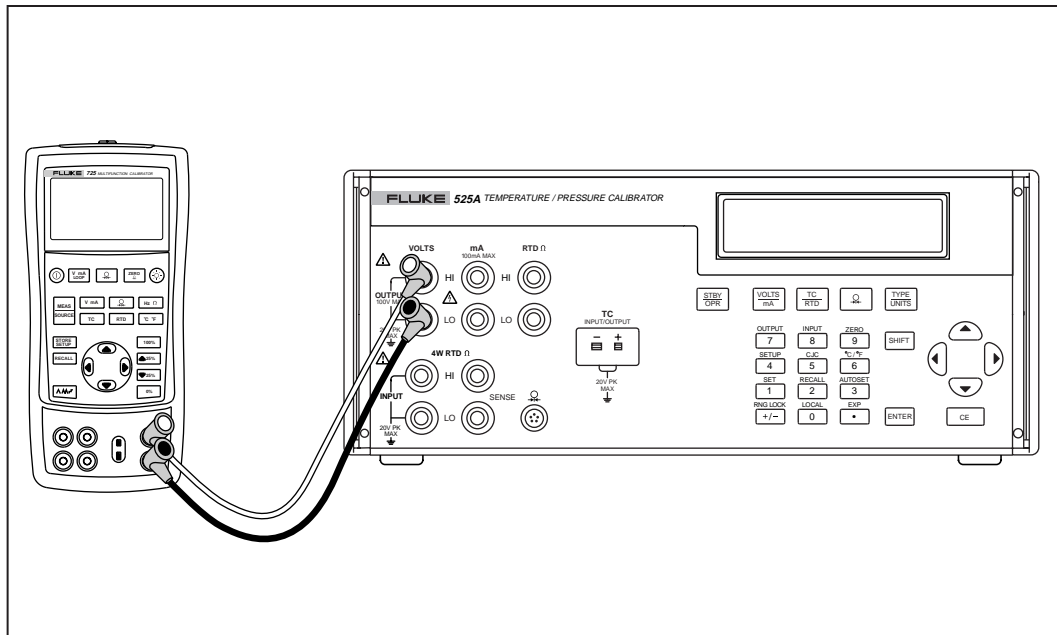

ajr02f.eps

Figure 2-3. Connection for Setting DC Voltage Output

## Output Resistance

### To output resistance

1. Connect the Calibrator to the UUT as shown in Figure 2-4.
2. Press **TC-RTD** until RTD mode is selected.
3. If necessary, press **SHIFT** **7** for RTD OUT mode.
4. Press **TYPE UNITS** to select the appropriate ohms output range (400 or 4000 ohms).
5. Use the numeric keypad to enter the desired output value and press **ENTER**. You can also adjust the output value by pressing **▲** **▼**. Press **◀** **▶** to select a different digit to modify.
6. Press **STBY OPN** to activate output.

### Note

*If the input current is excessive, the Calibrator will beep, display the message OVER LOAD, and enter Standby mode. You will need to check the input current and change it accordingly. Resistance specifications are listed in Chapter 7.*

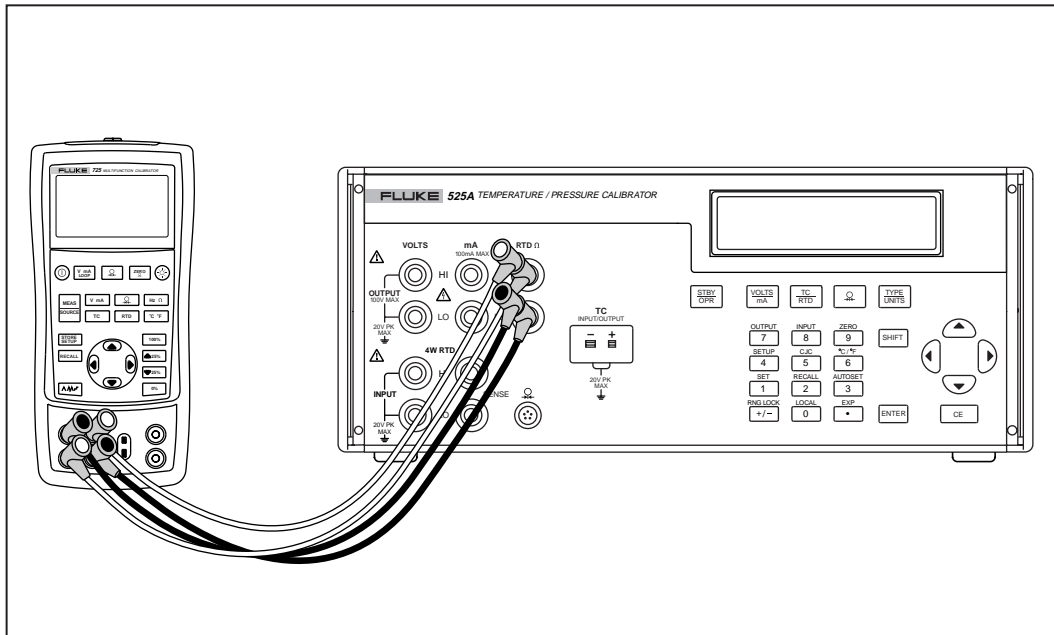

Figure 2-4. Connection for Setting Resistance Output

ajr01f.eps

## Output Current

The Calibrator is a fully programmable precision source of DC current from 0 mA to 100 mA. The Calibrator can only output positive (+) values.

### To output current

1. Connect the Calibrator to the UUT as shown in Figure 2-5.
2. If necessary, press **VOLTS mA** to select mA.
3. Use the numeric keypad to enter the desired output value and press **ENTER**. You can also adjust the output value by pressing **▲ ▼**. Press **◀ ▶** to select a different digit to edit.
4. Press **STBY OFF** activate output.

### Note

*If OVER LOAD appears on the display you may not have a completed circuit loop. When the circuit is complete, the message will disappear.*

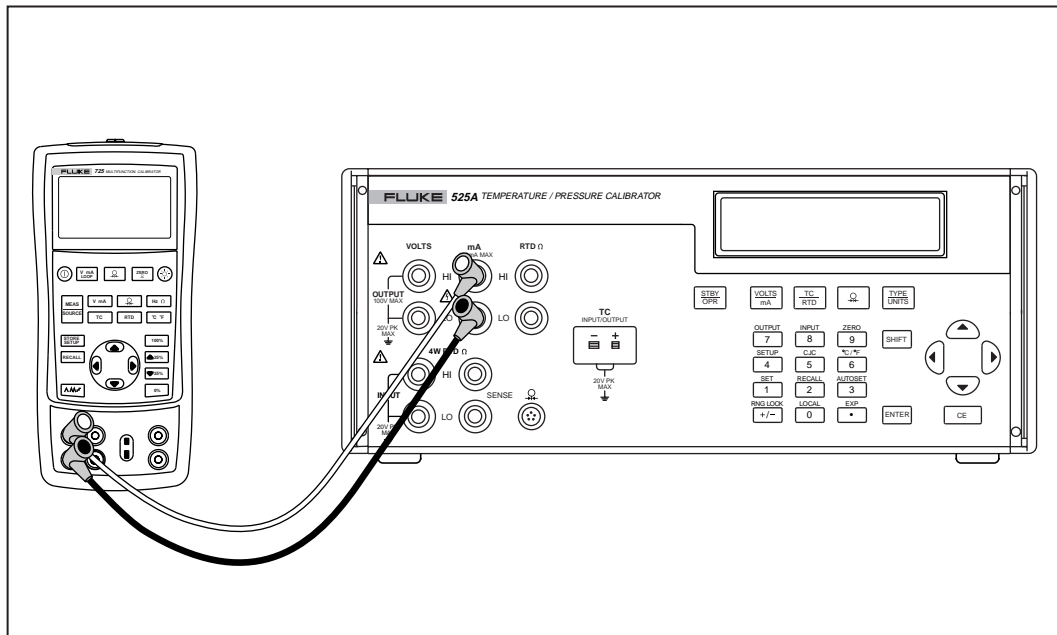

Figure 2-5. Connection for Setting Current Output

ajr03f.eps





# Chapter 3

## Using Input Mode

### Using Input Mode

In Input mode, the Calibrator measures resistance, and temperature from RTD and thermocouple sensors and displays pressure measurements from Fluke 700 and 6100 series pressure modules.





#### Note

*The figures in this chapter show how to connect to a Fluke 725 Multifunction Process Calibrator. For other instruments, refer to the users manual for connection instructions.*

### Measuring Resistance

The Calibrator will only measure resistance using a 4-wire system. The Input terminals supply a fixed DC current and the Sense terminals measure the voltage. When you connect to a 4-wire calibrator, connect the Input to the output terminals and the Sense to the sense terminals for proper measurement.

#### To measure resistance using a 4-wire to 2-wire connection

1. Connect the Calibrator to the instrument you want to test as shown in Figure 3-1.
2. If necessary, press  to select RTD mode.
3. Press  to select an ohms range (400 or 4000 ohms).
4. If necessary, press   for RTD IN mode.

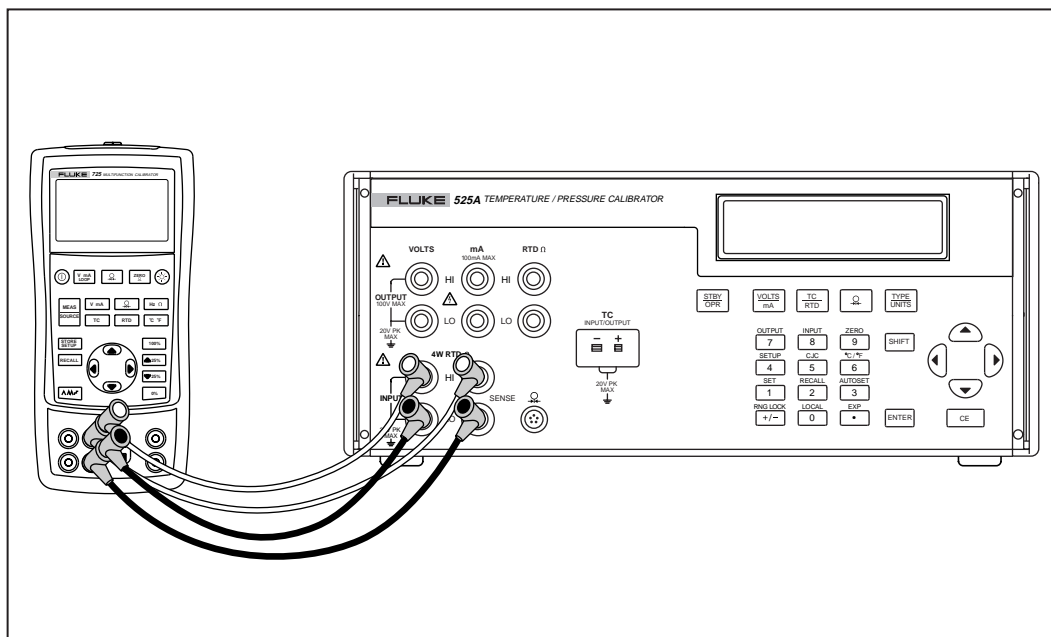

ajr04f.eps

Figure 3-1. Measuring Resistance Using a 4-Wire to 2-Wire Connection

### Measuring Temperature Using Thermocouples

The Calibrator supports numerous standard thermocouples. See Chapter 7 for supported thermocouple specifications.

You can use the **SHIFT** **5** key to toggle the cold junction reference location (CJC) between the internal and external cold junction reference locations. This is used primarily when you want to use an external cold junction for conducting temperature measurements. The **XCJC** status message appears on the display when the Calibrator is in external CJC mode.

**To measure temperature using a thermocouple**

1. Attach the thermocouple leads to the TC input/output connector as shown in Figure 3-2. One pin is wider than the other. Do not attempt to force the plug in the wrong polarization.

*Note*

*If the Calibrator and the TC plug are at different temperatures, wait three minutes or more for the connector temperature to stabilize after you plug the miniplug into the connector.*

2. Press **TC** **RTD** to select TC mode.
3. If necessary, press **SHIFT** **8** to place the Calibrator in TC IN mode.
4. Press **TYPE** **UNITS** to select the desired TC type. You can toggle between °C and °F temperature units by pressing **SHIFT** **6**.

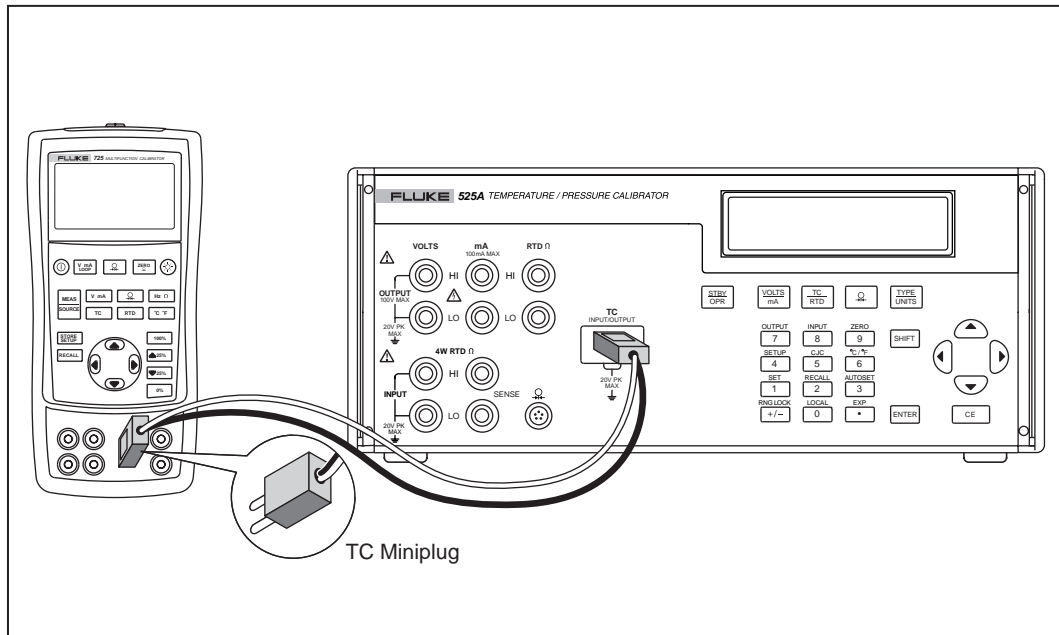

**Figure 3-2. Measuring Temperature with a Thermocouple**

ajr07f.eps

### Thermocouple Zero Calibration

To obtain the optimum measurement accuracy, you must perform a zero calibration when operating the Calibrator outside of the ambient temperature range of 18°C to 28°C. The zero calibration must be performed with the Calibrator thermally stable at the ambient temperature of operation.

#### To perform a thermocouple zero calibration

1. Insert the supplied Thermocouple Shorting Jumper in the TC input/output connector. One pin is wider than the other.
2. Allow time for the connection to become thermally stable.
3. Press  to select TC mode.
4. If necessary, press   to put the Calibrator in TC IN mode.
5. Press  to select mV/°C.
6. If the display does not read 0.000 mV, press   to zero the Calibrator.

#### Note

*Offset values within the range of +/- 1.000 mV can be zeroed out of the measurement.*

## Measuring Temperature Using Resistance Temperature Detectors (RTDs)

You must use a 4-wire connection to achieve the Calibrator accuracy specifications.

### To measure the RTD output from an instrument

1. Connect the Calibrator to the instrument you want to measure as shown in Figure 3-3.
2. Press  $\left[ \begin{array}{c} TC \\ \hline RTD \end{array} \right]$  to select RTD mode.
3. If necessary, press  $\left[ \text{SHIFT} \right]$   $\left[ 8 \right]$  to put the Calibrator in RTD IN mode.
4. Press  $\left[ \begin{array}{c} TYPE \\ \hline UNITS \end{array} \right]$  to select the desired RTD type.

You can toggle between °C and °F temperature units by pressing  $\left[ \text{SHIFT} \right]$   $\left[ 6 \right]$ .

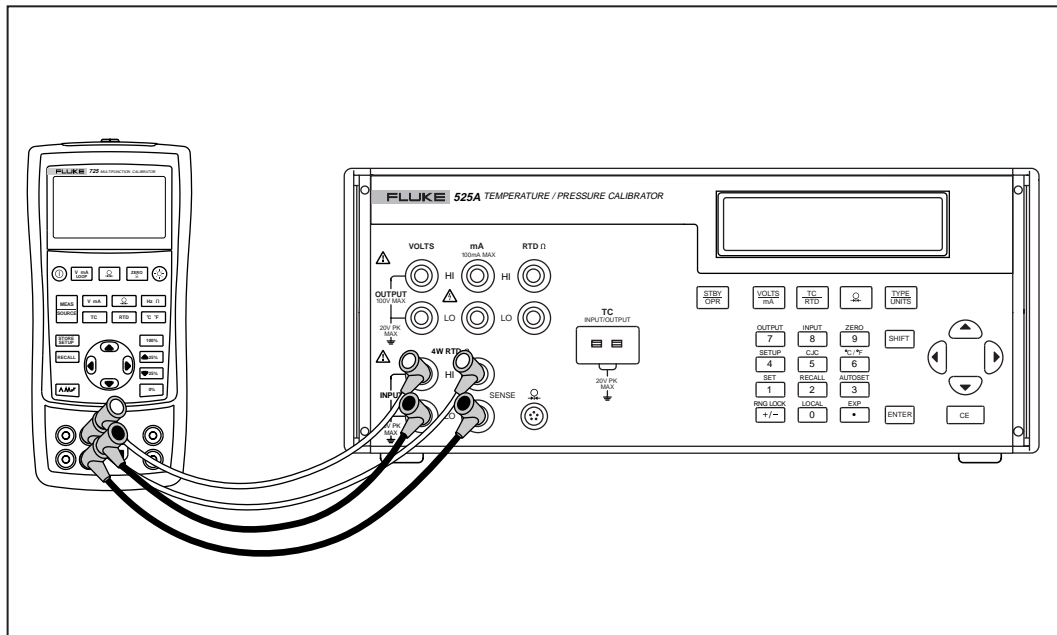

Figure 3-3. Measuring Temperature Using RTDs

ajr06f.wmf

### To measure temperature using an RTD probe

1. Connect an RTD probe to the Calibrator as shown in Figure 3-4.
2. Press **TC** to select the RTD mode.
3. If necessary, press **SHIFT** **8** to put the Calibrator in RTD IN mode.
4. Press **TYPE UNITS** to select the desired RTD type.

You can toggle between °C and °F temperature units by pressing **SHIFT** **6**.

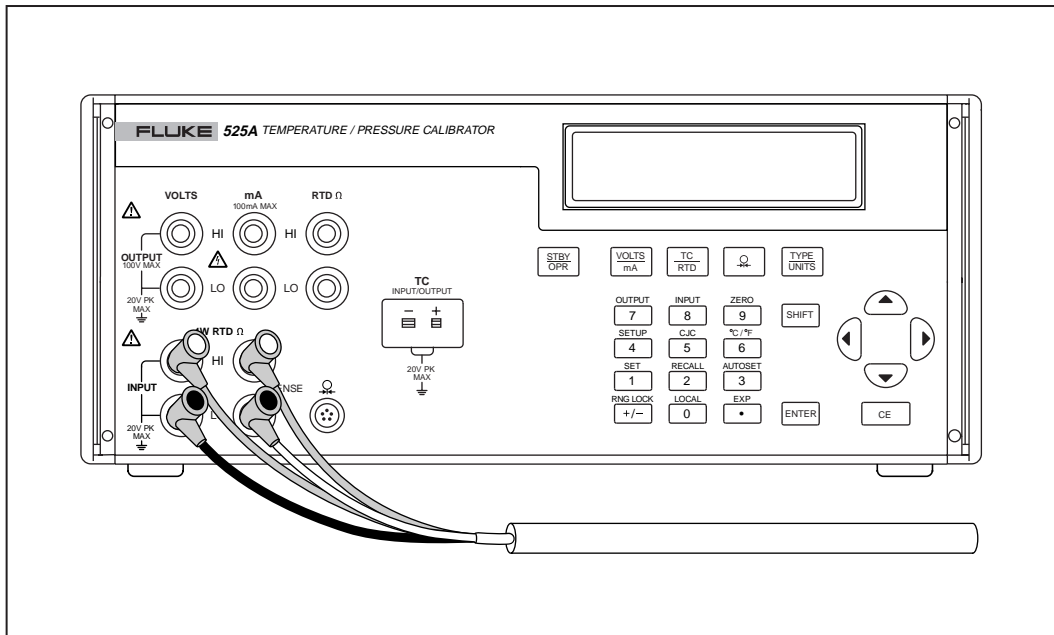

Figure 3-4. Measuring Temperature using an RTD Probe

ajr05f.wmf

## Entering and Using Custom RTDs

The USR\_DEF RTD type allows the Calibrator to simulate a custom curve-fit RTD.

### To enter the coefficients for custom RTDs

1. Press  to select RTD mode.
2. Press  until you get the USR\_DEF display.
3. Press  to enter custom RTD information. RTD CUSTOM (1-5) appears on the Calibrator display. You can store up to five custom RTD definitions on the Calibrator.
4. Press a number key to specify the RTD you want to define (1-5).
5. When the SET/RECALL display appears, press  to define a custom RTD coefficient.
6. Enter the MIN TEMP and press .
7. Enter the MAX TEMP and press .
8. Enter the nominal resistance ( $R_0$ ) and press .
9. Enter the temperature coefficients and press . Press   to enter a positive or negative exponent for the coefficient.

### To use a custom RTD

1. Press  to enter RTD mode.
2. Press  until you get the USR\_DEF display.
3. Press  to use custom RTD information. RTD CUSTOM (1-5) appears on the Calibrator display. You can store up to five custom RTD definitions on the Calibrator.
4. Press a number key to select the RTD you want to use (1-5).
5. When the SET/RECALL display appears, press  to recall and use the selected custom RTD.

### Default RTD Coefficients

The USR\_DEF function of the calibrator uses the Calendar-Van Dusen equation for outputting and measuring custom RTDs. The C coefficient is only used for the subrange -260 to 0 degrees Celsius. Only the A and B coefficients are needed for the subrange 0 to 630 degrees. The R0 is the resistance of the probe at 0 degrees Celsius. All of the USR\_DEF will be set to PT385 as shown in Table 2-1..

**Table 3-1. Default RTD Coefficients**

	Sub range	R <sub>0</sub>	Coefficient A	Coefficient B	Coefficient C
USR_DEF1	0 to 630	100	3.908X10-3	-5.8019X10-7	
USR_DEF2	-260 to 0	100	3.908X10-3	-5.8019X10-7	-5.8019X10-12
USR_DEF3	0 to 630	100	3.908X10-3	-5.8019X10-7	
USR_DEF4	-260 to 0	100	3.908X10-3	-5.8019X10-7	-5.8019X10-12
USR_DEF5	0 to 630	100	3.908X10-3	-5.8019X10-7	

If other types of RTD are required the table below shows the coefficients for PT391 and PT392. Again C is only used for temperatures below 0 Celsius.

**Table 3-2. Other Commonly Used RTDs**

RTD Type	Coefficient A	Coefficient B	Coefficient C
PT392	3.9848X10-3	-5.87X10-7	-4X10-12
PT391	3.9692X10-3	-5.8495X10-7	-4.2325X10-12

The SPRT 25 ohm function of the calibrator uses ITS-90 standard coefficients for measuring a SPRT. Since the five coefficients are deviations all of them will be set to 0.

*Note*

*The measuring function of the calibrator is limited to 100 ohms, so it can not be used for >100 ohm SPRT.*



## Entering Custom SPRT Coefficients

### To enter coefficients for a custom SPRT

1. Press  to enter RTD mode.
2. If necessary, press   for RTD IN mode.
3. Press  until you get the RTD IN SPRT display and press .
4. Enter the MIN TEMP and press .
5. Enter the MAX TEMP and press .
6. Enter the nominal resistance ( $R_0$ ) and press .
7. Enter the temperature coefficients and press . Press   to enter a positive or negative exponent for the coefficient.

## Measuring Pressure

Many ranges and types of pressure modules are available from Fluke. See “Accessories” in Chapter 6 of this manual for a complete list of supported pressure modules. Before you use a pressure module, read its instruction sheet. Pressure modules vary in use, media, and accuracy.

To measure pressure, attach the appropriate pressure module for the process pressure to be tested as shown in Figure 3-5.

### To measure pressure

1. Connect a pressure module to the Calibrator as shown in Figure 3-5.
2. Press  $\Omega$ . The Calibrator automatically senses which pressure module is attached and sets its range accordingly.
3. If appropriate, zero the pressure module as described in the module’s instruction sheet. Modules vary in zeroing procedures depending on the module type, but all require you to press  $\text{SHIFT}$   $9$ .
4. Pressurize the module with a pressure source to the desired level.

You can press  $\text{TYPE UNITS}$  to change pressure display units to psi, inH<sub>2</sub>O 4°C, inH<sub>2</sub>O 20°C, cmH<sub>2</sub>O 4°C, cmH<sub>2</sub>O 20°C, bar, mbar, kPa, inHg 0°C, mmHg 0°C, kg/cm<sup>2</sup>.

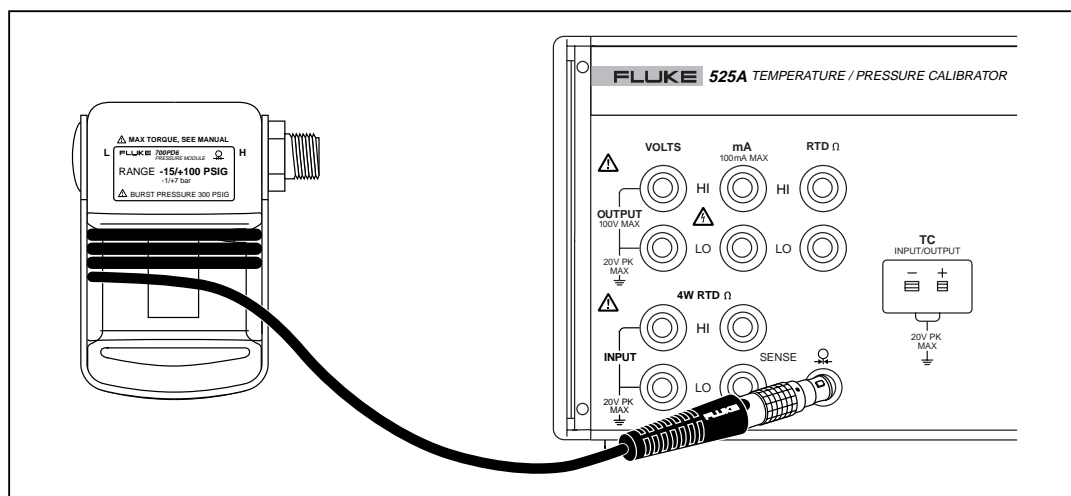

Figure 3-5. Connection for Measuring Pressure

ajr21f.eps

# Chapter 4

## Remote Operation

### Introduction

This chapter describes methods for operating the Calibrator by remote control. Remote control can be interactive, with the user controlling each step from a terminal, or under the control of a computer program running the Calibrator in an automated system. The Calibrator rear panel has two ports for remote operations: An RS-232 serial port and an optional IEEE-488 parallel port (also known as a General Purpose Interface Bus, or GPIB port).

**RS-232** The serial port connects the PC and Calibrator. You can write your own computer programs using the command set, or operate the PC as a terminal and enter individual commands, or you can purchase optional Fluke MET/CAL software for RS-232 system operations. Typical RS-232 remote configurations are shown in Figure 4-2.

**IEEE-488** The IEEE-488 parallel port is usually used in larger control and calibration systems. An IEEE-488 system has the ability to serve multiple Calibrators and multiple UUTs. Also, parallel system throughput is faster than serial system throughput. The controller in an IEEE-488 system is typically a Windows® compatible personal computer (PC) equipped with one or more IEEE-488 ports. You can write your own computer programs for system operation using the command set, or you can purchase optional Fluke calibration software MET/CAL. Typical IEEE-488 configurations are shown in Figure 4-3. The configuration showing the PC with two IEEE-488 ports is used with MET/CAL, which prefers UUTs on a separate IEEE-488 port. You can also “piggy-back” the connectors on a single IEEE-488 port.

After configuring the IEEE-488 or RS-232 port for remote operation, you are ready to begin using the command set. The operation of the command set is described under “Using Commands” in this chapter. A summary of remote commands is in Chapter 5, “Remote Commands.”

## Setting up the RS-232 Port for Remote Control

The Calibrator is fully programmable over an RS-232 link with a PC. You can enter individual commands from a terminal, write your own programs using, for example, a Windows®-based language such as Visual Basic, or run optional Windows®-based Fluke software such as MET/CAL.

The RS-232 cable length for the port should not exceed 15 meters (50 feet), although longer cable lengths are permitted if the load capacitance measured at a connection point (including signal terminator) does not exceed 2500 pF.

### RS-232 Port Setup Procedure

Serial parameters are fixed with the values shown below:

- 9600 baud
- 8 data bits
- 1 stop bit
- no parity
- Xon/Xoff
- EOL (end-of-line) character CR (Carriage Return)

### Testing the RS-232 Port

Use the following procedure to test the Calibrator RS-232 Port connected to a PC COM port. A typical connection is shown in Figure 4-1. Note the use of a null modem cable for connection.

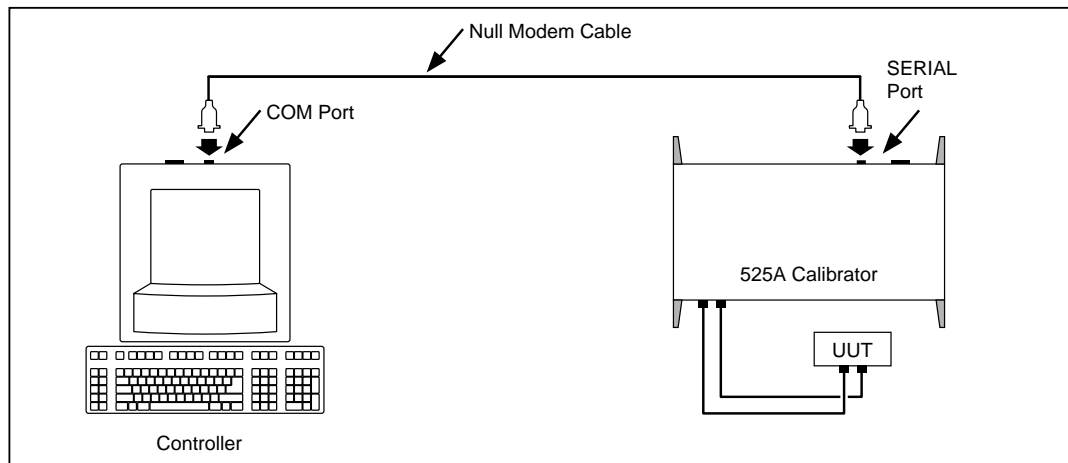

Figure 4-1. Testing the RS-232 Port

ajr14f.eps

Complete the following procedure to test RS-232 port operation using the Windows® HyperTerminal application (or equivalent).

**To test port operation**

1. Select Start->Programs->Accessories->Hyperterminal->Hyper Terminal.
2. Enter 525A for Name:, and select OK.
3. Select PC serial port which 525A is connected to (from drop-down list), for Connect using: and select OK
4. Select the following setting and then select OK:
  - Bits per second: 9600
  - Data bits: 8
  - Parity: None
  - Stop bits: 1
  - Flow control: Xon / Xoff
5. Select File->Properties->Settings->ASCII Setup.
6. Select the following settings and then select OK:
  - Echo typed characters locally
  - Append line feeds to incoming line ends
7. Select OK.
8. Enter \*IDN? and press Enter.
9. Verify that that the returned string is Fluke,525A,0,<firmware revision>.

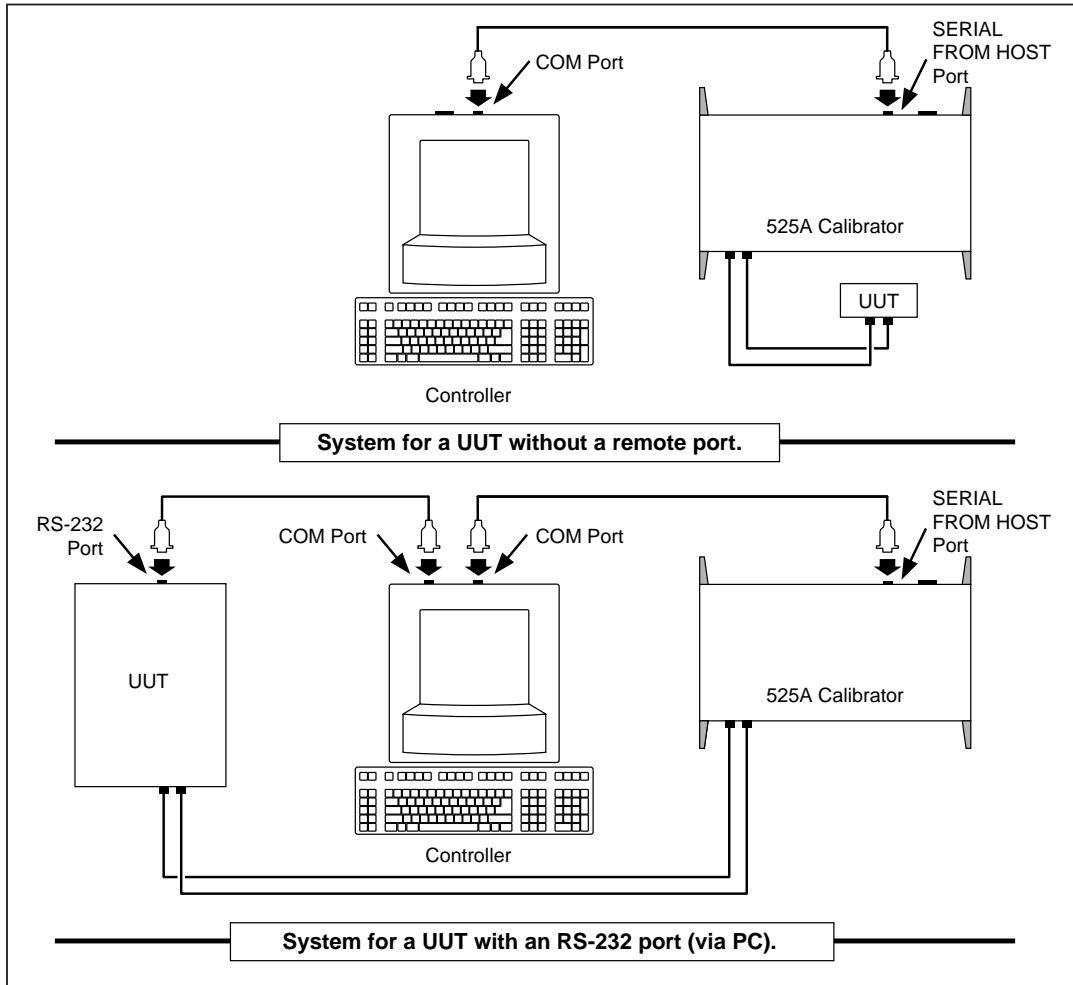

ajr15f.eps

Figure 4-2. Typical RS-232 Remote Control Connections

## RS-232 Interface Overview

The Calibrator RS-232 port is designed in accordance with EIA (Electronic Industries Association) standard RS-232-C. RS-232 is a serial binary data interchange operating at 9600 baud and distances up to 50 feet. The Calibrator rear panel serial port is configured as DTE (Data Terminal Equipment). For detailed information, see the EIA standard RS-232-C.

A summary of RS-232 terms, interface lines and mnemonics are shown in Table 4-1.

**Table 4-1. RS-232 Interface Wiring**

Mnemonic	Description
DB-9	Type DB connector, 9 pins
DTE	Data Terminal Equipment
GND	Ground
RX	Receive Line
TX	Transmit Line

## Setting up the IEEE-488 Port for Remote Control

The Calibrator is fully programmable for use on the IEEE Standard 488 interface bus. The IEEE-488 interface is also designed in compliance with supplemental standard IEEE-488.2, which describes additional IEEE-488 features. Devices connected to the IEEE-488 bus are designated as talkers, listeners, talker/listeners, or controllers. Under remote control of an instrument, the Calibrator operates as a talker/listener.

A PC equipped with an IEEE-488 interface controls the Calibrator. Compatible software for IEEE-488 operation, MET/CAL, may be purchased from Fluke.

When using the IEEE-488 remote control interface, there are two restrictions:

1. **Number of Devices** A maximum of 15 devices can be connected in a single IEEE-488 bus system. For example, one instrument controller, one Calibrator, and thirteen units under test (UUTs).
2. **Cable Length** The total length of IEEE-488 cables used in one IEEE-488 system is 2 meters times the number of devices in the system, or 20 meters, whichever is less. For example, if 8 devices are connected, the maximum cable length is  $2 \times 8 = 16$  meters. If 15 devices are connected, the maximum cable length is 20 meters.

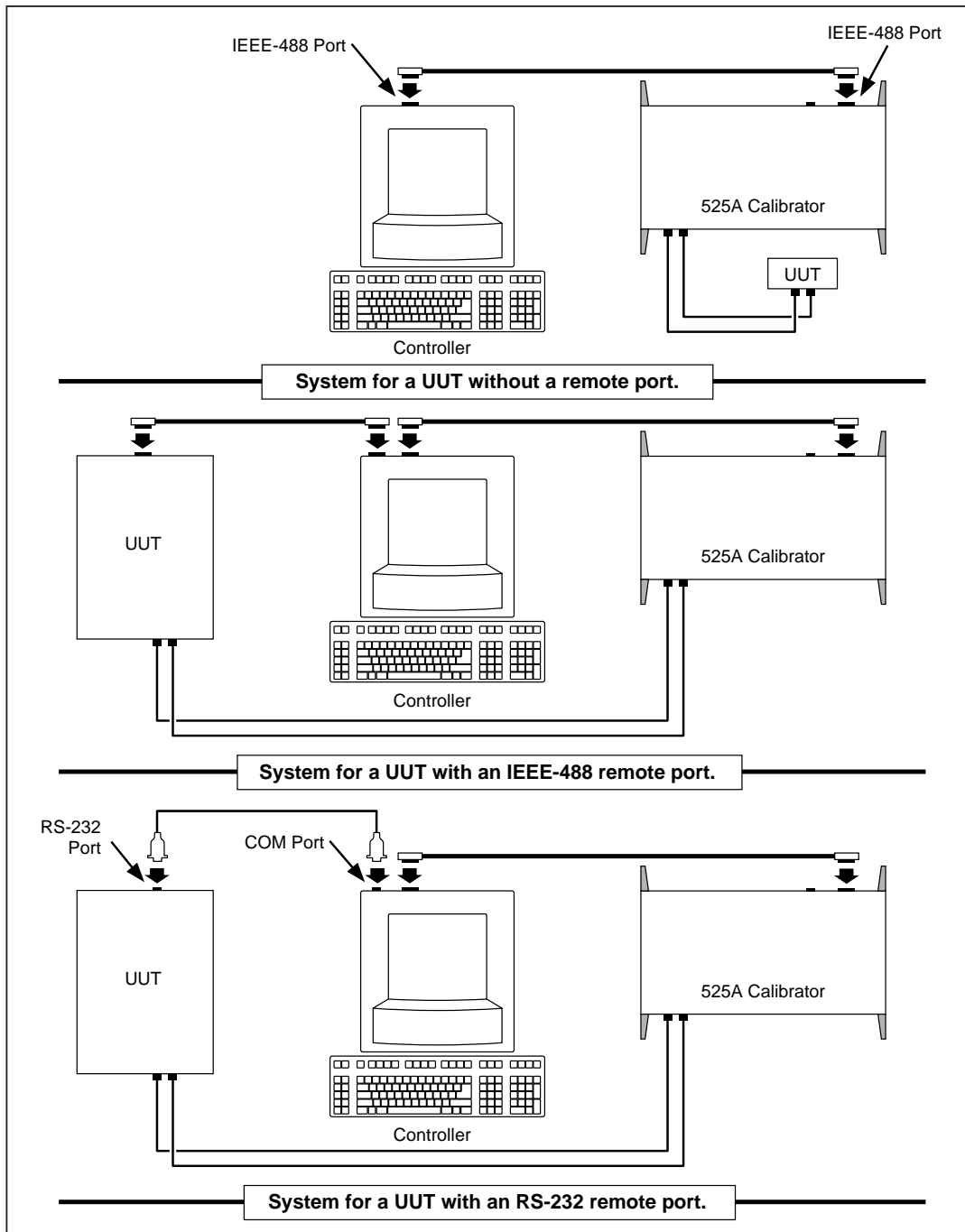

Figure 4-3. Typical IEEE-488 Remote Control Connections

ajr13f.eps



### IEEE-488 Port Setup Procedure

Complete the following procedure to set up the Calibrator for remote operations using the IEEE-488 remote control port. The purpose is to select GPIB as the interface and to select the GPIB address for the interface.

#### To set up the IEEE-488 port

1. Turn the Calibrator power on and wait until the initialization procedure completes. You may operate the Calibrator during warm-up, but specifications are not guaranteed until warm-up is complete.
2. Press SETUP (SHIFT + 4).
3. Press ENTER until Remote Interface: is displayed.
4. Press the  $\Delta$  or  $\nabla$  key to select GPIB, if not already selected.
5. Press ENTER until Address: is displayed.
6. Press the  $\Delta$  or  $\nabla$  key to select the desired address. The factory default is 4.
7. Press ENTER to exit the Setup menu.

### Testing the IEEE-488 Port

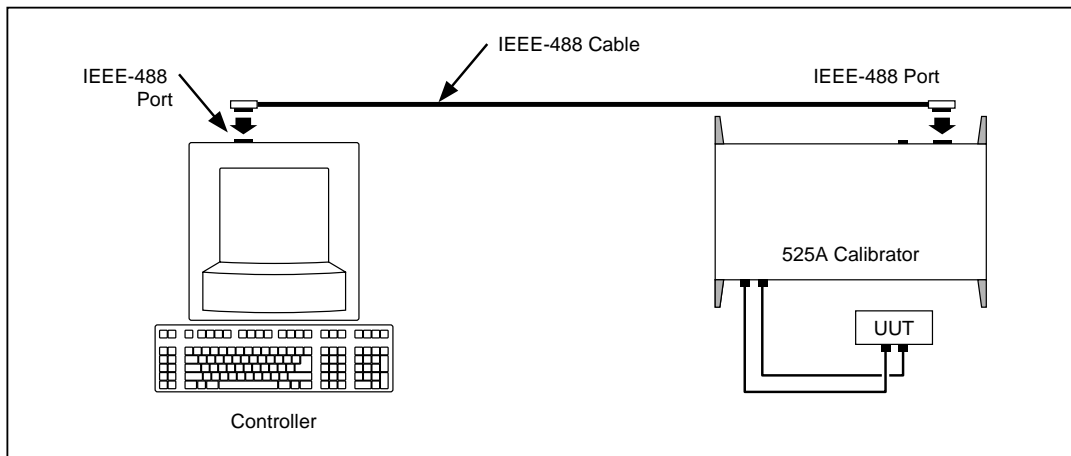

**Figure 4-4. Testing the IEEE-488 Port**

ajr16f.eps

It is beyond the scope of this manual to describe how to test the 525A IEEE-488 interface in general because Windows is not provided by default with an application to exercise a device attached to an IEEE-488 interface card. However if MET/CAL has been purchased, the following steps may be performed to verify that the 525A IEEE-488 interface is functioning properly:

**To test the IEEE-488 port**

1. Open the MET/CAL Editor application.
2. Select File->New or press Ctrl+N.
3. Enter IEEE [@4]\*IDN?[I\$]. If you did not select address 4 in step 6 above, substitute the address you entered for the **4**.
4. Select Edit->Name Procedure or press Ctrl+I and enter Test 525A GPIB.
5. Select Compile->Next Error or press F9.
6. Select Test Run->Restart or press F2.
7. Check the S-Reg check box.
8. Select Run.
9. Verify that the S-Reg (MEM2) window displays Fluke,525A,0,<firmware rev.>.
10. Select Quit.
11. Select File->Save or press Ctrl+S to save the procedure.
12. Exit the MET/CAL Editor.

## ***Changing Between Remote and Local Operation***

In addition to Local mode (front panel operation) and remote, the Calibrator can be placed in a local lockout condition at any time by command of the controller. Combined, the local, remote, and lockout conditions yield four possible operating states described as follows.

### ***Local State***

The Calibrator responds to local and remote commands. This is normal front panel operation. All remote commands are allowed to execute.

### ***Local with Lockout State***

Local with lockout is identical to local, except the Calibrator will go into the remote with lockout state instead of the remote state when it receives a remote command. You can only enter the Local with Lockout State by sending the IEEE-488 GTL (Go to Local) message when the 525A is in remote with lockout.

### ***Remote State***

When the Calibrator is placed in remote, either via RS-232 REMOTE command, or via IEEE-488 asserting the REN line, it enters the remote state. The top line of the display changes to: **REM**.

Front panel operation is disabled except for the **LOCAL** (0 key). Pressing **0**, using RS-232 to send the command **LOCAL**, or IEEE-488 to send the **GTL** (Go To Local) message returns the Calibrator to the local state.

**Remote with Lockout State**

When the Calibrator is placed in lockout, either via RS-232 **LOCKOUT** command, or via the IEEE-488 message **LLO**, the 525A front panel controls are totally locked out. The top line of the display changes to: **REM**.

To return the Calibrator to the local with lockout state, send the RS-232 **LOCAL** command or the IEEE-488 **GTL** (Go To Local) message.

Table 4-2 summarizes the possible Operating state transitions. (For more information on IEEE-488 GPIB messages, see “IEEE-488 Overview.”)

**Table 4-2. Operating State Transitions**

<b>From</b>	<b>To</b>	<b>Front Panel</b>	<b>GPIB Message</b>	<b>Serial Command</b>
Local	Remote		MLA (REN True)	REMOTE
	Local with Lockout		LLO	LOCKOUT
Remote	Local	Local softkey	GTL or REN False	LOCAL
	Remote with Lockout		LLO	LOCKOUT
Local with Lockout	Local		REN False	LOCAL
	Remote with Lockout		MLA (REN True)	REMOTE
Remote with Lockout	Local		REN False	LOCAL
	Local with Lockout		GTL	

## IEEE-488 Interface Overview

The IEEE-488 parallel interface sends commands as data and receives measurements and messages as data. The maximum data exchange rate is 1 Mbyte, with a maximum distance of 20 meters for the sum length of the connecting cables. A single cable should not exceed 4 meters in length. Some commands are reserved for RS-232 serial operation because these functions must be implemented as IEEE messages per the IEEE Standards. For example, the command REMOTE could be sent as data over the IEEE-488 interface to place the Calibrator into remote, but it is not because the IEEE Standards call for the remote function to be sent to the device as the uniline message REN. This is also true for several other commands and functions, as shown below, with their equivalent RS-232 emulation. A summary of IEEE-488 messages is shown in Table 4-3.

**Table 4-3. RS-232 Emulation of IEEE-488 Messages**

IEEE-488 Message	RS-232 Equivalent
GTL	LOCAL command
GTR	REMOTE command
LLO	LOCKOUT command
SDC, DCL	(not emulated on RS-232)
GET	(not emulated on RS-232)
SPE, SPD	(not emulated on RS-232)
UNL, UNT	(not emulated on RS-232)

The IEEE-488 interface is based on the IEEE Standards 488.1 and 488.2. For detailed information, refer to the IEEE-488.1 and IEEE-488.2 standards.

**IEEE-488.1** IEEE-488.1 is the hardware portion of the interface. The parallel signal lines are divided into eight lines for the data bus, three lines for the handshake, and five lines for bus management. The handshake lines take care of the timing for data exchange. The bus management lines control the operation of data exchange. The ATN line indicates the use of the DIO lines for addresses or messages (true), or for DIO data (false). The EOI line is used with the data lines to mark the end of a message, and with the ATN line for polling. The SRQ line is used by the devices to indicate to the controller that they require service. The IFC line is used by the controller to quickly get all the devices on the bus to stop talking and start listening. The REN line is used to implement the remote/local states.

**IEEE-488.2** IEEE-488.2 is the software portion of the interface, specifying data formats, common commands, message exchange protocol and the status register implementation. Use the following to decode the columns in Table 4-4.

- Type    M - Multiline  
          U - Uniline
  
- Class    AC - Addressed Command                      DD - Device Dependent  
          AD - Address (Talk or listen)                HS - Handshake  
          UC - Universal Command                      SE - Secondary  
          ST - Status
  
- Other    B1, B2, etc. - Information Bits                    Logic Zero = 0 = False  
          Blanks - Doesn't Care condition            Logic One = 1 = True

**Table 4-4. IEEE-488 Remote Message Coding**

MESSAGE DESCRIPTION			DATA BUS									HAND-SHAKE			BUS MANAGEMENT						
M N E M	MESSAGE  NAME	T	C	D	D	D	D	D	D	D	D	D	D	N	N	A	E	S	I	R	
		P	L	I	I	I	I	I	I	I	I	I	I	V	F	D	T	O	R	F	E
		E	S	8	7	6	5	4	3	2	1				A	C	N	I	Q	C	N
ACG	Addressed Command Group	M	AC		0	0	0										1				
ATN	Attention	U	UC														1				
DAB	Data Byte	M	DD	B8	B7	B6	B5	B4	B3	B2	B1						0				
DAC	Data Accepted	U	HS												0						

Table 4-4 IEEE-488 Remote Message Coding (continued)

MESSAGE DESCRIPTION		DATA BUS										HAND-SHAKE			BUS MANAGEMENT				
M N E M	MESSAGE NAME	T Y P E	C L A S S	D 8	D 7	D 6	D 5	D 4	D 3	D 2	D 1	DAV	N R F D	N D A C	A T N	E O I	S R Q	I F C	R E N
DAV	Data Valid	U	HS									1							
DCL	Device Clear	M	UC	0	0	1	0	1	0	0					1				
END	End	U	ST												0	1			
EOS	End Of String	M	DD	B8	B7	B6	B5	B4	B3	B2	B1				0				
GET	Group Execute Trigger	M	AC	0	0	0	1	0	0	0					1				
GTL	Go To Local	M	AC	0	0	0	0	0	0	1					1				
IDY	Identify	U	UC													1			
IFC	Interface Clear	U	UC															1	
LAG	Listen Address Group	M	AD	0	1										1				
LLO	Local Lock Out	M	UC	0	0	1	0	0	0	1					1				
MLA	My Listen Address	M	AD	0	1	B5	B4	B3	B2	B1					1				
MTA	My Talk Address	M	AD	1	0	B5	B4	B3	B2	B1					1				
MSA	My Secondary Address	M	SE	1	1	B5	B4	B3	B2	B1					1				
NUL	Null Byte	M	DD	0	0	0	0	0	0	0									
OSA	Other Secondary Address	M	SE	(OSA = SCG and MSA-NOT)															
OTA	Other Talk Address	M	AD	(OTA = TAG and MTA-NOT)															
PCG	Primary Command Group	M	----	(PCG = ACG or UCG or LAG or TAG)															
PPC	Parallel Poll Configure	M	AC	0	0	0	0	1	0	1					1				
PPE	Parallel Poll Enable	M	SE	1	1	0	B4	B3	B2	B1					1				
PPD	Parallel Poll Disable	M	SE	1	1	1	B4	B3	B2	B1					1				
PPR1	Parallel Poll Response 1	U	ST								1				1	1			
PPR2	Parallel Poll Response 2	U	ST						1						1	1			
PPR3	Parallel Poll Response 3	U	ST					1							1	1			
PPR4	Parallel Poll Response 4	U	ST				1								1	1			
PPR5	Parallel Poll Response 5	U	ST			1									1	1			
PPR6	Parallel Poll Response 6	U	ST		1										1	1			
PPR7	Parallel Poll Response 7	U	ST	1											1	1			
PPR8	Parallel Poll Response 8	U	ST	1											1	1			
PPU	Parallel Poll Unconfigure	M	UC	0	0	1	0	1	0	1					1				
REN	Remote Enable	U	UC																1

**Table 4-4 IEEE-488 Remote Message Coding (continued)**

MESSAGE DESCRIPTION		DATA BUS										HAND-SHAKE			BUS MANAGEMENT					
M N E M	MESSAGE  NAME	T	C	D	D	D	D	D	D	D	D	D	D	N	N	A	E	S	I	R
		Y	L	I	I	I	I	I	I	I	I	I	I	A	R	D	T	O	R	F
		P	A	O	O	O	O	O	O	O	O	O	V	F	A	N	I	Q	C	N
		E	S	8	7	6	5	4	3	2	1		D	C						
RFD	Ready For Data	U	HS										0							
RQS	Request For Service	U	ST		1											0				
SCG	Secondary Command Group	M	SE		1	1										1				
SDC	Selected Device Clear	M	AC		0	0	0	0	1	0	0					1				
SPD	Serial Poll Disable	M	UC		0	0	1	1	0	0	1					1				
SPE	Serial Poll Enable	M	UC		0	0	1	1	0	0	0					1				
SRQ	Service Request	U	ST															1		
STB	Status Byte	M	ST	B8		B6	B5	B4	B3	B2	B1					0				
TCT	Take Control	M	AC		0	0	0	1	0	0	1					1				
TAG	Talk Address Group	M	AD		1	0										1				
UCG	Universal Command Group	M	UC		0	0	1									1				
UNL	Unlisten	M	AD		0	1	1	1	1	1	1					1				
UNT	Untalk	M	AD		1	0	1	1	1	1	1					1				

## Using Commands

Communications between the controller and the Calibrator consists of commands, queries, and interface messages. Although the commands are based on the 488.2 standard, they can be used on either the IEEE-488 or RS-232 interface, except for a few specialized RS-232 commands described in “Commands for RS-232 Only.” (For more information on command structures, see the IEEE 488.2 standard.)

Refer to Chapter 5, “Remote Commands” when you require additional information about command references used this chapter.

All commands and units may be entered in UPPER or lower case.

There are two remote control configurations that use commands, queries and interface messages: IEEE-488 and RS-232 mode. (Setting up and testing each mode is discussed earlier in this chapter.)

**IEEE-488 Mode** The IEEE-488 mode is used when the Calibrator is operated by computer program. In this mode, requested information is returned by query, and interface messages are queued and returned by command.

**RS-232 Mode** The RS-232 mode is used when the Calibrator is operated by terminal or computer program. In this mode, requested information is returned by query, and interface messages are queued and returned by command.

### **Types of Commands**

The commands for the Calibrator can be grouped into one or more categories, depending on how they function. Each category is described below.

#### **Device-Dependent Commands**

Device-dependent commands are unique to the Calibrator. An example of a device-dependent command is,

```
OUT 1 V
```

instructing the Calibrator to source 1 volt dc.

#### **Common Commands**

Common commands are defined by the IEEE 488.2 standard and are common to most bus devices. Common commands always begin with an \* character. Common commands are available whether you are using the IEEE-488 or RS-232 interface for remote control. An example of a common command is,

```
*IDN?
```

instructing the Calibrator to return the instrument identification string.

#### **Query Commands**

Query commands request information, which is returned as the command executes, or placed in a buffer until requested. An example of a query, which always ends with a question mark, is,

```
RANGE?
```

returning the Calibrator dc voltage output range.

#### **Interface Messages (IEEE-488)**

Interface messages manage traffic on the IEEE-488 interface bus. Device addressing and clearing, data handshaking, and commands to place status bytes on the bus are all directed by interface messages. Some of the interface messages occur as state transitions of dedicated control lines. The rest of the interface messages are sent over the data lines with the ATN signal true. (All device-dependent and common commands are sent over the data lines with the ATN signal false.)



An important thing to note about interface messages is that unlike device-dependent and common commands, interface messages are not sent literally (in a direct way). For example, when you send a device-dependent query to the Calibrator, the controller automatically sends the interface message MTA (My Talk Address).

IEEE-488 standards define interface messages. Table 4-5 lists the interface messages that the Calibrator accepts. Table 4-5 also shows the BASIC statement to generate the interface message. Table 4-6 lists the interface messages that the Calibrator sends. The mnemonics listed in the tables are not sent in BASIC PRINT statements as commands are; in this way they are different from device-dependent and common commands.

Interface messages are handled automatically in most cases. For example, handshake messages DAV, DAC, and RFD automatically occur under the direction of an instrument's interface itself as each byte is sent over the bus.

**Table 4-5. IEEE-488 Interface Messages (Received)**

<b>Mnemonic</b>	<b>Name</b>	<b>Function</b>
ATN	Attention	A control line that, when asserted, notifies all instruments on the bus that the next data bytes are an interface message. When ATN is low, the next data bytes are interpreted as device-dependent or common commands addressed to a specific instrument.
DAC	Data Accepted	Sets the handshake signal line NDAC low.
DAV	Data Valid	Asserts the handshake signal line DAV.
DCL	Device Clear	Clears the input/output buffers
END	End	A message that occurs when the Controller asserts the EOI signal line before sending a byte.
GET	Group Execute Trigger	Trigger a TC measurement and put the reading in the output buffer.
GTL	Go To Local	Transfer control of the 525A from one of the remote states to one of the local states. (See Table 4-2)
LLO	Local Lockout	Transfers remote/local control of the 525A. (See Table 4-2)
IFC	Interface Clear	A control line that sets the interface to a quiescent state.
MLA	My Listen Address	Addresses a specific device on the bus as a listener. The controller sends MLA automatically whenever it directs a device-dependent or common command to a specific instrument.
MTA	My Talk Address	Addresses a specific device on the bus as a talker. The controller sends MTA automatically whenever it directs a device-dependent or common query to a specific instrument.
REN	Remote Enable	Transfer remote/local control of the 525A. (See Table 4-2.)
RFD	Ready For Data	Sets the handshake signal line NRFD low.
SDC	Selected Device Clear	Does the same thing as DCL, but only if the 525A is currently addressed as a listener.
SPD	Serial Poll Disable	Cancel the effect of a Serial Poll Enable.
SPE	Serial Poll Enable	After the 525A receives this message, it sends the Status Byte the next if is addressed as a listener, no matter what the command is.
UNL	Unlisten	"Unaddresses" a specific device on the bus as a listener. The controller sends UNL automatically after the device has successfully received a device-dependent or common command.
UNT	Untalk	"Unaddresses" a specific device on the bus as a listener. The controller sends UNL automatically after the device has successfully received a device-dependent or common query.

**Table 4-6. IEEE-488 Interface Messages (Sent)**

Mnemonic	Name	Function
END	End	A message that occurs when the 525A asserts the EOI control line. The 525A asserts EOI while it transmits the ASCII character LF for its termination sequence or terminator.
DAC	Data Accepted	Set the handshake signal line NDAC low.
DAV	Data Valid	Asserts the handshake signal line DAV.
RFD	Ready for Data	Sets the handshake line NRFD low.
SRQ	Service Request	A control line that any device on the bus can assert to indicate that it requires attention. Refer to "Checking 525A Status" for details.
STB	Status Byte	The status byte is what the 525A sends when it responds to a serial poll (interface message SPE).

### Compound Commands

A compound command is two or more commands in a single command line. For example, the following two commands could be entered individually,

```
OUT 1 V
OPER
```

where the Calibrator sources 1 V dc, and then goes into operate, or they could be combined into a compound command,

```
OUT 1 V ; OPER
```

using a semi-colon as a separator.

### Overlapped Commands

Commands that begin execution but require slightly more time to complete are called overlapped commands, because they can be overlapped by the next command before they have completed execution.

In Chapter 5, the command graphic  Overlapped shows a check for overlapped commands.

You can use the command \*WAI to wait until the overlapped command has completed execution before executing the next command. For example,

```
OUT 1 V ; *WAI
```

You can also use the status commands \*OPC and \*OPC? to detect completion of overlapped commands. (See “Checking 525A Status.”)

### Sequential Commands

Commands that execute immediately are called sequential commands.

In Chapter5, the command graphic  Sequential shows a check for sequential commands.

The majority of the commands are sequential.

### Commands for RS-232 Only

The command graphic  IEEE-488  RS-232 indicates RS-232 interface commands.

The IEEE-488 and RS-232 interfaces both send commands to the Calibrator as data, except for those IEEE-488 functions that must be implemented as a message as specified in the IEEE-488 standards. For example, the RS-232 interface uses the command REMOTE to place the Calibrator in the Remote mode. Although the IEEE-488 interface could also send a command REMOTE as data, it does not because this is one of the functions that must be implemented per IEEE-488 Standards. The relationship between these IEEE-488 messages and the equivalent RS-232 emulation is shown in Table4-7.

**Table 4-7. Commands for RS-232 Only**

IEEE-488 Message [1]	RS-232 Equivalent
GTL	LOCAL command
GTR	REMOTE command
LLO	LOCKOUT command

### Commands for IEEE-488 Only

The command graphic  IEEE-488 indicates commands that are used for the IEEE-488 interface. This is all the commands, except for those used for RS-232 operations. (See “Commands for RS-232 Only.”) All commands are transferred over the IEEE-488 as data, except for the commands LOCAL, REMOTE, and LOCKOUT, which are implemented per IEEE Standards as messages.

### **Command Syntax**

The following syntax rules apply to all the remote commands. Information about syntax of response messages is also given.

### **Parameter Syntax Rules**

Table 4-8 lists the units accepted in command parameters and used in responses. All commands and units may be entered in upper or lower case.

**Table 4-8. Units Accepted in Parameters and Used in Responses**

Units	Meaning
uV	Volts in units of microvolts <sup>1</sup>
mV	Volts in units of millivolts <sup>1</sup>
V	Volts in units of volts
kV	Volts in units of kilovolts <sup>1</sup>
uA	Current in units of microamperes <sup>1</sup>
mA	Current in units of milliamps <sup>1</sup>
A	Current in units of amps
Ohm	Resistance in units of ohms
kOhm	Resistance in units of kilohms <sup>1</sup>
MOhm	Resistance in units of megohms <sup>1</sup>
cel	Temperature in degrees Celsius
far	Temperature in degrees Fahrenheit
psi	Pressure in pound-force per square inch
mmHg	Pressure in millimeters of mercury
inHg	Pressure in inches of mercury
inH2O4C	Pressure in inches of water at 4 °C
inH2O20C	Pressure in inches of water at 20 °C
cmH2O4C	Pressure in centimeters of water at 4 °C
CmH2O20C	Pressure in centimeters of water at 20 °C
bar	Pressure in bar
mbar	Pressure in millibar
kpal	Pressure in kilopascal
kg/cm2	Pressure in kilograms per square centimeter
1. Parameter only	

**General Rules** The general rules for parameter usage is as follows:

1. Numeric parameters may have up to 15 significant digits and their exponents can be in the range +/-1.0E+/-20.
2. Including too many or too few parameters causes a command error.
3. Null parameters cause an error, e.g., the adjacent commas in `OUT 1V, , ;OPER.`
4. Expressions, for example `4+2*13`, are not allowed as parameters.

### Extra Space or Tab Characters

In the command descriptions in Chapter 5, parameters are shown separated by spaces. One space after a command is required (unless no parameters are required). All other spaces are optional. Spaces are inserted for clarity in the manual and may be left in or omitted as desired. You can insert extra spaces or tabs between parameters as desired. Extra spaces within a parameter are generally not allowed, except for between a number and its associated multiplier or unit. Chapter 5 contains examples for commands whose parameters or responses are not self-explanatory.

### Terminators

Table 4-9 summarizes the terminator characters for both the IEEE-488 and RS-232 remote interfaces.

**Table 4-9. Terminator Characters**

Terminator	ASCII Character		Control Command	Language Command
	Number	Program		
Carriage Return (CR)	13	Chr(13)	<Cntl> M	\n
Line Feed (LF)	10	Chr(10)	<Cntl> J	\r
Backspace (BS)	8	Chr(8)	<Cntl> H	\b
Form Feed (FF)	12	Chr(12)	<Cntl> L	\f
Examples:				
RS-232 Mode using a terminal <code>OUT 1 V &lt;Enter&gt;</code>				
RS-232 Mode using a program <code>Comm1.Output = "OUT 1 V" + Chr(10)</code>				
IEEE-488 Mode <code>OUT 1 V</code>				

**IEEE-488 Interface** The Calibrator sends the ASCII character Carriage Return with the EOI control line held high as the terminator for response messages. The calibrator recognizes the following as terminators when encountered in incoming data:

- ASCII CR character
- Any ASCII character sent with the EOI control line asserted

**RS-232 Interface** The Calibrator returns a Carriage Return (CR) character with each response. The calibrator recognizes the following as terminators when encountered in incoming data:

- ASCII CR character
- ASCII LF character

### *Incoming Character Processing*

The Calibrator processes all incoming data as follows (except Binary Block Data as described under Parameter Syntax Rules):

1. The most significant data bit (DIO8) is ignored.
2. All data is taken as 7-bit ASCII.
3. Lower-case or upper-case characters are accepted.
4. ASCII characters whose decimal equivalent is less than 32 (Space) are discarded, except for characters 10 (LF) and 13 (CR).

### *Response Message Syntax*

In the command descriptions in Chapter 5, responses from the Calibrator are described wherever appropriate. In order to know what type of data to read in, refer to the first part of the entry under "Response" in the tables. The response is identified as one of the data types in Table 4-10.

Table 4-10. Response Data Types

Data Type	Description
Integer	<p>Integers for some controllers or computers are decimal numbers in the range -32768 to 32768.</p> <p>Responses in this range are labeled Integer.</p> <p>Example: *ESE 123; *ESE?</p> <p>Returns: 123</p>
Floating	<p>Numbers that may have up to 15 significant figures plus an exponent that may range from <math>\pm E20</math>.</p> <p>Example: OUT?</p> <p>Returns: 1.429300E+00</p>
Character Response Data (CRD)	<p>This type of response is always a keyword.</p> <p>Example: OUT 1V; FUNC?</p> <p>Returns: DCV</p>
Indefinite ASCII (IAD)	<p>Any ASCII characters followed by EOM. Queries with this type of response MUST be the last Query in a program message.</p> <p>Example: *IDN?</p> <p>Returns: FLUKE,525A,&lt;serial number&gt;,&lt;firmware version&gt;</p>



## Checking 525A Status

You have access to status registers, enable registers, and queues in the Calibrator to indicate various conditions in the instrument as shown in Figure 4-5. Some registers and queues are defined by the IEEE-488.2 standard. The rest are specific to the Calibrator. In addition to the status registers, the Service Request (SRQ) control line, and a 16-element buffer called the Error Queue provide status information. Table 4-11 lists the status registers and gives the read/write commands and associated mask registers.

**Table 4-11. Status Register Summary**

Status Register	Read Command	Write Command
Serial Poll Status Byte (STB)	*STB?	—
Service Request Enable Register (SRE)	*SRE?	*SRE
Event Status Register (ESR)	*ESR?	—
Event Status Enable Register (ESE)	*ESE?	*ESE

Each status register and queue has a summary bit in the Serial Poll Status Byte. Enable registers are used to mask various bits in the status registers and generate summary bits in the Serial Poll Status Byte. For IEEE-488 interface operation, the Service Request Enable Register is used to assert the SRQ control line on detection of any status condition or conditions the programmer chooses. For RS-232 interface operation, the SRQSTR string is sent over the serial interface when the SRQ line is set. (See the SRQSTR command description in Chapter 5 for more information.)

### Serial Poll Status Byte (STB)

The Calibrator sends the serial poll status byte (STB) when it responds to a serial poll. This byte is cleared (set to 0) when the power is turned on. The STB byte is defined as shown in Figure 4-5. Refer to the \*STB? Command for RS-232 interface operation in Chapter 5 for more information.

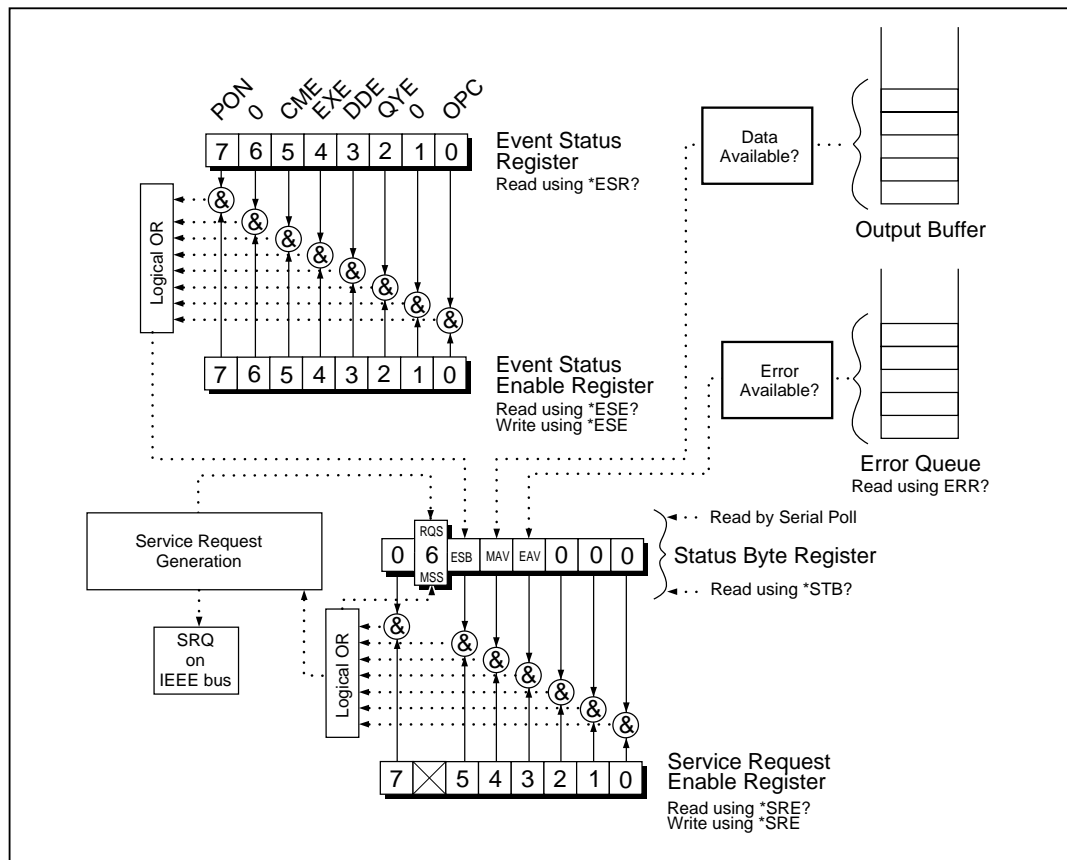

ajr19f.eps

Figure 4-5. Status Register Overview

7	6	5	4	3	2	1	0
0	<b>RQS</b>	<b>ESB</b>	<b>MAV</b>	<b>EAV</b>	<b>0</b>	<b>0</b>	<b>0</b>
	<b>MSS</b>						

<b>RQS</b>	Requesting service. The RQS bit is set to 1 whenever bits ESB, MAV, EAV, or ISCB change from 0 to 1 and are enabled (1) in the SRE. When RQS is 1, the 525A asserts the SRQ control line on the IEEE-488 interface. You can do a serial poll to read this bit to see if the 525A is the source of an SRQ.
<b>MSS</b>	Master summary status. Set to 1 whenever bits ESB, MAV, EAV, or ISCB are 1 and enabled (1) in the SRE. This bit can be read using the *STB? command in serial remote control in place of doing a serial poll.
<b>ESB</b>	Set to 1 when one or more ESR bits are 1.
<b>MAV</b>	Message available. The MAV bit is set to 1 whenever data is available in the 525A's IEEE-488 interface output buffer.
<b>EAV</b>	Error available. An error has occurred and an error is available to be read from the error queue by using the ERR? query.

ajr18f.eps

**Figure 4-6. Serial Poll Status Byte (STB) and Service Request Enable (SRE)**

### Service Request (SRQ) Line

**IEEE-488** Service Request (SRQ) is an IEEE-488.1 bus control line that the Calibrator asserts to notify the controller that it requires some type of service. Many instruments can be on the bus, but they all share a single SRQ line. To determine which instrument set SRQ, the Controller normally does a serial poll of each instrument. The calibrator asserts SRQ whenever the RQS bit in its Serial Poll Status Byte is 1. This bit informs the controller that the Calibrator was the source of the SRQ.

The Calibrator clears SRQ and RQS whenever the controller/host performs a serial poll, sends \*CLS, or whenever the MSS bit is cleared. The MSS bit is cleared only when ESB and MAV are 0, or they are disabled by their associated enable bits in the SRE register being set to 0.

### *Service Request Enable Register (SRE)*

The Service Request Enable Register (SRE) enables or masks the bits of the Serial Poll Status Byte. The SRE is cleared at power up. Refer to Figure 4-6 for the bit functions.

### *Programming the STB and SRE*

By resetting (to 0) the bits in the SRE, you can mask (disable) associated bits in the serial poll status byte. Bits set to 1 enable the associated bit in the serial poll status byte.

### *Event Status Register (ESR)*

The Event Status Register is a two-byte register in which the higher eight bits are always 0, and the lower eight bits represent various conditions of the Calibrator. The ESR is cleared (set to 0) when the power is turned on, and every time it is read.

Many of the remote commands require parameters. Improper use of parameters causes command errors to occur. When a command error occurs, bit CME (5) in the Event Status Register (ESR) goes to 1 (if enabled in ESE register), and the error is logged in the error queue.

### *Event Status Enable (ESE) Register*

A mask register called the Event Status Enable register (ESE) allows the controller to enable or mask (disable) each bit in the ESR. When a bit in the ESE is 1, the corresponding bit in the ESR is enabled. When any enabled bit in the ESR is 1, the ESB bit in the Serial Poll Status Byte also goes to 1. The ESR bit stays 1 until the controller reads the ESR or does a device clear, a selected device clear, or sends the reset or \*CLS command to the Calibrator. The ESE is cleared (set to 0) when the power is turned on.

**Bit Assignments for the ESR and ESE**

The bits in the Event Status Register (ESR) and Event Status Enable register (ESE) are assigned as shown in Figure 4-7.

15	14	13	12	11	10	9	8
0	0	0	0	0	0	0	0

7	6	5	4	3	2	1	0
<b>PON</b>	<b>0</b>	<b>CME</b>	<b>EXE</b>	<b>DDE</b>	<b>QYE</b>	<b>0</b>	<b>OPC</b>

PON	Power on. This bit is set to 1 if line power has been turned off and on since the last time the ESR was read.
CME	Command error. The 525A's IEEE-488 interface encountered an incorrectly formed command. (The command ERR? fetches the earliest error code in the error queue, which contains error codes for the first 15 errors that have occurred.)
EXE	Execution error. An error occurred while the 525A tried to execute the last command. This could be caused, for example, by a parameter being out of range. (The command ERR? fetches the earliest error in the error queue, which contains error codes for the first 15 errors that have occurred.)
DDE	Device-dependent error. An error related to a device-dependent command has occurred.
QYE	Query error. The 525A was addressed to talk when no response data was available or appropriate, or when the controller failed to retrieve data on the output queue.
OPC	Operation complete. All commands previous to reception of a *OPC command have been executed, and the interface is ready to accept another message.

ajr17f.eps

**Figure 4-7. Event Status Register (ESR) and Event Status Enable (ESE)**

### **Programming the ESR and ESE**

To read the contents of the ESR, send the remote command, \*ESR?. The ESR is cleared (set to 0) every time it is read. To read the contents of the ESE, send the remote command, \*ESE?. The ESE is not cleared when it is read. When you read either register, the Calibrator responds by sending a decimal number that when converted to binary represents bits 0 through 15.

### **Output Queue**

The output queue is loaded whenever a query is processed, and holds up to 250 characters. The controller reads it with a statement such as a BASIC INPUT statement, removing what it reads from the queue. If the queue is empty, the Calibrator does not respond to the INPUT statement from the controller. The Message Available (MAV) bit in the Serial Poll Status Byte is 1 if there is something in the output queue and 0 if the output queue is empty.

### **Error Queue**

When a command error, execution error, or device-dependent error occurs, its error code is placed in the error queue where it can be read by the ERR? command. (See Chapter 5 for a list of error messages.) Reading the first error with the ERR? command removes that error from the queue. A response of 0 means the error queue is empty. The error queue is cleared when you turn off the power, and when you use the \*CLS (Clear Status) common command.

The error queue contains up to 15 entries. If more than 15 errors occur, only the first 15 errors are kept in the queue. A 16th entry in the queue is always an "error queue overflow" error, and all later errors are discarded until the queue is at least partially read. The first errors are kept, because if many errors occur before the user can acknowledge and read them, the earliest errors are the most likely to point to the problem. The later errors are usually repetitions or consequences of the original problem.

### **Input Buffer Operation**

As the Calibrator receives each data byte from the controller, it places the bytes in a portion of memory called the input buffer. The input buffer holds up to 250 data bytes and operates in a first in, first out fashion.

**IEEE-488** The Calibrator treats the EOI IEEE-488 control line as a separate data byte and inserts it into the input buffer if it is encountered as part of a message terminator. Input buffer operation is transparent to the program running on the controller. If the controller sends commands faster than the Calibrator can process them, the input buffer fills to capacity. When the input buffer is full, the Calibrator holds off the IEEE-488 bus with the NRFD (Not Ready For Data) handshake line. When the Calibrator has processed a data byte from the full input buffer, it then completes the handshake, allowing the controller to send another data byte. The calibrator clears the input buffer on power-up and on receiving the DCL (Device Clear) or SDC (Selected Device Clear) messages from the controller.

**RS-232** Under RS-232-C serial port remote control using ^S (<Cntl> S) XOFF protocol, the Calibrator issues a ^S XOFF when the input buffer becomes 80% full. The calibrator issues a ^Q (<Cntl> Q) XON when it has read enough of the input buffer so that it is less than 40% full.





# Chapter 5

## Remote Commands

### Introduction

Remote commands duplicate activities that can be initiated from the front panel in local operation. Following the summary table is a complete alphabetical listing of all commands complete with protocol details. Separate headings in the alphabetical listing provide the parameters and responses, plus an example for each command. For information on using commands, see Chapter 4, “Remote Operation.”

### Command Summary by Function

#### Common Commands

Command	Description
*CLS	(Clear status.) Clears the ESR, the error queue, and the RQS bit in the status byte. This command terminates pending operation complete commands (*OPC or *OPC?).
*ESE	Loads a byte into the Event Status Enable register.
*ESE?	Returns the contents of the Event Status Enable register.
*ESR?	Returns the contents of the Event Status register and clears the register.
*IDN?	Identification query. Returns the manufacturer, model number, and firmware revision level of the Calibrator.
*OPC	Enables setting of bit 0 (OPC for "Operation Complete") in the Event Status Register to 1 when all pending device operations are complete.
*OPC?	Returns a 1 after all pending operations are complete. This command causes program execution to pause until all operations are complete. (See also *WAI.)

**Common Commands (continued)**

<b>Command</b>	<b>Description</b>
*OPT?	Returns a list of the installed hardware and software options.
*RST	Resets the state of the instrument to the power-up state. This command holds off execution of subsequent commands until it is complete. (Overlapped command.)
*SRE	Loads a byte into the Service Request Enable register (SRE).
*SRE?	Returns the byte from the Service Request Enable register.
*STB?	Returns the status byte.
*TST?	Initiates a series of self-tests, then returns a "0" for pass or a "1" for fail. If any faults are detected, they are logged into the fault queue where they can be read by the ERR? query.
*WAI	Prevents further remote commands from being executed until all previous remote commands have been executed.

**External Connection Commands**

<b>Command</b>	<b>Description</b>
PRES_UNIT	Sets the pressure display units.
PRES_UNIT?	Returns the pressure display units.
RTD_TYPE	Sets the Resistance Temperature Detector (RTD) type.
RTD_TYPE?	Returns the Resistance Temperature Detector (RTD) type.
TC_REF	Sets whether the internal temperature sensor or an external reference value is used for Thermocouple (TC) outputs and measurements.
TC_REF?	Returns the source being used as a reference for thermocouple simulation and measurements.
TC_TYPE	Sets the thermocouple (TC) temperature type.
TC_TYPE?	Returns the thermocouple (TC) type.
TSENS_TYPE	Sets temperature sensor type.
TSENS_TYPE?	Returns the temperature sensor type.

**Output Commands**

<b>Command</b>	<b>Description</b>
FUNC?	Returns the present output, measurement, or calibration function.
OPER	Activates the Calibrator output if it is in standby.
OPER?	Returns the operate/standby setting.
OUT	Sets the output of the Calibrator.
OUT?	Returns the output amplitude of the Calibrator.
RANGE?	Returns the present output range. (Voltage only).
RANGELCK	Locks the present output range (Voltage only).
RANGELCK?	Returns the RANGELOCK state (Voltage only).
STBY	Deactivates the Calibrator output if it is in Operate mode.

**Measurement Commands**

<b>Command</b>	<b>Description</b>
PRES?	Queries the attached pressure module for its model and serial number.
PRES_MEAS	Changes the operating mode to pressure measurement.
RTD_MEAS	Changes the operating mode to RTD measurement.
TC_MEAS	Changes the operating mode to thermocouple measurement.
VAL?	Returns the last resistance, temperature, or pressure measurement value.
ZERO_MEAS	Zeros the pressure module.
ZERO_MEAS?	Returns the zero offset for the pressure module.

**RS-232 Port Commands**

<b>Command</b>	<b>Description</b>
LOCAL	Puts the Calibrator into the local state and disables lockout.
LOCKOUT	Puts the Calibrator into the lockout state. This command duplicates the IEEE-488 LLO (Local Lockout) message.
REMOTE	Puts the Calibrator into the remote state. This command duplicates the IEEE-488 REN (Remote Enable) message.

**Status Commands**

Command	Description
ERR?	Returns the first error code in the Calibrator error queue, then removes that error code from the queue.

**Error Code Listing**

Error Number	Message Class	Description
1	DDE	Error queue overflow.
100	EXE	OPER or STBY was received when the 525A is in Measure mode or TC Source mode.
101	CME	A non-numeric entry was received in a field that should contain a numeric entry.
102	EXE	The numeric field exceeds 10 characters.
103	CME	Invalid units symbol or prefix.
104	EXE	An attempt to enter RTD Source mode was made when SPRT is selected.
105	EXE	Entry is above upper limit for the selected output range.
106	EXE	Entry is below lower limit for the selected output range.
107	EXE	Operate not allowed when >30 V and error is pending.
108	CME	A required command parameter was missing.
109	CME	An invalid TC_MEAS or RTD_MEAS unit parameter (not CEL or FAR) was received, or an invalid PRES_UNIT parameter was received.
110	CME	An invalid RANGELCK parameter (not ON or OFF) was received.
111	EXE	RANGELCK ON was received when the 525A is not in Volts mode.
112	CME	An invalid RTD_TYPE parameter was received.
113	CME	An invalid TC_REF parameter (not INT or EXT) was received.
114	CME	An invalid TSENS_TYPE parameter (not TC or RTD) was received.
116	EXE	ZERO_MEAS command error. Not allowed or too many parameters..
117	CME	An unrecognizable command was received.

**Error Code Listing (continued)**

Error Number	Message Class	Description
118	CME	An invalid parameter was received.
120	EXE	The serial input buffer overflowed
121	EXE	The command string buffer overflowed.
122	QYE	The serial output buffer overflowed.
123	DDE	The output overloaded.
124	DDE	525A is out of tolerance. This error is set after a failed initialization or a failed *TST?.
125	DDE	525A has a ADC failure. This error is set after a failed initialization or a failed *TST?.

**Remote Command Listing**

The following is an alphabetical list of all Calibrator commands and queries, including common commands and device-dependent commands. Each command title includes a graphic that indicates remote interface applicability, IEEE-488 and RS-232, and command group: Sequential and Overlapped.

**IEEE-488 (GPIB) and RS-232 Applicability**      IEEE-488      RS-232

Each command and query has a check box indicating applicability to IEEE-488 (general purpose interface bus, or GPIB) and RS-232 remote operations. For sorting purposes, this list ignores the \* character that precedes the common commands.

**Sequential Commands**      Sequential     Commands executed immediately as they are encountered in the data stream are called sequential commands. For more information, see “Sequential Commands” in Chapter 4.

**Overlapped Commands**      Overlapped     Commands that require additional time to execute are called overlapped commands because they can overlap the next command before completing execution. To be sure an overlapped command is not interrupted during execution, use the \*OPC, \*OPC?, and \*WAI commands to detect command completion. For more information, see “Overlapped Commands” in Chapter 4.

---

**\*CLS**  IEEE-488  RS-232  Sequential  Overlapped

(Clear Status command) Clears the ESR, the error queue, and the RQS bit in the status byte. This command terminates pending operation complete commands (\*OPC or \*OPC?).

Parameter: (None)

Example: \*CLS

Clear the ESR, the error queue, and the RQS bit in the status byte.

---

**\*ESE**  IEEE-488  RS-232  Sequential  Overlapped

(Event Status Enable command) Loads a byte into the Event Status Enable (ESE) register. (See “Event Status Enable Register (ESE)” in Chapter 4)

Parameter: <value> (decimal equivalent of the ESE byte, 0 to 255)

Example: \*ESE 140

Load decimal 140 (binary 10001100) to enable bits 7 (PON), 3 (DDE) and 2 (QYE).

---

**\*ESE?**  IEEE-488  RS-232  Sequential  Overlapped

(Event Status Enable query) Returns the contents of the Event Status Enable (ESE) register. (See “Event Status Enable Register (ESE)” in Chapter 4)

Response: <value> (decimal equivalent of the ESE byte, 0 to 255)

Example: \*ESE? returns 133

Returns decimal 133 (binary 10000101) when bits 7 (PON), 2 (QYE), 1 (OPC) are enabled.

**\*ESR?**  IEEE-488  RS-232  Sequential  Overlapped

(Event Status Register query) Returns the contents of the Event Status Register (ESR) and clears the register. (See Event Status Register (ESR)” in Chapter 4)

Response: <value> (decimal equivalent of the ESR byte, 0 to 255)

Example: \*ESR? returns 189

Returns decimal 189 (binary 00111101) when bits 5 (CME), 4 (EXE), 3 (DDE), 2 (QYE) and 0 (OPC) are enabled.

---

**FUNC?**  IEEE-488  RS-232  Sequential  Overlapped

(Function query) Returns the present output, measurement, or calibration function. See the response below for output and measurement modes.

Responses:

DCV	(dc volts function)
DCI	(dc current function)
RTD_OUT	(source temperature with an RTD function)
RTD_IN	(read temperature with an RTD function)
TC_OUT	(source temperature with a thermocouple function)
TC_IN	(read temperature with a thermocouple function)
PRESSURE	(read pressure)

Example: FUNC? returns DCV

Returns DCV when the Calibrator output function dc volts.

---

**\*IDN?**  IEEE-488  RS-232  Sequential  Overlapped

(Identification query) Returns instrument model number, serial number, and firmware revision levels for the main, encoder, and inguard CPUs.

Responses: (Indefinite ASCII) A message containing four fields separated by commas as follows:

1. Manufacturer
2. Model number
3. Serial number (always 0)
4. Firmware revision levels for the main, front panel, and inguard CPUs.

Example: \*IDN? returns FLUKE,525A,0,1.2

Returns Fluke manufacturer, model 525A, serial number 0, firmware version 1.2.

---

**LOCAL**    IEEE-488    RS-232    Sequential    Overlapped

(Local command) Puts the Calibrator into the local state, clearing the remote state (see the REMOTE command) and front panel lockout (see the LOCKOUT command). This command duplicates setting the IEEE-488 REN line to false.

Parameter:   (None)

Example:   LOCAL

Set the instrument into the local state, clearing the remote state and front panel lockout (if enabled).

---

**LOCKOUT**    IEEE-488    RS-232    Sequential    Overlapped

(Lockout command) Puts the Calibrator into the lockout state when in remote control (see the REMOTE command). This means no local operation at the front panel is allowed during remote control. To clear the lockout condition, use the LOCAL command. This command duplicates the IEEE-488 LLO (Local Lockout) message.

Parameter:   (None)

Example:   LOCKOUT

Set the instrument into the front panel lockout state. The front panels controls cannot be used.

---

**\*OPC**    IEEE-488    RS-232    Sequential    Overlapped

(Operations Complete command) Sets bit 0 (OPC) of the Event Status Register to 1 when all pending device operations are complete. Also see the \*ESR? command.

Parameter:   (None)

Example:   \*OPC

Set bit 0 of the Event Status Register to 1 when all pending device operations are done.



**\*OPC?**  IEEE-488  RS-232  Sequential  Overlapped

(Operations Complete query) Returns a 1 after all pending operations are complete. This command causes program execution to pause until operations are complete. (See \*WAI.)

Response: 1 (all operations are complete)

Example: \*OPC? returns 1

Returns 1 when all pending operations are complete.

---

**OPER**  IEEE-488  RS-232  Sequential  Overlapped

(Operate command) Activates the Calibrator output if it is in standby. This is the same as pressing the Calibrator front panel  key.

Parameter: (None)

Example: OPER

Connect the selected output to the Calibrator front panel terminals. Also indicates OPR on the display.

---

**OPER?**  IEEE-488  RS-232  Sequential  Overlapped

(Operate query) Returns the operate/standby setting.

Response: 1 (Operate)  
0 (Standby)

Example: OPER? returns 1

Returns 1 when the Calibrator is in operate.

---

**\*OPT?**  IEEE-488  RS-232  Sequential  Overlapped

(Options command) Returns a list of the installed hardware and software options.

Responses: <option string>, <option string>, (options list, separated by commas)  
0 (no options are installed)

Example: \*OPT? Returns 0

This command is reserved for future use.

**OUT**  IEEE-488  RS-232  Sequential  Overlapped

(Output command) Sets the output of the Calibrator and establishes a new reference point for the error mode. To source or measure a temperature, select the desired sensor and sensor parameters first. (See the TSENS\_TYPE, RTD\_TYPE, and TC\_TYPE commands.)

Use multipliers, k, m, u with the OUT command, as desired.

Parameters: <value> V                      Volts dc  
<value> A                                Current dc  
<value> OHM                              Resistance  
<value> CEL                              Temperature (Celsius)  
<value> FAR                              Temperature (Fahrenheit)

Examples:    OUT 15.2 V                      (volts; 15.2 V)  
              OUT 1.2 mA                    (current; 1.2 mA)  
              OUT 5 Ohm                    (ohms; 5  $\Omega$ )  
              OUT 100 CEL                 (temperature; 100  $^{\circ}$ C)  
              OUT -32 FAR                 (temperature; -32 $^{\circ}$ F)

Each example shows a value and unit, e.g., -15.2 V. If a value is entered without a unit, the value of the existing output is changed, when logically allowed.

---

**OUT?**  IEEE-488  RS-232  Sequential  Overlapped

(Output query) Returns the output amplitude of the Calibrator. Multipliers (e.g., K or M) are not used in the response.

Response:    <amplitude value>,<units>

Examples:    OUT? returns -1.520000E+01,V  
              OUT? returns 1.88300E-02,A  
              OUT? returns 1.23000E+00,V  
              OUT? returns 4.00000E+03,OHM  
              OUT? returns 1.52000E+01,V  
              OUT? returns 1.0430E+02,CEL

The respective values for the above examples are:

-15.2 V  
18.83 mA  
1.23 V  
4 K $\Omega$   
15.2 V  
104.3  $^{\circ}$ C

**PRES?**    IEEE-488    RS-232    Sequential    Overlapped

(Pressure Module query) Queries the attached pressure module for its model and serial number.

Responses: (Indefinite ASCII) A message containing four fields separated by commas as follows:

1. Manufacturer
2. Model number
3. Serial number
4. Firmware revision (0)

Example: FLUKE,700P05,9467502,0

---

**PRES\_MEAS**    IEEE-488    RS-232    Sequential    Overlapped

(Pressure Measurement mode command) Changes the operating mode to pressure measurement.

Example:    PRES\_MEAS

Changes the Operating mode to pressure measurement.

---

**PRES\_UNIT**    IEEE-488    RS-232    Sequential    Overlapped

(Pressure Units command) Sets the pressure display units.

Parameters:

PSI	(pounds per square inch)
INH204C	(inches of water at 4 degrees Celsius)
INH2020C	(inches of water at 20 degrees Celsius)
CMH204C	(centimeters of water at 4 degrees Celsius)
CMH2020C	(centimeters of water at 20 degrees Celsius)
BAR	(bars)
MBAR	(millibars)
KPAL	(kilopascals)
INHG	(inches of mercury)
MMHG	(millimeters of mercury)
KG/CM2	(kilograms per square centimeter)

Example:    PRES\_UNIT BAR

---

**PRES\_UNIT?**  IEEE-488  RS-232  Sequential  Overlapped

(Pressure Units query) Returns the pressure display units.

Responses:   PSI                   (pounds per square inch)  
              INH2O4C           (inches of water at 4 degrees Celsius)  
              INH2O20C         (inches of water at 20 degrees Celsius)  
              CMH2O4C          (centimeters of water at 4 degrees Celsius)  
              CMH2O20C         (centimeters of water at 20 degrees Celsius)  
              BAR               (bars)  
              MBAR             (millibars)  
              KPAL             (kilopascals)  
              INHG             (inches of mercury)  
              MMHG             (millimeters of mercury)  
              KG/CM2          (kilograms per square centimeter)

Example:     PRES\_UNIT? returns BAR

---

**RANGE?**  IEEE-488  RS-232  Sequential  Overlapped

(Range query) Returns the present voltage output range.

Response:    <range>

Examples:    V\_0.1V           (dc volts 100 mV range)  
              V\_1V            (dc volts 1V range)  
              V\_10V           (dc volts 10 V range)  
              V\_100V          (dc volts 100 V range)

Returns the symbolic name of the voltage output range.

---

**RANGELCK**  IEEE-488  RS-232  Sequential  Overlapped

(Range lock command) Locks or unlocks the present voltage range.

Parameter:   ON   Locks the present voltage range  
              OFF  Unlocks the present voltage range.

**RANGELCK?**  IEEE-488  RS-232  Sequential  Overlapped

(Range command) Returns the RANGELOCK state 1 for ON or 0 for OFF.

Parameter: (None)

**REMOTE**  IEEE-488  RS-232  Sequential  Overlapped

(Remote command) Places the Calibrator into the remote state. This command duplicates the IEEE-488 REN (Remote Enable) message. When the Calibrator is in the remote state, and not locked out, only the LOCAL key is active. If the front panel is locked out, no front panel keys are active. See the LOCKOUT command. To unlock the front panel, use the LOCAL command, or cycle the Calibrator power switch.

Parameter: (None)

Example: REMOTE

**\*RST**  IEEE-488  RS-232  Sequential  Overlapped

(Reset Instrument command) Resets the Calibrator to the power-up state. \*RST holds off execution of subsequent commands until the reset operation is complete.

A reset action evokes the following commands and values:

Command	Value
OUT	0 V
PRES_UNIT	Last selected
RANGE	0.1 V
RTD_TYPE	Last selected
STBY	(No output)
TC_REF	INT
TC_TYPE	Last selected
TSENS_TYPE	Last selected

Response: (None)

Example: \*RST

Place the Calibrator in a reset condition, evoking the commands and values shown above.

---

**RTD\_MEAS**  IEEE-488  RS-232  Sequential  Overlapped

(RTD Measure command) Selects the measure RTD mode.

Parameters: CEL (Celsius) (optional)  
FAR (Fahrenheit) (optional)

Example: RTD\_MEAS CEL

Measure the RTD temperature that is attached to the Calibrator RTD terminals, in Celsius.

---

**RTD\_TYPE**  IEEE-488  RS-232  Sequential  Overlapped

(Resistance Temperature Detector Type command) Sets the Resistance Temperature Detector (RTD) sensor type.

Before using RTD\_TYPE, select RTD using the TSENS\_TYPE command. After using RTD\_TYPE, select the output temperature using the OUT command. Changes in temperature sensors changes the output to 0 °C. Once set, the Calibrator retains the RTD type until power off or reset.

Parameters: PT385\_100 (100-ohm RTD, curve  $\alpha=0.00385$  ohms/ohm/°C)  
PT385\_200 (200-ohm RTD, curve  $\alpha=0.00385$  ohms/ohm/°C)  
PT385\_500 (500-ohm RTD, curve  $\alpha=0.00385$  ohms/ohm/°C)  
PT385\_1000 (1000-ohm RTD, curve  $\alpha=0.00385$  ohms/ohm/°C)  
PT392\_100 (100-ohm RTD, curve  $\alpha=0.003926$  ohms/ohm/°C)  
PTJIS\_100 (100-ohm RTD, curve  $\alpha=0.003916$  ohms/ohm/°C)  
CU10 (10-ohm RTD, empirical curve)  
NI120 (120-ohm RTD, empirical curve)  
YSI\_400 (YSI thermistor curve)  
OHMS\_HIGH (4000 ohms range)  
OHMS\_LOW (400 ohms range)  
SPRT\_25 (25 ohm standard PRT with user defined error coefficients)  
USR\_DEF<x> (RTD with user defined coefficients (x from 1 to 5))

Example: RTD\_TYPE PTJIS\_100

Set the RTD type to a 100-ohm type, using the PT3926 curve ( $\alpha=0.003926$  ohms/ohm/°C). The resistance of 100 ohms refers to the ice point characteristic, (the resistance of the RTD at 0 °C (32 °F)).

**RTD\_TYPE?**  IEEE-488  RS-232  Sequential  Overlapped

(Resistance Temperature Detector Type query) Returns the Resistance Temperature Detector (RTD) type used for RTD temperature simulations.

Responses:

PT385_100	(100-ohm RTD, curve $\alpha=0.00385$ ohms/ohm/°C)
PT385_200	(200-ohm RTD, curve $\alpha=0.00385$ ohms/ohm/°C)
PT385_500	(500-ohm RTD, curve $\alpha=0.00385$ ohms/ohm/°C)
PT385_1000	(1000-ohm RTD, curve $\alpha=0.0038$ ohms/ohm/°C)
PT392_100	(100-ohm RTD, curve $\alpha=0.003926$ ohms/ohm/°C)
PTJIS_100	(100-ohm RTD, curve $\alpha=0.003916$ ohms/ohm/°C)
CU10	(10-ohm RTD, empirical curve)
NI120	(120-ohm RTD, empirical curve)
YSI_400	(YSI thermistor curve)
OHMS_HIGH	(4000 ohms range)
OHMS_LOW	(400 ohms range)
SPRT_25	(25 ohm standard PRT with user defined error coefficients)
USR_DEF<x>	(RTD with user defined coefficients (x from 1 to 5))

Example: RTD\_TYPE? returns PTJIS\_100

Returns PTJIS\_100 when a 100-ohm RTD with curve  $\alpha=0.3926$  ohm/°C is set as the RTD type.

---

**\*SRE**  IEEE-488  RS-232  Sequential  Overlapped

(Service Request Enable command) Loads a byte into the Service Request Enable (SRE) register. (See “Service Request Enable Register (SRE)” in Chapter 4. Since bit 6 is not used (decimal value 64), the maximum entry is  $255 - 64 = 191$ .)

Parameter: <value> (the decimal equivalent of the SRE byte, 0 to 191)

Example: \*SRE 48

Enable bits 4 (MAV), and 5 (ESR).

---

**\*SRE?**  IEEE-488  RS-232  Sequential  Overlapped

(Service Request Enable query) Returns the byte in the Service Request Enable (SRE).

Response: <value> (the decimal equivalent of the SRE byte, 0 to 191)

Example: \*SRE? returns 48

Returns 48 when bits 4 (MAV), and 5 (ESR) are enabled.

---

**\*STB?**  IEEE-488  RS-232  Sequential  Overlapped

(Status Byte Register query) Returns the byte for the Status Byte Register. See “Status Byte Register (STB)” in Chapter 4.

Response: <value> (the decimal equivalent of the STB byte, 0 to 255)

Example: \*STB? returns 96

Returns 96 if bits 5 (ESR) and 6 (MSS) are set.

---

**STBY**  IEEE-488  RS-232  Sequential  Overlapped

(Standby command) Deactivates the Calibrator output if it is in operate. This is the same as pressing the Calibrator front panel  key.

Parameter: (None)

Example: STBY

Disconnect the selected output from the Calibrator front panel terminals.

---

**TC\_MEAS**  IEEE-488  RS-232  Sequential  Overlapped

(Thermocouple Measure command) Selects the measure thermocouple mode.

Parameters: CEL (Celsius) (optional)  
FAR (Fahrenheit) (optional)

Example: TC\_MEAS CEL

Measure the thermocouple temperature that is attached to the Calibrator TC terminals, in Celsius.



**TC\_REF**  IEEE-488  RS-232  Sequential  Overlapped

(Thermocouple Reference command) Sets whether the internal temperature sensor (INT) or an external reference value (EXT) is used for Thermocouple (TC) outputs and measurements. The Calibrator retains the TC reference setting until power off or reset.

Parameters: INT  
EXT

Example: TC\_REF EXT

Set the thermocouple reference to external.

---

**TC\_REF?**  IEEE-488  RS-232  Sequential  Overlapped

(Thermocouple Reference query) Returns the source of the temperature being used as a reference for thermocouple simulation and measurement. The choices are Internal reference (INT) or External reference (EXT).

Responses: INT  
EXT

Example: TC\_REF? returns INT

Returns Internal.

**TC\_TYPE**  IEEE-488  RS-232  Sequential  Overlapped

(Thermocouple Type command) Sets the Thermocouple (TC) temperature sensor type. The TC type is used when the output is set to a temperature value with the OUT command and the temperature sensor type is set to TC with the TSENS\_TYPE command. When the thermocouple type is changed while simulating a temperature output, the temperature is changed to 0 °C. The Calibrator retains the TC type until power off or reset.

Parameters: B (B-type thermocouple)  
C (C-type thermocouple)  
E (E-type thermocouple)  
J (J-type thermocouple)  
K (K-type thermocouple)  
L (L-type thermocouple)  
N (N-type thermocouple)  
R (R-type thermocouple)  
S (S-type thermocouple)  
T (T-type thermocouple)  
Z (1 mV/°C linear output)

Example: TC\_TYPE J

Set the thermocouple type for simulating a temperature output to a J-type thermocouple.

**TC\_TYPE?**  IEEE-488  RS-232  Sequential  Overlapped

(Thermocouple Type query) Returns the Thermocouple (TC) temperature sensor type. When the thermocouple type is changed while simulating a temperature output, the temperature is changed to 0 °C.

Responses:    B        (B-type thermocouple)  
                   C        (C-type thermocouple)  
                   E        (E-type thermocouple)  
                   J        (J-type thermocouple)  
                   K        (K-type thermocouple)  
                   L        (L-type thermocouple)  
                   N        (N-type thermocouple)  
                   R        (R-type thermocouple)  
                   S        (S-type thermocouple)  
                   T        (T-type thermocouple)  
                   Z        (1 mV/°C linear output)

Example:    TC\_TYPE? returns K

Returns K when the thermocouple type for simulating a temperature output is a K-type thermocouple.

---

**TSENS\_TYPE**  IEEE-488  RS-232  Sequential  Overlapped

(Temperature Sensor Type command) Sets the temperature sensor type to thermocouple (TC) or Resistance Temperature Detector (RTD) for temperature measurements.

Parameters: TC        (Thermocouple)  
                   RTD       (Resistance Temperature Detector)

Example:    TSENS\_TYPE RTD

Set the temperature sensor type to an RTD.

**TSENS\_TYPE?**  IEEE-488  RS-232  Sequential  Overlapped

(Temperature Sensor Type query) Returns the temperature sensor type thermocouple (TC) or Resistance Temperature Detector (RTD) for temperature measurements.

Responses: TC (Thermocouple)  
RTD (Resistance Temperature Detector)

Example: TSENS\_TYPE? returns TC

Returns TC when the temperature sensor type is a thermocouple.

**\*TST?**  IEEE-488  RS-232  Sequential  Overlapped

(Self Test command) Initiates self-test and returns a 0 for pass or a 1 for fail. If any faults are detected, they are displayed on screen (Terminal mode) or are logged into the fault queue where they can be read by the ERR? query (Computer mode).

Responses: 0 (pass self test)  
1 (fail self test)

Example: \*TST? returns 1

Returns 1 when self test fails.

**VAL?**  IEEE-488  RS-232  Sequential  Overlapped

(Measurement Value command) Returns the last value of the resistance, temperature, or pressure measurement. The second parameter returned is either the units of the measurement or an indication that an error occurred.

Responses: 1. (Float) Measured resistance, temperature, or pressure  
2. (Character) CEL, FAR, OHM, PSI, INH2O4C, INH2O20C, CMH2O4C, CMH2O20C, BAR, MBAR, KPA, INHG, MMHG, KG/CM2  
OVER (value is over or under capability),  
NONE (not in a measurement mode)

Example: VAL? returns 0.000000E+00,NONE

Returns 0 and NONE when the Calibrator is not in a measurement mode.

**\*WAI**  IEEE-488  RS-232  Sequential  Overlapped

(Wait-to-Continue command) Prevents further remote commands from being executed until all previous remote commands have been executed. For example, if you send an OUT command, you can cause the Calibrator to wait until the output has settled before continuing on to the next command if you follow OUT with a \*WAI command. The \*WAI command is useful with any overlapped command, preventing the Calibrator from processing other commands until the overlapped command is processed.

Example: \*WAI

Process all existing commands before continuing.

---

**ZERO\_MEAS**  IEEE-488  RS-232  Sequential  Overlapped

(Zero Measure command) Zeros the pressure module and the TC mV offset. See Chapter 3 for the TC mV zero calibration procedure.

Parameters: <value> in current pressure units for absolute pressure modules.

Example: ZERO\_MEAS

---

**ZERO\_MEAS?**  IEEE-488  RS-232  Sequential  Overlapped

(Zero Measure query) Returns the zero offset for absolute pressure modules.

Response: <zero offset>,<units>

Example: ZERO\_MEAS? returns -1.520000E+00,PSI



# Chapter 6

## ***Maintaining the Calibrator***

### ***Maintenance***

#### ***Cleaning the Calibrator***

##### **⚠ Warning**

**To avoid personal injury or damage to the Calibrator, use only the specified replacement parts and do not allow water into the case.**

##### **⚠ Caution**

**To avoid damaging the case, do not use solvents or abrasive cleaners.**

Clean the Calibrator and pressure modules with a soft cloth dampened with water or mild soap and water.

#### ***Replacing a Line Fuse***

##### **⚠ Warning**

**To avoid electrical shock hazard disconnect line power before opening the case or line voltage selector.**

The line power fuses and line voltage selector switch are located in a compartment above the power switch on the right rear of the Calibrator. The fuse rating label on the rear panel shows the correct replacement fuse for each line voltage setting.

Table 6-1 lists the fuse part numbers for each line voltage setting. Figure 6-1 shows how to remove the fuse compartment cover.

**To check or replace a fuse**

1. Disconnect line power.
2. Using the blade of a standard screwdriver, pry the tab at the base of the line fuse compartment. The compartment cover will pop part way out.
3. Remove the compartment cover. The fuses come out with the compartment cover and can easily be checked or replaced.
4. To reinstall the fuse, push the compartment cover back into the compartment until the tab locks in place.

*Note*

*When changing the line voltage setting, you will need to verify that the appropriate line fuse is installed in the Calibrator. Replace the fuse as required.*

**Table 6-1. Replacement Fuses**

Part Number	Fuse Description	Line Voltage Setting
△ 1645311	0.25 A/250 V fast	120 V (90 V to 132 V)
△ 1645327	0.125 A/250 V fast	240 V (198 V to 264 V)

**Changing Line Voltage**

The Calibrator arrives from the factory configured for the line voltage appropriate for the country of purchase or as specified when it is ordered. To verify the line voltage setting, check the line voltage indicator on the power line fuse compartment cover.

*Note*

*Confirm that the line voltage selection is set for 120 V for line voltages between 90 V and 132 V or that the selector is set to 240 V for line voltages between 198 V and 264 V.*

**To change the line voltage**

1. Disconnect line power.
2. Using the blade of a standard screwdriver, pry the tab at the base of the line fuse compartment. The compartment cover will pop part way out.
3. Remove the compartment cover.
4. Remove the line voltage selector assembly by gripping the line voltage indicator tab with pliers and pulling it straight out of the compartment.
5. Rotate the line voltage selector assembly to the desired voltage and reinsert.



- Verify you are using the appropriate fuse for the selected line voltage (See Table 6-1) and reinstall the fuse compartment by pushing it in until the tab locks in place.

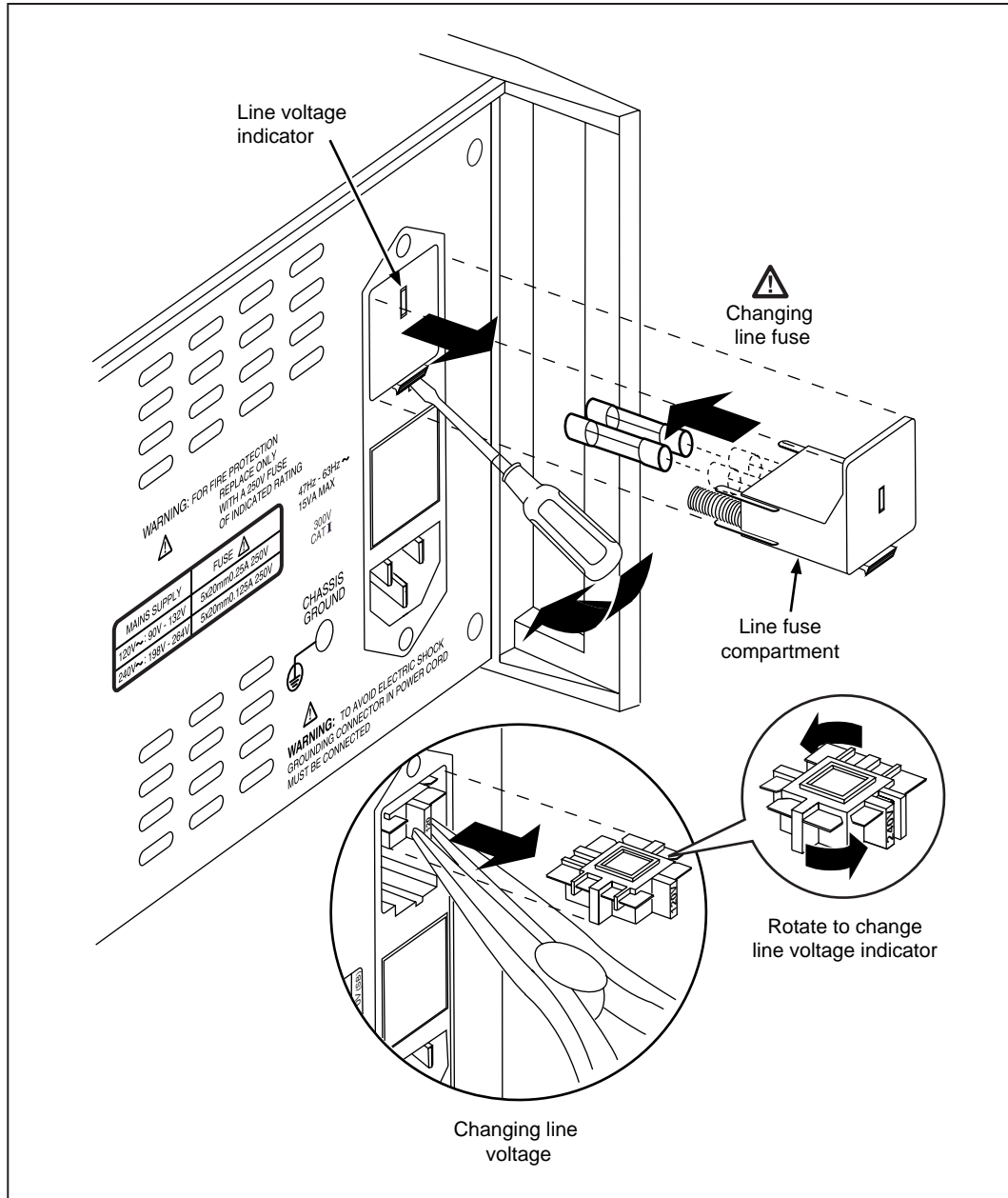

Figure 6-1. Accessing the Fuse

ajr12f.eps

## Performance Tests

### Required Equipment List

Table 6-2. Required Equipment

Equipment	Recommended model	Purpose
8-1/2 digit Precision Digital Multimeter	Wavetek 1281 w/option 20 (ohms converter)	DC volts, resistance
Resistance standard	Fluke 742A-1	DC Current
Resistance standard	Fluke 742A-1K	Resistance
Resistance standard	Fluke 742A-10K	Resistance
Multifunction calibrator	Fluke 5520A	Resistance
Pressure module	Any Fluke 700 series module	Pressure
Lead set	5520A — 525A Leads kit	Provide test cables
Precision thermometer	ASTM56C	Measure temperature

**Testing DC Voltage**

The DC voltage amplitude accuracy test verifies the accuracy of DC voltage at the 525A calibrator front panel Volts Source output.

Range	Nominal Value (V)	Measured Value	Deviation %	90 Day Spec. (V)	One Year Spec. (V)
100 mV	0			0.000003	0.000003
	0.025			3.63E-06	3.75E-06
	0.075			4.88E-06	5.25E-06
	0.1			5.5E-06	0.000006
1.0 V	0			0.00002	0.00002
	0.25			2.63E-05	2.75E-05
	0.75			3.88E-05	4.25E-05
	1			0.000045	0.00005
10.0 V	0			0.0002	0.0002
	2.5			0.000263	0.000275
	7.5			0.000388	0.000425
	10			0.00045	0.0005
100.0 V	0			0.002	0.002
	25			0.002625	0.00275
	75			0.003875	0.00425
	100			0.0045	0.005

### Testing DC Current

Use the Wavetek 1281 and the precision shunt to measure the 525A output as shown in Figure 6-2 . Take the Voltage reading from the Wavetek 1281 and divide it by the 742A-1 actual value.

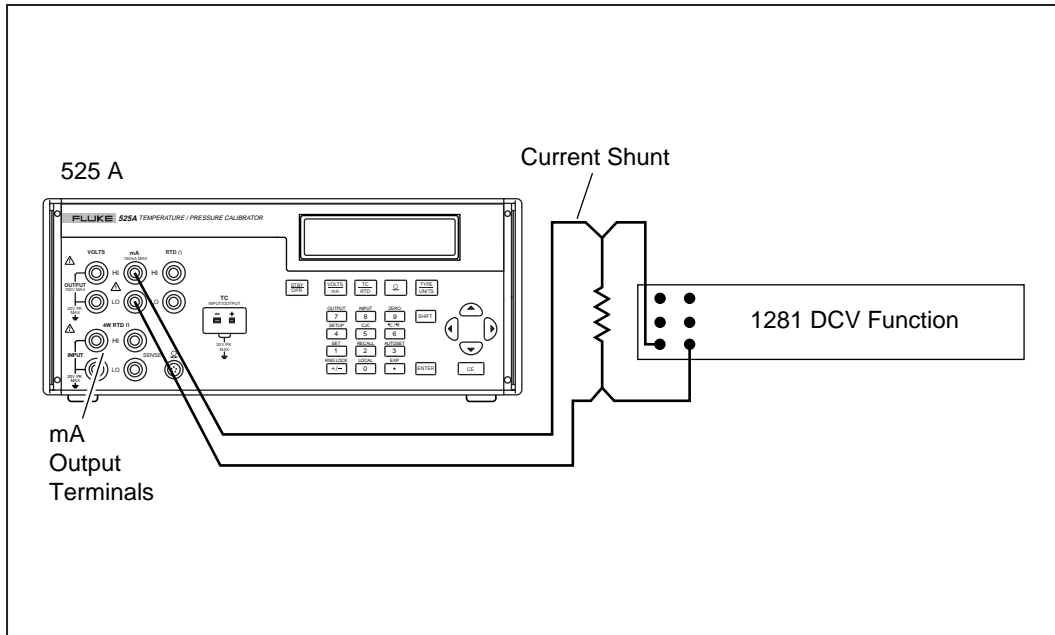

ajr25f.eps

Figure 6-2. Measuring DC Current

Table 6-3. Measuring DC Current

100 mA output (A)	Volt	Curent ( $I=E/R$ )	742A-1 Shunt Value	1 Year (A)
0			Direct into 1281 current input	0.000002
0.025				4.5E-06
0.075				9.5E-06
0.1				0.000012

### Testing Thermocouple Output

The first section of this test is to check the accuracy of the thermocouple output with K-type selected. The second section will be used with CJC on and a K-type thermocouple in a lag bath.

For this test, the CJC (cold junction compensation) must be turned off and the leads and mini-connector must be copper and copper. Press **SHIFT** **5** to turn off the CJC. XCJC on the display indicates that the CJU is turned off. The mini-connector will have the designation “Cu” for copper and copper. Connect the mini-connector to the front of the 525A TC input/output connector and the other end to the Wavetek 1281 DC voltage input. See Figure 6-3 for a connection diagram. Output the simulated thermocouple temperatures listed in Table 6.4.

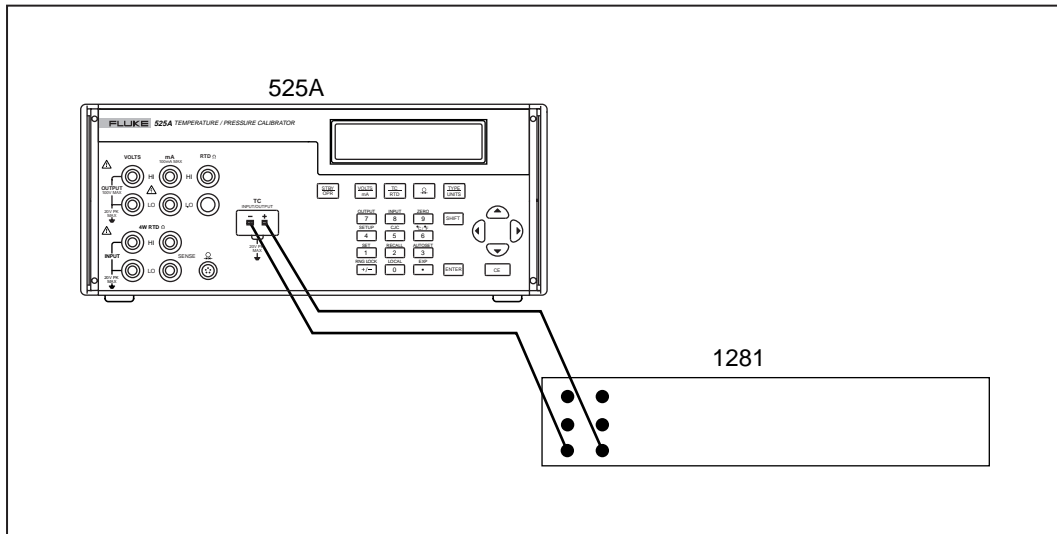

ajr26f.eps

Figure 6-3. Testing TC Output

Table 6-4. TC Temperatures

Temperature (°C)	Nominal Voltage (mV)	90 Day Spec (mV)	1 Year Spec. (mV)
-200	-5.891	0.0047	0.0047
-100	-3.554	0.0061	0.0061
-25	-.968	0.0068	0.0068
120	4.92	0.0081	0.0081
1000	41.276	0.0089	0.0094

### CJC (cold junction compensation) Calibration

Connect a Type-J thermocouple to the TC terminals on the Calibrator, and immerse the thermocouple and a precision thermometer in a mineral oil lag bath. The test setup is shown in Figure 6-4. Verify the reading of the thermometer and the Calibrator are within the thermocouple specifications listed in Chapter 7.

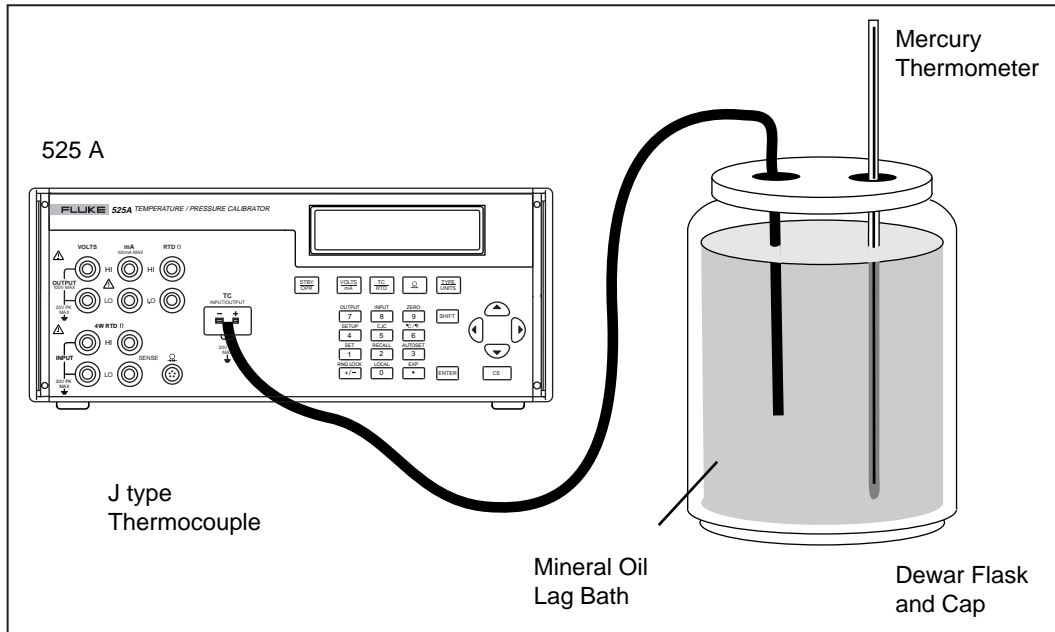

ajr22f.eps

Figure 6-4. Connections for CJC Calibration

### Testing Thermocouple Input

For this test the CJC (cold junction compensation) must be turned off and the leads and mini-connector must be copper and copper. Press **SHIFT** **5** to turn off the CJC. XCJC on the display indicates that the CJU is turned off. The mini-connector will have the designation “Cu” for copper and copper. Connect the mini-connector to the front of the 525A TC input/output connector and the other end to the 5520A DC voltage output. See Figure 6-5. Output the simulated thermocouple temperatures listed in Table 6-4.

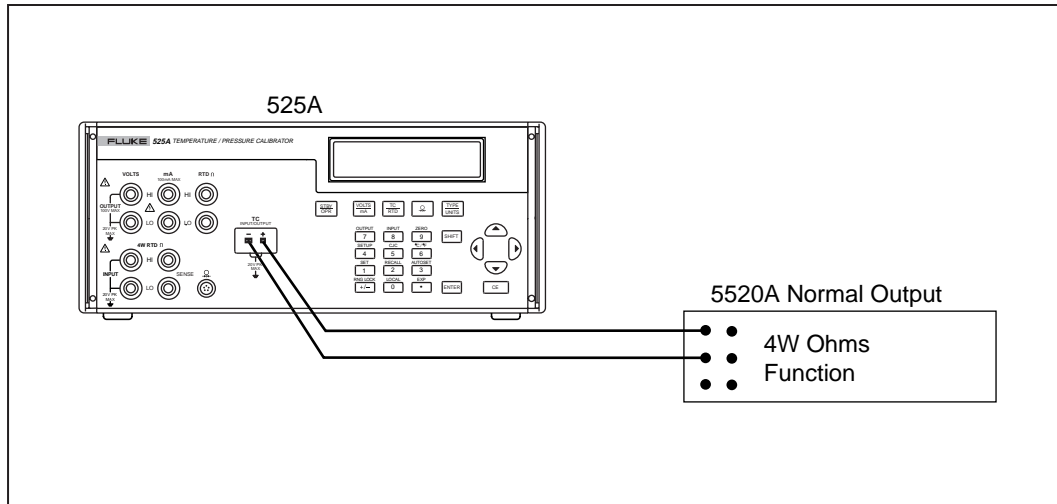

ajr24f.eps

Figure 6-5. Connections for Measuring TC Input

## Testing Ohms Output

Use the precision DMM to measure the resistance output. Figure 6-6 shows the four-wire connections. Set the DMM to the “TRU OHMS” setting. See the 1281 Operators Manual for information on using the “TRU OHM” setting.

### Note

*The Wavetek 1281 must be in the “loI” (low current mode) when measuring 5 ohms in the 4 K ohm range or an overload will occur.*

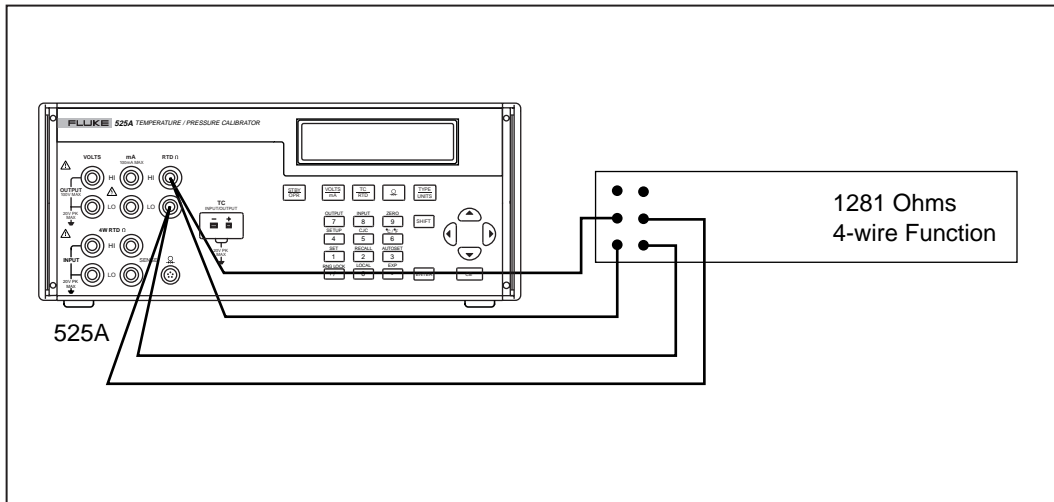

ajr23f.eps

Figure 6-6. Connection for Measuring Resistance Output

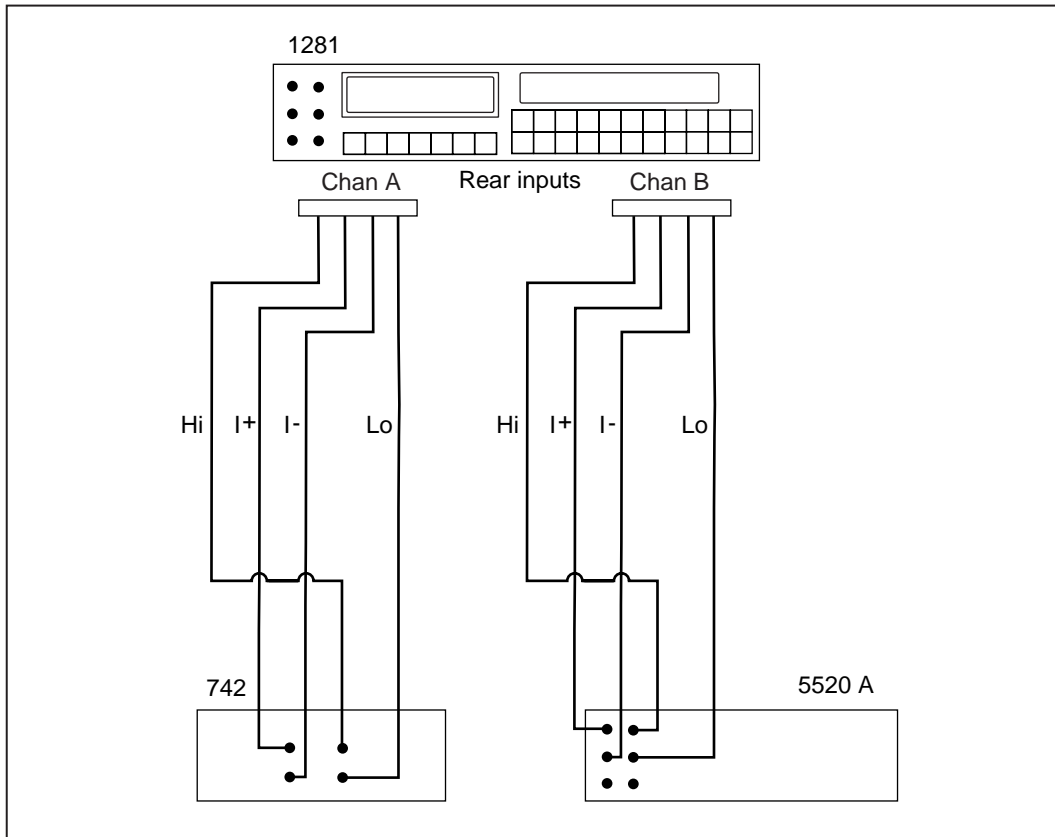

**Table 6-5. Ohms Output Ranges**

<b>Range (<math>\Omega</math>)</b>	<b>Output (<math>\Omega</math>)</b>	<b>1 Year (<math>\Omega</math>)</b>
<b>400</b>	5	0.03
	100	
	200	0.03
	300	0.03
	400	0.03
<b>4000</b>	5	0.3
	1000	
	2000	0.3
	3000	0.3
	4000	0.3

## Testing Ohms Input

Before measuring ohms input, you need to “characterize” the ohms output of a 5520A. To achieve the needed accuracy, the Wavetek 1281 will be used as a transfer standard and the 742A will be used as the reference standard. To find the true value of the 5520A output, the ratio input function of the Wavetek 1281 will be used. The ratio function of the 1281 is located on the rear panel and is designated as Channel A and Channel B. Connect Channel A to the 742A and connect the 5520A to Channel B, both using four-wire measure. See Figure 6-7 for a connection diagram.



ajr28f.eps

Figure 6-7. 1281 Connection Diagram

For the 400 ohm range use the 742A-1K and for the 4K ohm range use the 742A-10K. For more information on the correct usage of ratio mode refer to the 1281 Operators Manual. Use Table 6-8 to note the ratio indication on the 1281. Ignore the 0 ohm value. Use the formula (742A actual value/ratio indication \* 100 = actual 5520A value) and enter that ohm value into the 5520A actual value column.

**Table 6-6. Ohms Ratio Table**

Range (Ω)	742A Value (Ω)	Ratio	5520A Actual Value (Ω)	525A Reading	Spec.
<b>400</b>					
0					0.002
100					0.006
200					0.01
300					0.014
400					0.018
<b>4000</b>					
0					0.02
1000					0.06
2000					0.1
3000					0.14
4000					0.18

First apply a four wire short to the 525A 4W RTD Ohm input. Set the 525A to the 400 ohm range. Note the reading. Set the 525A to the 4000 ohm range. Note the reading. Move the 525A 4W RTD Ohm input to the output of the 5520A. Output the same nominal values and note the 525A readings in the 525A reading column. Subtract the actual 5520A value from the 525A reading and ensure that it is within the specified tolerance.

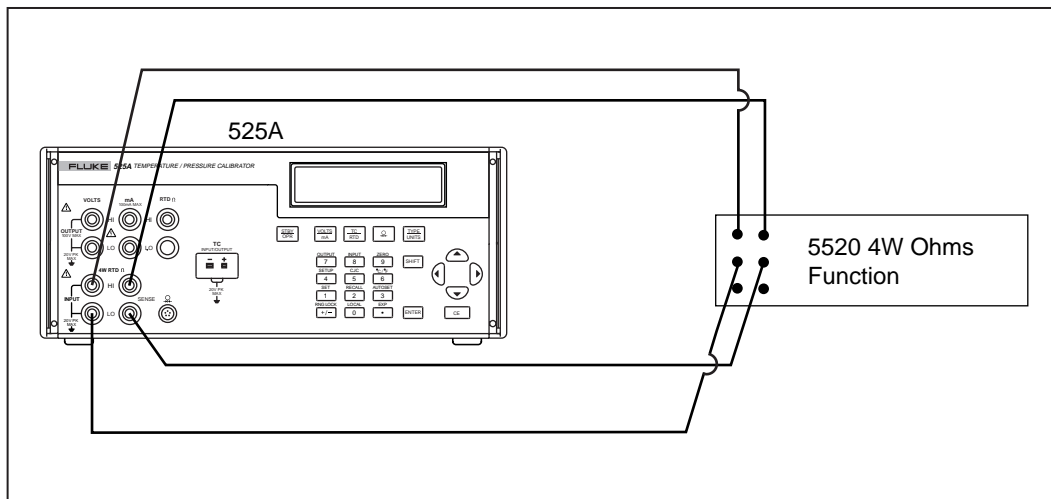

ajr27f.eps

**Figure 6-8. Connection for Measuring Ohms**

### **Testing Pressure Modules**

The Fluke 700 series pressure modules are calibrated separately from the 525A. The calibration follows the pressure module, so only a performance test is needed. Connect any of the Fluke 700 series pressure modules to the pressure module connector. Verify that the 525A reads pressure.

## ***Service Center Calibration or Repair***

Calibration, repairs, or servicing not covered in this manual should be performed only by qualified service personnel.

Verify that the Calibrator is being operated in accordance with the instructions in this manual. If the Calibrator is faulty, send a description of the failure with the Calibrator. Pressure modules do not need to accompany the Calibrator unless the module is faulty also. Be sure to pack the Calibrator securely, using the original shipping container if it is available. Send the equipment postage paid and insured, to the nearest Service Center. Fluke assumes no responsibility for damage in transit.

The Fluke 525A Calibrator covered by the warranty will be promptly repaired or replaced (at Fluke's option) and returned to you at no charge. For more information about warranty terms, refer to the Warranty provided earlier in this manual. If the warranty period has expired, the Calibrator will be repaired and returned for a fixed fee. If the Calibrator or pressure module is not covered under the warranty terms, contact an authorized Service Center for a price quote for repair.

To locate an authorized Service Center, refer to "Contacting Fluke" at the beginning of the manual.

## Replacement Parts

Replacement parts are shown in Figure 6-9. Table 6-9 provides a description and part number of each replacement part.

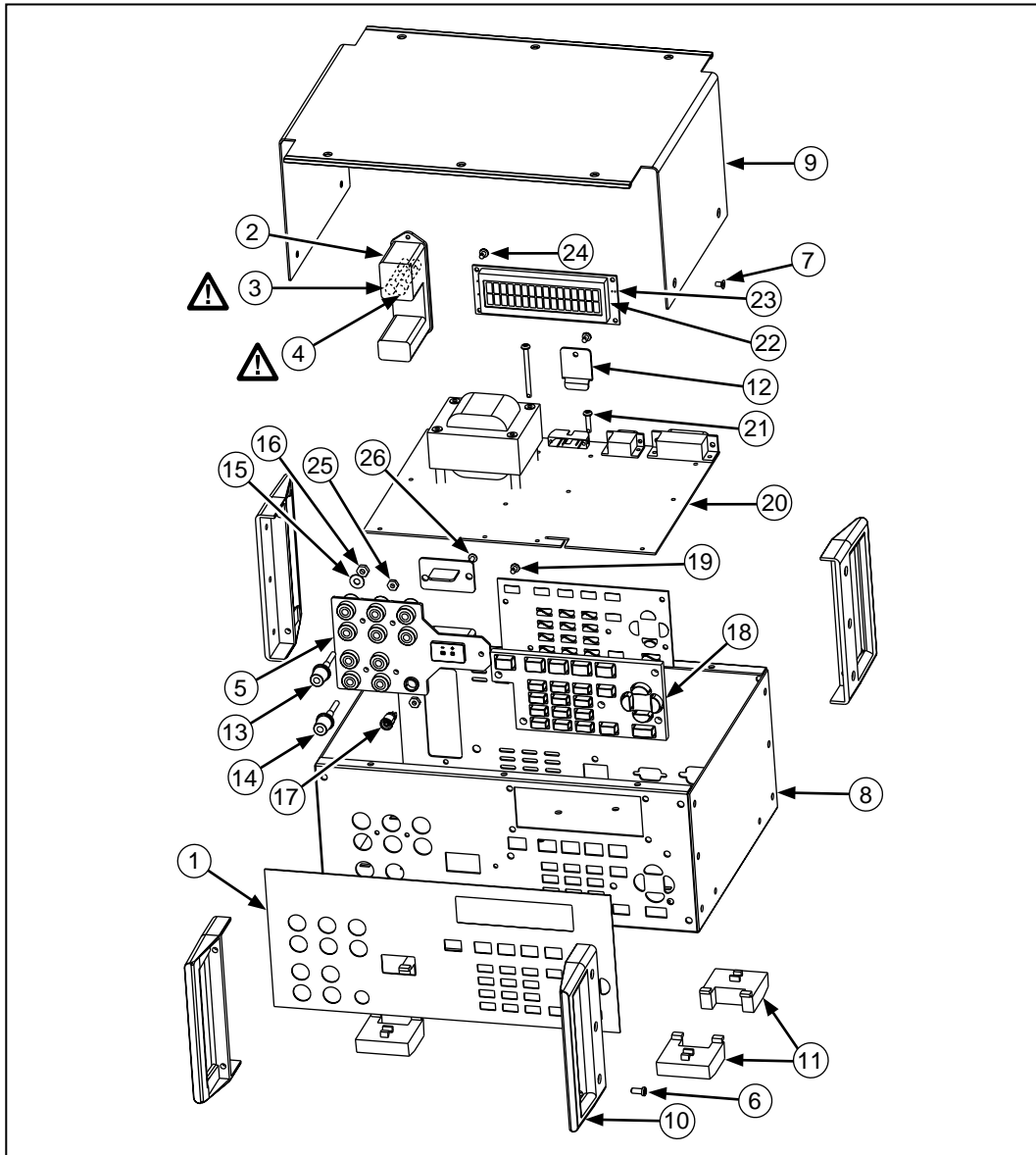

ajr20f.eps

Figure 6-9. Exploded View of the 525A

**Table 6-7. Replacement Parts**

Item	Description	Part Number
1	Decal, Front Panel	1601576
2	Fuse Drawer	1617918
3	⚠ Fuse, 0.25 A/250 V (fast for 120 V operation)	1645311
4	⚠ Fuse, 0.125 A/250 V (fast for 240 V operation)	1645327
5	Output Block	1601601
6	Allen Head Screw	295105
7	Flat Head Screw	320093
8	Assembly, Chassis	1601583
9	Cover, Instrument Top	1601590
10	Handle	886341
11	Bottom Foot, Molded	868786
12	Programming Connector Door	1607078
13	Red Binding Post	886382
14	Black Binding Post	886379
15	Low Thermal Washer #8	859939
16	Low Thermal Nut 8-32	850334
17	Lemo Connector	942714
18	Keypad	1601565
19	6-32 x .25 screws for keypad	152140
20	Main PCB assembly	1618591
21	6-32 x .5 screws for main PCB	320051
22	LCD	1617941
23	Display PCB	1618617
24	6-32 x .375 nylon screws for display PCB	260646
25	6-32 output block retaining nut	110551
26	5-20 x .312 screw for TC board	494641
⚠ For safety, use exact replacement only.		

## Accessories

For more information about these accessories and their prices, contact your Fluke representative.

### Y525 Rack Mount Kit

The Y525 rack mount kit provides all the hardware needed to mount the 525A on an equipment rack. Instructions are provided in the kit.

### 5520A – 525A Test Lead Kit

The optional test lead kit, 5520A – 525A test lead kit, contains thermocouple extension wires, thermocouple adapter, binding post adapters, and test leads.

### Pressure Modules

Pressure modules are listed below.

**Table 6-8. Fluke 700 Series Pressure Modules**

Fluke Model Number	Range	Type and Media
Fluke-700P00	0 to 1 inH <sub>2</sub> O	differential, dry
Fluke-700P01	0 to 10 inH <sub>2</sub> O	differential, dry
Fluke-700P02	0 to 1 psi	differential, dry
Fluke-700P22	0 to 1 psi	differential, wet
Fluke-700P03	0 to 5 psi	differential, dry
Fluke-700P23	0 to 5 psi	differential, wet
Fluke-700P04	0 to 15 psi	differential, dry
Fluke-700P24	0 to 15 psi	differential, wet
Fluke-700P05	0 to 30 psi	gage, wet
Fluke-700P06	0 to 100 psi	gage, wet
Fluke-700P07	0 to 500 psi	gage, wet
Fluke-700P08	0 to 1,000 psi	gage, wet
Fluke-700P09	0 to 1,500 psi	gage, wet
Fluke-700P27	0 to 300 psi	gage, wet
Fluke-700P29	0 to 3,000 psi	gage, wet
Fluke-700P30	0 to 5,000 psi	gage, wet
Fluke-700P31	0 to 10,000 psi	gage, wet
Fluke-700PA3	0 to 5 psi	absolute, wet



**Table 6-8 Fluke 700 Series Pressure Modules (continued)**

<b>Fluke Model Number</b>	<b>Range</b>	<b>Type and Media</b>
Fluke-700PA4	0 to 15 psi	absolute, wet
Fluke-700PA5	0 to 30 psi	absolute, wet
Fluke-700PA6	0 to 100 psi	absolute, wet
Fluke-700PV3	0 to – 5 psi	vacuum, dry
Fluke-700PV4	0 to – 15 psi	vacuum, dry
Fluke-700PD2	±1 psi	dual range, dry
Fluke-700PD3	±5 psi	dual range, dry
Fluke-700PD4	±15 psi	dual range, dry
Fluke-700PD5	-15/+30 psi	dual range, wet
Fluke-700PD6	-15/+100 psi	dual range, wet
Fluke-700PD7	-15/+200 psi	dual range, wet

**Table 6-9. Fluke 6100 Series Pressure Modules**

<b>Fluke Model Number</b>	<b>Range</b>	<b>Type and Media</b>
Fluke-6100P04	0 to 15 psi	differential, dry
Fluke-6100P05	0 to 30 psi	gage, wet
Fluke-6100P06	0 to 100 psi	gage, wet
Fluke-6100P07	0 to 500 psi	gage, wet
Fluke-6100P08	0 to 1000 psi	gage, wet
Fluke-6100P29	0 to 3000 psi	gage, wet
Fluke-6100PA4	0 to 15 psi	absolute, wet
Fluke-6100PV4	–15 to 0 psi	vacuum, dry



# Chapter 7

## Specifications

### General Specifications

Warm up time	Twice the time since last warmed up, to a maximum of 30 minutes.
Settling time	Less than 5 seconds for all functions and ranges except as noted.
Standard interface	RS-232
Optional interface	IEEE-488 (GPIB)
Temperature performance	Operating            0 °C to 50 °C Calibration (tcal)    18 °C to 28 °C Storage                -20 °C to 70 °C
Electromagnetic compatibility	CE: Conforms to EN61326
Temperature coefficient	Temperature coefficient for temperatures outside tcal $\pm 5$ °C is 10 % of the 90 day specification (or 1 year if applicable) per °C
Relative humidity	Operating    <80 % to 30 °C, <70% to 40 °C, <40 % to 50 °C Storage       <95 % noncondensing
Altitude	Operating        3,050 m (10,000 ft) maximum Nonoperating    12,200 m (40,000 ft) maximum
Safety	EN 61010 Second, ANSI/ISA-S82.01-1994, CAN/CSA-C22.2 No. 1010.1-92, NRTL
Analog low isolation	20 V
Line power	Line Voltage (selectable)    100 V/120 V or 220 V/240 V Line Frequency                47 to 63 Hz Line Voltage Variation $\pm 10$ % about line voltage setting
Power consumption	15 VA maximum
Dimensions	Height 13.3 cm (5.25 in) plus 1.5 cm (0.6 in) four feet on bottom Width $\frac{3}{4}$ standard rack width Depth 47.3 cm (18.6 in) overall
Weight (without options)	4 kg (9 lb)

## DC Voltage Specifications, Output

Ranges <sup>1</sup>	Absolute Uncertainty, tcal $\pm 5^{\circ}\text{C}$ $\pm$ (ppm of output + $\mu\text{V}$ )				Stability		Resolution	Maximum Burden <sup>2</sup>
	90 days		1 year		24 hours, $\pm 1^{\circ}\text{C}$ $\pm$ (ppm of output + $\mu\text{V}$ )			
0 to 100.000 mV	25	3	30	3	5 +2		1 $\mu\text{V}$	10 mA
0 to 1.00000 V	25	20	30	20	4 +20		10 $\mu\text{V}$	10 mA
0 to 10.0000 V	25	200	30	200	4 +200		100 $\mu\text{V}$	10 mA
0 to 100.000 V	25	2 mV	30	2 mV	5 +1 mV		1 mV	1 mA
<b>TC Output</b>								
-10 to 75.000 mV	25	3 $\mu\text{V}$	30	3 $\mu\text{V}$	5 +2 $\mu\text{V}$		1 $\mu\text{V}$	10 $\Omega$
1. All outputs are positive only. 2. Remote sensing is not provided. Output resistance is $< 1\Omega$ .								

Ranges	Noise	
	Bandwidth 0.1 to 10 Hz (ppm of output + $\mu\text{V}$ p-p)	Bandwidth 10 Hz to 10 kHz ( $\mu\text{V}$ rms)
0 to 100.000 mV	1 $\mu\text{V}$	6 $\mu\text{V}$
0 to 1.00000 V	10 $\mu\text{V}$	60 $\mu\text{V}$
0 to 10.0000 V	100 $\mu\text{V}$	600 $\mu\text{V}$
0 to 100.000 V	10 ppm+1 mV	20 mV

## DC Current Specifications, Output

Ranges <sup>1</sup>	Absolute Uncertainty, tcal $\pm 5^{\circ}\text{C} \pm$ (ppm of output + $\mu\text{A}$ )				Resolution	Maximum Compliance Voltage	Maximum Inductive Load
	90 days		1 year				
0 to 100.000 mA	85	2	100	2	1 $\mu\text{A}$	10 V	100 $\mu\text{H}$
1. All outputs are positive only.							

Ranges	Noise	
	Bandwidth 0.1 to 10 Hz p-p	Bandwidth 10 Hz to 10 kHz rms
0 to 100.000 mA	2000 nA	20 $\mu\text{A}$

## Resistance Specifications, Output

Ranges <sup>1</sup>	Absolute Uncertainty, tcal $\pm 5^{\circ}\text{C}, \pm \Omega$ )		Resolution	Allowable Current <sup>1</sup>
	90 days	1 year		
5 to 400.00 $\Omega$	0.025	0.03	0.01 $\Omega$	1 to 10 mA
5 to 4.0000 k $\Omega$	0.25	0.3	0.1 $\Omega$	250 $\mu\text{A}$ to 1 mA
1. Continuously variable from 0 to 4 k $\Omega$ . 2. For currents lower than shown, the floor adder increases by $\text{Floor}(\text{new}) = \text{Floor}(\text{old}) \times I_{\text{min}}/I_{\text{actual}}$ . For example, a 500 $\mu\text{A}$ stimulus measuring 100 $\Omega$ has a floor uncertainty of $0.025\Omega \times 1 \text{ mA}/500 \mu\text{A} = 0.05 \Omega$ .				

## Resistance Specifications, Input

Ranges	Absolute Uncertainty, tcal $\pm 5^{\circ}\text{C}, \pm$ (ppm of output + $\Omega$ )				Resolution	Stimulus Current
	90 days		1 year			
0 to 400.00 $\Omega$	35	0.003	40	0.003	0.001 $\Omega$	1 mA
401 to 4001.00 $\Omega$	35	0.03	40	0.03	0.01 $\Omega$	0.1 mA

## Thermocouple Specification, Output and Input

TC Type	Range (° C)		Absolute Uncertainty, tcal ±5 °C, ±(°C) <sup>1</sup>	
			Output/Input	
	Minimum	Maximum	90 days	1 year
B	600 °C	800 °C	0.42 °C	0.46 °C
	800 °C	1000 °C	0.39 °C	0.39 °C
	1000 °C	1550 °C	0.40 °C	0.40 °C
	1550 °C	1820 °C	0.44 °C	0.45 °C
C	0 °C	150 °C	0.25 °C	0.30 °C
	150 °C	650 °C	0.21 °C	0.26 °C
	650 °C	1000 °C	0.23 °C	0.31 °C
	1000 °C	1800 °C	0.38 °C	0.50 °C
	1800 °C	2316 °C	0.63 °C	0.84 °C
E	-250 °C	-100 °C	0.38 °C	0.50 °C
	-100 °C	-25 °C	0.16 °C	0.18 °C
	-25 °C	350 °C	0.14 °C	0.15 °C
	350 °C	650 °C	0.14 °C	0.16 °C
	650 °C	1000 °C	0.16 °C	0.21 °C
J	-210 °C	-100 °C	0.20 °C	0.27 °C
	-100 °C	-30 °C	0.18 °C	0.20 °C
	-30 °C	150 °C	0.14 °C	0.16 °C
	150 °C	760 °C	0.14 °C	0.17 °C
	760 °C	1200 °C	0.18 °C	0.23 °C
K	-200 °C	-100 °C	0.25 °C	0.33 °C
	-100 °C	-25 °C	0.19 °C	0.22 °C
	-25 °C	120 °C	0.14 °C	0.16 °C
	120 °C	1000 °C	0.19 °C	0.26 °C
	1000 °C	1372 °C	0.30 °C	0.40 °C
L	-200 °C	-100 °C	0.37 °C	0.37 °C
	-100 °C	800 °C	0.26 °C	0.26 °C
	800 °C	900 °C	0.17 °C	0.17 °C
N	-200 °C	-100 °C	0.33 °C	0.40 °C
	-100 °C	-25 °C	0.20 °C	0.24 °C
	-25 °C	120 °C	0.16 °C	0.19 °C
	120 °C	410 °C	0.14 °C	0.18 °C
	410 °C	1300 °C	0.21 °C	0.27 °C

1. Does not include thermocouple wire error.

**Thermocouple Specification, Output and Input (continued)**

TC Type	Range (° C)		Absolute Uncertainty, tcal ±5 °C, ±(°C) <sup>1</sup>	
			Output/Input	
	Minimum	Maximum	90 days	1 year
R	0 °C 250 °C 400 °C 1000 °C	250 °C 400 °C 1000 °C 1750 °C	0.58 °C 0.34 °C 0.31 °C 0.30 °C	0.58 °C 0.35 °C 0.33 °C 0.40 °C
S	0 °C 250 °C 1000 °C 1400 °C	250 °C 1000 °C 1400 °C 1750 °C	0.56 °C 0.36 °C 0.30 °C 0.35 °C	0.56 °C 0.36 °C 0.37 °C 0.46 °C
T	-250 °C -150 °C 0 °C 120 °C	-150 °C 0 °C 120 °C 400 °C	0.51 °C 0.18 °C 0.13 °C 0.12 °C	0.63 °C 0.24 °C 0.16 °C 0.14 °C
U	-200 °C 0 °C	0 °C 600 °C	0.56 °C 0.27 °C	0.56 °C 0.27 °C
mV	-10 to 75.000 mV			
1. Does not include thermocouple wire error.				

## RTD and Thermistor Specification, Output

RTD Type	Range (° C)		Absolute Uncertainty tcal $\pm 5$ °C, $\pm$ (°C) <sup>1</sup>	
	Minimum	Maximum	90 days	1 year
Pt 385, 100 $\Omega$	-200 °C	-80 °C	0.06 °C	0.07 °C
	-80 °C	0 °C	0.08 °C	0.10 °C
	0 °C	100 °C	0.08 °C	0.10 °C
	100 °C	300 °C	0.07 °C	0.09 °C
	300 °C	400 °C	0.07 °C	0.09 °C
	400 °C	630 °C	0.08 °C	0.09 °C
	630 °C	800 °C	0.08 °C	0.10 °C
Pt 3926, 100 $\Omega$	-200 °C	-80 °C	0.06 °C	0.07 °C
	-80 °C	0 °C	0.06 °C	0.07 °C
	0 °C	100 °C	0.06 °C	0.08 °C
	100 °C	300 °C	0.07 °C	0.08 °C
	300 °C	400 °C	0.07 °C	0.09 °C
Pt 3916, 100 $\Omega$	-200 °C	-190 °C	0.06 °C	0.07 °C
	-190 °C	-80 °C	0.06 °C	0.08 °C
	-80 °C	0 °C	0.06 °C	0.08 °C
	0 °C	100 °C	0.06 °C	0.08 °C
	100 °C	260 °C	0.07 °C	0.08 °C
	260 °C	300 °C	0.07 °C	0.08 °C
	300 °C	400 °C	0.07 °C	0.09 °C
400 °C	600 °C	0.08 °C	0.09 °C	
Pt 385, 200 $\Omega$	-200 °C	-80 °C	0.31 °C	0.38 °C
	-80 °C	0 °C	0.32 °C	0.38 °C
	0 °C	100 °C	0.33 °C	0.39 °C
	100 °C	260 °C	0.33 °C	0.39 °C
	260 °C	300 °C	0.36 °C	0.43 °C
	300 °C	400 °C	0.36 °C	0.43 °C
	400 °C	600 °C	0.42 °C	0.50 °C
600 °C	630 °C	0.42 °C	0.50 °C	
Pt 385, 500 $\Omega$	-200 °C	-80 °C	0.13 °C	0.15 °C
	-80 °C	0 °C	0.13 °C	0.15 °C
	0 °C	100 °C	0.13 °C	0.16 °C
	100 °C	260 °C	0.14 °C	0.17 °C
	260 °C	300 °C	0.14 °C	0.17 °C
	300 °C	400 °C	0.15 °C	0.18 °C
	400 °C	600 °C	0.16 °C	0.19 °C
600 °C	630 °C	0.16 °C	0.19 °C	
1. 2-wire output				



**RTD and Thermistor Specification, Output (continued)**

RTD Type	Range (° C)		Absolute Uncertainty tcal ±5 °C, ±(°C) <sup>1</sup>	
	Minimum	Maximum	90 days	1 year
Pt 385, 1000 Ω	-200 °C	-80 °C	0.06 °C	0.07 °C
	-80 °C	0 °C	0.06 °C	0.08 °C
	0 °C	100 °C	0.07 °C	0.08 °C
	100 °C	260 °C	0.07 °C	0.08 °C
	260 °C	300 °C	0.07 °C	0.09 °C
	300 °C	400 °C	0.07 °C	0.09 °C
	400 °C	600 °C	0.08 °C	0.09 °C
	600 °C	630 °C	0.08 °C	0.09 °C
PtNi 385, 120 Ω (Ni 120)	-80 °C	0 °C	0.04 °C	0.05 °C
	0 °C	100 °C	0.04 °C	0.04 °C
	100 °C	260 °C	0.03 °C	0.03 °C
Cu 427, 10 Ω <sup>2</sup>	-100 °C	260 °C	0.63 °C	0.75 °C
YSI 400	15 °C	50 °C	0.005 °C	0.007 °C
1. 2-wire output 2. Based on MINCO Application Aid No. 18.				

## RTD and Thermistor Specification, Input

RTD Type	Range (° C)		Absolute Uncertainty, tcal $\pm 5$ °C, $\pm$ (°C) <sup>1</sup>	
	Minimum	Maximum	90 days	1 year
Pt 385, 100 $\Omega$	-200 °C	-80 °C	0.031 °C	0.012 °C
	-80 °C	0 °C	0.018 °C	0.020 °C
	0 °C	100 °C	0.018 °C	0.020 °C
	100 °C	300 °C	0.027 °C	0.030 °C
	300 °C	400 °C	0.031 °C	0.035 °C
	400 °C	630 °C	0.042 °C	0.047 °C
	630 °C	800 °C	0.050 °C	0.057 °C
Pt 3926, 100 $\Omega$	-200 °C	-80 °C	0.031 °C	0.031 °C
	-80 °C	0 °C	0.014 °C	0.015 °C
	0 °C	100 °C	0.018 °C	0.019 °C
	100 °C	300 °C	0.026 °C	0.029 °C
	300 °C	400 °C	0.031 °C	0.034 °C
Pt 3916, 100 $\Omega$	-200 °C	-190 °C	0.026 °C	0.028 °C
	-190 °C	-80 °C	0.011 °C	0.012 °C
	-80 °C	0 °C	0.014 °C	0.015 °C
	0 °C	100 °C	0.018 °C	0.019 °C
	100 °C	260 °C	0.025 °C	0.028 °C
	260 °C	300 °C	0.026 °C	0.029 °C
	300 °C	400 °C	0.031 °C	0.034 °C
Pt 385, 200 $\Omega$	-200 °C	-80 °C	0.071 °C	0.072 °C
	-80 °C	0 °C	0.075 °C	0.076 °C
	0 °C	100 °C	0.079 °C	0.081 °C
	100 °C	260 °C	0.082 °C	0.085 °C
	260 °C	300 °C	0.090 °C	0.093 °C
	300 °C	400 °C	0.093 °C	0.097 °C
	400 °C	600 °C	0.100 °C	0.105 °C
600 °C	630 °C	0.101 °C	0.106 °C	

1. 4-wire mode. Uncertainties listed do not include probe uncertainties.

**RTD and Thermistor Specification, Input (continued)**

RTD Type	Range (° C)		Absolute Uncertainty, tcal ±5 °C, ±(°C) <sup>1</sup>	
	Minimum	Maximum	90 days	1 year
Pt 385, 500 Ω	-200 °C	-80 °C	0.046 °C	0.047 °C
	-80 °C	0 °C	0.049 °C	0.050 °C
	0 °C	100 °C	0.043 °C	0.045 °C
	100 °C	260 °C	0.030 °C	0.033 °C
	260 °C	300 °C	0.032 °C	0.035 °C
	300 °C	400 °C	0.037 °C	0.041 °C
	400 °C	600 °C	0.047 °C	0.052 °C
	600 °C	630 °C	0.048 °C	0.076 °C
Pt 385, 1000 Ω	-200 °C	-80 °C	0.031 °C	0.032 °C
	-80 °C	0 °C	0.034 °C	0.035 °C
	0 °C	100 °C	0.039 °C	0.040 °C
	100 °C	260 °C	0.025 °C	0.028 °C
	260 °C	300 °C	0.027 °C	0.030 °C
	300 °C	400 °C	0.030 °C	0.034 °C
	400 °C	600 °C	0.041 °C	0.045 °C
	600 °C	630 °C	0.042 °C	0.047 °C
PtNi 385, 120 Ω (Ni120)	-80 °C	0 °C	0.209 °C	0.210 °C
	0 °C	100 °C	0.210 °C	0.211 °C
	100 °C	260 °C	0.211 °C	0.212 °C
Cu 427, 10 Ω <sup>2</sup>	-100 °C	260 °C	0.300 °C	0.069 °C
YSI 400	15 °C	50 °C	0.005 °C	0.304 °C
SPRT, 25 Ω	User Defined	User Defined	0.05 °C	0.06 °C
<p>1. 4-wire mode. Uncertainties listed do not include probe uncertainties.</p> <p>2. Based on MINCO Application Aid No. 18.</p>				

## Pressure Measurement

The Calibrator can accept either the Fluke 700 or 6100 series pressure modules. Pressure modules plug directly into the front panel Lemo connector with the Calibrator firmware autodetecting the type and value of the module you are attaching.

Range	Accuracy/Resolution	Units
Determined by pressure module	Determined by pressure module	PSI (pounds per square inch)  inH2O4°C (inches of water at 4 degrees Celsius)  inH2O20C (inches of water at 20 degrees Celsius)  cmH2O4°C (centimeters of water at 4 degrees Celsius)  cmH2O20C (centimeters of water at 20 degrees Celsius)  BAR (bars)  mBAR (millibars)  KPAL (kilopascals)  inHG 0°C (inches of mercury at 0 degrees Celsius)  mmHG 0°C (millimeters of mercury at 0 degrees Celsius)  Kg/cm2 (kilograms per square centimeter)