

Aug.1.2018 Copyright 2018 HIROSE ELECTRIC CO., LTD. All Rights Reserved.
 In case that the application demands a high level of reliability, such as automotive,
 please contact a company representative for further information.

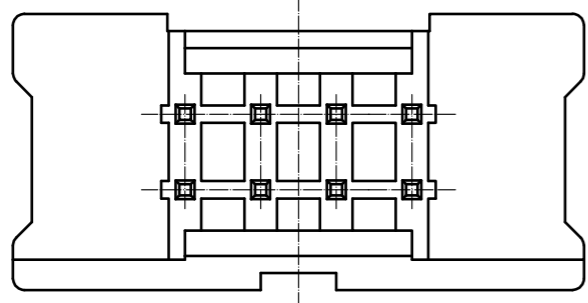
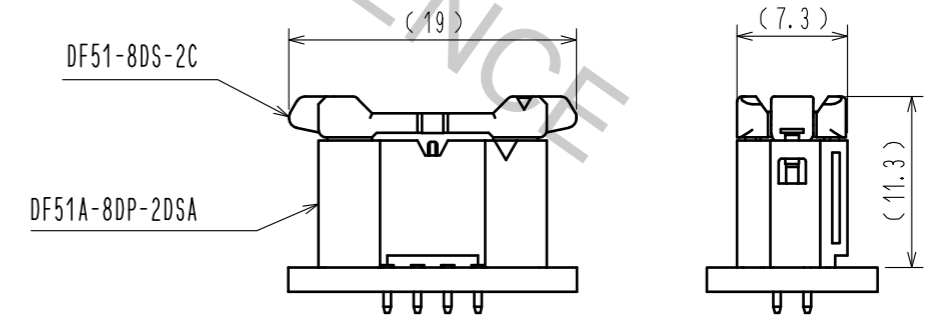
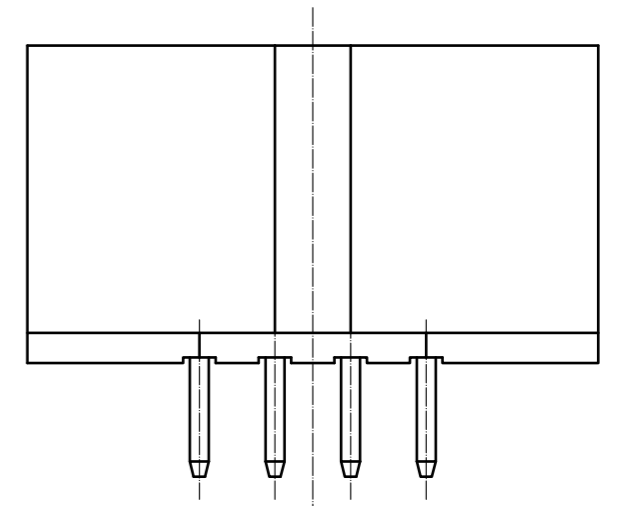
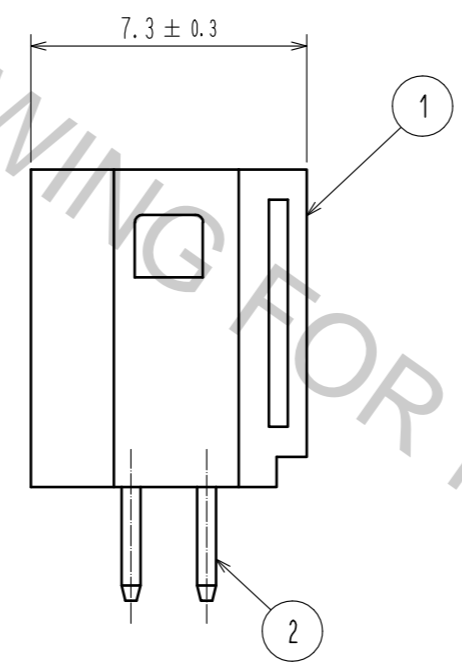
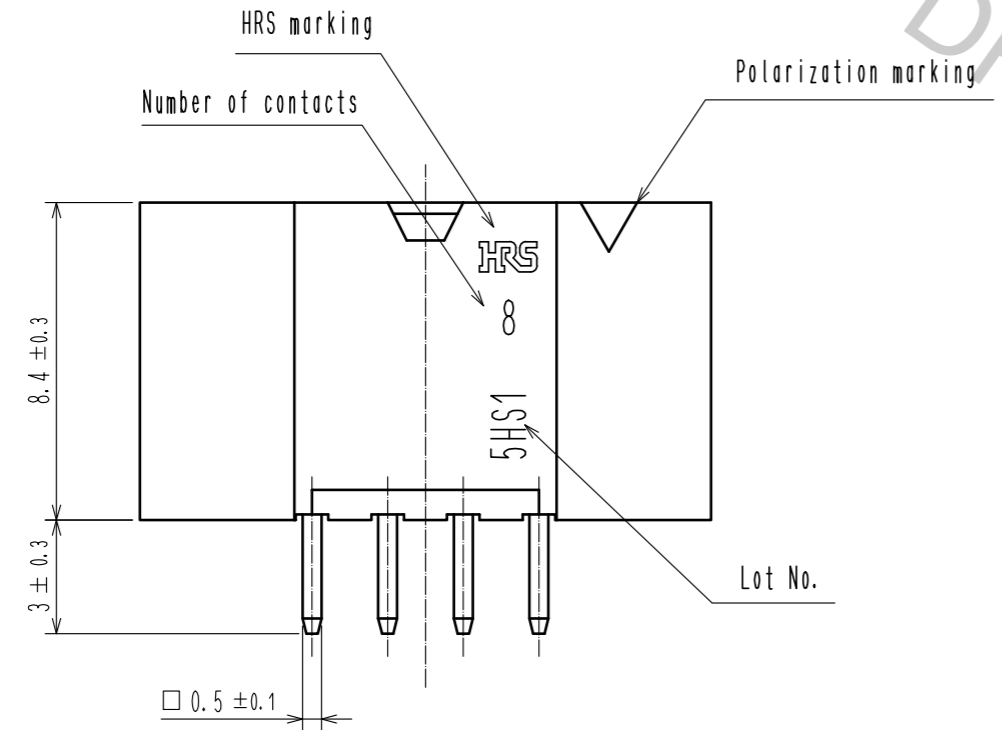
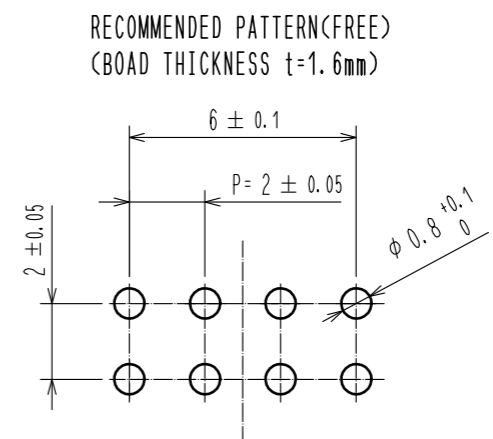
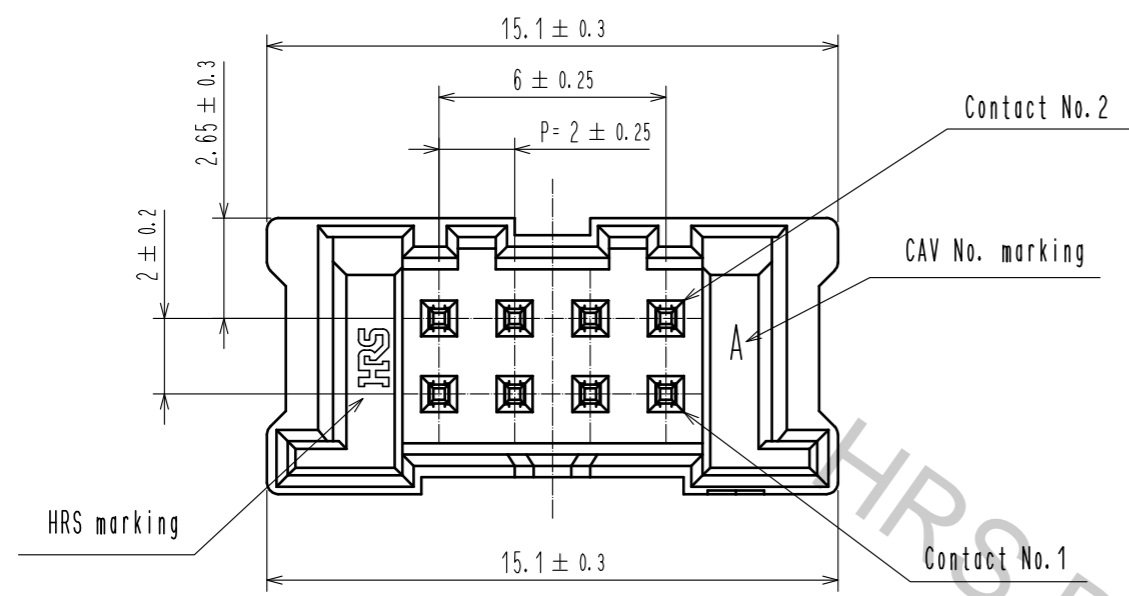

Note 1. Per pack : 100 Pieces.
 2. The dimension parenthesis are for reference.

1	PBT	UL94V-0, BLACK	2	BRASS	SURFACE:Sn PLATING 1 μ m MIN UNDER PLATING:NICKEL PLATING 0.5 μ m MIN		
NO.	MATERIAL	FINISH, REMARKS	NO.	MATERIAL	FINISH, REMARKS		
UNITS mm		SCALE 5 : 1	COUNT 	DESCRIPTION OF REVISIONS	DESIGNED	CHECKED	DATE
HRS HIROSE ELECTRIC CO., LTD.		APPROVED : HS. OKAWA	17.10.04	DRAWING NO. EDC-363505-00-00			
		CHECKED : ST. WADA	17.10.04	PART NO. DF51A-8DP-2DSA			
		DESIGNED : TH. SATO	17.10.04	CODE NO. CL543-5045-0-00			
		DRAWN : TH. SATO	17.10.04				