

Assembly Instructions for - 37368

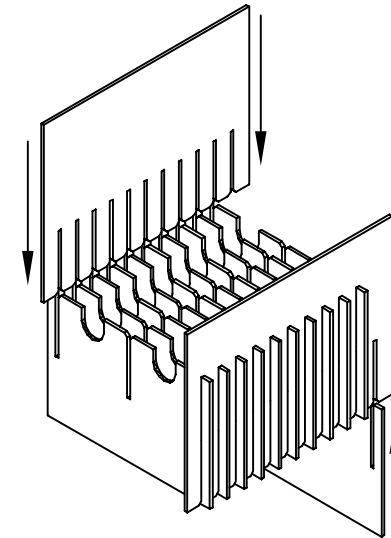
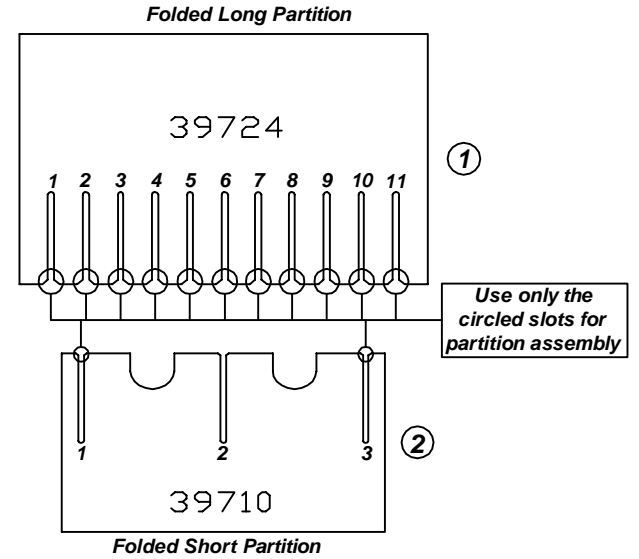
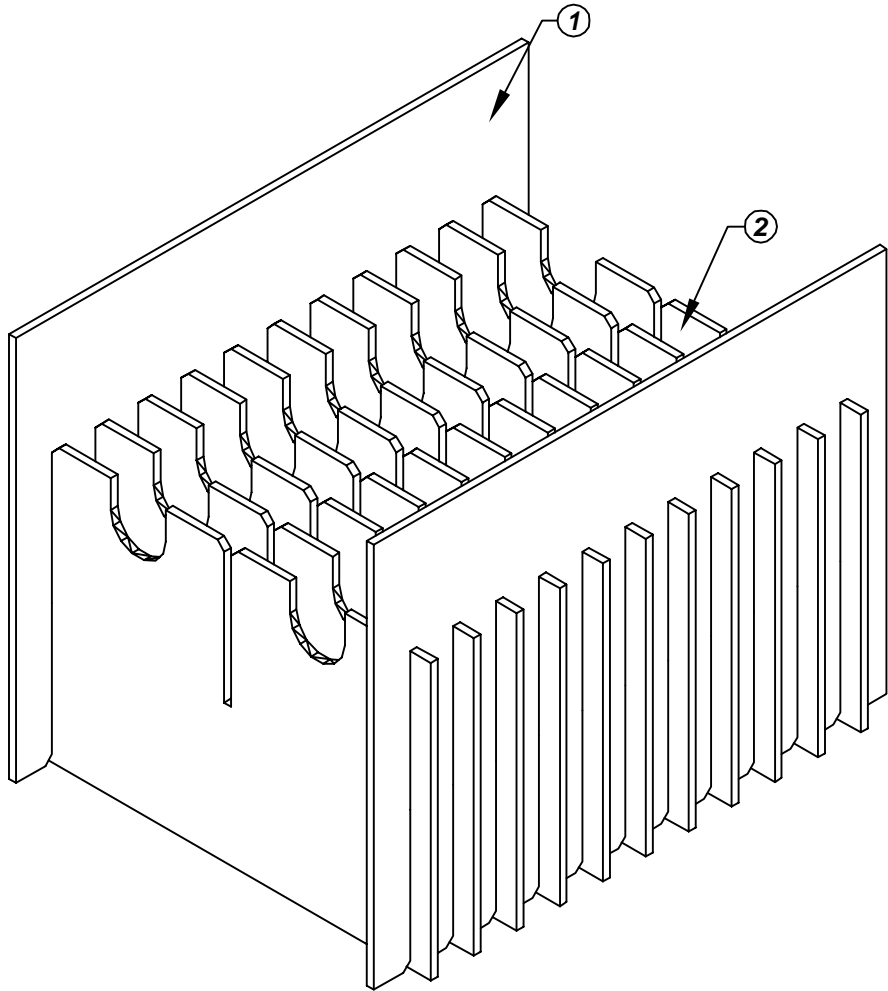

Made in America

F/N	Part #	Dimensions:	Description:	Qty:
①	39724	28-1/4" x 18-5/8"	464-HLP-12 Long Partition	2
②	39710	20-1/4" x 14-3/4"	460/462/464-HSP Short Partition	11

37368 - 12 Cell Inplant Handler Cell Size - 14" x 12-3/4" x 1-1/4"

Notes:
For use with the following storage container & lid:
37526 - Storage Container
37554 - Lid

PROTEKTIVE PAK
13520 MONTE VISTA AVENUE, CHINO, CA 91710
PHONE (909) 627-2578, FAX (909) 363-7331
ProtektivePak.com

PROTEKTIVE PAK
BURIED CONDUCTIVE LAYER

DRAWING NUMBER
IPH-37368

DATE
Nov.
2007