

Telegesis™	 <b>SILICON LABS</b>	TG-RF-PM-501 ZigBee RangeFinder
ZigBee RangeFinder		Product Manual 0501 r8

Telegesis™ is a trademark of Silicon Laboratories Inc.

# Telegesis ZigBee RangeFinder

---

## Product Manual



Rev: 8

Date: Sept 2014

Guide for firmware versions: R311 and R211

Patent pending: GB1222898.7

## Table of Contents

Table of Contents.....	2
Table of Figures.....	4
Package Contents.....	5
Specifications.....	6
Handheld Terminal (HHT) .....	6
Satellite (SAT-x) .....	6
Handheld Terminal Unit .....	7
Layout .....	7
Functionality .....	9
Start-up:.....	10
Menu Screens:.....	11
Normal Test Modes:.....	12
Continuous Test Modes: .....	16
Device Configurations: .....	23
Firmware Upgrades: .....	27
Data Logging: .....	30
Device Info.....	33
Adjust Contrast .....	33
PAN Scan .....	34
Power .....	36
Batteries .....	36
Charging .....	36
Power Saving.....	36
Satellite Unit.....	37
Layout .....	37
Functionality .....	38
Buttons .....	38
LEDs.....	39
Power .....	39
Batteries .....	39
Power Consumption.....	39
Usage .....	39
System Topology.....	39
Workflow .....	41

---

Interpreting Test Results .....	42
RSSI Calculation.....	42
Packet Error Rate .....	42
Pass/Fail Criteria .....	42

## Table of Figures

Figure 1: Package Contents.....	5
Figure 2: Handheld Terminal Front .....	7
Figure 3: Handheld Terminal Back .....	8
Figure 4: Product Label.....	9
Figure 5: Start-up Screen.....	10
Figure 6: Start-up Screen.....	11
Figure 7: Pre-Test Screen.....	12
Figure 8: Test Start Screen .....	13
Figure 9: Screen for Test A and B.....	14
Figure 10: Energy Scan Screen .....	15
Figure 11: Tx tone.....	16
Figure 12: Continuous Ping Configuration.....	17
Figure 13: Continuous Ping Results .....	18
Figure 14: Single Channel E-Scan .....	19
Figure 15 One hop configuration screen .....	20
Figure 16 One Hop Test Result Screens.....	21
Figure 17: Configurations Screen.....	24
Figure 18: Advanced Configurations Screen .....	25
Figure 19: Configurations Parameter Limits .....	26
Figure 20 Firmware Upgrade Screens .....	27
Figure 21 HHT Firmware Upgrade .....	27
Figure 22 HHT Firmware upgrade options .....	28
Figure 23 SAT Firmware Options.....	29
Figure 24 Data Logger Screen.....	30
Figure 25: Device Information Screen.....	33
Figure 26: Adjust Contrast Screen .....	33
Figure 27: Battery Symbol.....	36
Figure 28: Battery Charging Symbol .....	36
Figure 29: Satellite Front.....	37
Figure 30: Satellite Back .....	37
Figure 31: Satellite Product Label .....	38
Figure 32: Satellite LED States .....	39
Figure 33: A typical floor plan with Smart Energy equipment locations.....	40
Figure 34: RangeFinder locations: Electric meter, Gas meter and Kitchen work surface.....	40
Figure 35: Workflow .....	41

## Package Contents

The package contains the following items,



**Figure 1: Package Contents**

- a) 1x Quick Start Guide
- b) 4x 1.5V AA Alkaline Batteries
- c) 2x Satellite Units SAT100
- d) 1x USB A to USB Micro Cable
- e) 1x Handheld Terminal ZHT100
- f) 2x 1.2V AA 2000mA Rechargeable Batteries
- g) 3x 2.4GHz Half-wave Antennas

## Specifications

### Handheld Terminal (HHT)

Model Number	ZHT100
RF Interface	2.4GHz IEEE802.15.4
RF Output Power	-9dBm to +8dBm (Standard Version) 20,19,18,16,15,13,10,7,1dBm (Long Range Version)
Antenna	Half-wave Dipole Antenna 2dBi Gain
Battery	2x 1.2V 2000mAH NiMH Rechargeable
Charging	5Volts @ 300mA via USB Micro Connector
Operating Temperature	0 to 50C
Humidity	95% TH Non-condensing
IP Rating	IP54 (subject to testing)

### Satellite (SAT-x)

Model Number	SAT100
RF Interface	2.4GHz IEEE802.15.4
RF Output Power	-9dBm to +8dBm (Standard Version) 20,19,18,16,15,13,10,7,1dBm (Long Range Version)
Antenna	Half-wave Dipole Antenna 2dBi Gain
Battery	2x 1.5V AA Alkaline Batteries
Operating Temperature	0 to 50C
Humidity	95% TH Non-condensing
IP Rating	IP54 (subject to testing)

# Handheld Terminal Unit

## Layout

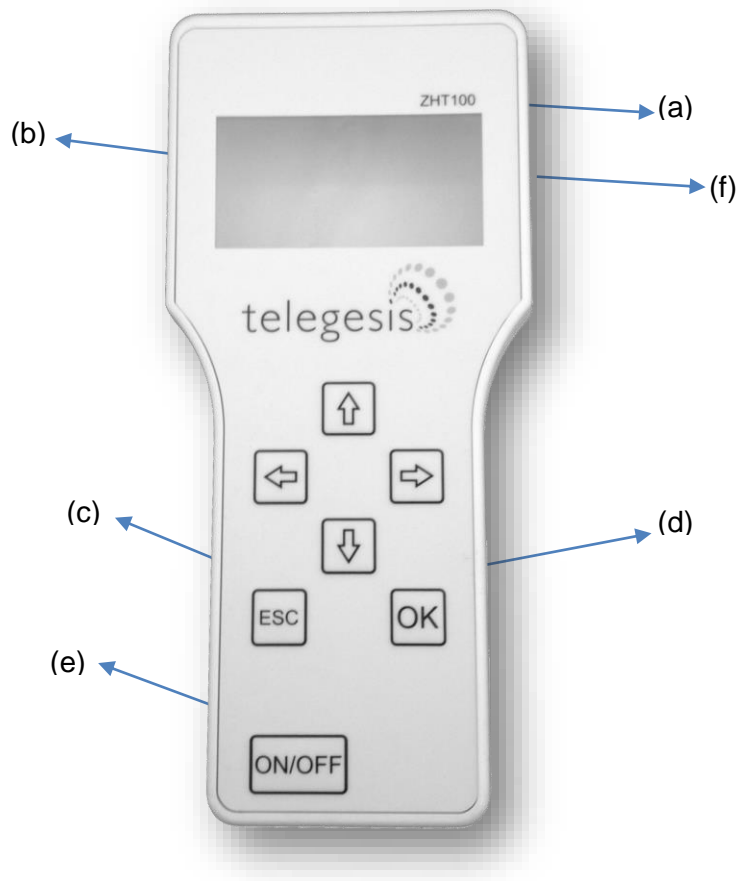
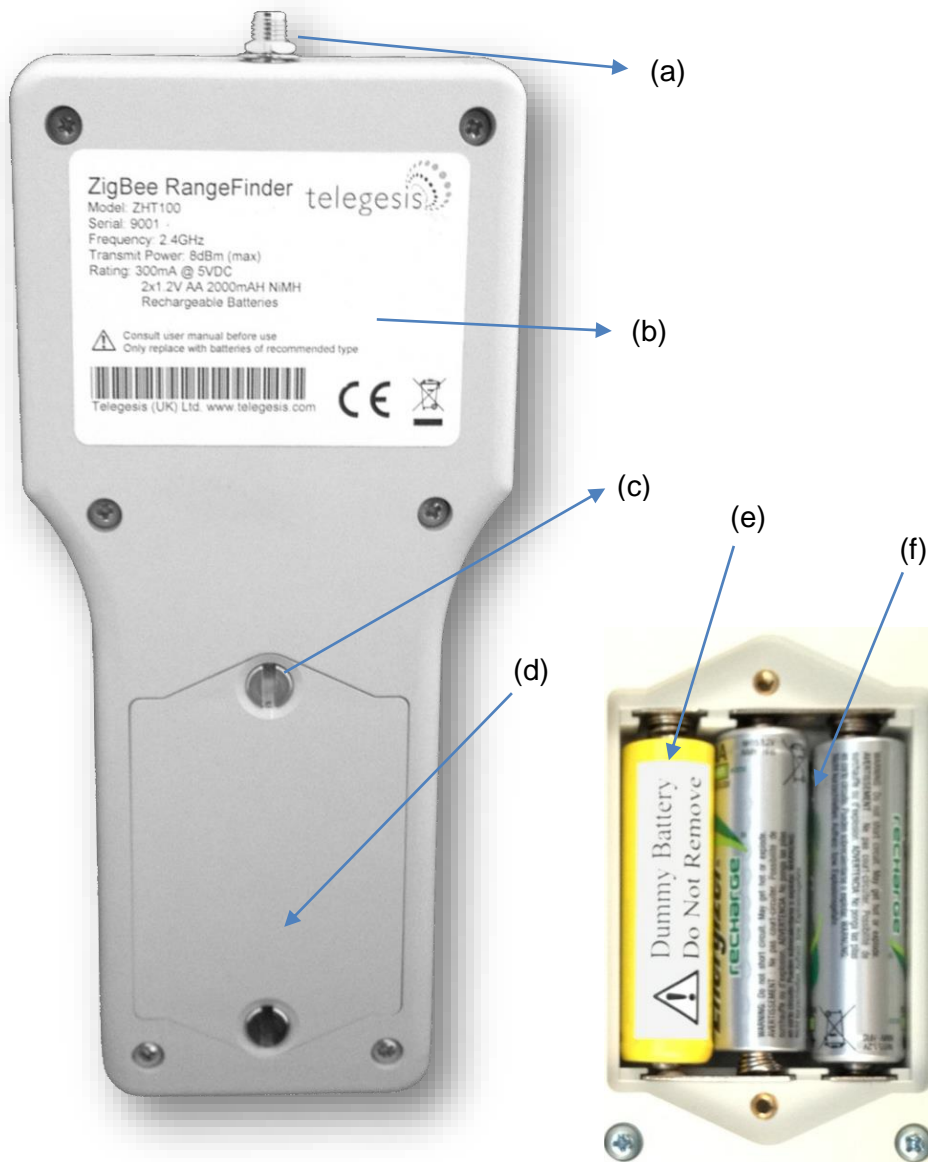

Figure 2: Handheld Terminal Front

### Handheld Terminal Front

- (a) Product Model Number
- (b) LCD Display
- (c) Escape (Back) Key
- (d) Enter (Activate) Key
- (e) Power On/Off Key
- (f) USB-B Micro Connector



**Figure 3: Handheld Terminal Back**

### Handheld Terminal Back

- (a) SMA Connector for Antenna
- (b) Product Label
- (c) 2x Screw for Battery Compartment
- (d) Battery Compartment
- (e) Dummy Battery (non-removable)
- (f) 2x Rechargeable Batteries



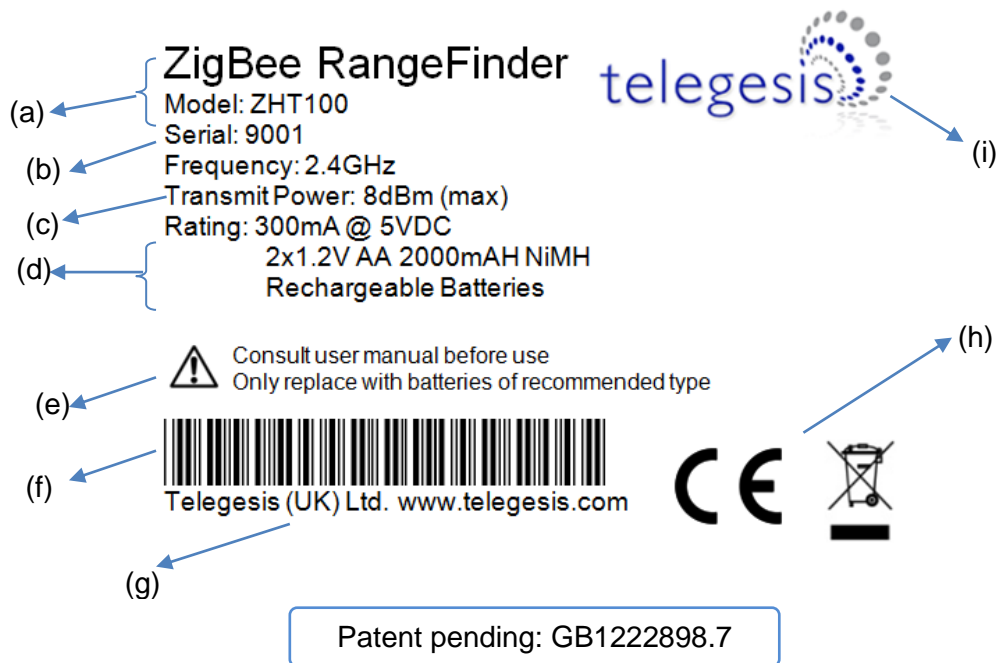

Figure 4: Product Label

#### Handheld Terminal Label

- (a) Product name “ZigBee RangeFinder” and product model number “ZHT100”
- (b) Serial number of the product
- (c) Operating parameters of the product
- (d) Maximum RF Transmit power
  - 8dBm for standard version
  - 20dBm for Long Range version
- (e) Warning
- (f) Barcode with following content:  
 <Model>/L<Serial>  
 e.g. ‘ZHT100/L9001’
- (g) Compliance marking for CE and WEEE

## Functionality

The Hand-Held Terminal (HHT) is the centre point of the system and all communication in the system is with respect to the HHT. The operator can set up parameters for tests, perform the tests and configure other test settings from the HHT. Below are the explanations of various options and output screens one can use on the HHT.

## Start-up:

Upon pressing the power button  for four seconds the following screen will be displayed. This screen has useful information about the product such as the serial numbers of device and the firmware version of HHT. This screen is displayed upon power up and by Device Info option on Menu screen 3.

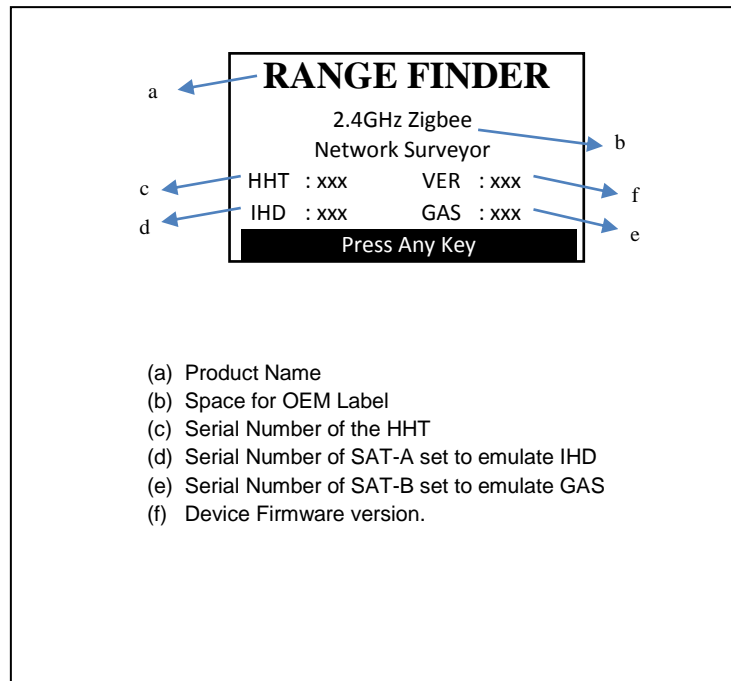







Figure 5: Start-up Screen

## Menu Screens:

Menu items can be scrolled through using the navigations keys    and  to navigate through options and press  button to enter the selected menu item. The battery symbol shows the current battery status.

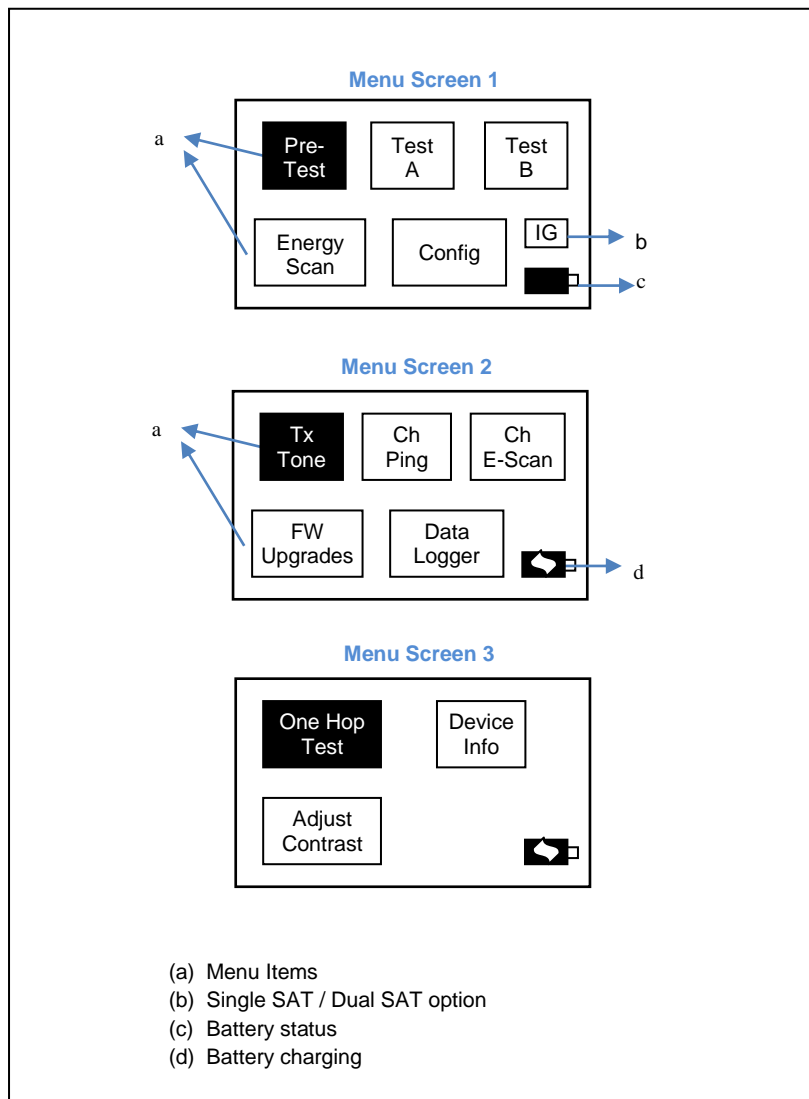
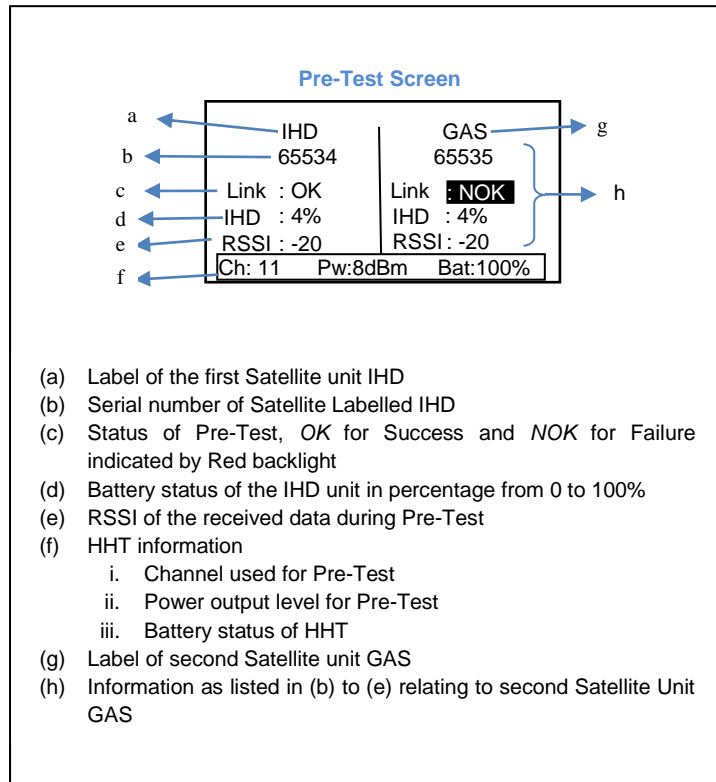

Figure 6: Start-up Screen

## Normal Test Modes:

### Pre-Test:

A Pre-Test is required before the 'Test A' or 'Test B' can be performed. The Pre-Test has the function of sanity checking the link between the HHT and the SAT units. Also performing Pre-Test will configure the current test settings in SAT units. A test carried out without running a Pre-Test may **NOT** present valid results. Any change in the Configuration settings should be followed by a Pre-Test.



**Figure 7: Pre-Test Screen**



The completion of the Pre-Test is indicated by a short beep from the built-in buzzer. To return to the main menu from the Pre-Test Screen please press 

**Test A / Test B:**

Telegesis Range Finder tests are designed to evaluate the suitability of deployment of a Smart Energy device which is why they focus on the ZigBee Smart Energy recommended RF channels in the 2.4GHz spectrum. Tests A and B are performed on ZigBee SE channels 11, 14, 15 and 19 during Test-A, while the remaining of SE channels 20, 24 and 25 are tested in Test-B.

Although the Rangefinder is designed to assist with ZSE installations, the [Continuous test](#) and [Energy scan](#) can be used to analyse the entire ZigBee 2.4GHz spectrum.

At the start of each test-A/B, countdown is activated to give a chance for the operator to put the HHT in place of simulated test device such as electricity meter and move away from the meter housing if necessary. This timer is configurable in the Configuration Menu.

To perform tests A or B, navigate to the menu item on [Menu Screen 1](#) using  and  keys and press  button for the test start screen to appear. Continuous and

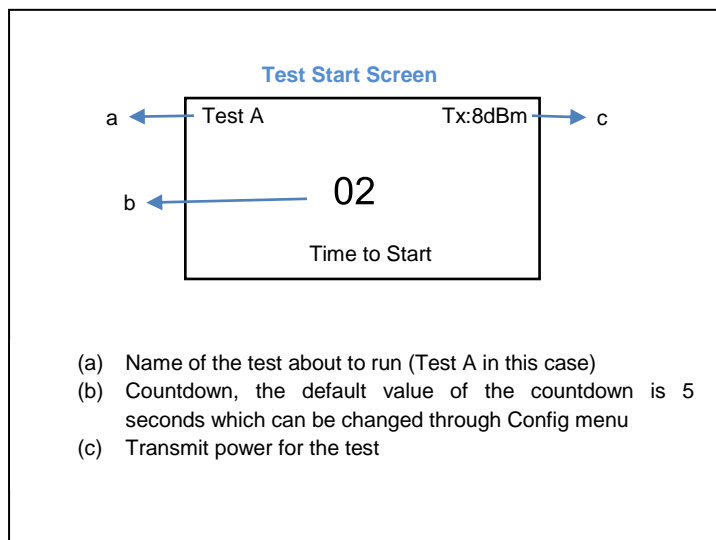

**Figure 8: Test Start Screen**

Once the countdown has elapsed, the test starts and the test results are displayed for each channel for the test as the test progresses. The completion of the test is indicated by a short beep from the built-in buzzer. The display backlight changes to Red for test failure and to Blue colour if the test is a pass. Also the failed values will be inverted. For details of the Pass/Fail criteria please see section "Interpreting Test Results".

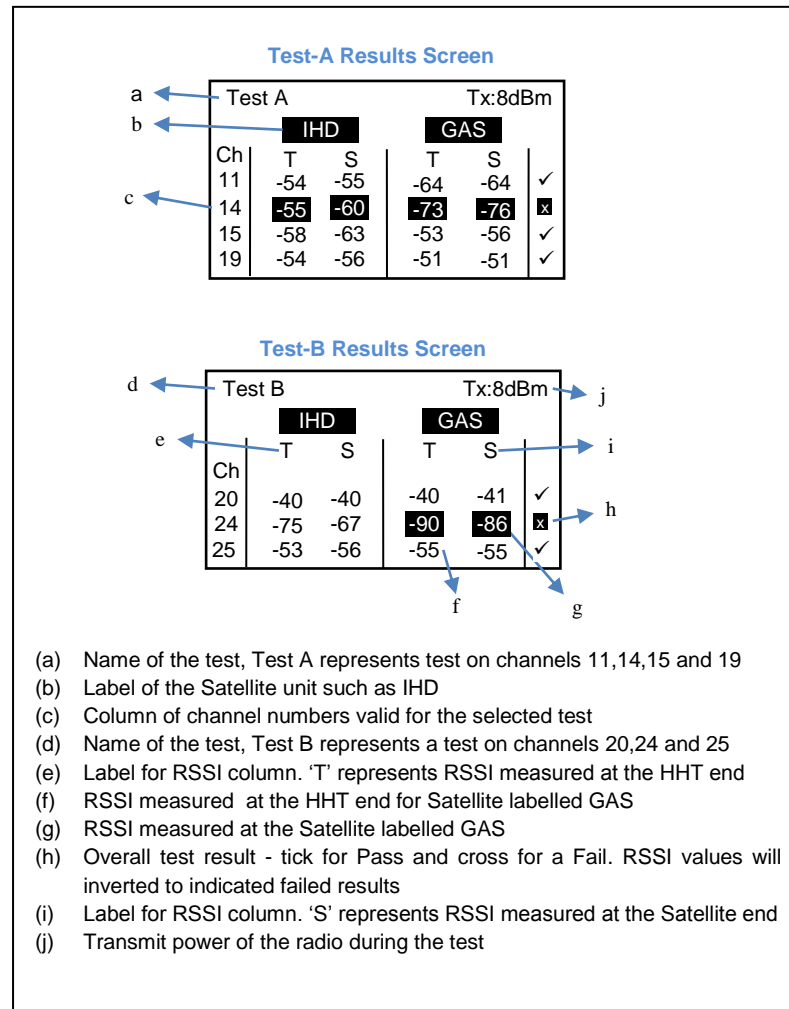





Figure 9: Screen for Test A and B

The completion of the Test-A/B is indicated by a short beep from the built-in buzzer. To return to the menu screen press 

**Energy Scan:**

The operator can make use of the Energy Scan of the network to get a measure of the noise or traffic present on a channel. Due to the dynamic nature of protocols (Wi-Fi, Bluetooth, ZigBee) each scan may show a different noise level even when done back to back. Each channel is scanned for noise for about 260mS. The results are painted for each channel as they become available.

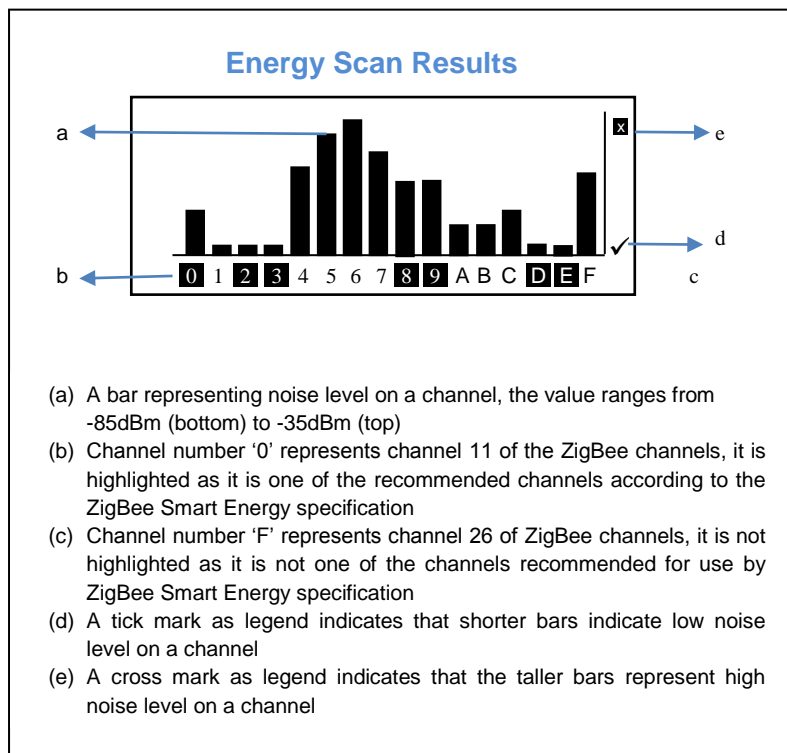

-35dBm is considered to be very noisy and -85dBm is considered very quiet. The channels preferred by the ZigBee Smart Energy standard are highlighted in the test results. A sample of the test screen is shown below. To perform the Energy Scan, navigate to the Energy Scan menu item on [Menu Screen 1](#) using  and  keys and press  for the energy scan result graph as shown below to appear on screen.



**Figure 10: Energy Scan Screen**

## Continuous Test Modes:

### Tx Tone

The Transmit Tone option can be useful in situations in which one has to test immunity of the existing ZigBee network against noise from other devices operating on the same channel. This option will transmit a continuous tone on the user selected channel and power level. To transmit a tone on a channel, navigate to the Tx Tone menu option on [menu screen 2](#) using  and  keys and press  for following screen to appear.

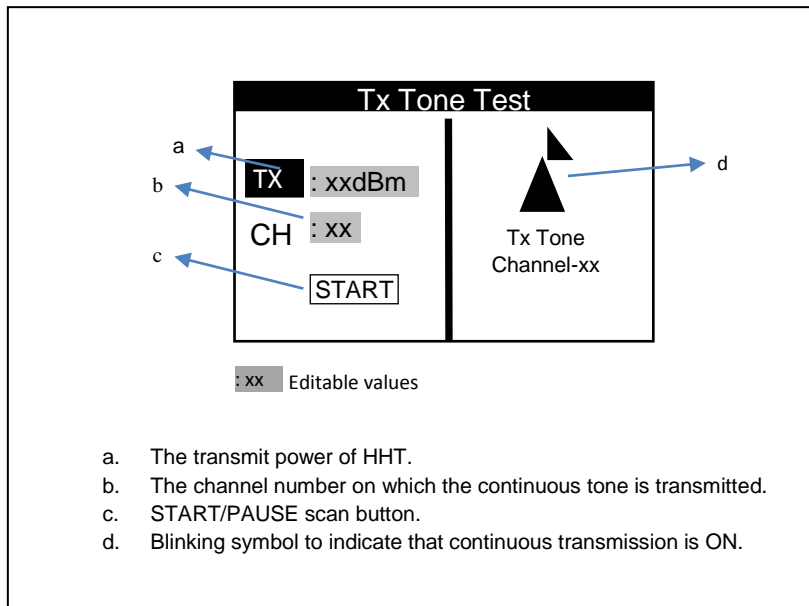









Figure 11: Tx tone

Once on this screen, the user can scroll through parameters using the  and  keys, press  to be able to edit the transmit power and channel number on which to transmit a continuous tone which can be done using the  and  keys and again press  to set the new value.

After setting all the parameters, user will navigate to START option and press  to start transmitting the tone. The symbol on the right will start blinking to indicate that the tone is being transmitted on the set channel.







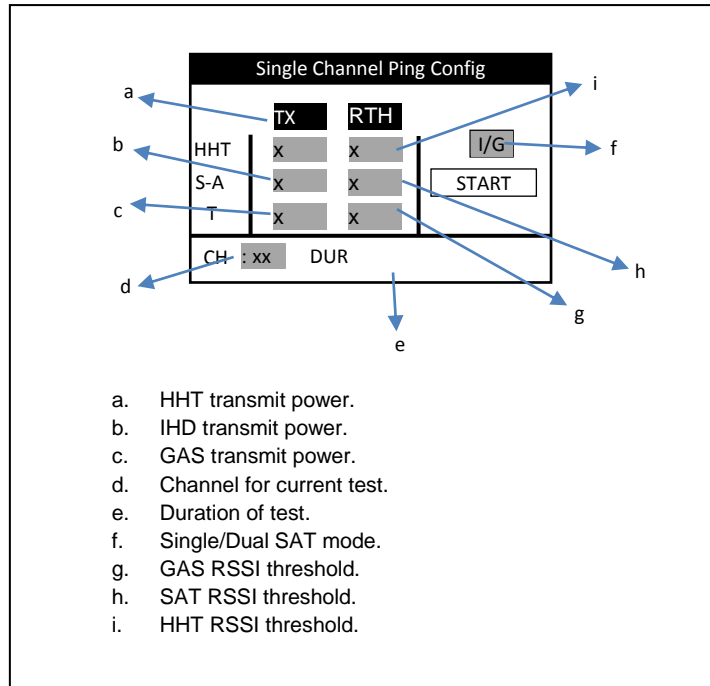



**Ch Ping**

This is another continuous mode tests which can be used whenever the user wants to find the best location to position the IHD and GAS units to get the optimum signal strength that can be achieved.



**Figure 12: Continuous Ping Configuration**

The main advantage of this test is the ability to set different test parameters such as Tx Power and RSSI threshold limits in all three (IHD; GAS and HHT) devices. This gives the operator flexibility to emulate different devices with different settings which can be the case in an actual ZigBee network.

This option can be used to measure the RSSI between the HHT and the IHD and/or GAS units. As with the other options navigate to the Ch Ping option on menu screen-2 using  and  keys and select the option using  key. The single channel Ping Config screen as shown above will appear. There are different parameters as shown in the figure above which are to be set according to test requirements. To scroll through list of parameters, use  and  arrow keys. Press  to edit,  and  to edit values and again press  to set the parameter value for the continuous Ping test to be performed.

Once all the parameter values are set press navigate to START and press **OK** to start the test. Now the test will run for the time in sec set for DUR parameter. If the time set is 0 then the test will keep on running and updating the display with the Single Channel Ping Results screen unless stopped manually by pressing **ESC** key.

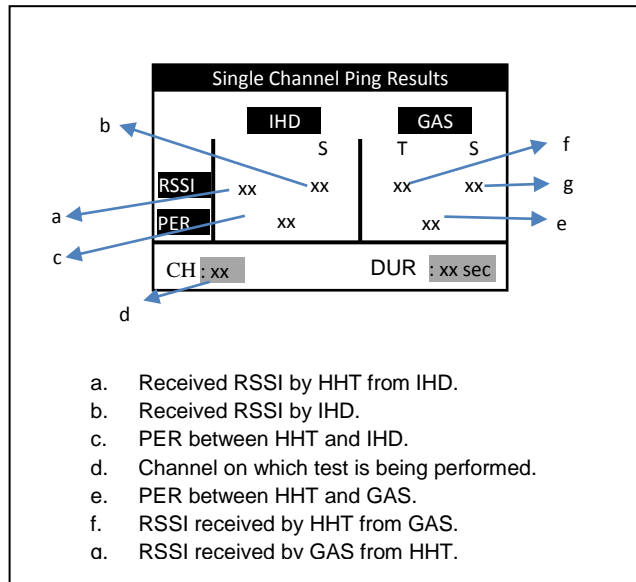





Figure 13: Continuous Ping Results

### Ch E-Scan

This channel scan will show the dynamic values of the current noise levels in the selected channel. To select this single channel E-Scan option, navigate to the option on menu screen 2 using  and  keys and press . The following screen will appear.

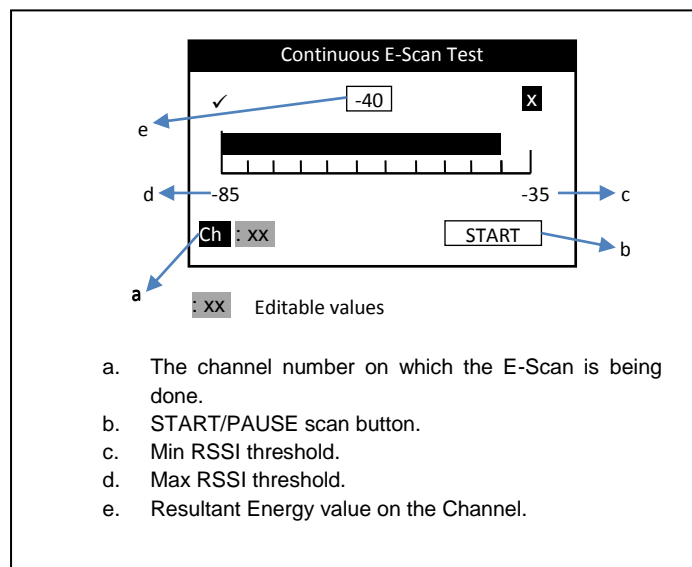











Figure 14: Single Channel E-Scan

Once on this screen, scroll through the list of channels (from CH-11 to CH-26) on which the noise scan is to be done by using  and  keys and again press  to set the desired channel. The scan is started by navigating to START and pressing . The dynamic energy levels on that channel will be displayed on the screen as shown in the figure above.

### One Hop Test

The One Hop test is a very useful test in systems that require a repeater in between two nodes. The IHD will operate as a repeater (RTR) between the HHT and GAS. All messages from the HHT which are directed towards GAS will be relayed by the RTR. This test will help finding the best possible location for the repeater to be placed and simultaneously tests the link between nodes through the repeater. The following configuration screen is displayed when the one hop test option is selected. The configuration screen allows the operator to modify the test parameters like Tx Power, RSSI threshold, Channel used for test and the duration of test. To scroll through list of parameters, use  and  arrow keys. Press  to edit,  and  to edit values and then press  to set the parameter value for the current session of test.

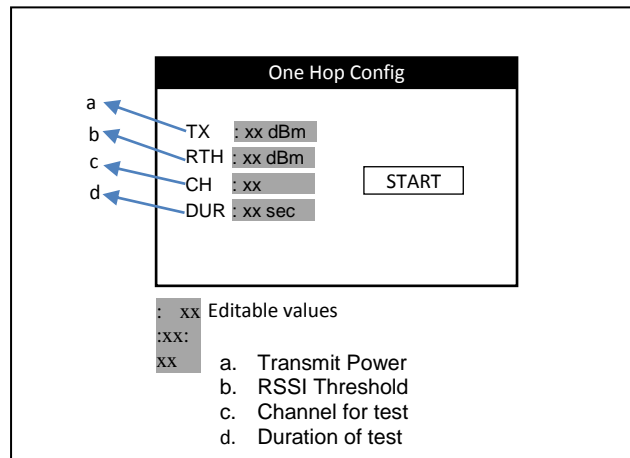



Figure 15 One hop configuration screen

Once parameters are set navigate to the start button on the screen and press  to start the test. At this point the one hop results screen as shown below will be displayed on screen. Depending on the test state one of the following result screens will be displayed.

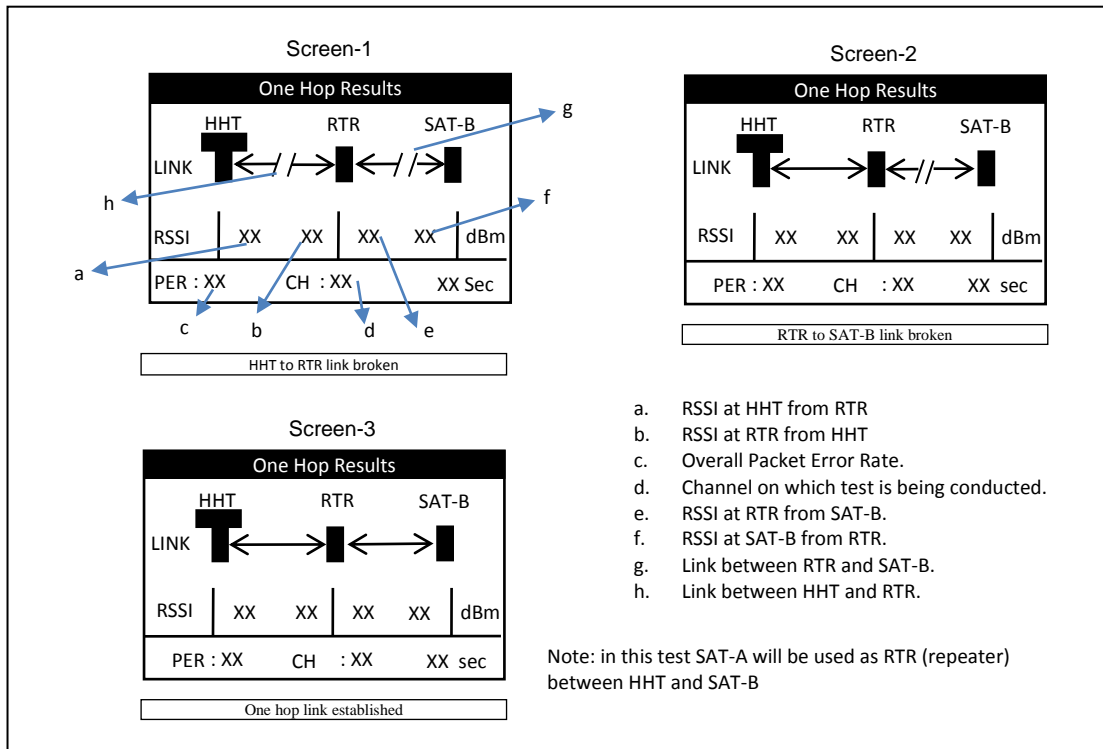

Figure 16 One Hop Test Result Screens

**Screen-1:**

This is the initialization state of the test when there is no one hop link established between HHT and GAS as shown in Screen-1. Initially when the devices (RTR or SAT) are out of range of the HHT or are not turned on the HHT cannot pass on the message to the GAS. Hence the link status shows a broken link between the HHT and RTR and GAS.

**Screen-2:**

The test will remain in the initialization state and periodically retry to establish the link (indicated by periodic beeps). To run the test, turn on the RTR and bring it closer to the HHT until you see Screen-2. When the HHT can communicate with RTR Screen-2 will be displayed which indicates that the link between HHT and RTR is established but the link between HHT and GAS is not established as the RTR cannot pass on the messages to the GAS. The HHT will try to continuously establish one hop link until successful when screen 3 is displayed.

**Screen-3:**





When Screen-2 appears, turn on the GAS and bring it closer to the RTR so that it can get the messages for the RTR. Once that happens Screen-3 will appear and the HHT will set the test channel on all devices and start pinging messages to GAS for the set test duration and update the RSSI values.

As the test is running the operator can move the devices to get a measure of the optimum range between devices. If any of the devices move outside the pre-configured RSSI limits or if some packets are missing the HHT will beep to indicate this and the operator can react accordingly.

To end the test press  key and the HHT will send a message to end the test on both RTR and GAS units. Until both units are in range the end message will not carry forward to GAS and the HHT will keep retrying which is indicated by periodic beeps on the HHT.

## Device Configurations:

### Single Satellite Configuration:



In some cases it may be necessary to run the test using only one Satellite unit. Such a situation might exist where only an electricity meter is being installed together with an IHD. In such cases it is possible to select the Satellite unit labelled IHD only to be used for test. To do so one has to go to the Home Screen and scroll to (using  and ) item **I G** and press keys  or  to select between **I** or **I G** and press  to save the setting. This setting is volatile and will revert to **I G** once the device is turned off.

**Configuration Settings:**

The Configuration Settings are the important device settings that are used by the HHT and SAT units while performing the tests. The Telegesis Range Finder is designed to be able to simulate any actual ZigBee SE device – such as IHD’s, GAS meters, ESI’s etc. All these devices may operate at different power levels and may be able to operate at different RSSI thresholds in an actual SE network. The Configuration Settings menu provides the way to introduce different settings for different devices settings at the time of test.







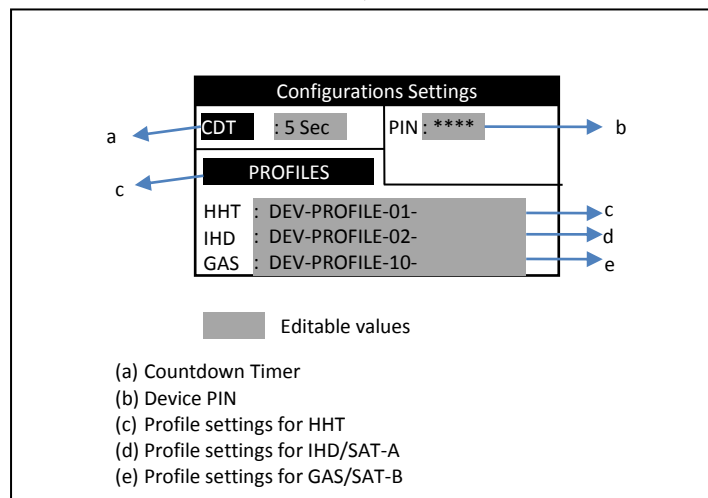

There are 10 pre-stored device profiles that can be used by the operator on site. The values within these settings cannot be changed without inputting a PIN number which is a 4 digit code. This pass code can be restricted to authorised technicians to prevent accidental entering of incorrect parameters by the operator in the field.

The Configuration Settings screen provides options for the user to change the test parameters.

The Operator can navigate through the options using  and  keys may press  to modify a setting. The Configuration screen is shown below,



**Figure 17: Configurations Screen**

- (a) The Countdown Timer value is set to a default of 5 seconds; the operator can change it to values between 10 and 120 seconds. The change made is volatile and will revert back to the default value<sup>1</sup> after power-off.
- (b) A four digit PIN code allows access to advanced settings. The factory programmed PIN code is 1985 which can be entered using keys , ,  and  and submitted using the  key. This PIN can be reset to default or changed to a new PIN via a serial command.
- (c) The Operator can select the configurations settings from previously stored settings. Memory required for 10 profiles reserved in non-volatile memory. These profiles can be edited and stored by PIN protected serial commands. To set configuration a particular settings from a particular profile and navigate to the profile for device using , , and then press . Then scroll through list of profile and press  to set the device with settings from selected profile.

<sup>1</sup> The default CDT value can be changed in the advance configuration settings.







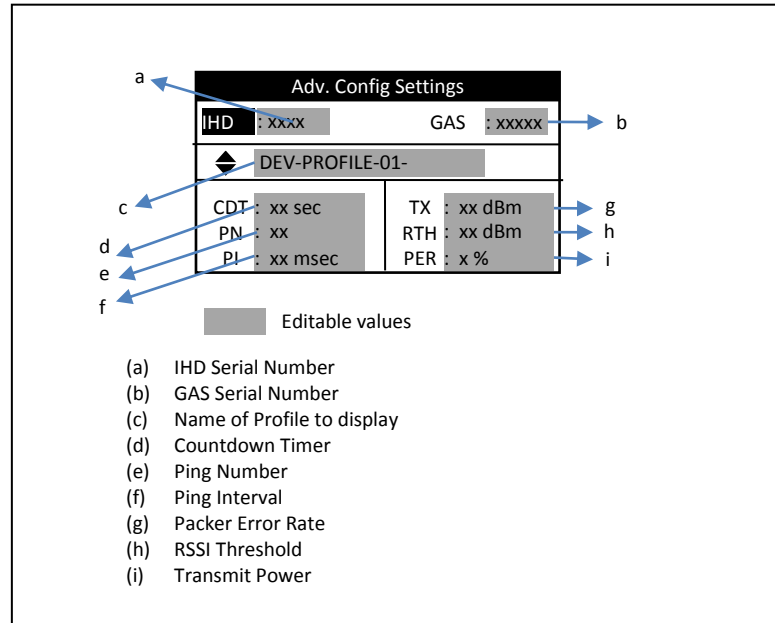







**Advanced Configurations Settings:**

The Advance Configurations Settings Screen is visible only after entering the correct device PIN.



**Figure 18: Advanced Configurations Screen**

To display the settings of different profiles stored in the HHT navigate to the Profile section using  and  keys, then use  and  keys to scroll through the 10 profile settings stored into HHT. To change a particular parameter of the displayed profile use keys ,  to navigate to the parameter and then press  to start modifying it using keys , ,  and , and press  to save the settings. To cancel the changes while modifying press . The parameters are explained below.

- (a) IHD Serial: Serial number of Satellite unit labelled as IHD. Only the Satellite with matching serial number will be used in the test.
- (b) GAS Serial: Serial number of Satellite unit labelled as GAS. Only the Satellite with matching serial number will be used in the test.
- (c) Profile Name: Is the name of the profile out of the 10 stored profiles, whose settings are currently displayed on screen.
- (d) Countdown Timer: This is the default setting of the Countdown time which is non-volatile and will be used each time the unit is turned on. The valid limit for the timer is 5 to 120 seconds.

- (e) Packet Number: Number of packets to be sent to a Satellite on a given channel during the test, the selection is available between 50 to 100 packets and can be changed in steps of 5 packets.
- (f) Packet Interval: The time gap between two consecutive packets sent during a test. The minimum interval can be 10mS and the maximum is 25mS and can be changed in steps of 5mS.
- (g) TX Power: Transmit power level while sending the packets, the power setting available is from +8dBm to -9dBm in steps of 1dBm for standard version of Range Finder and values of 20,19,18,16,15,13,10,7,1 dBm for long range version
- (h) Receive Threshold: The minimum receive signal strength for a packet to be considered valid for test purpose. The limit available is -85dBm to -45dBm changeable in steps of 1dBm.
- (i) Packet Error Rate: Maximum allowed packet error rate for a successful test. The limits are 2% to 10% maximum - changeable in 1% steps.

Label	Parameter	Minimum Value	Maximum Value	Change Steps
<b>CDT</b>	Countdown Timer	5 Seconds	120 sec	1 sec
<b>IHD</b>	IHD Serial	0000	65535	1
<b>GAS</b>	GAS Serial	0000	65535	1
<b>PN</b>	Packet Number	50	100	5
<b>PI</b>	Packet Interval	10mS	25mS	5mS
<b>TX</b>	TX Power	-9dBm	8dBm	1dBm
<b>RTH</b>	Receive Threshold	-85dBm	-45dBm	1dBm
<b>PER</b>	Packet Error Rate	2%	10%	1%

Figure 19: Configurations Parameter Limits

The mechanism by which the above parameters affect the testing is explained in the section “Interpreting Test Results”.

### Firmware Upgrades:

The Telegesis Range Finder comes with an Over-The-Air (OTA) Bootloader. This enables the HHT to upgrade its own firmware via the USB link and also remotely upgrade the firmware of the SAT units. The Firmware Upgrades function is PIN protected for security.

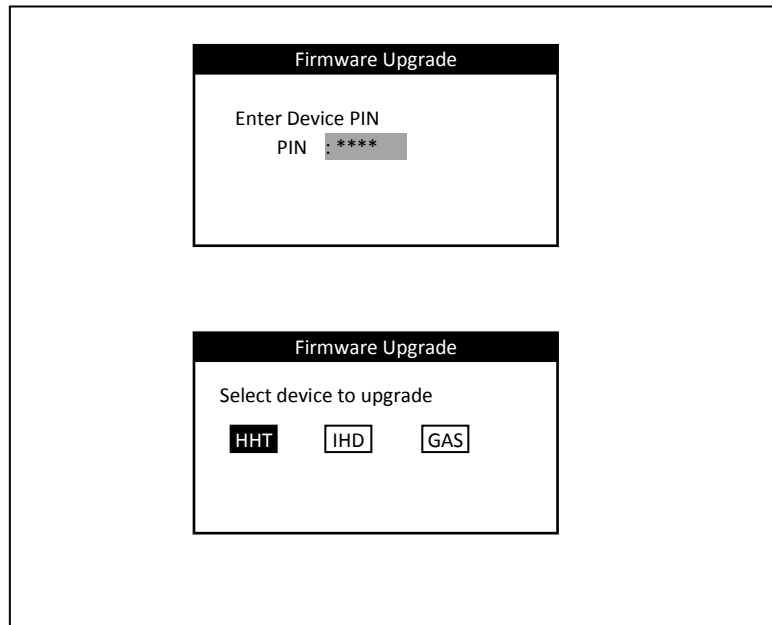



Figure 20 Firmware Upgrade Screens

Once the device PIN is entered correctly the Firmware Upgrade screen will give the options to select a device to perform the upgrade.

### Upgrading the HHT unit:

Select the HHT unit for upgrade by navigating to it and pressing  key. That will start the bootloader in serial mode and the new firmware image can be transferred via Xmodem at 115200 8N1 baud using the Telegesis Terminal or any other terminal program that supports Xmodem. The display on the HHT unit will show the following screen and the backlight will start to blink with red and green lights indicating that the bootloader is active and waiting for new firmware image.

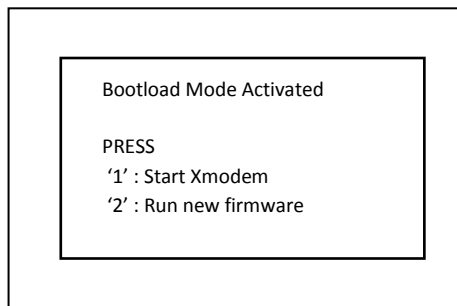
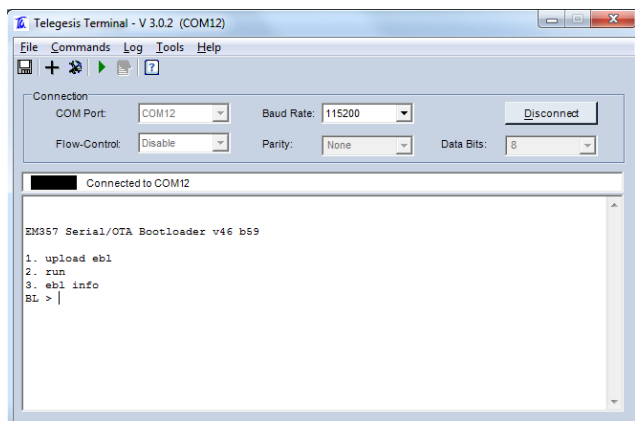

Figure 21 HHT Firmware Upgrade

- Now Press Enter key on host PC to get the bootloader options on the terminal as shown in the fig->



- To upload the new firmware image press '1' on the host PC, which will put the bootloader in Xmodem receive mode.
- Indicated by outputting 'C' on the terminal as shown in the fig->.
- Now Transfer the new firmware \*.ebl file to the HHT unit.
- Once the file is transferred press '2' on host PC to run the new firmware.

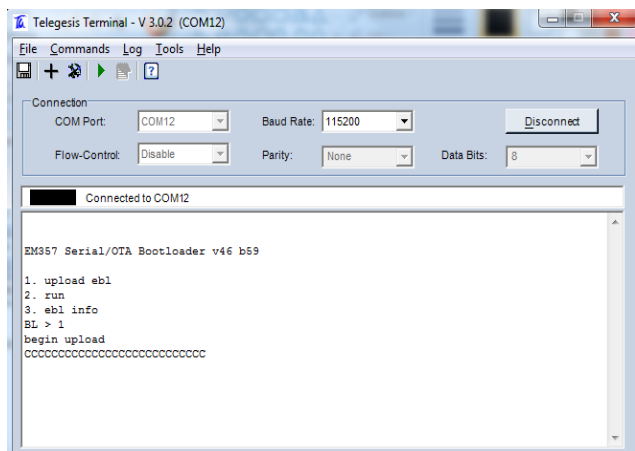
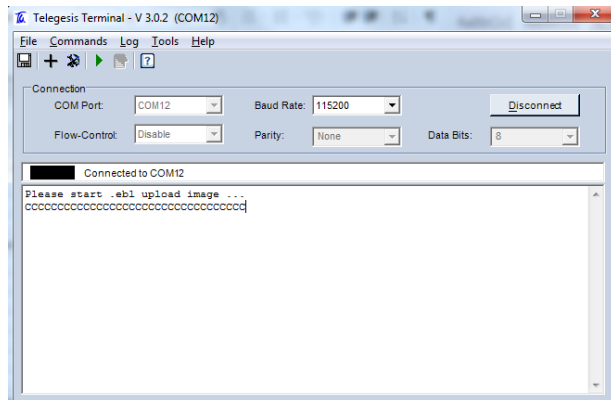

Figure 22 HHT Firmware upgrade options

**Upgrading the SAT units:**

It is possible to perform OTA firmware upgrades of the SAT units. The upgrade image (\*.ebl file) will be passed to the HHT to send it across to the SAT unit. Select the IHD/GAS unit for upgrade by navigating to the particular option on the Firmware Upgrade Screen and press **OK** key. That will start the bootloader in OTA pass-through mode and the new firmware image can be transferred to the remote IHD or GAS unit over the air via HHT unit using Xmodem protocol at 115200 baud 8N1.

- When the remote SAT unit is selected for OTA firmware upgrade, the red LED starts flashing continuously.
- And the HHT outputs 'C' as shown in fig-> the terminal indicating that it expects the image to be transferred to SAT unit.
- Transfer the firmware upgrade \*.ebl file to the HHT using Xmodem and the HHT will send it to the remote SAT unit.
- When the new firmware image is being transferred the red LED on the SAT unit stops blinking and the green LED starts flashing.



- If for any reason (eg. Battery on SAT dying while transfer of file or ZigBee link broken), the SAT unit will remain in the same bootload mode with red LED flashing. The HHT will timeout after 30 sec and send out a message on the terminal as shown in fig->
- The entire file needs to be transferred again to the SAT unit.

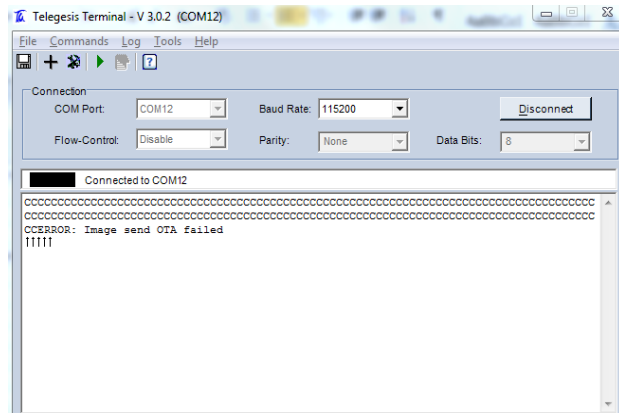

**Figure 23 SAT Firmware Options**

### Data Logging:

The test results of Test-A/B and Energy scan results will be automatically logged into an on-board serial flash of 8Mbits if the data logging feature is included into the device. The results will be stored along with the device configurations settings at the time of test. The Data Logging screen will pop up at every turn-on just after the Start-up screen to give a chance for user to enter the site ID before the start of tests. This screen can also be accessed via the data logger option on [menu screen 2](#). The logger will start with a new record and increment record counter every time the site ID is changed.

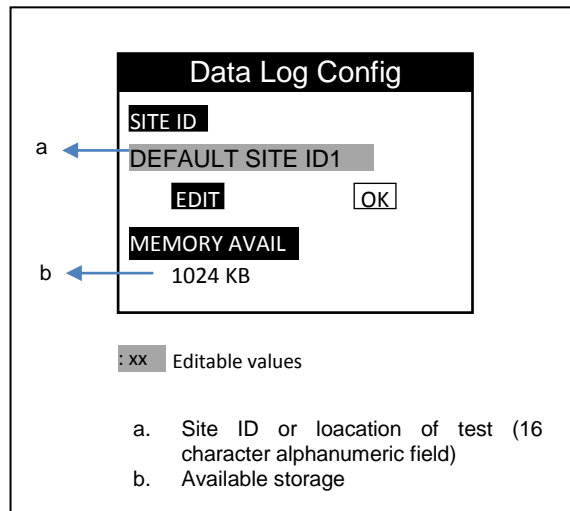

Figure 24 Data Logger Screen

### Record Main Header

The record header will be of following type:

```

//Record size
int16u recordSize;
//Main record header
typedef struct {
    int8u recordSiteId[16];
    int16u recordMainNumber;
}recordMainHeader;

```

Where,

**recordSize** – This is the total size of data collected at each site location. recordSize is the addition of the recordMainHeader bytes; recordSubHeader bytes; records. Since there can be any number of tests performed at any given site, the recordSize is variable hence it is calculated at the end of the last test carried out at the site (i.e. when the new site ID is entered by the user). But it is stored at the start of each record before the site ID in order to make scan through records faster.

**recordMainHeader** – This is the main record header at the start of each set of records collected at new site location.

**recordSiteID[16]** – This will be an 16 byte field used to store the site ID which will be entered by the user manually through arrow keys on the HHT. The first 8 bytes of the Site ID will be fixed and can be used as a Start Of Record (SOR) pointer.

**recordMainNumber** - It can be the Record ID or just a simple record counter which increments after each record stored in the flash. This number will increment when the test is done at new site location.

## Record Sub Header

```
//Sub Record Header
typedef struct{
    int8u recordSubNumber;
    int8u recordType;
    int8u recordLength;
    testSettings
    recordTestSettings;
}recordSubHeader;
```

**recordSubHeader** – This header will be at the start of each individual record for a test conducted at same site location.

**recordSubNumber** – The value recordSubNumber will indicate the record number for the current site and will increment after each test performed at the same site.

**recordType** – The one byte recordType identifier which will indicate which type of test results is stored in the record field.

**recordLength** – This value will be the actual length of the record excluding the record header bytes as the record header will be of fixed length.

**recordTestSettings** – This will be the configuration settings set in the HHT at the time of current test.

## Record Structures

### Test A record

**Sub Header**  
recordType – 0x01  
recordLength – 28  
recordTestSettings –

```
//testSettings for Test A and Test B
typedef struct{
    int8u PingNumber;
    int8u PingInterval;
    int8u perThreshold;
    int8s transmitPowerHHT;
    int8s transmitPowerA;
    int8s transmitPowerB;
    int8s rssiThresholdHHT;
    int8s rssiThresholdA;
    int8s rssiThresholdB;
}testSettings;
```

### Record data

```
//test Records for Test A
typedef struct{
    int8u satARssi [4][2];
    int8u satBRssi [4][2];
    int8u perA[4];
    int8u perB[4];
    int8u testResult[4];
}recordTestARecords;
```

Column-0 – RSSI received at the SAT- A or GAS end

Column-1 – RSSI received by HHT

Row-0 – CH11 result

Row-1 – CH14 result

Row-2 – CH15 result

Row-3 – CH19 result

### Test B record

#### Sub header

recordType – 0x02

recordLength – 21

#### Record Data

```
//test Records for Test B
typedef struct{
    int8u satARssi[3][2];
    int8u satBRssi[3][2];
    int8u perA[3];
    int8u perB[3];
    int8u testResult[3];
}recordTestBRecords;
```

Column-0 – RSSI received at the SAT- A or GAS end

Column-1 – RSSI received by the HHT

Row-0 – CH20 result

Row-1 – CH24 result

Row-2 – CH25 result

### Energy Scan Record

recordType – 0x03

recordLength – 16

#### Record Data:

```
//test Record for Test B
typedef struct{
    int8u energy[16];
}EScanRecords;
```

The energy results array will hold the values of Energy scan on all the ZigBee channels 11-26



## Device Info

This menu option displays the device information like the firmware version and serial numbers of the SAT units paired to the HHT unit.

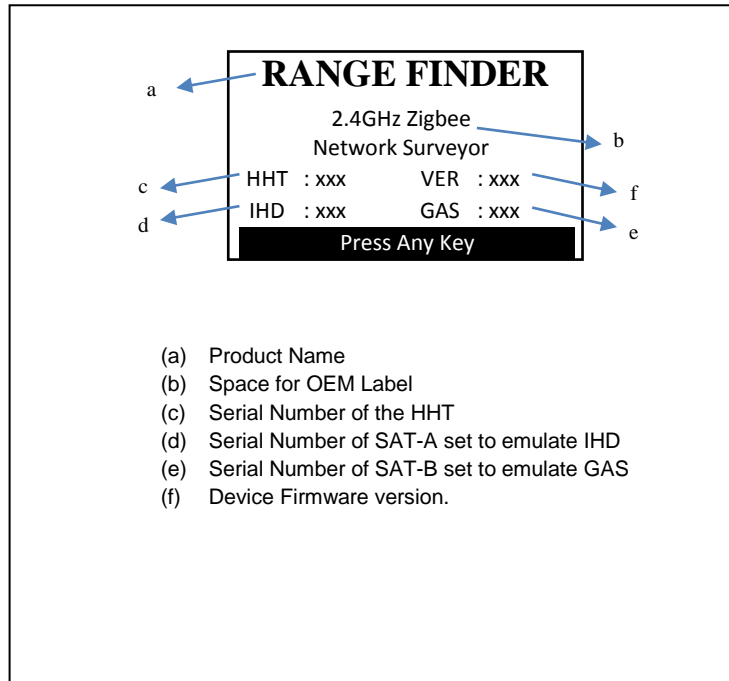





Figure 25: Device Information Screen

## Adjust Contrast

This menu option lets user adjust the contrast of the screen by using  and  keys. After adjusting to the required contrast level press  to apply the contrast. The HHT will beep once to indicate that the contrast is applied.

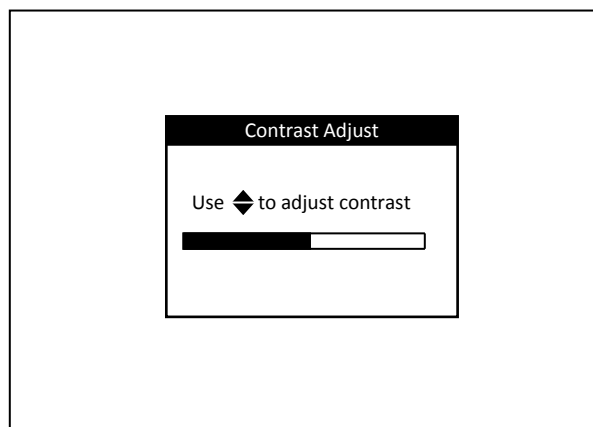

Figure 26: Adjust Contrast Screen

## PAN Scan

The Rangefinder handheld unit can continuously scan for ZigBee PANs at site. The PAN scan can either be performed on a particular channel or on all 16 ZigBee channels.

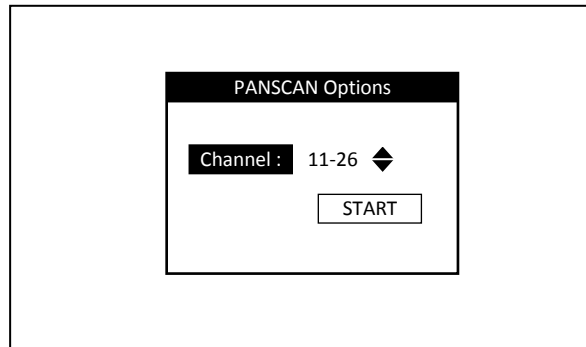







Figure 27 PAN scan options

The menu option shown above lets the user select the channel for PAN scan and start the scan. To navigate through the Channel and START option use  and  keys. Once the channel option is selected use  and  keys to scroll through the channel list. If 11-26 option is selected the PAN scan will be performed over the entire ZigBee spectrum. After selecting the channel press  to apply the channel and press START. The PAN scan will start and any PAN's discovered during the scan will be added to the screen shown below.

**PAN Scan results screen**

PAN's found: 1 of 3					
CH	PANID	JN	JC	RS	W
19	745F	Y	2	-43	I
20	6678	Y	2	-12	I
24	ABCD	N	0	-23	
18	C234	N	2	-75	

CH – ZigBee Channel number for the PAN found  
 PANID – PAN Id of the PAN found  
 JN – Permit join state of the PAN found  
     Y if permit join is true  
     N if permit join is false  
 JC – Join counter which increments each time the permit join state changes from N to Y  
 RS – RSSI value of the PAN  
 W – Join window which changes its state automatically 2.5 minutes after the permit join status changes from N to Y

Once the PAN scan is started handheld unit will continuously scan and update the information about PANs found on the screen. As many as 50 PANs can be discovered using this tool. The PAN list will update dynamically when the new PAN is found. The network found with permit join true is given higher priority in the list and will sit at the top of the list.

**Pan change indications**

- Once a new network is found with permit join true OR if an existing network changes its permit join state from N to Y, the HHT will beep 5 times and flash blue backlight for indication.
- If a new network is found with permit join false, it will be added to the list just after the existing PANs with permit join true, there will not be any indication for the new network found with permit join false, however if an existing network changes its state from Y to N, a long beep of 5 sec along with red backlight flash will indicate this change.
- After 2.5 minutes of permit join turning to Y the join window indicator will turn ON and HHT will beep 5 times and flash blue backlight just as when a new PAN with permit join is detected to indicate that the permit join is still true on the network to make the operator aware of extended join window opening.

## Power

The HHT is powered by rechargeable NiMH batteries which are charged through the USB connection.

## Batteries

The unit takes two 1.2 V 2000mAh NiMH batteries. To conserve the power consumption the unit will turn itself off after a period of inactivity. The battery compartment is accessible on the back side of the HHT and can be opened using a coin as shown in the Layout section. The battery compartment is designed to take 3 AA cells hence the extra space is blanked off using a dummy pass-through AA cell which should not be removed. The battery state is shown on the Home screen using the following symbol,



Figure 28: Battery Symbol

The above symbol is showing 50% battery charge remaining.

## Charging

The HHT can be charged or powered using the USB port connection. The USB connector is a USB “B” Micro socket. The detection of the USB power source is indicated by a beep from the built-in buzzer. The HHT does not go to sleep while it is powered from USB power source. The charger charges the 2000mAh batteries at C/10 rate and it terminates the charge via voltage detection and a 12 hour timer. The power requirement for charging as well as operating the unit is 1.5Watts at 5 Volts. The charging state is shown on the Home screen by showing the following the symbol,



Figure 29: Battery Charging Symbol

The charging symbol shown above is replaced with the battery capacity remaining symbol as shown in Figure 28: Battery Symbol once the charging is finished.

## Power Saving

The HHT incorporates several ways to reduce power consumption and extend battery life. Most of the power is consumed by the LED backlight for the screen so it is important to turn off the backlight when not needed; the backlight is turned off in the following instances:

- a) No key press by the operator for 10 seconds
- b) 60 Seconds after a test has been completed

Moreover the unit is turned off after a period of inactivity of 15 minutes to save power. This 15 minutes is counted from the time the unit is turned on using the  ON/OFF and will be extended by 5 minutes if the user presses a key or a test is underway and the unit is in the last 5 minutes of the 15 minute wake period.

## Satellite Unit

### Layout

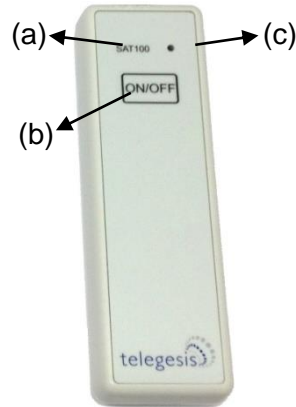

Figure 30: Satellite Front

- (a) Model number: SAT100
- (b) Power Button to turn the unit On or Off
- (c) Red/Green LED to indicate the operation state of the unit

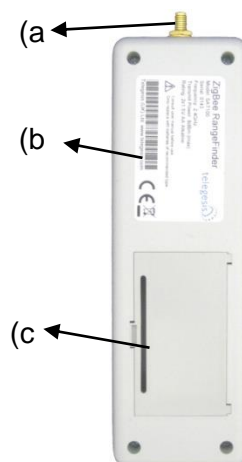

Figure 31: Satellite Back

- (a) SMA connector for Antenna
- (b) Product Label
- (c) Battery Compartment



**Figure 32: Satellite Product Label**

- (a) Product name
- (b) Module number of Satellite (SAT100)
- (c) Serial number of the product
- (d) Operating parameters of the product
- (e) Warning
- (f) Barcode with following content:  
 <Model>/L<Serial>  
 e.g. 'SAT100/L157'
- (g) Manufacturer's contact information
- (h) Compliance marking for CE and WEEE
- (i) Manufacturer's logo

## Functionality

The Satellite units (IHD/B) are always listening to commands from the HHT to which they are paired to and respond with the information required to calculate the results for various tests performed by the HHT. There is an ON/OFF button for power ON/OFF and status LED's for SAT activity indication.

## Buttons

There is only button on the Satellite which is the Power Button as shown in Figure 30. The Power Button needs to be pressed down for 3 seconds for it to take effect. When the Power Button is pressed, the LED indicator turns to solid RED colour and then turns off completely if the power is switched off or changes to flashing Red or Green if it is turned on.

## LEDs

The indicator LED has two colours and it can represent following states for the Satellite.

Red LED	Green LED	Satellite State
<b>ON</b>	<b>OFF</b>	Power Button is pressed.
<b>OFF</b>	<b>Flashing 1 flash/sec</b>	SAT unit ON and Battery State healthy.
<b>Flashing 1 flash/sec</b>	<b>OFF</b>	SAT ON and Battery Low.
<b>Flashing 2 flash/sec</b>	<b>OFF</b>	SAT unit waiting for upgrade image.
<b>ON</b>	<b>Flashing 2 flash/sec</b>	SAT receiving new image from HHT

Figure 33: Satellite LED States

## Power

### Batteries

The Satellite is powered by two 1.5 V AA Alkaline batteries. The battery state is indicated by the flashing Red for low and flashing Green for good battery state. The percentage battery capacity remaining is also sent to the HHT as part of the Pre-Test and is shown on the Pre-Test screen (see Figure 7).

### Power Consumption

To conserve the power the Satellite units are turned off after 15 minutes of wakeup period. If the Satellite receives any radio message from the HHT in the last 15 minutes of the wakeup period then it extends the wakeup period by 5 more minutes.

Nominal power consumed by the Satellite while it is turned on is 100mW.

## Usage

### System Topology

In a typical ZigBee Smart Energy installation it is expected the Electric and Gas meter will always be static whereas the IHD can move around. It is also expected that in some cases there will be no Gas meter present. This gives us the Electricity meter as a static element which will always be present. In many cases this is also the ESI for the Smart Energy network. The HHT is the centre point of the ZigBee RangeFinder and all the measurements are made with respect to the HHT, hence it makes sense to put the HHT in place where the Electricity meter will be installed and place the two Satellites in location where IHD and Gas meter are expected to be placed. A typical setup is shown below,

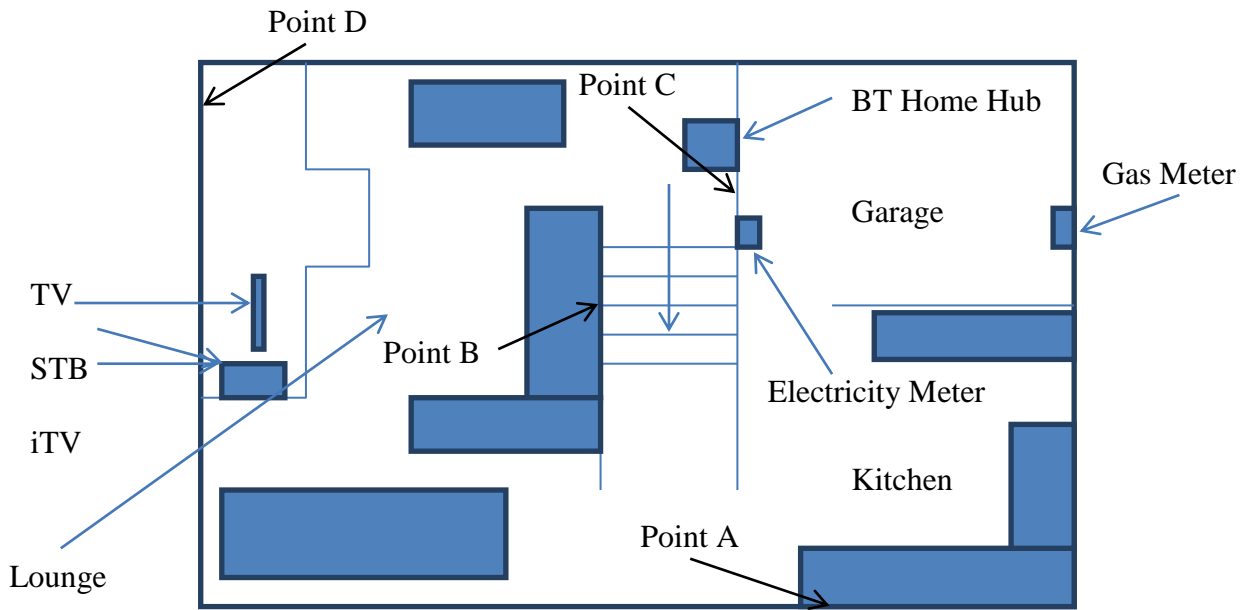

**Figure 34: A typical floor plan with Smart Energy equipment locations**

The Electricity and Gas meter locations are fixed whereas the IHD can be in any location such as indicated by points A,B,C and D in the above floor plan.



**Figure 35: RangeFinder locations: Electric meter, Gas meter and Kitchen work surface**

In the above picture the HHT is placed adjacent to the Electricity meter; the Satellite unit labelled GAS is placed on the GAS meter and the Satellite unit labelled IHD is placed on the kitchen work surface. The tests are then run on the HHT to make sure that all simulated devices will be able to communicate with each other.



## Workflow

The following flowchart shows the expected procedural flow for performing a test.



Figure 36: Workflow

## Interpreting Test Results

The RF over-the-air transmission mechanism, verified by observation, suggests that given a large enough sample size of RF packets the RSSI value does not change any more than a few dBm provided that the physical environment around the test units does not change during the test. If there is RF interference present during the test then it is more likely to cause failure of the packets to be received, decoded properly or a failure to pass the CRC test than to affect the RSSI value. Hence, it is important to take into account both RSSI values as well as Packet Error Rate when deciding the quality of the link.

A high number of packets (e.g. 50 packets 10millisecond apart) will be sent to the Satellite units from the Handheld unit which will echo the packets back and the results of the echoed-back packet will be used to calculate the *RSSI* , *PER* and eventually a PASS or FAIL result.

### RSSI Calculation

The RSSI calculation is a mixture of Median and Mode and will be calculated as follows,

$n$  = number of RSSI samples taken

$S_n$  = value of  $n$ th RSSI sample

$e$  = error margin (dBm)

\*  $n$  samples will be taken and  $S_n$  stored in memory

\* For each unique ' $S_n$ ' the occurrence of ' $S_n \pm e$ ' will be calculated and the highest occurring value shall be used as the *RSSI* value

### Packet Error Rate

An ' $n$ ' number of packets will be sent ' $t$ ' seconds apart

Responses will be received and counted against the number sent

A packet error rate (*PER*) will be calculated in terms of percentage packet loss

### Pass/Fail Criteria

For a Pass the *RSSI* and *PER* parameters needs to be following,

- 1)  $NUM\_BAD\_RSSI\_VALUES < RSSI\_BAD\_NUM\_THRESHOLD$
- 2)  $RSSI > RSSI\_THRESHOLD$
- 3)  $PER < PER\_THRESHOLD$

Where:

The *NUM\_BAD\_RSSI\_VALUES* is the total number of packets received with an RSSI value of less than *RSSI\_THRESHOLD*

The *RSSI\_BAD\_NUM\_THRESHOLD* is 10% (factory default) of total packets sent ' $n$ '

The *RSSI\_THRESHOLD* is -85dBm as factory default

The *PER\_THRESHOLD* factory default value is 10%

The above parameters can be changed from their factory default to user-specified in the Advanced Config menu.

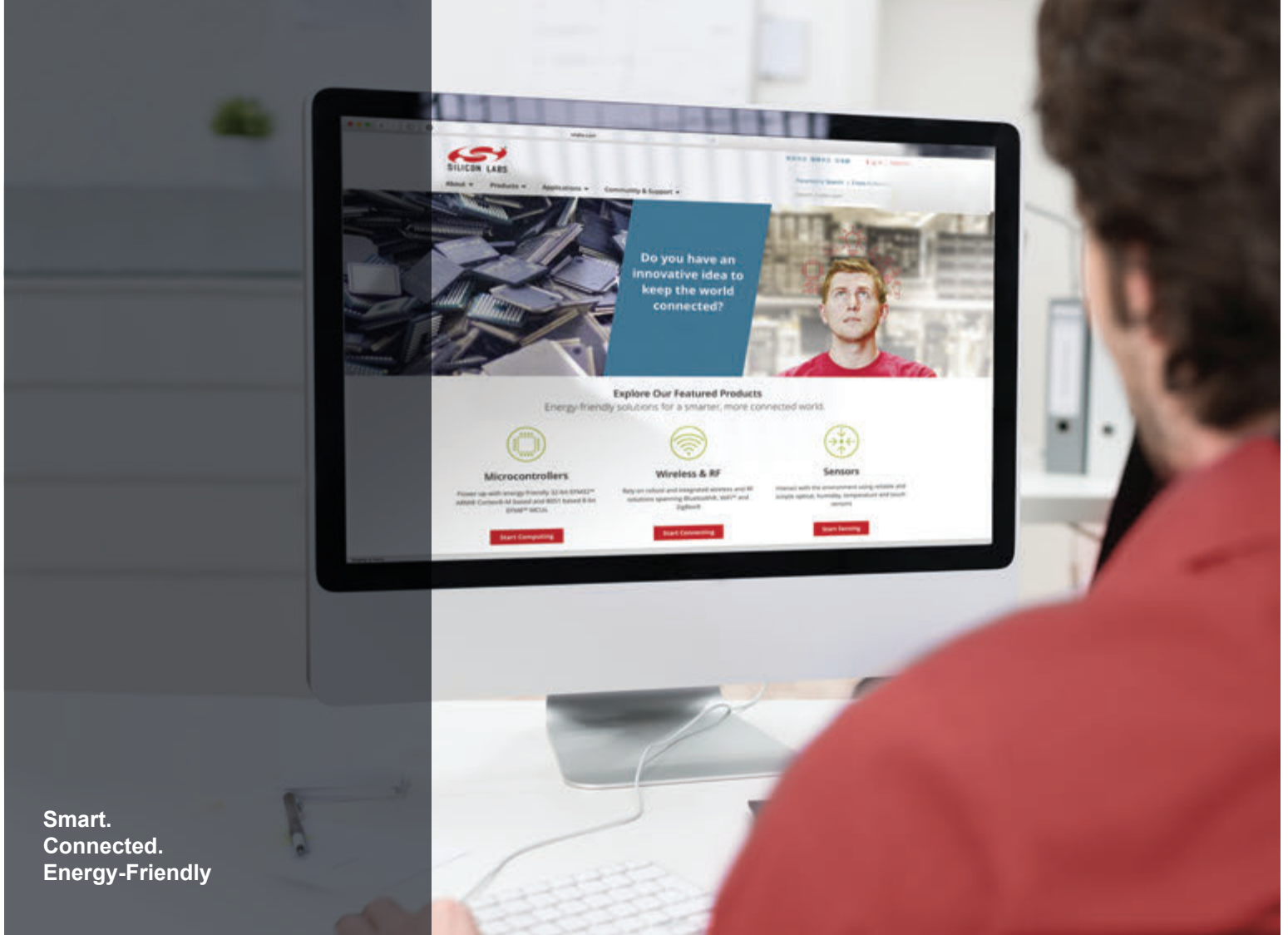

Smart.  
Connected.  
Energy-Friendly



**Products**  
[www.silabs.com/products](http://www.silabs.com/products)

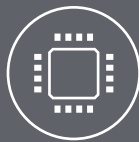

**Quality**  
[www.silabs.com/quality](http://www.silabs.com/quality)



**Support and Community**  
[community.silabs.com](http://community.silabs.com)

**Disclaimer**

Silicon Laboratories intends to provide customers with the latest, accurate, and in-depth documentation of all peripherals and modules available for system and software implementers using or intending to use the Silicon Laboratories products. Characterization data, available modules and peripherals, memory sizes and memory addresses refer to each specific device, and "Typical" parameters provided can and do vary in different applications. Application examples described herein are for illustrative purposes only. Silicon Laboratories reserves the right to make changes without further notice and limitation to product information, specifications, and descriptions herein, and does not give warranties as to the accuracy or completeness of the included information. Silicon Laboratories shall have no liability for the consequences of use of the information supplied herein. This document does not imply or express copyright licenses granted hereunder to design or fabricate any integrated circuits. The products are not designed or authorized to be used within any Life Support System without the specific written consent of Silicon Laboratories. A "Life Support System" is any product or system intended to support or sustain life and/or health, which, if it fails, can be reasonably expected to result in significant personal injury or death. Silicon Laboratories products are not designed or authorized for military applications. Silicon Laboratories products shall under no circumstances be used in weapons of mass destruction including (but not limited to) nuclear, biological or chemical weapons, or missiles capable of delivering such weapons.

**Trademark Information**

Silicon Laboratories Inc.®, Silicon Laboratories®, Silicon Labs®, SiLabs® and the Silicon Labs logo®, Bluegiga®, Bluegiga Logo®, Clockbuilder®, CMEMS®, DSPLL®, EFM®, EFM32®, EFR®, Ember®, Energy Micro, Energy Micro logo and combinations thereof, "the world's most energy friendly microcontrollers", Ember®, EZLink®, EZRadio®, EZRadioPRO®, Gecko®, ISModem®, Precision32®, ProSLIC®, Simplicity Studio®, SiPHY®, Telegesis, the Telegesis Logo®, USBXpress® and others are trademarks or registered trademarks of Silicon Laboratories Inc. ARM, CORTEX, Cortex-M3 and THUMB are trademarks or registered trademarks of ARM Holdings. Keil is a registered trademark of ARM Limited. All other products or brand names mentioned herein are trademarks of their respective holders.



**SILICON LABS**

Silicon Laboratories Inc.  
400 West Cesar Chavez  
Austin, TX 78701  
USA

<http://www.silabs.com>