

1A, 200V - 600V Surface Mount Ultrafast Rectifiers

FEATURES

- Very low profile - typical height of 0.68mm
- Reduce switching and conduction loss
- Ideal for automated placement
- Ultrafast recovery times for high frequency
- Compliant to RoHS Directive 2011/65/EU and in accordance to WEEE 2002/96/EC
- Halogen-free according to IEC 61249-2-21



Micro SMA



APPLICATION

ESH1DM to ESH1JM is ideal device for the compact space PCB design.

Specially as boost diode in power factor correction circuitry.

The device is also intended for use as a free wheeling diode in power supplies

For chargers, LED lighting, and other power switching applications.

MECHANICAL DATA

Case: Micro SMA

Molding compound: UL flammability classification rating 94V-0

Moisture sensitivity level: level 1, per J-STD-020

Part no. with suffix "H" means AEC-Q101 qualified

Packing code with suffix "G" means green compound (halogen-free)

Terminal: Matte tin plated leads, solderable per JESD22-B102

Meet JESD 201 class 2 whisker test

Polarity: Indicated by cathode band

Weight: 6mg (approximately)

MAXIMUM RATINGS AND ELECTRICAL CHARACTERISTICS (T _A =25°C unless otherwise noted)					
PARAMETER	SYMBOL	ESH1DM	ESH1GM	ESH1JM	UNIT
Marking code		D3	D5	D7	
Maximum repetitive peak reverse voltage	V _{RRM}	200	400	600	V
Maximum average forward rectified current	I _{F(AV)}	1			A
Peak forward surge current, 8.3 ms single half sine-wave superimposed on rated load	I _{FSM}	15			A
Maximum instantaneous forward voltage (Note 1) @ 1 A	V _F	TYP		MAX	V
		1.25		1.5	
Maximum reverse current @ rated VR T _J =25 °C T _J =125 °C	I _R	TYP		MAX	μA
		-		1	
		5		50	
Maximum reverse recovery time (Note 2)	t _{rr}	25			ns
Typical junction capacitance (Note 3)	C _J	3			pF
Typical thermal resistance (Note 4)	R _{θJM}	40			°C/W
	R _{θJA}	92			
Operating junction temperature range	T _J	-55 to +150			°C
Storage temperature range	T _{STG}	-55 to +150			°C

Note 1: Pulse test with PW=300μs, 1% duty cycle

Note 2: Test conditions: I_F=0.5A, I_R=1.0A, I_{RR}=0.25A

Note 3: Measured at 1 MHz and applied reverse voltage of 4.0 V

Note 4: Thermal resistance R_{θJA} - from junction to ambient, R_{θJM} - and junction to mount

ORDERING INFORMATION					
PART NO.	PART NO. SUFFIX	PACKING CODE	PACKING CODE SUFFIX	PACKAGE	PACKING
ESH1xM (Note 1, 2)	H	RS	G	Micro SMA	3,000 / 7" Plastic reel

Note 1: "x" defines voltage from 200V (ESH1DM) to 600V (ESH1JM)

Note 2: Whole series with green compound

EXAMPLE					
EXAMPLE P/N	PART NO.	PART NO. SUFFIX	PACKING CODE	PACKING CODE SUFFIX	DESCRIPTION
ESH1JMHRSG	ESH1JM	H	RS	G	Automotive grade Green compound

RATINGS AND CHARACTERISTICS CURVES

(T_A=25°C unless otherwise noted)

FIG.1 MAXIMUM FORWARD CURRENT DERATING CURVE

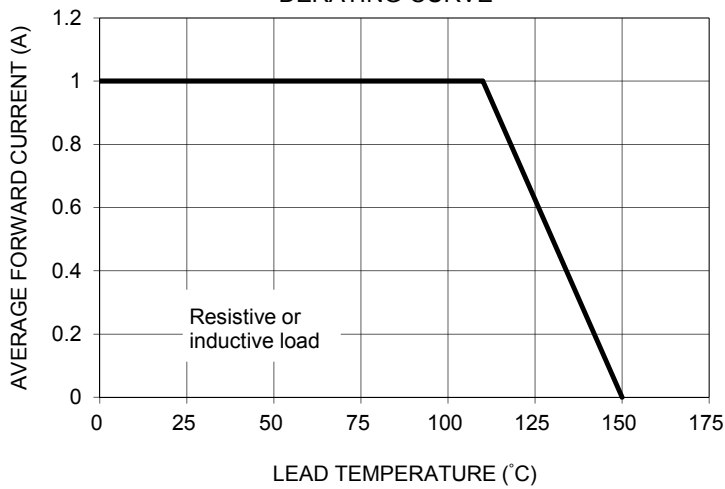

FIG. 2 MAXIMUM FORWARD SURGE CURRENT

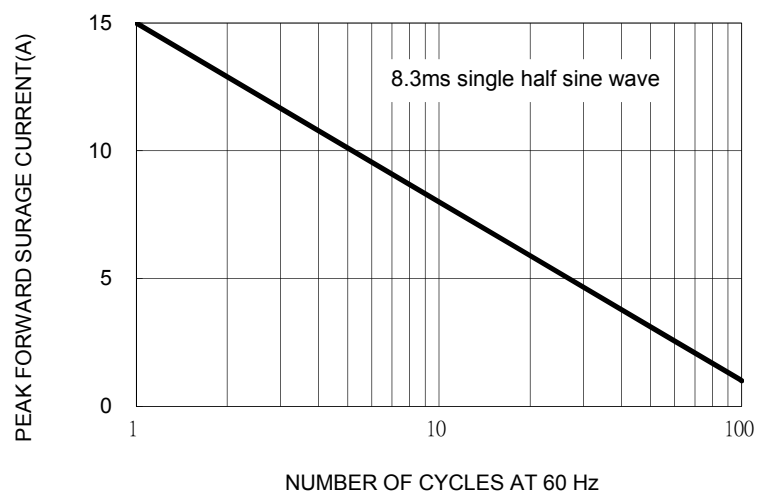

FIG. 3 TYPICAL FORWARD CHARACTERISTICS

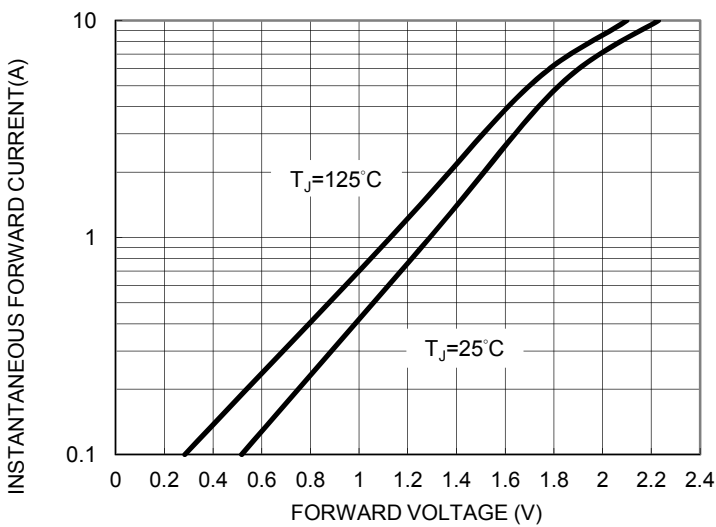
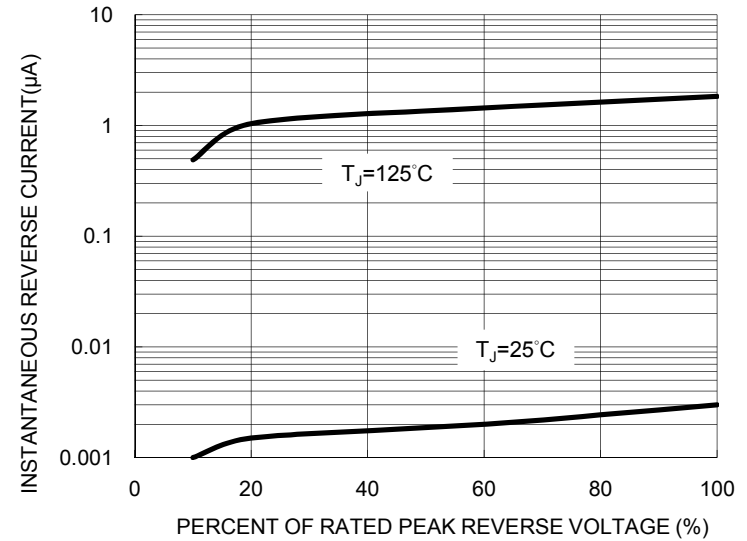
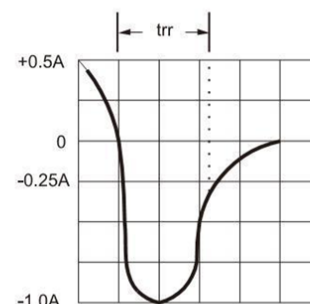
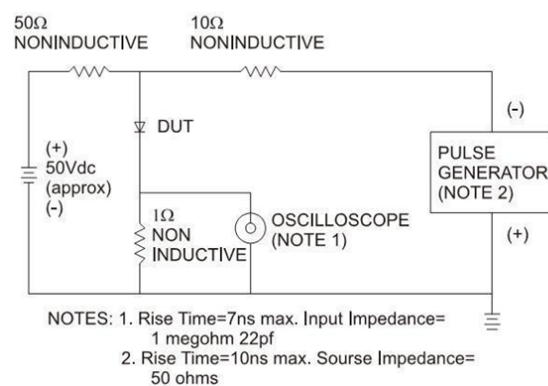

FIG. 4 TYPICAL REVERSE CHARACTERISTICS



REVERSE RECOVERY TIME CHARACTERISTIC AND TEST CIRCUIT DIAGRAM



PACKAGE OUTLINE DIMENSIONS

Micro SMA

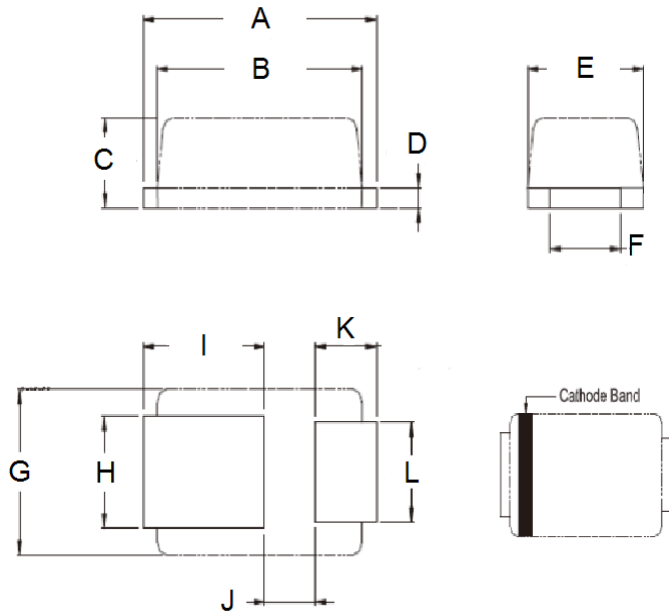

DIM.	Unit (mm)		Unit (inch)	
	Min	Max	Min	Max
A	2.30	2.70	0.091	0.106
B	2.10	2.30	0.083	0.091
C	0.63	0.73	0.025	0.029
D	0.10	0.20	0.004	0.008
E	1.15	1.35	0.045	0.053
F	0.65	0.85	0.026	0.034
G	1.15	1.35	0.045	0.053
H	0.75	0.95	0.030	0.037
I	1.10	1.50	0.043	0.059
J	0.55	0.75	0.022	0.030
K	0.55	0.75	0.022	0.030
L	0.65	0.85	0.026	0.034

SUGGESTED PAD LAYOUT

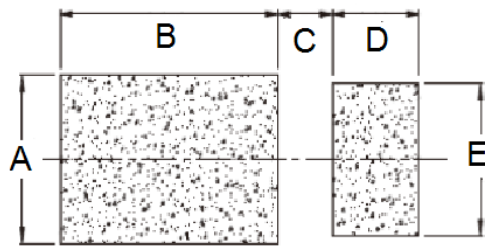

Symbol	Unit (mm)	Unit (inch)
A	1.1	0.043
B	2.0	0.079
C	0.5	0.020
D	0.8	0.031
E	1.0	0.039

MARKING DIAGRAM



P/N = Marking code
YW = Date Code

Notice

Specifications of the products displayed herein are subject to change without notice. TSC or anyone on its behalf, assumes no responsibility or liability for any errors or inaccuracies.

Information contained herein is intended to provide a product description only. No license, express or implied, to any intellectual property rights is granted by this document. Except as provided in TSC's terms and conditions of sale for such products, TSC assumes no liability whatsoever, and disclaims any express or implied warranty, relating to sale and/or use of TSC products including liability or warranties relating to fitness for a particular purpose, merchantability, or infringement of any patent, copyright, or other intellectual property right.

The products shown herein are not designed for use in medical, life-saving, or life-sustaining applications. Customers using or selling these products for use in such applications do so at their own risk and agree to fully indemnify TSC for any damages resulting from such improper use or sale.