

3M™ EM Aware TNG ESD Event Monitor

Models 3M034-3-TNG, 3M034-030-TNG
and 3M034-031-TNG, Including Starter Kits

User's Guide



Table of Contents

Section	Page
Intended Use	3
Safety Statements.....	4
Package Contents	5
Installation and Mounting Instructions	5
Controlling the Monitor	7
Changing the ESD Event Parameters.....	8
Data Acquisition System.....	10
Regulatory Information.....	11
Warranty.....	14

Read, understand and follow all safety information contained in these user guide instructions prior to installation of the 3M™ EM Aware TNG ESD Event Monitor. Retain these instructions for future reference.

INTENDED USE

The EM Aware TNG ESD Event Monitor monitors up to three key parameters that keep you aware of critical symptoms of ESD problems: 1) ESD events*; 2) change in static voltage; 3) verify ionizer**. The thresholds for these parameters are fully adjustable to suit your needs. The improved design features a metal case module with built-in LCD display, a control joystick, remote antenna, power supply and a data output.

The monitor system must be installed as specified in this user's guide. It is intended for use in the following environmental conditions only:

1. Indoor use
2. Altitudes up to 2,000 meters above sea level
3. Temperature range of 10°C to 40°C
4. Maximum relative humidity of 80% for temperatures up to 31°C, decreasing linearly to 50% relative humidity at 40°C
5. Pollution degree two (office, laboratory, test station)

The monitor system has not been evaluated for other uses or locations. If the monitor is used in a manner not specified by 3M, the protection provided by the equipment may be impaired.

**Not all ESD events are captured by the EM Aware TNG ESD Event Monitor. The magnitude of the event can be measured. CDM, HBM and MM Model results are estimated based on proprietary algorithms.*

*** Function is designed to work ONLY with critical environment ionizers having an offset balance of less than +/- 5 volts.*

Safety Information

Explanation of Signal Word Consequences



WARNING Indicates a potentially hazardous situation, which, if not avoided, could result in death or serious injury and/or property damage.



CAUTION Indicates a potentially hazardous situation which, if not avoided, could result in minor or moderate injury and/or property damage.

NOTICE Indicates a potentially hazardous situation, which, if not avoided, may result in property damage.

Explanation of Product Safety Label Symbols



Earth Ground



Indicates DC (Direct Current)



Important safety information, refer to the user's guide.



WARNING

To reduce the risks associated with hazardous voltage, which if not avoided, could result in death or serious injury:

- Do not modify or disassemble this product;
- Never allow children or other non-qualified persons to come into contact with power adapter;
- Never use power adapter outdoors or other wet locations;
- Always use extreme caution to avoid coming into contact with any exposed electrical conductors of the equipment being monitored with the EM Aware TNG ESD Event Monitor.

To reduce the risks associated with hazardous voltage or possible explosion, which if not avoided, could result in death or serious injury,

- Use only the power adapter provided with the product;
- If power adapter is missing or damaged, only replace with one supplied by 3M.



CAUTION

To reduce the risks associated with ground water contamination:

- Never incinerate or dispose of product in a manner which is inconsistent with local, state, or federal regulations.

NOTICE

To reduce the risks associated with Electrostatic Discharge (ESD) voltage, which if not avoided, could result in damage to the meter:

- To install or change antennas, turn off the meter, install or change antennas, turn meter back on;
- Avoid touching antenna when meter is turned on.

FAILURE TO FOLLOW THESE INSTRUCTIONS MAY RESULT IN IRREVERSIBLE DAMAGE TO EM AWARE TNG AND HARM TO PERSONNEL AND EQUIPMENT:

- If the 3M™ EM Aware TNG ESD Event Monitor is connected to a facility monitoring system (FMS), always verify that there is zero voltage and low resistance between FMS ground and ground at the location where EM Aware TNG ESD Event Monitor is installed and is being grounded. If ground conditions are unacceptable, correct them first prior to installing the EM Aware TNG ESD Event Monitor. Otherwise, damage to the EM Aware TNG ESD Event Monitor and/or to the FMS may occur.

Package Contents

Check that the following items are included with the 3M™ EM Aware TNG ES Event Monitor Starter Kit shipping package:

- EM Aware TNG module
- Remote antenna with cable
- Power adapter
- Data Acquisition System (Data box, installation CD, and USB cable)
- Multi-port cable
- Grounding terminal with screw and washer
- Container with metal screws (for testing functionality of the monitor)

Installation and Mounting Instructions (Optional)

The EM Aware TNG ESD Event Monitor Model 3M034 can be mounted horizontally or vertically. For semi-permanent positioning, two #4-40 screws or an equivalent may be used. For such an installation, mark the surface where the holes should be drilled and drill pilot holes using a #44 tap drill size.

Connect the 3M™ EM Aware TNG ESD Event Monitor

Connect the EM Aware TNG ESD Event Monitor shown in Figure 1.

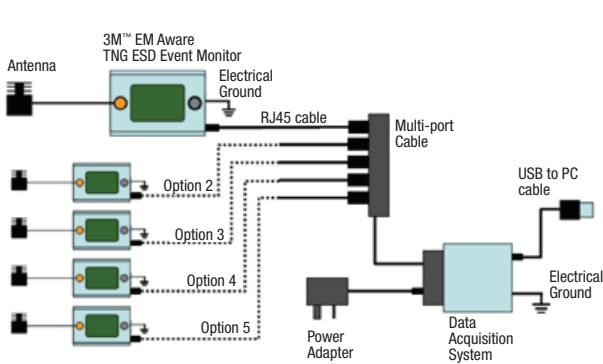

Figure 1

Alternatively, the EM Aware TNG ESD Event Monitor can be connected as a standalone system. Follow the connection shown in Figure 2.

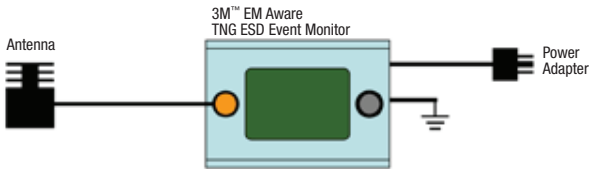

Figure 2

Without connecting the USB plug into the PC, test the 3M™ EM Aware TNG ESD Event Monitor by plugging the power adaptor into the main power supply. The power adaptor is a +12V DC supply with a 2.1 mm barrel connector, center positive. The EM Aware TNG ESD Event Monitor will light up with the display. Shake the container above the antenna and the EM Aware TNG ESD Event Monitor should respond with beeps. In an installation where power supply provides power to more than just EM Aware TNG monitors, it is recommended to consider a separate power supply just for the network of EM Aware TNG units.

Setting up the the Data Acquisition System

(See procedures in the Data Acquisition System section)

Controlling the EM Aware TNG ESD Event Monitor

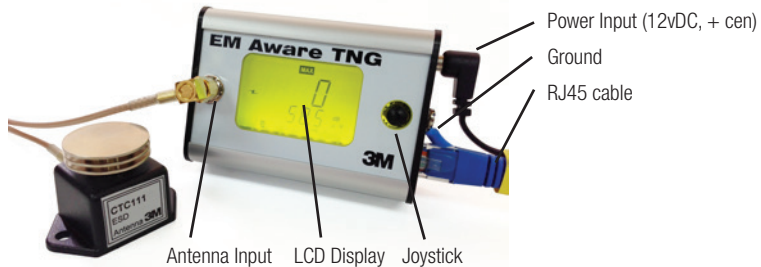

The EM Aware TNG ESD Event Monitor is controlled using a 5-way joystick on the right side of the screen; 1) Left, 2) Right 3) Up, 4) Down, and 5) Push. They will be referred as L, R, U, D and P in this user's guide. The first level control takes place upon power up, in which case all L, R, U, D, controls do the same function. All of the directions scroll through the parameter displays as shown in Figure 3.

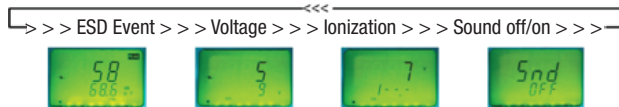
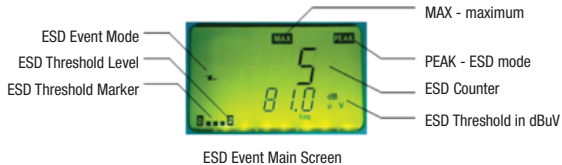

Figure 3

At any of the parameters displayed, the push of the joystick brings the next level control, which allows you to change the parameter settings, i.e. thresholds.

Changing the ESD Event Parameters

1. To reset the ESD counter to zero, press the joystick momentarily.
2. To change the ESD threshold, press the joystick longer until “ESD” is displayed. Move the joystick left or right to decrease or increase the threshold value. On this screen, a “REF” symbol appears on the top left corner.
3. To disable or enable CDM filter, move the joystick up or down to “on” or “off” CDM filter. A PEAK symbol appears on screen when the ESD filter is active.
4. To finalize the settings, push the joystick longer until the main ESD Event screen appears. A “MEM” symbol appears momentarily in this process.



Change in the Static Voltage - Parameters

1. At the main screen display (no “REF” symbol), move the joystick until the display is as shown above.
2. To reset the over-threshold counter to zero, press the joystick momentarily.
3. To change the voltage range and thresholds, push the joystick longer until a new screen appears. The new screen shows a “REF” symbol at the right top corner.
4. Move the joystick up or down to scroll on the voltage range options.
5. Move the joystick left or right to decrease or increase the static voltage threshold.
6. To finalize the settings, push the joystick longer until the screen shows the main static voltage screen.

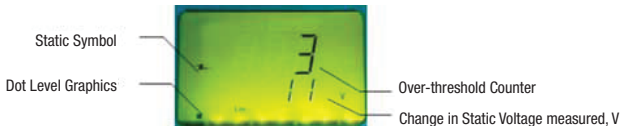

Verification of Ionization - Parameters

1. At the main screen display (no “REF” symbol), move the joystick until the display is as shown similar above.
2. To manually test the discharge time, press the joystick momentarily.
3. The discharge time is also automatically measured every two minutes.
4. To change the voltage range and thresholds, push the joystick longer until a new screen appears. The new screen is as shown below.
5. Move the joystick up or down to increase or decrease the time threshold.



6. Move the joystick left or right to decrease or increase the ionization threshold.
7. To finalize the settings, push the joystick longer until the screen shows the main static voltage screen.

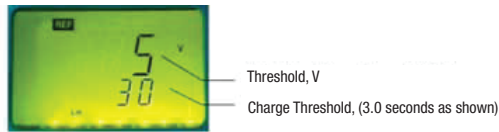

Threshold Status

Application note: Measuring Ionization

Observe the waveform in the third row. Notice that the line is close to the zero level. This would indicate a balanced condition. A line that is above or below the zero level represents the voltage seen. An alarm indication on the 3M™ EM Aware TNG ESD Event Monitor means that the voltage threshold was exceeded.

Application note: Measuring Discharge Time

Time to discharge is measured at intervals of approximately two minutes. Observe the dot level line on the bottom of the display (see previous page). If the time to discharge exceeds the threshold time, an alarm is heard on the EM Aware TNG ESD Event Monitor.

Data Acquisition System

Installing the Data Logging Software

Follow the instructions on the data acquisition CD to install the 3M™ EM Aware TNG ESD Event Monitor software.

Configuring the Software

This EM Aware TNG ESD Event Monitor Starter Kit is for monitoring most ESD events and ionization. The first channel for each RJ45 jack is for ESD events; the second is for change in static voltage; and the third is for ionization verification. Please refer to the table below:

EM Aware Units (Number of Units in a Kit)					
RJ45 Jack Identification	Unit 1	Unit 2	Unit 3	Unit 4	Unit 5
ESD Events Channels	1	4	7	10	13
Change in Static Voltage	2	5	8	11	14
Ionizer Verification Channel	3	6	9	12	15

Smart Co-efficient (SCF)

The Smart Coefficient (SCF) feature works in conjunction with the change in voltage function (Models -030 and -031 only). This feature is useful when a closer approximation of a known instrument's value is desired. Or when the distance is being estimated. Contact 3M for more information on this feature.

Technical assistance contact information:

3M Innovation Singapore PTE LTD
100 Woodlands Avenue 7
Singapore 738205
Phone: (65) 6852 1000

Regulatory Statements

China RoHS

Electronic Industry Standard of the People's Republic of China, SJ/T11363-2006, Requirements for Concentration Limits for Certain Hazardous Substances in Electronic Information Products.



This symbol, per Marking for the Control of Pollution Caused by Electronic Information Products, SJ/T11364-2006, means that the product or part does contain a substance, as detailed in the chart below, in excess of the following maximum concentration values in any homogeneous material: (a) 0.1% (by weight) for lead, mercury, hexavalent chromium, polybrominated biphenyls or polybrominated diphenyl ethers; or (b) 0.01% (by weight) for cadmium. Unless otherwise stated by 3M in writing, this information represents 3M's best knowledge and belief based upon information provided by third party suppliers to 3M.

Name and Content of Hazardous Substances or Elements

Part or Component Name	Hazardous Substances or Elements					
	(Pb)	(Hg)	(Cd)	(Cr (VI))	(PBB)	(PBDE)
Termination in capacitor 0603	X	O	O	O	O	O
Solder in diode	X	O	O	O	O	O
Finish in diode	X	O	O	O	O	O
Terminations in PCBs	X	O	O	O	O	O
Terminations in resistors 0603	X	O	O	O	O	O
Plating in resistors 0603	X	O	O	O	O	O
Resistor ink in potentiometer	X	O	O	O	O	O
Solder in instrument	X	O	O	O	O	O
Solder in IC	X	O	O	O	O	O
Solder in buzzer	X	O	O	O	O	O
Audio jack	X	O	O	O	O	O

O: Indicates that this hazardous substance contained in all of the homogeneous materials for this part is below the limit requirement in the SJ/T11363-2006.

X: Indicates that this hazardous substance contained in at least one of the homogeneous materials used for this part is above the limit requirement in the SJ/T11363-2006.

产品中有毒有害物质或元素的名称及含量

部件名称	有毒有害物质或元素					
	铅	汞	镉	六价铬	多溴联苯	多溴二苯醚
0603电容引脚	X	○	○	○	○	○
二极管焊接部	X	○	○	○	○	○
二极管电镀	X	○	○	○	○	○
印刷电路板焊盘/安装孔	X	○	○	○	○	○
0603 电阻引脚	X	○	○	○	○	○
0603 电阻电镀部	X	○	○	○	○	○
电位器中的电阻油墨	X	○	○	○	○	○
装置的焊接部	X	○	○	○	○	○
IC焊接部	X	○	○	○	○	○
蜂鸣器焊接部	X	○	○	○	○	○
音频插孔	X	○	○	○	○	○

○: 表示该有毒有害物质在该部件所有均质材料中的含量均在SJ/T11363-2006 标准规定的限量要求以下。
 X: 表示该有毒有害物质至少在该部件的某一均质材料中的含量超出SJ/T11363-2006 标准规定的限量要求。

FCC

NOTE: This equipment has been tested and found to comply with the limits for a Class A digital device, pursuant to Part 15 of the FCC Rules. These limits are designed to provide a reasonable protection against harmful interference when the equipment is operated in a commercial environment. This equipment generates, uses, and can radiate radio frequency energy and, if not installed and used in accordance with the instruction manual, may cause harmful interference to radio communications. Operation of this equipment in a residential area is likely to cause harmful interference in which case the user will be required to correct the interference at their own expense.

NOTE: Modifications to this device shall not be made without the written consent of 3M. Unauthorized modifications may void the authority granted under Federal Communication Rules and Industry Canada Rules permitting the operation of this device.

This device complies with Part 15 of the FCC Rules. Operation is subject to the following two conditions: (1) this device may not cause harmful interference, and (2) this device must accept any interference received, including interference that may cause undesired operation.

CE Statement

Meets CE (European Conformity) requirements.

ICES Statement

This Class A digital apparatus complies with Canadian ICES-003.

Cet appareil numérique de la classe A est conforme à la NMB-003 du Canada.

cULus Statement

Meets cULus requirements.

WEEE Statement

The following information is only for EU-members States: The mark shown to the right is in compliance with Waste Electrical and Electronic Equipment Directive 2002/96/EC (WEEE). The mark indicates the requirement NOT to dispose the equipment as unsorted municipal waste, but use the return and collection systems according to local law.

3M and EM Aware are trademarks of 3M Company.

Important Notice

All statements, technical information, and recommendations related to 3M's products are based on information believed to be reliable, but the accuracy or completeness is not guaranteed. Before using this product, you must evaluate it and determine if it is suitable for your intended application. You assume all risks and liability associated with such use. Any statements related to the product which are not contained in 3M's current publications, or any contrary statements contained on your purchase order shall have no force or effect unless expressly agreed upon, in writing, by an authorized officer of 3M.

Warranty; Limited Remedy; Limited Liability.

This product will be free from defects in material and manufacture for one year from the time of purchase. **3M MAKES NO OTHER WARRANTIES INCLUDING, BUT NOT LIMITED TO, ANY IMPLIED WARRANTY OF MERCHANTABILITY OR FITNESS FOR A PARTICULAR PURPOSE.** If this product is defective within the warranty period stated above, your exclusive remedy shall be, at 3M's option, to replace or repair the 3M product or refund the purchase price of the 3M product. **Except where prohibited by law, 3M will not be liable for any indirect, special, incidental or consequential loss or damage arising from this 3M product, regardless of the legal theory asserted.**

3M

Electronics Materials Solutions Division Static Control Products

926 JR Industrial Drive
Sanford, NC 27332-9738
Toll-Free: 866-722-3736
International: 919-718-0000
Email: 3mstaticinfo@mmm.com
www.3Mstatic.com



Please recycle. Printed in USA.
© 3M 2014. All rights reserved.
78-9101-0767-7 JHA