

THESE DRAWINGS ARE THE PROPERTY OF QUALTEK ELECTRONICS AND NOT TO BE REPRODUCED FOR OR COMMUNICATED TO A THIRD PARTY WITHOUT THE EXPRESS WRITTEN PERMISSION OF AN OFFICER OF QUALTEK ELECTRONICS.

REVISION			
REV.	DESCRIPTION	DATE	APPROVED
B	RoHS Compliancy	06-01-06	DP
C	Updated Approvals	03-16-15	LY

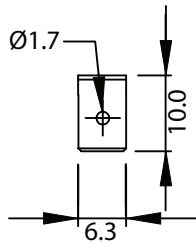
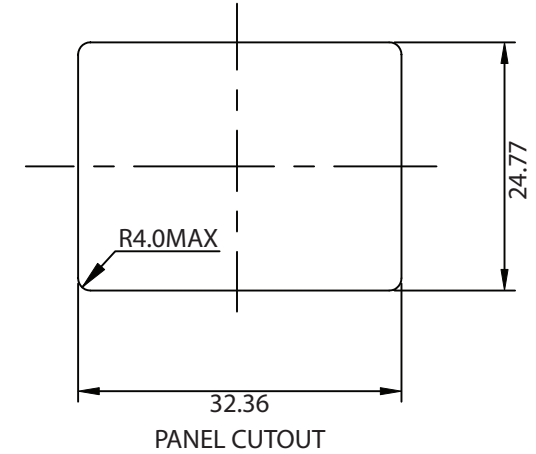
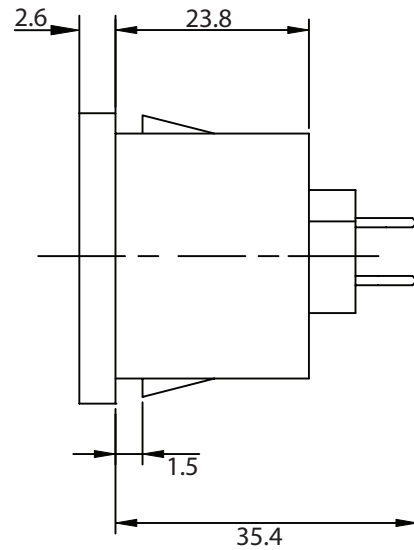
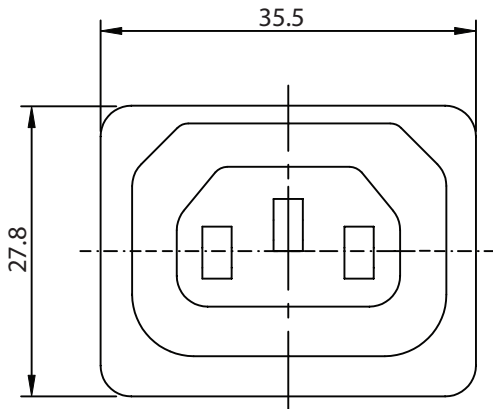

NOTES:

RATING:

UL,CSA: 15A 250V AC

APPROVALS: UL,CSA

PANEL THICKNESS: 1.5mm

RoHS COMPLIANT

CONTROLLED

Dim range (mm)	Tolerance +/- (mm)	Qualtek Electronics Corp. PPC DIVISION		
		Part Number:	716-15/63	RoHS Compliant
0-1	0.15	Description: AC RECEPTACLE		
1-6	0.20		UNIT: mm	REV. C
6-18	0.30			
18-50	0.50			
50-120	0.70	Drawn / Date	Checked / Date	Approved / Date
120-250	0.90	B.Zhang 07-01-02	07-01-02	JJH / 07-01-02
250-500	1.20			