

Application: (Intel Core i7-Per) Picture:

Extreme edition sequence
Intel LGA1366 Bloomfield(45nm) CPU
Core i7 940/920/950

Thermal & Mechanical Spec.:

Thermal performance for 130W CPU
HSK Assembly Weight: 540 g (ref.)
Clipping Force: 16 Kgf (ref.)

Component Specification:

1. Heat Sink
Type: Thermal Shrink with Cu core
Material: Aluminum A6063 & Cu C1100 or Equivalent.
Dimension: 100*100*40 mm
2. Thermal interface material
Material: Dow-Corning TC-5630 or Equivalent 
3. Fan *(90x20mm with Thermistor & PWM Control)*
Rated Voltage: 12 V
Life Time:
Superflo bearing 50000 hrs
Connector:
 - a. Lead wire: UL 1430 AWG#26
pin 1: black wire-----(-)
pin 2: yellow wire-----(+)
pin 3: green wire----- (F00)
pin 4: blue wire----- (PWM)
 - b. Housing: Molex 47054-1000 or equivalent
 - c. Terminal: Molex 2759T 08-50-0113 or equivalent



* All readings are typical values at rated voltage.
* Specifications are subject to change without notice





APPROVAL SHEET

Customer Name .:

Model Name.: _____
COOLER

Delta Part No.: _____
FHS-A9020S01

Customer Part No.:

Spec Issue Date .: _____
12/28/2015

Spec Revision : _____
01

PLEASE SEND ONE COPY OF THIS SPECIFICATION BACK AFTER YOU
SIGNED APPROVAL FOR PRODUCTION PRE-ARRANGMENT.

Approved By: _____

Date: _____

Approval	Check	Designer
Alex-Hsia	Alex-Hsia	Charles Chen



Delta Electronics Corp.

REV.	Description	Drawn	Checked	Approved	Issue Date
00	ISSUE SPEC	REEK.LI 11/3'09	Charles Chen 11/3'09	Alex-Hsia 11/3'09	
01	CHANGE TIM FROM TC-1996 TO TC-5630	Charles Chen 12/28'15	Alex-Hsia 12/28'15	Alex-Hsia 12/28'15	
Description: SAMPLE REVISION CODE LIST					
Part No.					REV
DELTA MODEL : FHS-A9020S01			TOTAL 25 PAGE		01



Delta Electronics Corp.

CONTENTS

Item	Element Description	Page	Note
1	Specification	5	
2	Print	6	
3	Packing Plan	11	
4	Fan	14	



Delta Electronics Corp.

1. SPECIFICATION

Characters

Item	Description
Scope	THIS SPECIFICATION DEFINES THE ELECTRICAL AND MECHANICAL CHARACTERISTICS OF THE FAN HEATSINK
Application	INTEL CPU COOLER
Specification	
a: Thermal Resistance	0.25 (°C/W) (REF.)
b: total weight	540 g (REF.)
c: clip force	16 kgf (REF.)

BOM

Item	Part Name	Material	Part NO.	Q'TY	Remark
1	FAN	PBT	3622918011	1	
2	HEATSINK	AL6063-T5 & Cu1100	3345115400	1	
3	FASTENER CAP	PC	3470089500	4	
4	FASTENER BASE	PC	3470415500	4	
5	LABEL	PE	3266708400	1	
6	TIM	DOW TC-5630	4021107300	0.1125g	Rev 01



Delta Electronics Corp.

2. PRINT

Assembly Drawing

Parts Drawing

DRAWING:

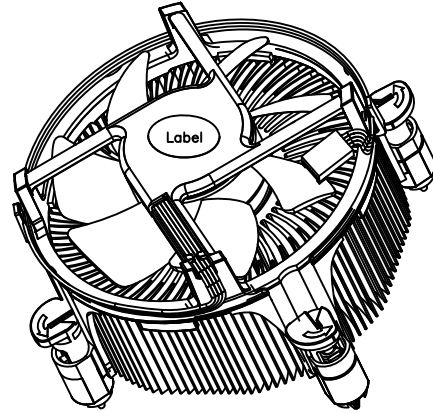
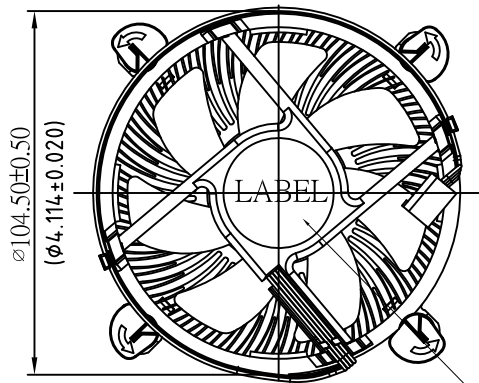

FAN LABEL P/N:3266708400

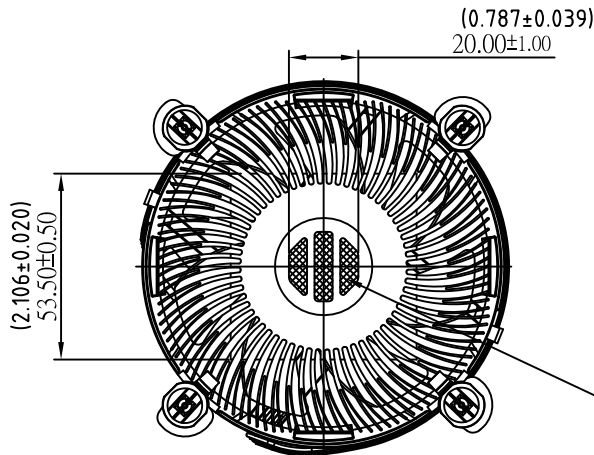
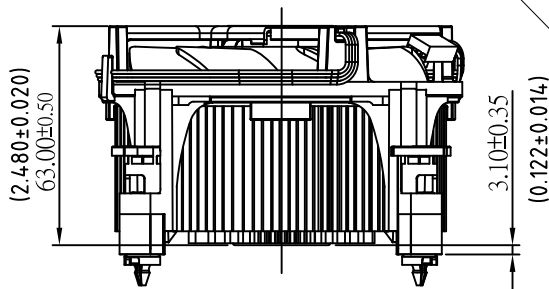

Dow Corning TC-5630 P/N:4021107300
 STENCIL THICKNESS=0.20MM(MIN.),0.22MM(MAX.)
 TIM WEIGHT ON HSK MUST BE 112.5mg+/-30mg

UNIT: $\frac{\text{mm}}{\text{(INCH)}}$

 台達電子工業股份有限公司 DELTA ELECTRONICS, INC.	DELTA MODEL: FHS-A9020S01	Drawn: Charles Chen 12/28'15
	CUSTOMER NAME: ----- CUSTOMER P/N: -----	
THESE DRAWINGS AND SPECIFICATIONS ARE THE PROPERTY OF DELTA ELECTRONICS, INC. AND SHALL NOT BE REPRODUCED OR USED AS THE BASIS FOR THE MANUFACTURE OR SELL OF APPARATUSES OR DEVICES WITHOUT PERMISSION.	Description: PRODUCTION SPEC. (PHYSICAL DIMENSION)	
DIMENSIONAL TOLERANCES () () () HOLES : ±0.05 ANGLES : ±0.5° <30 :±0.25 DECIMALS UP~100 :±0.2 250~300 :±0.4 UP~600 :±1.5 >30~100 :±0.35 X :±0.3 100~150 :±0.25 300~350 :±0.45 600~900 :±2.4 >100~300 :±0.5 X.X :±0.2 150~200 :±0.3 350~400 :±0.5 900~OVER :±3.1 ABOVE 300 :±0.6 X.XX :±0.1 200~250 :±0.35	Part No. FHS-A9020S01-PD	REV. ---
SCALE --- UNIT mm USED ON COOLER	A4 SIZE SHEET 1 OF 2	ISSUE DATE:



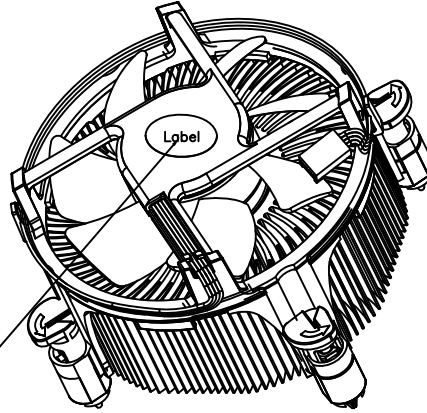

DATECODE POSITION
TYPE: WHITE INK





DATECODE POSITION

NOTE:

1. DATECODE ON FAN LABEL.
2. PLEASE REFER TO CP10S-00345 WHILE PRINTING DATECODE.

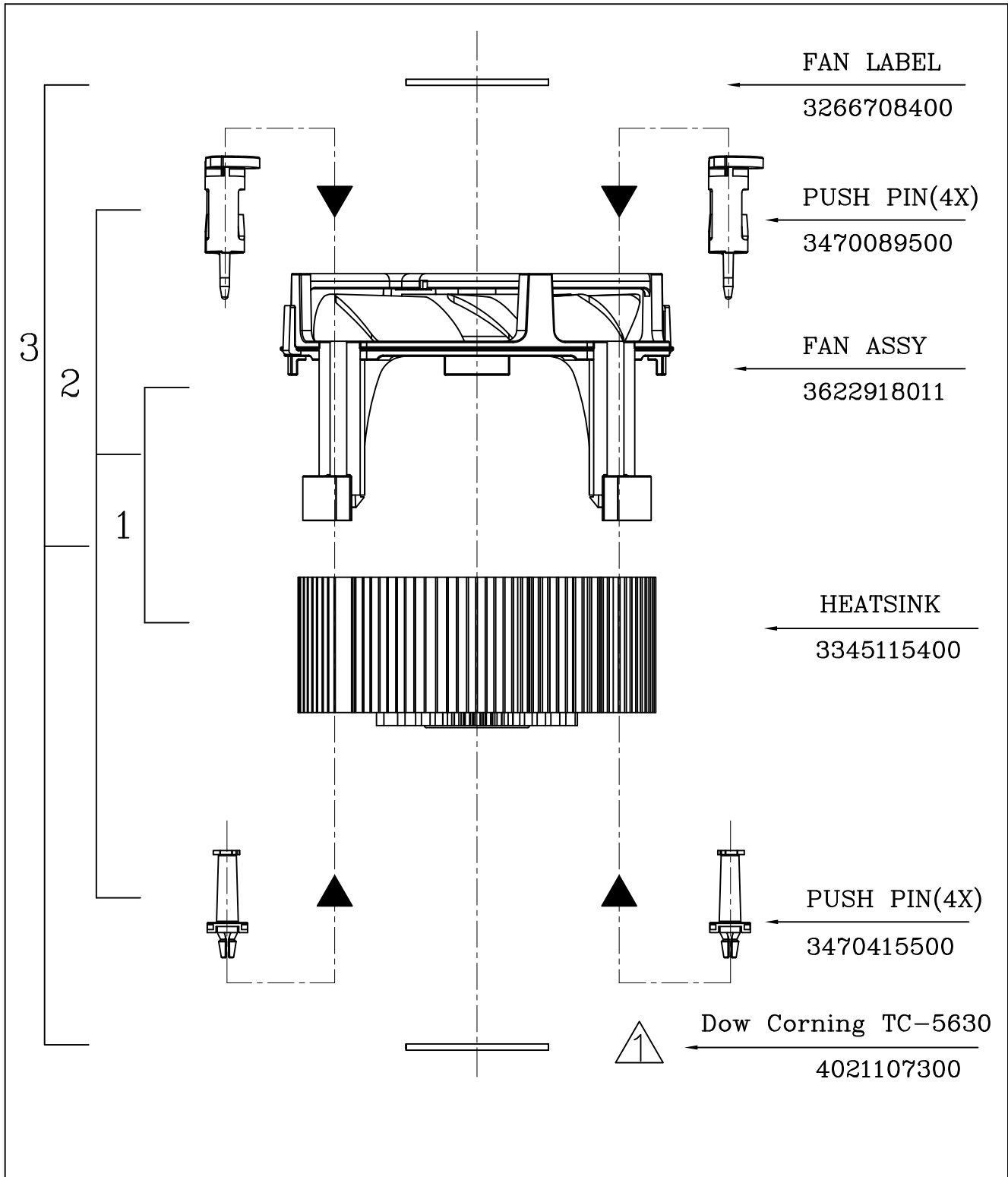
 台達電子工業股份有限公司 DELTA ELECTRONICS, INC.	DELTA MODEL: FHS-A9020S01		Drawn: Charles Chen 12/28'15	
	THESE DRAWINGS AND SPECIFICATIONS ARE THE PROPERTY OF DELTA ELECTRONICS, INC. AND SHALL NOT BE REPRODUCED OR USED AS THE BASIS FOR THE MANUFACTURE OR SELL OF APPARATUSES OR DEVICES WITHOUT PERMISSION.			
CUSTOMER NAME: -----		CUSTOMER P/N: -----		
DESCRIPTION: PRODUCTION SPEC. (PHYSICAL DIMENSION)				
DIMENSIONAL TOLERANCES () () () HOLES : ±0.05 ANGLES : ±0.5° () () () () <30 :±0.25 DECIMALS UP~100 :±0.2 250~300 :±0.4 UP~600 :±1.5 >30~100 :±0.35 X :±0.3 100~150 :±0.25 300~350 :±0.45 600~900 :±2.4 >100~300 :±0.5 XX :±0.2 150~200 :±0.3 350~400 :±0.5 900~OVER :±3.1 ABOVE 300 :±0.6 XXX :±0.1 200~250 :±0.35		Part No. FHS-A9020S01-PD		REV. ---
SCALE ---	UNIT mm	USED ON	COOLER	A4 SIZE
SHEET 2 OF 2		ISSUE DATE:		---



 台達電子工業股份有限公司 DELTA ELECTRONICS, INC.	DELTA MODEL: FHS-A9020S01	Drawn: Charles Chen 12/28'15
	CUSTOMER NAME: -----	CUSTOMER P/N: -----
THESE DRAWINGS AND SPECIFICATIONS ARE THE PROPERTY OF DELTA ELECTRONICS, INC. AND SHALL NOT BE REPRODUCED OR USED AS THE BASIS FOR THE MANUFACTURE OR SELL OF APPARATUSES OR DEVICES WITHOUT PERMISSION.	Description: PRODUCTION SPEC. (ASSEMBLY ORDER)	REV. ---
DIMENSIONAL TOLERANCES () () () HOLES : ±0.05 ANGLES : ±0.5° <30 :±0.25 DECIMALS UP~100 :±0.2 250~300 :±0.4 UP~600 :±1.5 >30~100 :±0.35 X :±0.3 100~150 :±0.25 300~350 :±0.45 600~900 :±2.4 >100~300 :±0.5 XX :±0.2 150~200 :±0.3 350~400 :±0.5 900~OVER :±3.1 ABOVE 300 :±0.6 XXX :±0.1 200~250 :±0.35	 A4 SIZE	Part No. FHS-A9020S01 SHEET 1 OF 1 ISSUE DATE:
SCALE --- UNIT mm USED ON COOLER		

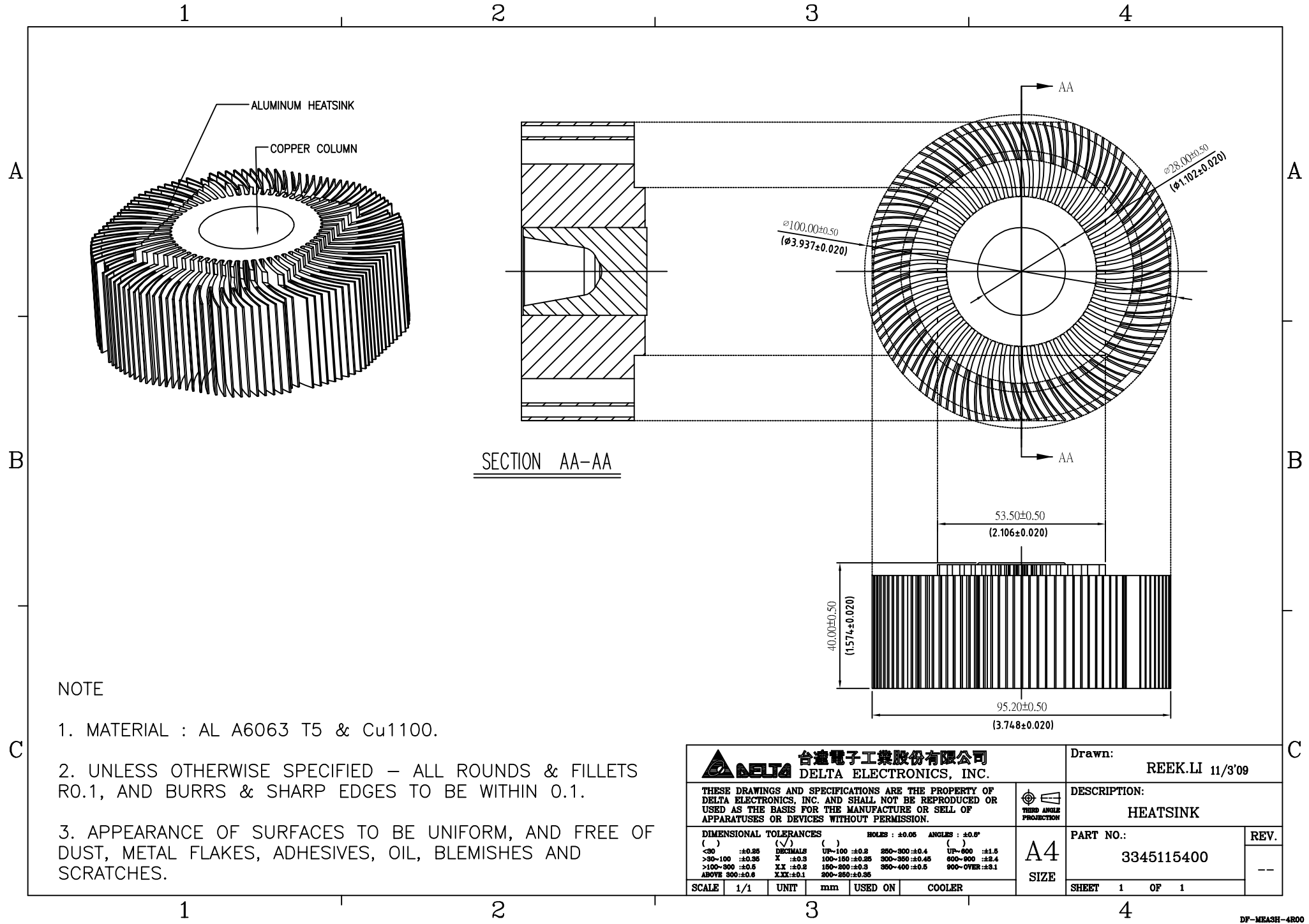

NOTE

1. MATERIAL : AL A6063 T5 & Cu1100.
2. UNLESS OTHERWISE SPECIFIED – ALL ROUNDS & FILLETS R0.1, AND BURRS & SHARP EDGES TO BE WITHIN 0.1.
3. APPEARANCE OF SURFACES TO BE UNIFORM, AND FREE OF DUST, METAL FLAKES, ADHESIVES, OIL, BLEMISHES AND SCRATCHES.

台達電子工業股份有限公司 DELTA ELECTRONICS, INC.		Drawn: REEK.LI 11/3'09	
THESE DRAWINGS AND SPECIFICATIONS ARE THE PROPERTY OF DELTA ELECTRONICS, INC. AND SHALL NOT BE REPRODUCED OR USED AS THE BASIS FOR THE MANUFACTURE OR SELL OF APPARATUS OR DEVICES WITHOUT PERMISSION.		DESCRIPTION: HEATSINK	
DIMENSIONAL TOLERANCES () :±0.25 () :±0.35 () :±0.5 () :±0.6 () :±0.1		HOLES : ±0.05 ANGLES : ±0.0° UP-100 :±0.2 100-150 :±0.25 150-200 :±0.3 200-250 :±0.35 250-300 :±0.4 300-350 :±0.45 350-400 :±0.5 400-500 :±0.5 500-600 :±0.6 600-900 :±0.4 900-OVER :±0.1	
SCALE 1/1 UNIT mm USED ON COOLER		PART NO.: 3345115400 SHEET 1 OF 1 REV. --	

1

2

3

4

A

A

B



B

C

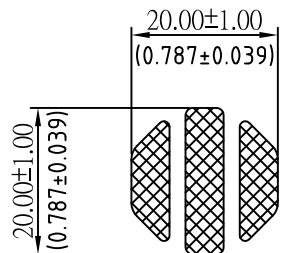
C



- NOTES:
1. THICKNESS: 0.20mm
 2. VENDOR P/N: DOW CORNING TC-5630
 3. COLOR: GRAY.
 4. THERMAL CONDUCTIVITY: 4.5 W/m-°C
 5. THERMAL CONTACT RESISTANCE: 0.06 °C-cm²/W @40psi
 6. GROSS WEIGHT: 112.5±30 mg
 7. VENDOR : DOW CORNING
 8. MUST MEET DELTA'S SPEC : 10000-0162

 台達電子工業股份有限公司 DELTA ELECTRONICS, INC.		Drawn: Charles Chen 12/28'15	
THESE DRAWINGS AND SPECIFICATIONS ARE THE PROPERTY OF DELTA ELECTRONICS, INC. AND SHALL NOT BE REPRODUCED OR USED AS THE BASIS FOR THE MANUFACTURE OR SELL OF APPARATUS OR DEVICES WITHOUT PERMISSION.		 DESCRIPTION: THERMAL INTERFACE	
DIMENSIONAL TOLERANCES () : ±0.25 (✓) : ±0.5 () : ±0.25 () : ±0.5 <30 : ±0.25 DECIMALS UP-100 : ±0.2 250-300 : ±0.4 UP-600 : ±1.5 >30-100 : ±0.25 X : ±0.5 100-150 : ±0.25 300-350 : ±0.45 600-900 : ±2.4 >100-300 : ±0.5 XX : ±0.2 150-200 : ±0.3 350-400 : ±0.5 900-OVER : ±3.1 ABOVE 300 : ±0.6 XXX : ±0.1 300-250 : ±0.35		PART NO.: 4021107300	
SCALE 1/1 UNIT mm USED ON COOLER		REV. -- SHEET 1 OF 1	

1

2

3

4



Delta Electronics Corp.

3. PACKING PLAN

Packing Specification

CARTON ILLUSTRATE	SIZE	475(L)*360(w)*205(H)(mm)	PACKING QUANTITY	2LAYERS/CARTON
	MATERIAL	3 LAYERS"AB" FLUTE	CARTON WEIGHT	0.62 kg (REF.)

CARTON OUTSIDE ILLUSTRATE

FRONT

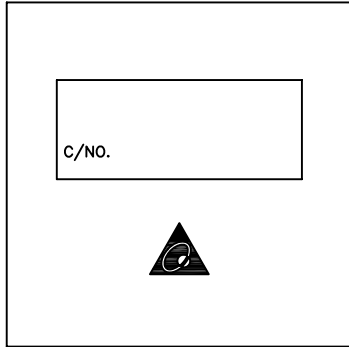

BACK

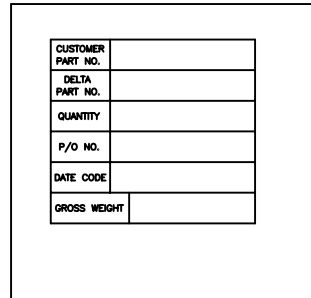

(ONE LABEL PER CARTON)

PET TRAY PACKING ILLUSTRATE	SIZE	112(L)*112(w)*33(H)(mm)	PACKING QUANTITY	1PCS/PET TRAY
	MATERIAL	PET TRAY		
	MATERIAL WEIGHT	6g (REF.)		

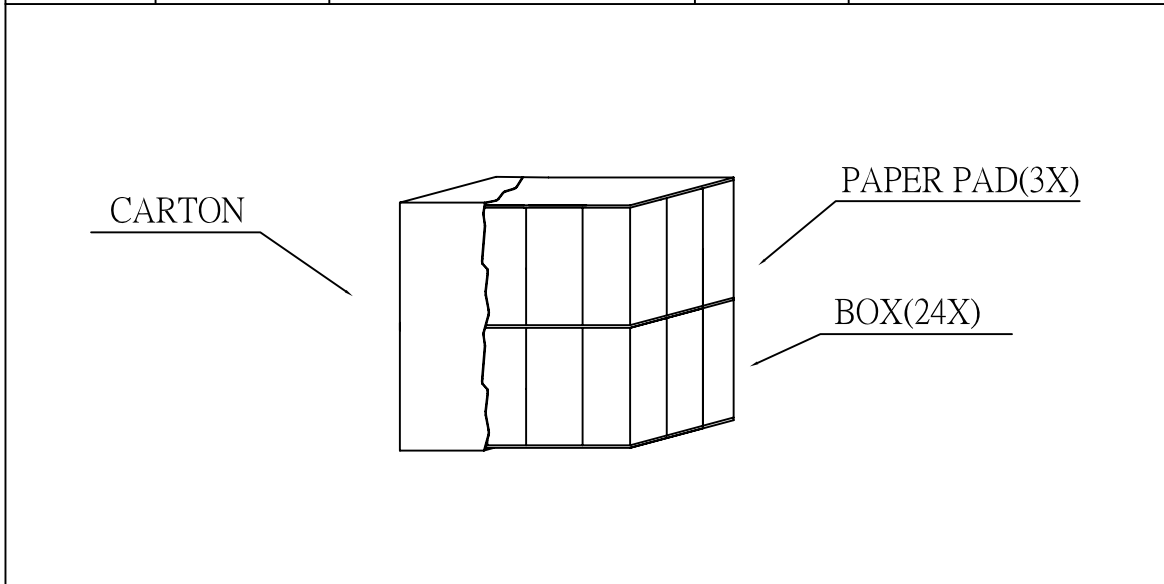

台達電子工業股份有限公司
DELTA ELECTRONICS, INC.

DELTA MODEL:
FHS-A9020S01

Drawn:
REEK.LI

THESE DRAWINGS AND SPECIFICATIONS ARE THE PROPERTY OF DELTA ELECTRONICS, INC. AND SHALL NOT BE REPRODUCED OR USED AS THE BASIS FOR THE MANUFACTURE OR SELL OF APPARATUS OR DEVICES WITHOUT PERMISSION.

CUSTOMER NAME: -----
CUSTOMER P/N: -----

DIMENSIONAL TOLERANCES		HOLES : ±0.05	ANGLES : ±0.5°
()	() ()	()	()
<30 :±0.25	DECIMALS	UP~100 :±0.2	250~300 :±0.4
>30~100 :±0.35	X :±0.3	100~150 :±0.25	300~350 :±0.45
>100~300 :±0.5	XX :±0.2	150~200 :±0.3	350~400 :±0.5
ABOVE 300 :±0.6	XXX :±0.1	200~250 :±0.35	900~OVER :±3.1



Description: PRODUCTION SPEC.
(PACKING ASSMBLY)

A4
SIZE

Part No.
FHS-A9020S01-PA

REV.

SCALE --- UNIT mm USED ON COOLER

SHEET 1 OF 2 ISSUE DATE:

PART NO.	FHS-A9020S01																	
BASIC DATA	QUANTITY/CARTON	24PCS (2 LAYERS/CARTON, 12PCS/LAYER)																
	PRODUCTION NET WEIGHT	13kg (REF.)																
	PRODUCTION GROSS WEIGHT	14.5kg (REF.)																
20(ft)CONTAINER ILLUSTRATE	SIZE	5.889(L)*2.352(w)*2.386(H)m		PACKING QUANTITY														
	CONTAINER	STEEL		20PALLET/CONTAINER														
CONTAINER FORM																		
CONTAINER LOADING MATHOD																		
<table border="1"> <tr> <td>PALLET</td> <td>PALLET</td> <td>PALLET</td> <td>PALLET</td> <td>PALLET</td> </tr> <tr> <td>PALLET</td> <td>PALLET</td> <td>PALLET</td> <td>PALLET</td> <td>PALLET</td> </tr> </table> <p style="text-align: center;">TOP VIEW</p>				PALLET	PALLET	PALLET	PALLET	PALLET	PALLET	PALLET	PALLET	PALLET	PALLET	<table border="1"> <tr> <td>PALLET</td> <td>PALLET</td> </tr> <tr> <td>PALLET</td> <td>PALLET</td> </tr> </table> <p style="text-align: center;">FRONT VIEW</p>	PALLET	PALLET	PALLET	PALLET
PALLET	PALLET	PALLET	PALLET	PALLET														
PALLET	PALLET	PALLET	PALLET	PALLET														
PALLET	PALLET																	
PALLET	PALLET																	

PALLET LOADING ILLUSTRATE	SIZE	117(L)*107(w)*13(H)cm	PACKING QUANTITY	24 CARTONS/PALLET
	PALLET	WOOD		

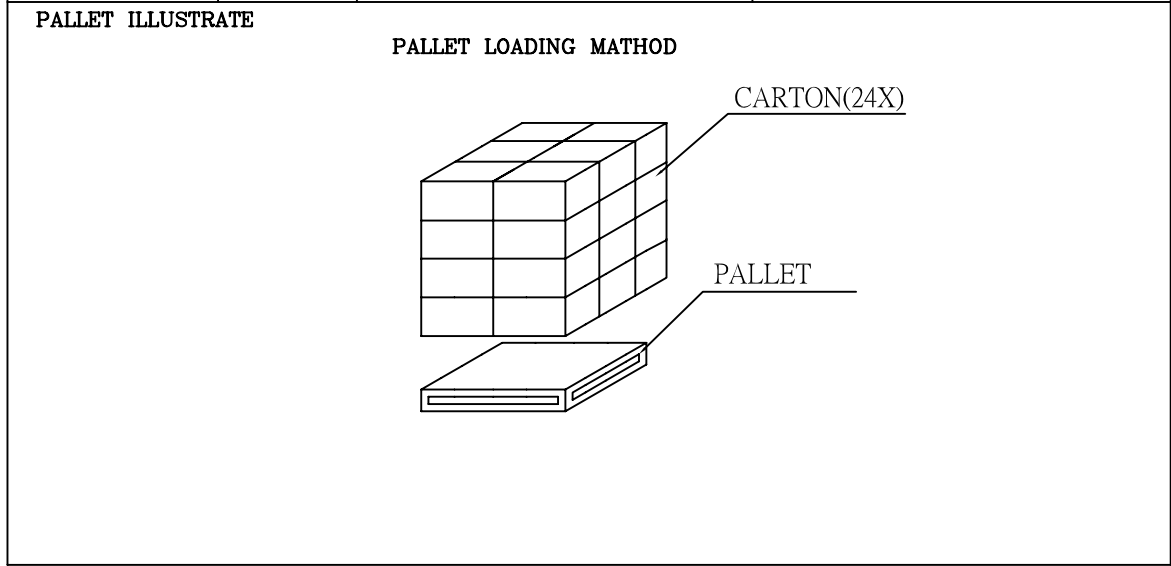

台達電子工業股份有限公司 DELTA ELECTRONICS, INC.	DELTA MODEL:	FHS-A9020S01	Drawn:	Skyler Huang
	THESE DRAWINGS AND SPECIFICATIONS ARE THE PROPERTY OF DELTA ELECTRONICS, INC. AND SHALL NOT BE REPRODUCED OR USED AS THE BASIS FOR THE MANUFACTURE OR SELL OF APPARATUS OR DEVICES WITHOUT PERMISSION.	CUSTOMER NAME:	-----	CUSTOMER P/N:
DIMENSIONAL TOLERANCES () () () HOLES : ±0.05 ANGLES : ±0.5° <30 :±0.25 DECIMALS UP~100 :±0.2 250~300 :±0.4 UP~600 :±1.5 >30~100 :±0.35 X :±0.3 100~150 :±0.25 300~350 :±0.45 600~900 :±2.4 >100~300 :±0.5 XX :±0.2 150~200 :±0.3 350~400 :±0.5 900~OVER :±3.1 ABOVE 300 :±0.6 XXX :±0.1 200~250 :±0.35	Description: PRODUCTION SPEC. (PACKING ASSMEBLY)	Part No. FHS-A9020S01-PA	REV. ---	
SCALE --- UNIT mm USED ON COOLER	A4 SIZE	SHEET 2 OF 2	ISSUE DATE:	---



Delta Electronics Corp.

4. FAN

Fan Specification



SPECIFICATION FOR APPROVAL

Customer T M P B U

Description DC FAN

Part No. 3622918011 REV.

Delta Model No. AUC0912D-9B37 REV. 01

Sample Issue No.

Sample Issue Date NOV.03.2009

PLEASE SEND ONE COPY OF THIS SPECIFICATION
BACK AFTER YOU SIGNED APPROVAL FOR
PRODUCTION PRE-ARRANGMENT.

APPROVED BY: _____

DATE : _____

DELTA ELECTRONICS, INC.
TAOYUAN PLANT
252, SHANG YING ROAD, KUEI SAN INDUSTRIAL ZONE
TAOYUAN SHIEN, TAIWAN, R.O.C.
TEL:886-(0)3-3591968
FAX:886-(0)3-3591991

DELTA ELECTRONICS, INC.
 252, SHANG YING ROAD, KUEI SAN
 TAOYUAN HSIEN 333, TAIWAN, R. O. C.

TEL : 886-(0)3-3591968
 FAX : 886-(0)3-3591991

SPECIFICATION FOR APPROVAL

Customer:	TMPBU	
Description:	DC FAN	
Customer P/N:	3622918011	REV:
Delta Model NO.:	AUC0912D-9B37	
Sample Rev:	01	Issue NO:
Sample Issue Date:	NOV.03.2009	Quantity:

1. SCOPE:

THIS SPECIFICATION DEFINES THE ELECTRICAL AND MECHANICAL CHARACTERISTICS OF THE DC BRUSHLESS AXIAL FLOW FAN. THE FAN MOTOR IS WITH SINGLE PHASE AND FOUR POLES.

2. CHARACTERS:

ITEM	DESCRIPTION	
SENSOR TEMPERATURE	30°C	39°C
RATED VOLTAGE	12.0 VDC	
OPERATION VOLTAGE	10.8 - 13.2 VDC	
START UP CURRENT	MAX. 1.0A	MAX. 1.2A
INPUT CURRENT	0.11 (MAX. 0.24) A	0.22 (MAX. 0.46) A
INPUT POWER	1.32 (MAX. 2.88) W	2.64 (MAX. 5.52) W
SPEED (FAN ONLY)	2050±200 R.P.M.	3000±10% R.P.M.
SPEED (FAN ON SINK)	2000±200 R.P.M.	2900±10% R.P.M.
MAX. AIR FLOW (FAN ONLY) (AT ZERO STATIC PRESSURE)	0.705 (MIN. 0.635) M ³ /MIN. 24.88 (MIN. 22.39) CFM	1.032 (MIN. 0.929) M ³ /MIN. 36.44 (MIN. 32.80) CFM
MAX. AIR PRESSURE (FAN ONLY) (AT ZERO AIRFLOW)	1.45 (MIN. 1.17) mmH ₂ O 0.057 (MIN. 0.046) inchH ₂ O	2.88 (MIN. 2.33) mmH ₂ O 0.114 (MIN. 0.092) inchH ₂ O
ACOUSTICAL NOISE(ON SINK AVG.)	30.0 (MAX. 34.0) dB-A	40.0 (MAX. 44.0) dB-A
INSULATION TYPE	UL: CLASS A	

(continued)

PART NO: 3622918011

DELTA MODEL: AUC0912D-9B37

INSULATION STRENGTH	10 MEG OHM MIN. AT 500 VDC (BETWEEN FRAME AND (+) TERMINAL)
DIELECTRIC STRENGTH	5 mA MAX. AT 500 VAC 50/60 Hz ONE MINUTE, (BETWEEN FRAME AND (+) TERMINAL)
EXTERNAL COVER	OPEN TYPE
LIFE EXPECTANCE	80,000 HOURS CONTINUOUS OPERATION AT 45 °C WITH 15 ~ 65 %RH.
ROTATION	CLOCKWISE VIEW FROM NAME PLATE SIDE
OVER CURRENT SHUT DOWN	THE CURRENT WILL SHUT DOWN WHEN LOCKING ROTOR
LEAD WIRE	UL 1430 -F- AWG #26 BLACK WIRE:NEGATIVE(-) YELLOW WIRE:POSITIVE(+) GREEN WIRE:TACHOMETER OUTPUT (FO0) BLUE WIRE:SPEED CONTROL (PWM)

- NOTES: 1. ALL READINGS ARE MEASURED AFTER STABLY WARMING UP THROUGH 10 MINUTES.
2. THE VALUES WRITTEN IN PARENS , (), ARE LIMITED SPEC.
3. ACOUSTICAL NOISE MEASURING CONDITION:

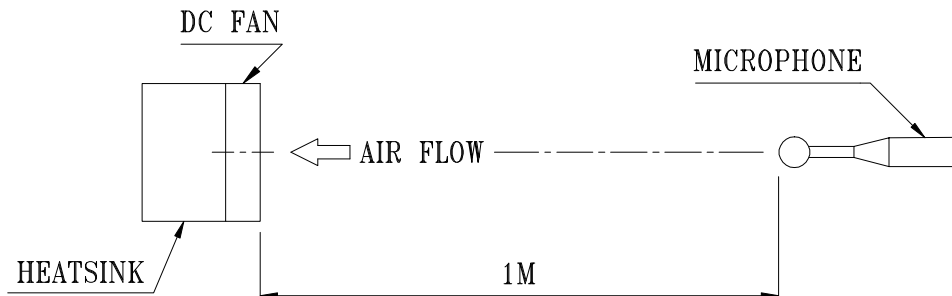

NOISE IS MEASURED AT RATED VOLTAGE IN FREE AIR IN ANECHOIC CHAMBER WITH B & K SOUND LEVEL METER WITH MICROPHONE AT A DISTANCE OF ONE METER FROM THE FAN INTAKE.

PART NO: 3622918011

DELTA MODEL: AUC0912D-9B37

3. MECHANICAL:

- 3-1. DIMENSIONS ----- SEE DIMENSIONS DRAWING
- 3-2. FRAME ----- PLASTIC UL: 94V-0
- 3-3. IMPELLER ----- PLASTIC UL: 94V-0
- 3-4. BEARING SYSTEM ----- SUPERFLO BEARINGS
- 3-5. WEIGHT ----- 80 GRAMS

4. ENVIRONMENTAL:

- 4-1. OPERATING TEMPERATURE ----- -10 TO +70 DEGREE C
- 4-2. STORAGE TEMPERATURE ----- -35 TO +85 DEGREE C
- 4-3. OPERATING HUMIDITY --- 85% RELATIVE HUMIDITY WITH 55 DEGREE C
- 4-4. STORAGE HUMIDITY ----- 5 TO 95 % RH

5. PROTECTION:

- 5-1. LOCKED ROTOR PROTECTION
IMPEDANCE OF MOTOR WINDING PROTECTS MOTOR FROM FIRE IN 96 HOURS OF LOCKED ROTOR CONDITION AT THE RATED VOLTAGE.
- 5-2. POLARITY PROTECTION
BE CAPABLE OF WITHSTANDING IF REVERSE CONNECTION FOR POSITIVE AND NEGATIVE LEADS.

6. RE OZONE DEPLETING SUBSTANCES:

- 6-1. NO CONTAINING PBBs, PBBOs, CFCs, PBBEs, PBDPEs AND HCFCs.

7. PRODUCTION LOCATION

- 7-1. PRODUCTS WILL BE PRODUCED IN CHINA OR THAILAND OR TAIWAN.

 PART NO: 3622918011

 DELTA MODEL: AUC0912D-9B37

8. P & Q CURVE:
 PWM 100% DUTY CYCLE

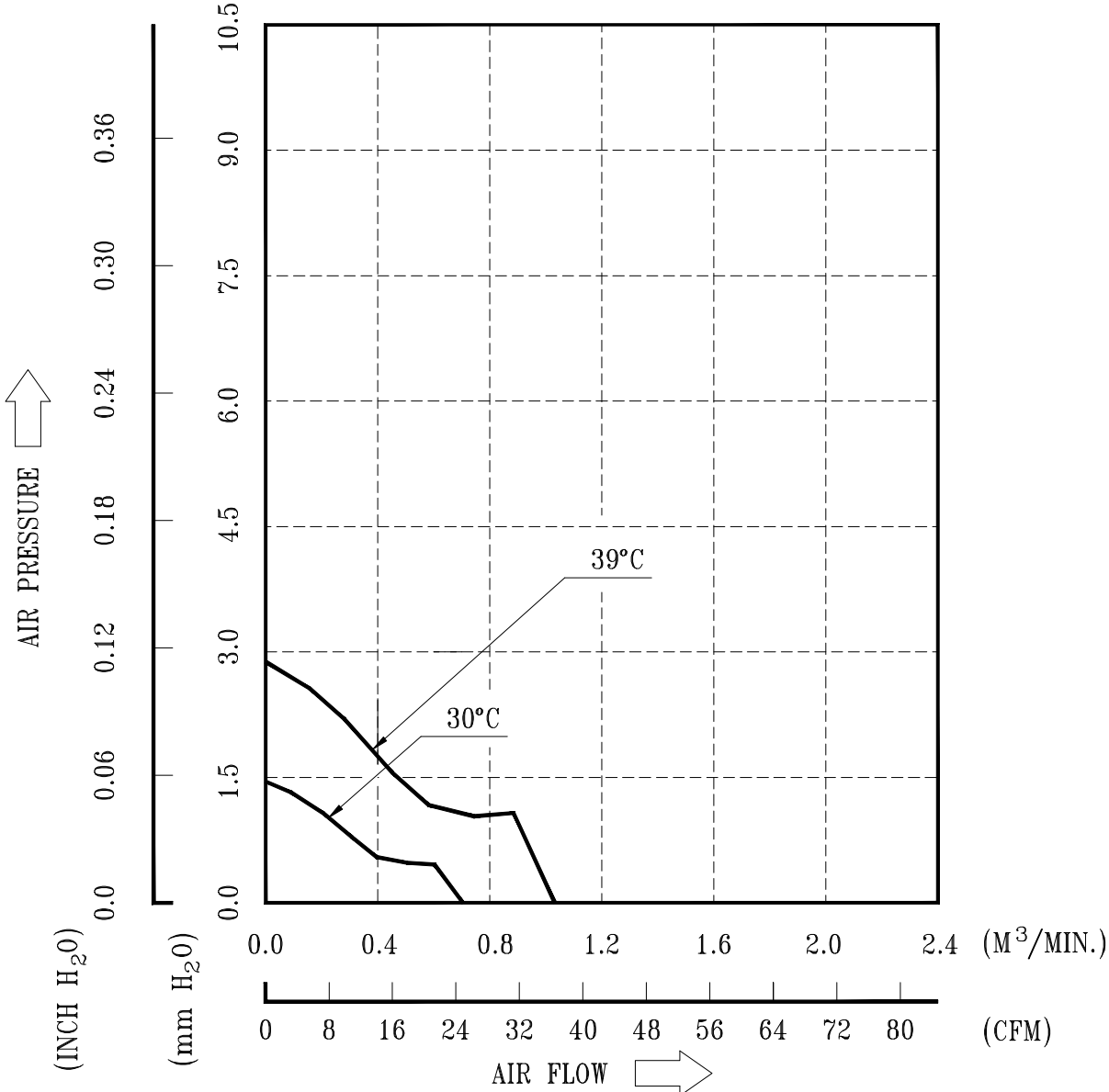

* TEST CONDITION: INPUT VOLTAGE ----- OPERATION VOLTAGE
 TEMPERATURE ----- ROOM TEMPERATURE
 HUMIDITY ----- 65%RH

PART NO: 3622918011

DELTA MODEL: AUC0912D-9B37

9. DIMENSION DRAWING:

LABEL:

DELTA AUC0912D
-9B37
yymmdd
CHINA

OR

DELTA AUC0912D
-9B37
yymmdd
THAILAND

OR

DELTA AUC0912D
-9B37
yymmdd
TAIWAN

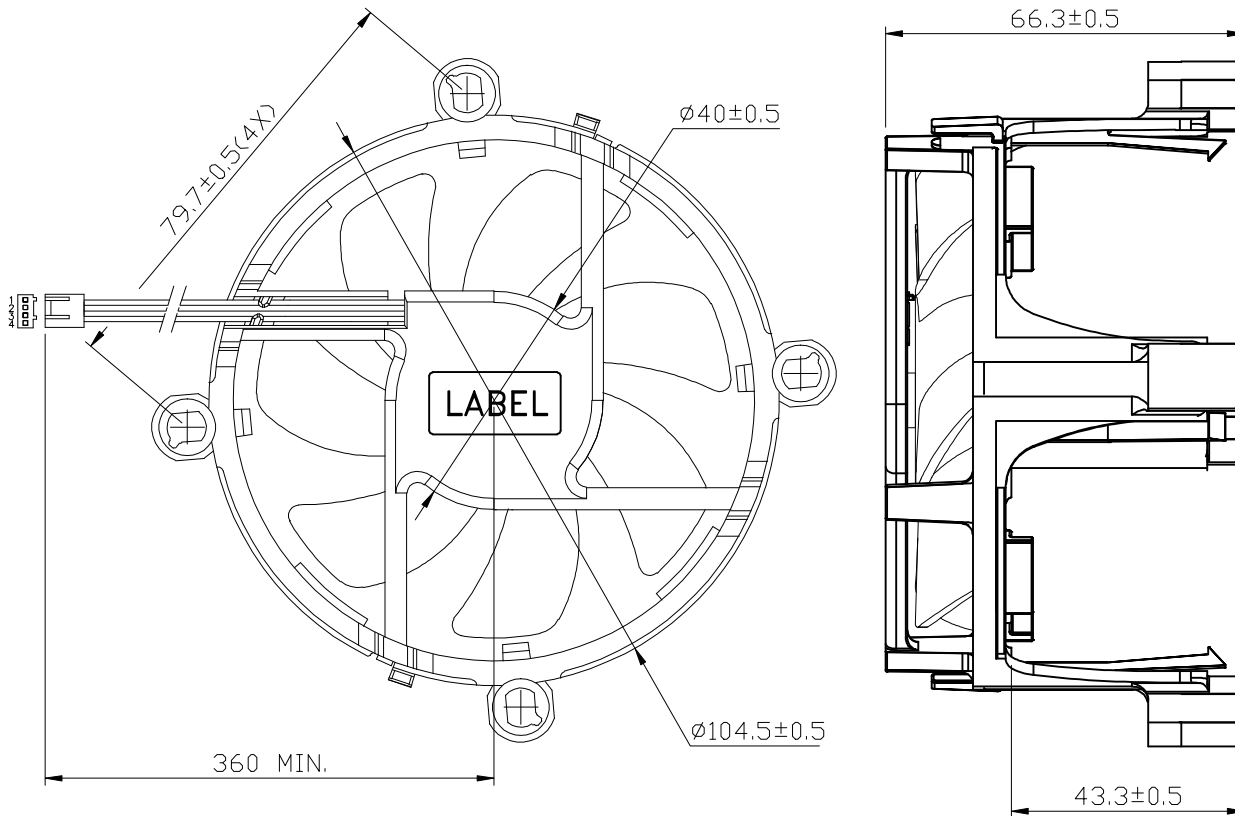

- NOTE : 1. LEAD WIRE: UL 1430 -F- AWG #26
PIN 1 : BLACK WIRE: NEGATIVE(-)
PIN 2 : YELLOW WIRE: POSITIVE(+)
PIN 3 : GREEN WIRE: TACHOMETER OUTPUT (F00)
PIN 4 : BLUE WIRE: SPEED CONTROL (PWM)
2. HOUSING : MOLEX 47054-1000 OR EQUIVALENT
3. TERMINAL : MOLEX 2759T 08-50-0113 OR EQUIVALENT
4. THIS PRODUCT IS RoHS COMPLIANT

UNIT: MM

PART NO: 3622918011

DELTA MODEL: AUC0912D-9B37

10. FREQUENCY GENERATOR (FG) SIGNAL:

1. OUTPUT CIRCUIT - OPEN COLLECTOR MODE:

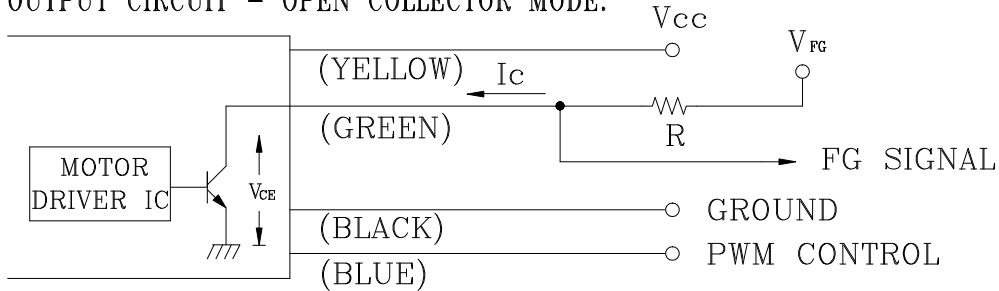

CAUTION: THE FG SIGNAL LEAD WIRE MUST BE KEPT AWAY FROM
" + " LEAD WIRE & " - " LEAD WIRE.

2. SPECIFICATION:

$$V_{ce(sat)} = 0.5V$$

$$V_{FG} = 5.0V \text{ TYP. (} V_{cc} \text{ MAX.)}$$

$$I_c = 10mA \text{ MAX.}$$

$$R \geq V_{FG} / I_c$$

3. FREQUENCY GENERATOR WAVEFORM:

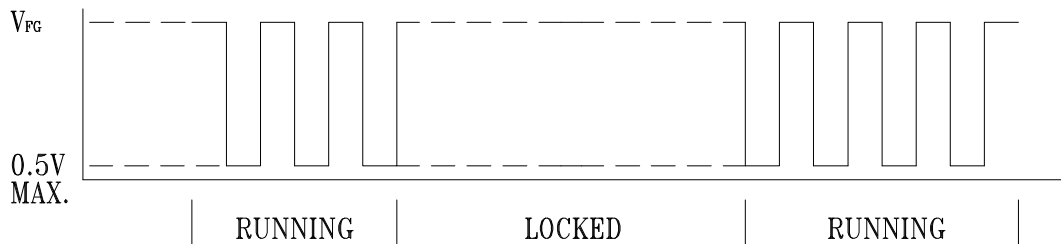

FAN RUNNING FOR 4 POLES

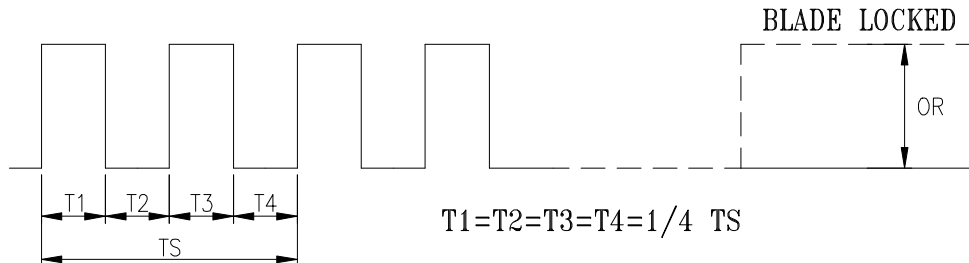

$$N = \text{R.P.M}$$

$$TS = 60 / N (\text{SEC})$$

*VOLTAGE LEVEL AFTER BLADE LOCKED

*4 POLES

PART NO: 3622918011

DELTA MODEL: AUC0912D-9B37

11. PWM CONTROL FUNCTION:(FAN ON SINK)

11-1 SIGNAL DESCRIPTION:

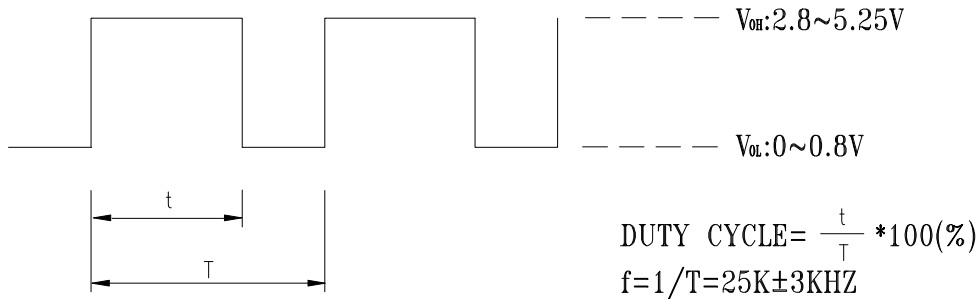

- AT 25K HZ 30% DUTY CYCLE, THE FAN WILL BE ABLE TO START FROM A DEAD STOP.

11-2 SPEED CONTROL

TEST CONDITION : INPUT VCC=12V PWM FREQUENCY=25KHZ

11-2-1 TEMPERATURE CONTROL

BELOW 30 DEGREE C, THE FAN SPEED IS 2000RPM.

ABOVE 39 DEGREE C, THE FAN SPEED IS 2900RPM.

BETWEEN 30~39 DEGREE C, THE FAN SPEED IS 2000RPM~2900RPM.

11-2-2 PWM CONTROL

BELOW 30 DEGREE C

BETWEEN 0%~100% DUTY CYCLE, THE FAN SPEED IS 1000RPM~2000RPM.

ABOVE 39 DEGREE C

BETWEEN 0%~100% DUTY CYCLE, THE FAN SPEED IS 1000RPM~2900RPM.

TEMPERATURE (°C)	DUTY CYCLE (%)	SPEED R.P.M.
30	0~20	1000±200
30	100	2000±10%
39	0~20	1000±200
39	100	2900±10%

- IF THE CONTROL SIGNAL IS DISCONNECT THE FAN WILL GO TO TEMPERATURE CONTROL SPEED.

PART NO: 3622918011

DELTA MODEL: AUC0912D-9B37

12. PWM CONTROL FUNCTION:(FAN ONLY)

12-1 SIGNAL DESCRIPTION:

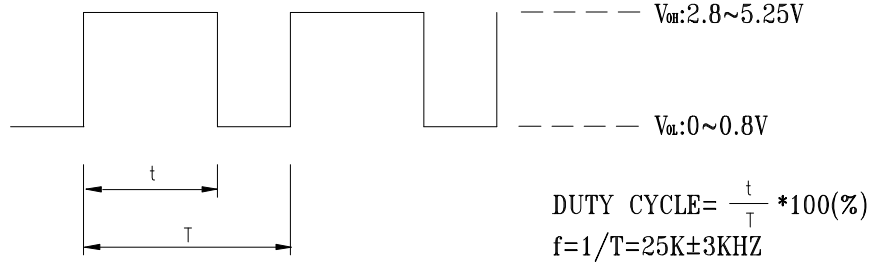

- AT 25K HZ 30% DUTY CYCLE, THE FAN WILL BE ABLE TO START FROM A DEAD STOP.

12-2 SPEED CONTROL

TEST CONDITION : INPUT VCC=12V PWM FREQUENCY=25KHZ

12-2-1 TEMPERATURE CONTROL

BELOW 30 DEGREE C, THE FAN SPEED IS 2050RPM.

ABOVE 39 DEGREE C, THE FAN SPEED IS 3000RPM.

BETWEEN 30~39 DEGREE C, THE FAN SPEED IS 2050RPM~3000RPM.

12-2-2 PWM CONTROL

BELOW 30 DEGREE C

BETWEEN 0%~100% DUTY CYCLE, THE FAN SPEED IS 1050RPM~2050RPM.

ABOVE 39 DEGREE C

BETWEEN 0%~100% DUTY CYCLE, THE FAN SPEED IS 1050RPM~3000RPM.

TEMPERATURE (°C)	DUTY CYCLE (%)	SPEED R.P.M.
30	0~20	1050±200 R.P.M.
30	100	2050±200 R.P.M.
39	0~20	1050±200 R.P.M.
39	100	3000±10% R.P.M.

- IF THE CONTROL SIGNAL IS DISCONNECT THE FAN WILL GO TO TEMPERATURE CONTROL SPEED.

13. PWM CONTROL LEAD WIRE INPUT IMPEDANCE:

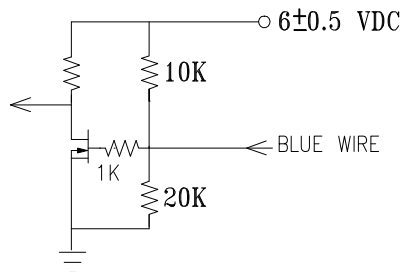



Application Notice

- 1. Delta will not guarantee the performance of the products if the application condition falls outside the parameters set forth in the specification.**
- 2. A written request should be submitted to Delta prior to approval if deviation from this specification is required.**
- 3. Please exercise caution when handling fans. Damage may be caused when pressure is applied to the impeller, if the fans are handled by the lead wires, or if the fan was hard-dropped to the production floor.**
- 4. Except as pertains to some special designs, there is no guarantee that the products will be free from any such safety problems or failures as caused by the introduction of powder, droplets of water or encroachment of insect into the hub.**
- 5. The above-mentioned conditions are representative of some unique examples and viewed as the first point of reference prior to all other information.**
- 6. It is very important to establish the correct polarity before connecting the fan to the power source. Positive (+) and Negative (-). Damage may be caused to the fans if connection is with reverse polarity, if there is no foolproof method to protect against such error specifically mentioned in this spec.**
- 7. Delta fans without special protection are not suitable where any corrosive fluids are introduced to their environment.**
- 8. Please ensure all fans are stored according to the storage temperature limits specified. Do not store fans in a high humidity environment. We highly recommend performance testing is conducted before shipping, if the fans have been stored over 6 months.**
- 9. Not all fans are provided with the Lock Rotor Protection feature. If you impair the rotation of the impeller for the fans that do not have this function, the performance of those fans will lead to failure.**
- 10. Please be cautious when mounting the fan. Incorrect mounting of fans may cause excess resonance, vibration and subsequent noise.**
- 11. It is important to consider safety when testing the fans. A suitable fan guard should be fitted to the fan to guard against any potential for personal injury.**
- 12. Except where specifically stated, all tests are carried out at room (ambient) temperature and relative humidity conditions of 25°C, 65% RH. The test value is only for fan performance itself.**
- 13. Be certain to connect an “4.7µF or greater” capacitor to the fan externally when the application calls for using multiple fans in parallel, to avoid any unstable power.**