

926097

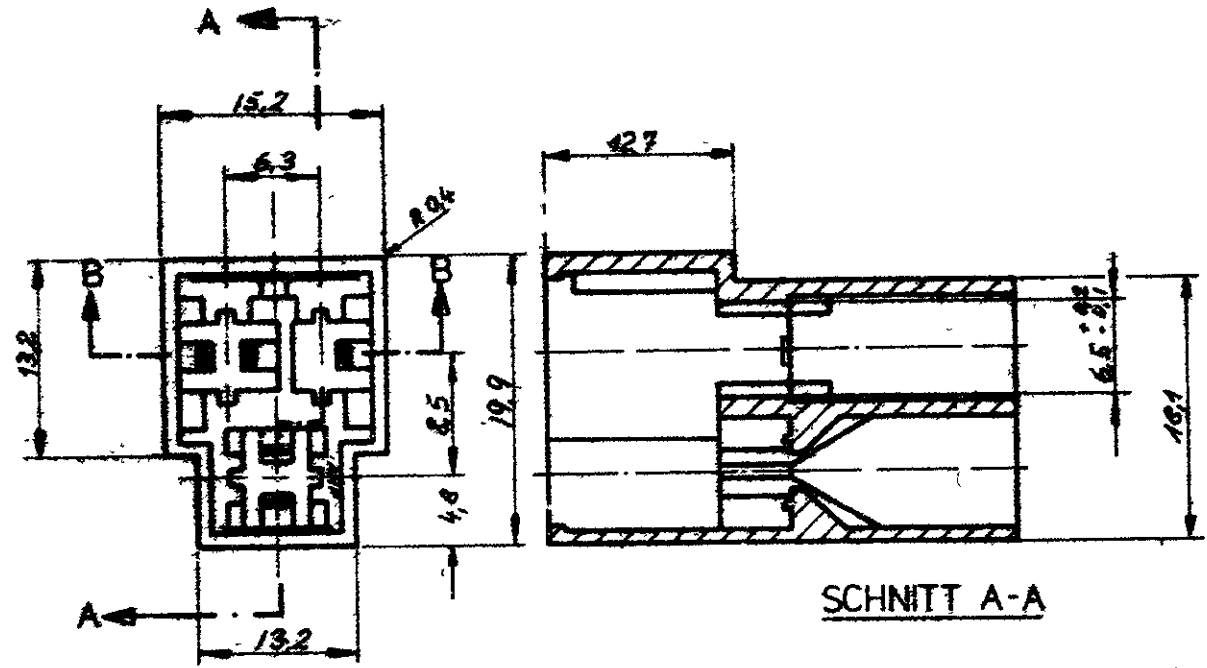

SCHNITT A-A

Änderungen, die dem technischen Fortschritt dienen, behalten wir uns vor

1.0 : 2.00

Schnitt B-B

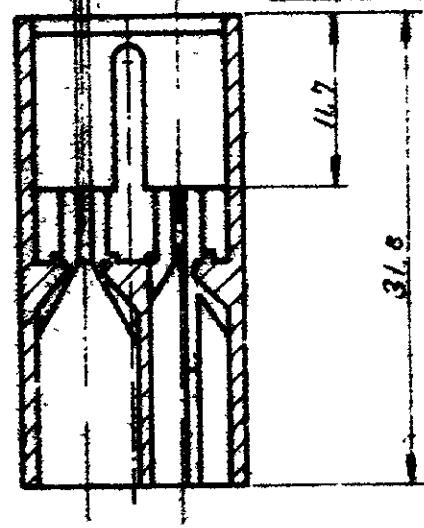

△ OBSOLETE PARTS: OBSOLETE CIS STREAMLINING PER D.RENAUD/D.SINSI

1-926097-1	PA 6.6	ORANGE
926097-9	↑	VIOLETT
△ 926097-8		GRAU
926097-7		BRAUN
△ 926097-6		ROT
926097-5		GRÜN
△ 926097-4		BLAU
△ 926097-3		GELB
926097-2	↓	SCHWARZ
926097-1	PA 6.6	NATUR
Bestell-Nr.	Material	Farbe

DIMENSIONS IN MILLIMETERS. DO NOT SCALE PRINT.

CUSTOMER COPY REFERENCE ONLY

MATERIAL AND FINISH: **SIEHE TABELLE**

TE TE Connectivity

CLASS

WIRE - RANGE - INSULATION: TYPE

A2	REVISED PER ECO-11-005140	RK	HMR	31MAR11
LTR	REVISION RECORD	DR	CHK	DATE
DR	25.10.77 <i>Reitzmisch</i>	DE		
CHK	<i>[Signature]</i>	APP		

TOLERANCE EXCEPT AS NOTED	SCALE	LGC	NO	REV
± 0.2 ± 0.5	2:1	M	926097	A2
NAME: 3pol. FASTIN-FASTON Flachsteckergehäuse				