

REV.	DATE	DESCRIPTION
NC	04/29/99	INITIAL RELEASE
A	05/08/07	REVISE BARREL, FERRULE DIMS, UPDATE DRAWING FORMAT

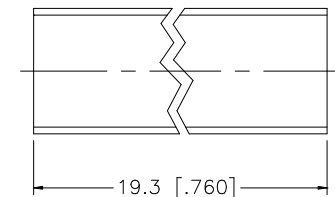
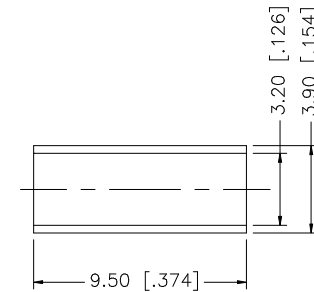
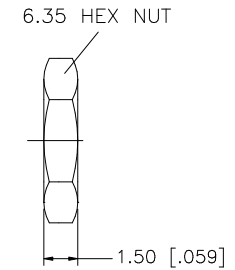
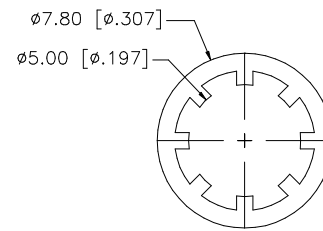
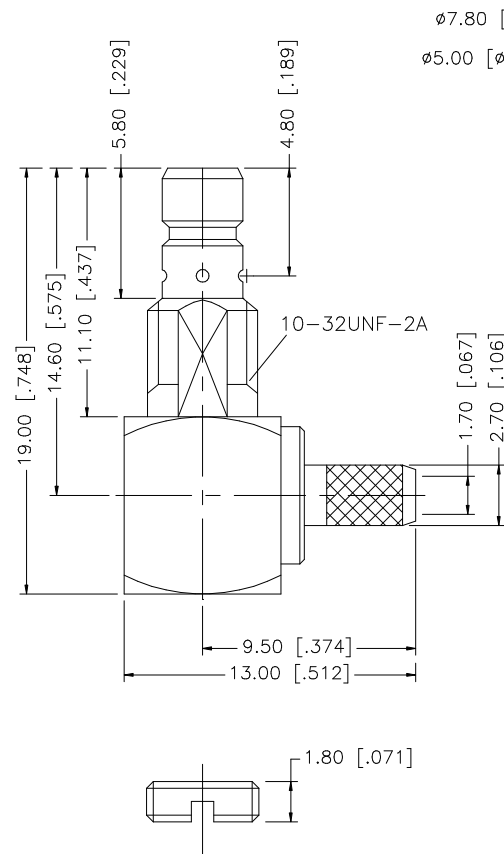
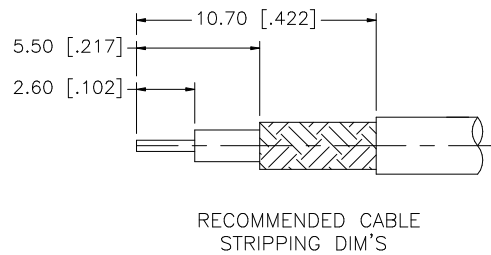
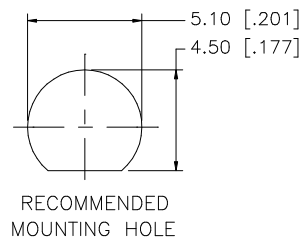

NOTE:

1. CRIMPED FERRULE HEX CRIMP SIZE .128"
2. CONTACT PIN TO SOLDER.

QTY	DESCRIPTION	MATERIAL	FINISH
8			
7	COVER	BRASS	GOLD
6	FERRULE	COPPER	GOLD
5	HEX NUT	BRASS	GOLD
4	LOCK WASHER	BRASS	GOLD
3	CONTACT PIN	BRASS	GOLD
2	INSULATOR	TEFLON	NATURAL
1	BODY	BRASS	GOLD

UNLESS OTHERWISE SPECIFIED DIMENSIONS ARE IN MILLIMETERS. DIMENSIONS IN [] ARE IN INCHES AND FOR CUSTOMER REFERENCE ONLY.

UNLESS OTHERWISE SPECIFIED TOLERANCES FOR MILLIMETERS ARE:
0.5 - 8mm ± 0.20mm
8 - 30mm ± 0.40mm
30 - 120mm ± 0.50mm

UNLESS OTHERWISE SPECIFIED TOLERANCES FOR INCHES ARE:
.020 - .315 = ± 0.007"
.315 - 1.180 = ± 0.015"
1.180 - 4.724 = ± 0.020"

DO NOT SCALE DRAWING

APPROVALS	DATE
DRAWN G.R.S.	05/08/07
CHECKED	
ISSUED	
SHEET 1 OF 1	
CAD FILE	C:/142/142233.DWG

Amphenol Connex

PART DESCRIPTION

SMB R/A BULKHEAD CRIMP JACK
(FOR RG-174/U, 188A/U, 316/U)

PART NO.

142233

DWG. NO.

142233.DWG

REV. A

SIZE A

SCALE NA