

OLIVIA-M

~60° medium beam

TECHNICAL SPECIFICATIONS:

Dimensions	Ø 70 mm
Height	22.6 mm
Fastening	screw
Colour	clear
Box size	
Box weight	0 kg
Quantity in Box	140 pcs
ROHS compliant	yes ⓘ

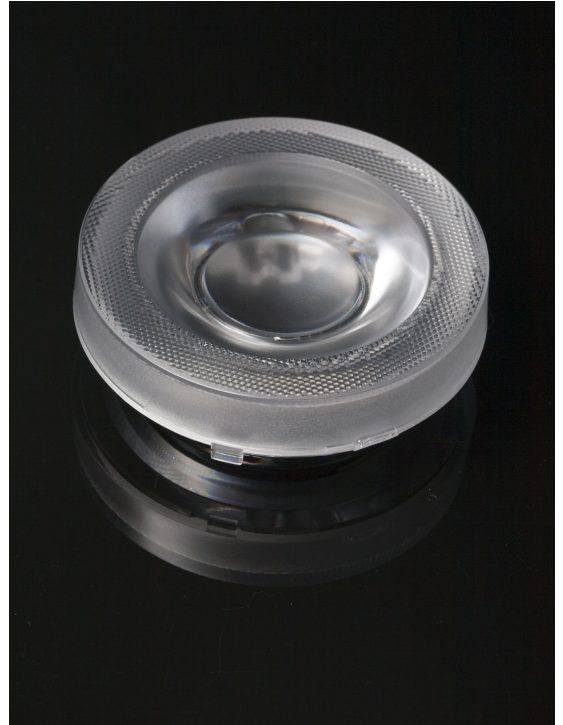

MATERIAL SPECIFICATIONS:



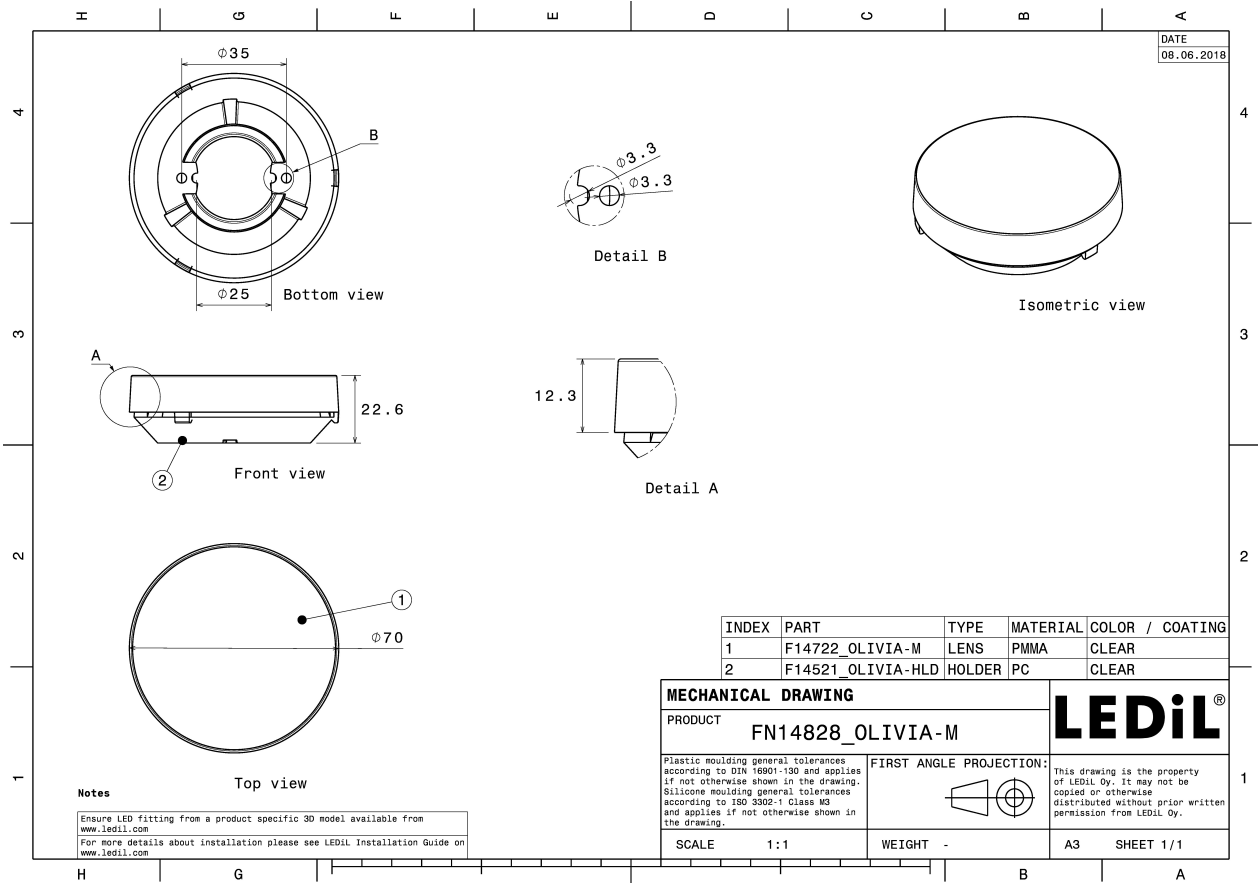

Component	Type	Material	Colour
OLIVIA-M	Lens	PC	clear
OLIVIA-HLD	Holder	PC	clear

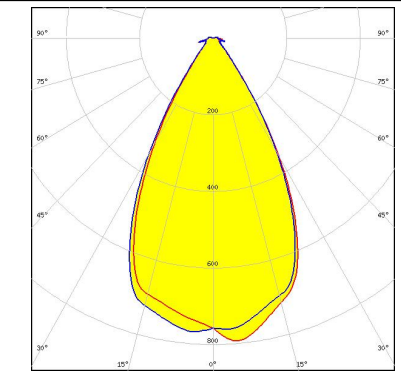
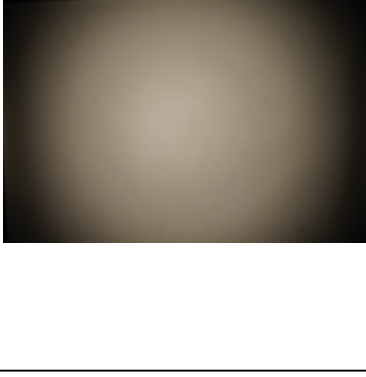
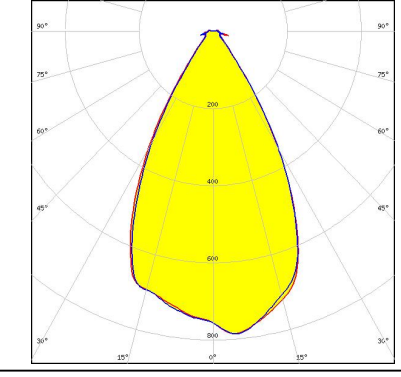
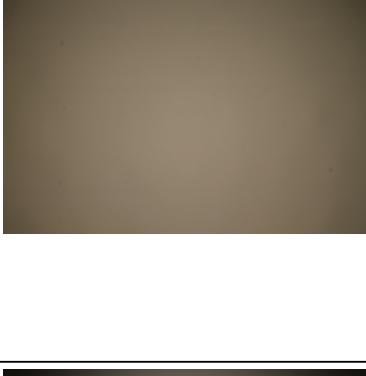
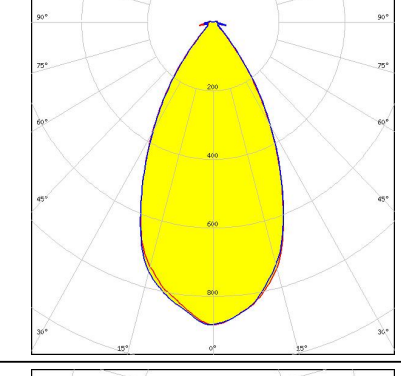
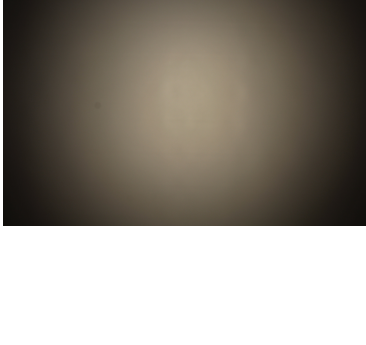
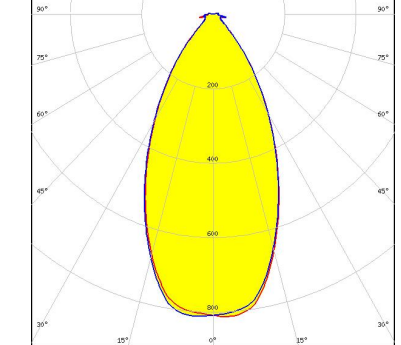

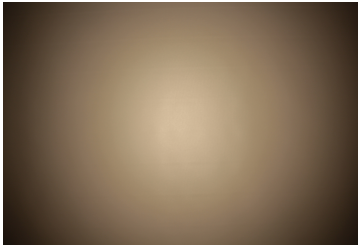
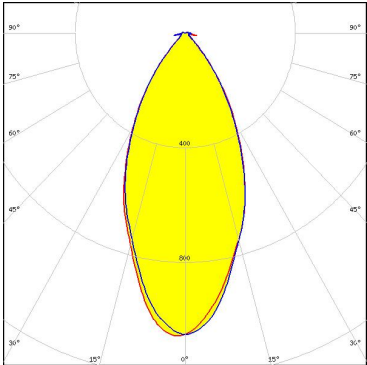

PHOTOMETRIC DATA (MEASURED):

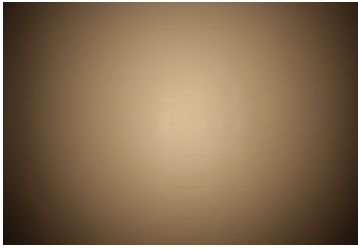
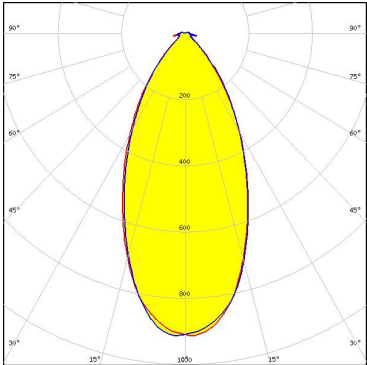
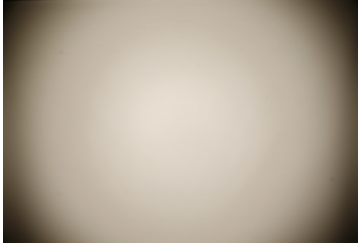
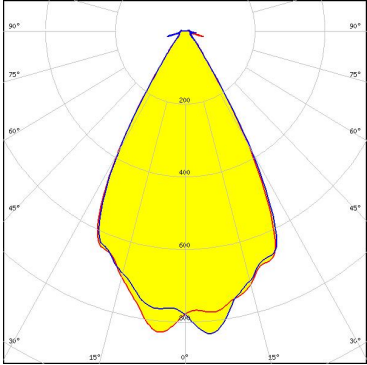
<p>bridgelux.</p> <p>LED V10 Gen6</p> <p>FWHM 58.0°</p> <p>Efficiency 76 %</p> <p>Peak intensity 0.790 cd/lm</p> <p>Required components: BJB: 47.319.6214</p>		
<p>bridgelux.</p> <p>LED V10 Gen7</p> <p>FWHM 57.0°</p> <p>Efficiency 76 %</p> <p>Peak intensity 0.800 cd/lm</p> <p>Required components: BJB: 47.319.6060</p>		
<p>bridgelux.</p> <p>LED Vero SE 13</p> <p>FWHM 54.0°</p> <p>Efficiency 80 %</p> <p>Peak intensity 0.880 cd/lm</p> <p>Required components:</p>		
<p>bridgelux.</p> <p>LED Vero SE 18</p> <p>FWHM 52.0°</p> <p>Efficiency 78 %</p> <p>Peak intensity 0.820 cd/lm</p> <p>Required components:</p>		

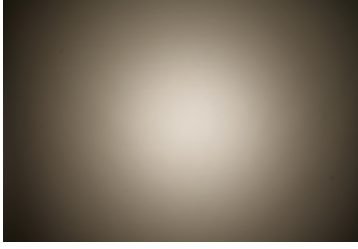
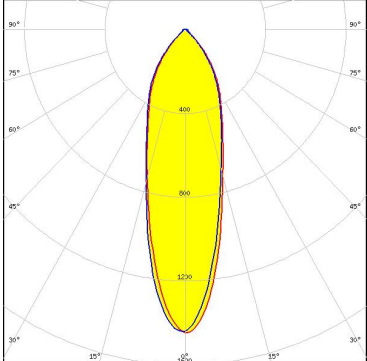
PHOTOMETRIC DATA (MEASURED):

<p></p> <p>LED Xenio Point 13mm FWHM 48.0° Efficiency 83 % Peak intensity 1.060 cd/lm Required components:</p>		
<p></p> <p>LED Xenio Point 18mm FWHM 49.0° Efficiency 81 % Peak intensity 0.920 cd/lm Required components:</p>		
<p>CITIZEN</p> <p>LED CLU700/701 FWHM 59.0° Efficiency 77 % Peak intensity 0.900 cd/lm Required components: A.A.G. STUCCHI: 8100/G2</p>		
<p></p> <p>LED CXA/B 1816 & CXA/B 1820 & CXA 1850 FWHM 30.0° Efficiency 82 % Peak intensity 1.500 cd/lm Required components:</p>		

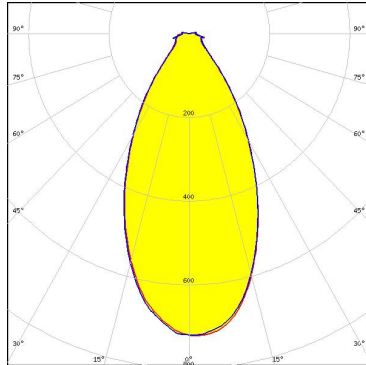
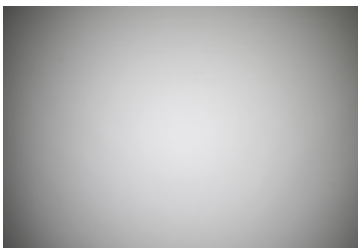
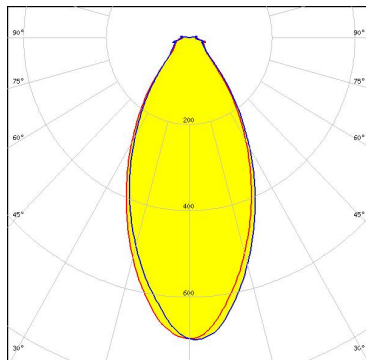
PHOTOMETRIC DATA (MEASURED):

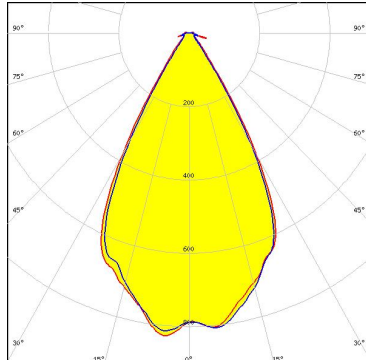
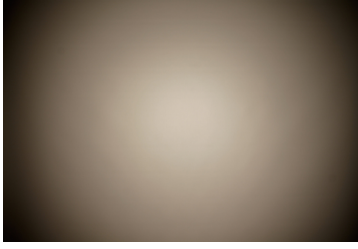
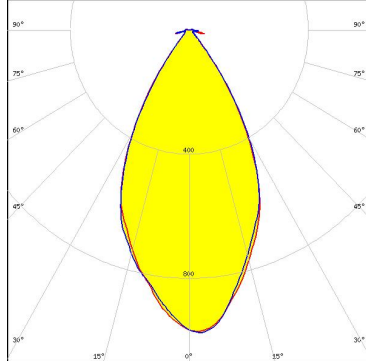
<p>LUMILEDS</p> <p>LED LUXEON CoB 1211</p> <p>FWHM 52.0°</p> <p>Efficiency 74 %</p> <p>Peak intensity 0.720 cd/lm</p> <p>Required components: BJB: 47.319.2030</p>		
<p>LUMILEDS</p> <p>LED LUXEON CoB 1216/1812</p> <p>FWHM 51.0°</p> <p>Efficiency 72 %</p> <p>Peak intensity 0.700 cd/lm</p> <p>Required components: BJB: 47.319.2030</p>		
<p>LUMILEDS</p> <p>LED LUXEON CoB Compact</p> <p>FWHM 58.0°</p> <p>Efficiency 77 %</p> <p>Peak intensity 0.830 cd/lm</p> <p>Required components: BJB: 47.319.6180</p>		
<p>PHILIPS</p> <p>LED Fortimo SLM L09 Poke-In</p> <p>FWHM 54.0°</p> <p>Efficiency 81 %</p> <p>Peak intensity 0.980 cd/lm</p> <p>Required components:</p>		

PHOTOMETRIC DATA (MEASURED):

PHILIPS

LED Fortimo SLM L13 Poke-In
 FWHM 53.0°
 Efficiency 78 %
 Peak intensity 0.870 cd/lm
 Required components:

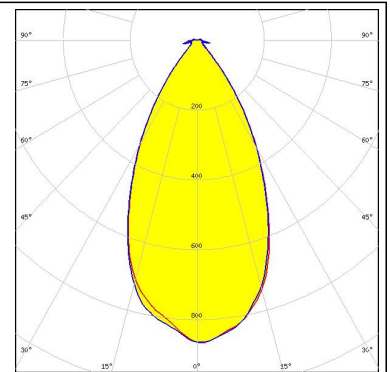
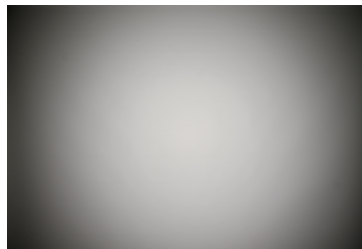

PHILIPS

LED Fortimo SLM L15 Poke-In
 FWHM 53.0°
 Efficiency 78 %
 Peak intensity 0.840 cd/lm
 Required components:

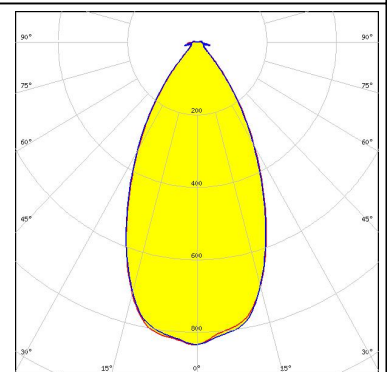
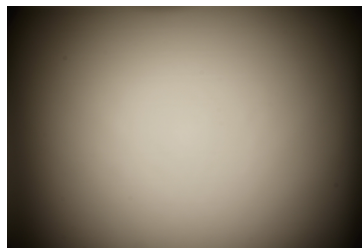

PHILIPS

LED Fortimo SLM L19 Poke-In
 FWHM 51.0°
 Efficiency 77 %
 Peak intensity 0.810 cd/lm
 Required components:

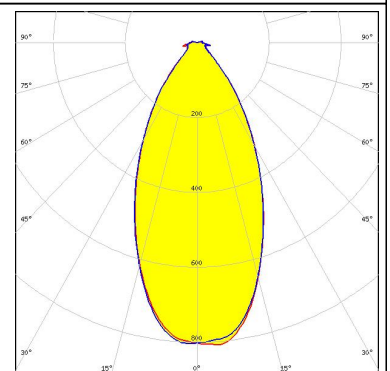
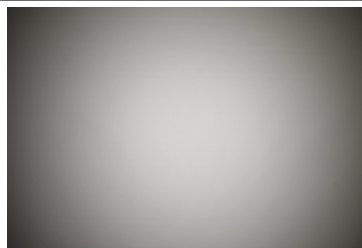

SAMSUNG

LED COB D Series LES 14.5 mm
 FWHM 55.0°
 Efficiency 76 %
 Peak intensity 0.750 cd/lm
 Required components:
 A.A.G. STUCCHI: 8101/G2

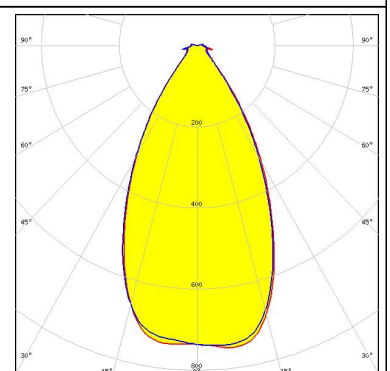
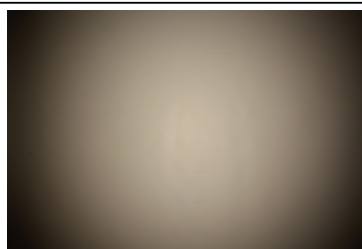

PHOTOMETRIC DATA (MEASURED):

SAMSUNG

LED COB D Series LES 14.5 mm
FWHM 55.0°
Efficiency 76 %
Peak intensity 0.750 cd/lm
Required components:
BJB: 47.319.2021

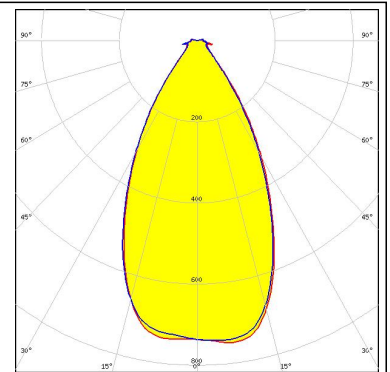
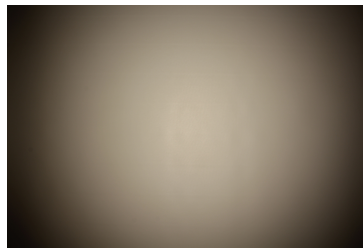

SAMSUNG

LED COB D Series LES 9.8 mm
FWHM 57.0°
Efficiency 77 %
Peak intensity 0.820 cd/lm
Required components:
BJB: 47.319.6060

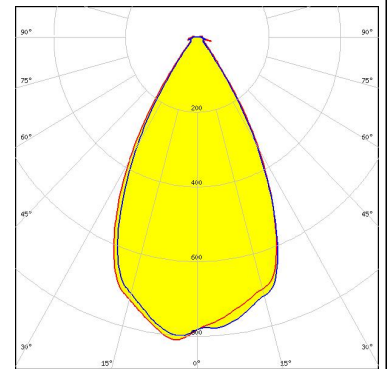

SAMSUNG

LED COB D Series LES 9.8 mm
FWHM 57.0°
Efficiency 77 %
Peak intensity 0.820 cd/lm
Required components:
A.A.G. STUCCHI: 8100/G2

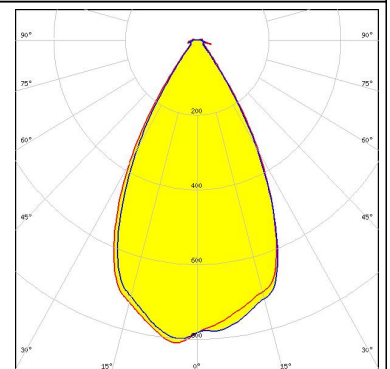

SHARP

LED Mini Zenigata (GW6BM)
FWHM 57.0°
Efficiency 77 %
Peak intensity 0.880 cd/lm
Required components:
BJB: 47.319.6180

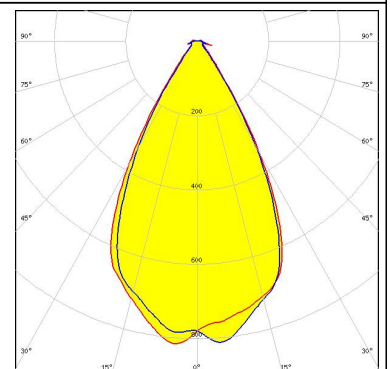
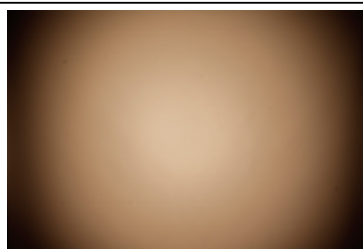

PHOTOMETRIC DATA (SIMULATED):

<p>bridgelux.</p> <p>LED V13 Gen7</p> <p>FWHM 50.0°</p> <p>Efficiency 93 %</p> <p>Peak intensity 1.100 cd/lm</p> <p>Required components: TE: 2213254-1</p>	
<p>bridgelux.</p> <p>LED V13 Gen7</p> <p>FWHM 44.0°</p> <p>Efficiency 94 %</p> <p>Peak intensity 1.270 cd/lm</p> <p>Required components: Bender Wirth: 477 Typ Z1</p>	
<p>bridgelux.</p> <p>LED V13 Gen7</p> <p>FWHM 43.0°</p> <p>Efficiency 90 %</p> <p>Peak intensity 0.860 cd/lm</p> <p>Required components: BJB: 47.319.2021</p>	
<p>bridgelux.</p> <p>LED V13 Gen7</p> <p>FWHM 58.0°</p> <p>Efficiency 89 %</p> <p>Peak intensity 0.800 cd/lm</p> <p>Required components: TE: 2213254-2</p>	

PHOTOMETRIC DATA (SIMULATED):

bridgelux.

LED V22 Gen7
FWHM 48.0°
Efficiency 82 %
Peak intensity 0.921 cd/lm
Required components:
BJB: 47.319.2030

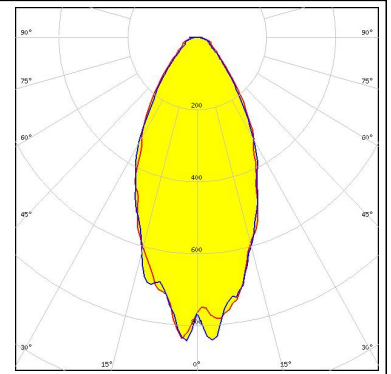

GENERAL INFORMATION:

NOTE: The typical beam angle will be changed by different color, chip size and chip position tolerance. The typical total beam angle is the full angle measured where the luminous intensity is half of the peak value.

Due to use of high power COB's with this product, special attention to proper thermal design is highly recommended. LEDiL has no liability for direct, indirect or consecutive damages arising from the LEDiL products being used outside of the recommended temperature range.

MATERIALS:

As part of our continuous research and improvement processes, and to ensure the best possible quality and availability of our products, LEDiL reserves the right to change material grades without notice.

PRODUCT DATA USER AGREEMENT AND DISCLAIMER:

The measured data in the provided downloadable LEDiL Product Datasheets and Mechanical 2D-Drawings is rounded and provided as reference for planning. LEDiL Oy's optical specifications have been verified by conducting performance testing of the products in accordance with the company's quality system. The reported data are averaged results of multiple measurements with typical variation. LEDiL Oy reserves the right to without prior notification make changes and improvements to its products.

LEDiL Oy assumes neither warranty, nor guarantee nor any other liability of any kind for the contents and correctness of the provided data. The provided data has been generated with highest diligence but the provided data may in reality not represent the complete possible variation range of all intrinsic parameters. Therefore, in certain cases a deviation from the provided data could occur.

LEDiL Oy reserves the right to undertake technical changes of its products without further notification which could lead to changes in the provided data. LEDiL Oy assumes no liability of any kind for the possible deviation from any provided data or any other damage resulting from the usage of the provided data.

The user agrees to this disclaimer and user agreement with the download or usage of the provided files.

LEDiL Oy

Joensuunkatu 13
FI-24240 SALO
Finland

LEDiL Inc.

228 West Page Street
Suite D
Sycamore IL 60178
USA

Local sales and technical support

[www.ledil.com/
where_to_buy](http://www.ledil.com/where_to_buy)

Shipping locations

Salo, Finland
Hong Kong, China

Distribution Partners

[www.ledil.com/
where_to_buy](http://www.ledil.com/where_to_buy)