

User Guide for  
FEBFSL126MR\_H432v1  
Evaluation Board

5V, 12V Green-Mode Fairchild Power  
Switch (FPS™)

Featured Fairchild Product:  
FSL126MR

***Direct questions or comments  
about this evaluation board to:  
“Worldwide Direct Support”***

***[Fairchild Semiconductor.com](http://Fairchild Semiconductor.com)***

## Table of Contents

1. Introduction.....	3
1.1. General Description .....	3
1.2. Features .....	3
2. General Specifications .....	4
3. Photographs.....	5
4. PCB Layout.....	6
5. Test Conditions and Items .....	7
6. Performance of Evaluation Board.....	8
6.1. Startup Performance.....	8
6.2. Normal Operation .....	10
6.3. Voltage Stress of Secondary Diodes and Drain.....	11
6.4. Output Ripple and Noise.....	12
6.5. Ripple and Noise Waveforms .....	13
6.6. Short Protections.....	14
6.7. Efficiency .....	18
6.9. Output Voltage Regulation .....	21
6.10. IC Temperature Measurement .....	21
6.11. Conducted EMI Measurements.....	22
7. Schematic.....	23
8. Line Filter and Inductor Specification .....	24
9. Transformer Specification .....	27
10. Bill of Materials .....	31
11. Revision History .....	32

This user guide supports the evaluation kit for the FSL126MR. It should be used in conjunction with the FSL126MR datasheet as well as Fairchild's application notes and technical support team. Please visit Fairchild's website at [www.fairchildsemi.com](http://www.fairchildsemi.com).

## 11. Introduction

This document is an engineering report describing measured performance of the FSL126MR.

### 1.1. General Description

The FSL126MR integrated Pulse Width Modulator (PWM) and SenseFET is specifically designed for high-performance offline Switch-Mode Power Supplies (SMPS) with minimal external components. FSL126MR includes integrated high-voltage power switching regulators that combine an avalanche-rugged SenseFET with a current-mode PWM control block.

The integrated PWM controller includes: Under-Voltage Lockout (UVLO) protection, Leading-Edge Blanking (LEB), a frequency generator for EMI attenuation, an optimized gate turn-on/turn-off driver, Thermal Shutdown (TSD) protection, and temperature-compensated precision current sources for loop compensation and fault protection circuitry. The FSL126MR offers good soft-start performance. When compared to a discrete MOSFET and controller or RCC switching converter solution, the FSL126MR reduces total component count, design size, and weight; while increasing efficiency, productivity, and system reliability. This device provides a basic platform that is well suited for the design of cost-effective flyback converters.

### 1.2. Features

- Internal Avalanche-Rugged SenseFET (650V)
- Under 50mW Standby Power Consumption at 265V<sub>AC</sub>, No-load Condition with Burst Mode
- Fixed Operating Frequency with Frequency Modulation for Attenuating EMI
- Internal Startup Circuit
- Built-in Soft-Start: 15ms
- Pulse-by-Pulse Current Limiting
- Protections: Over-Voltage Protection (OVP), Overload Protection (OLP), Output-Short Protection (OSP), Abnormal Over-Current Protection (AOCP), Internal Thermal Shutdown Function with Hysteresis (TSD)
- Auto-Restart Mode
- Under-Voltage Lockout (UVLO)
- Low Operating Current: 1.8mA
- Adjustable Peak Current Limit

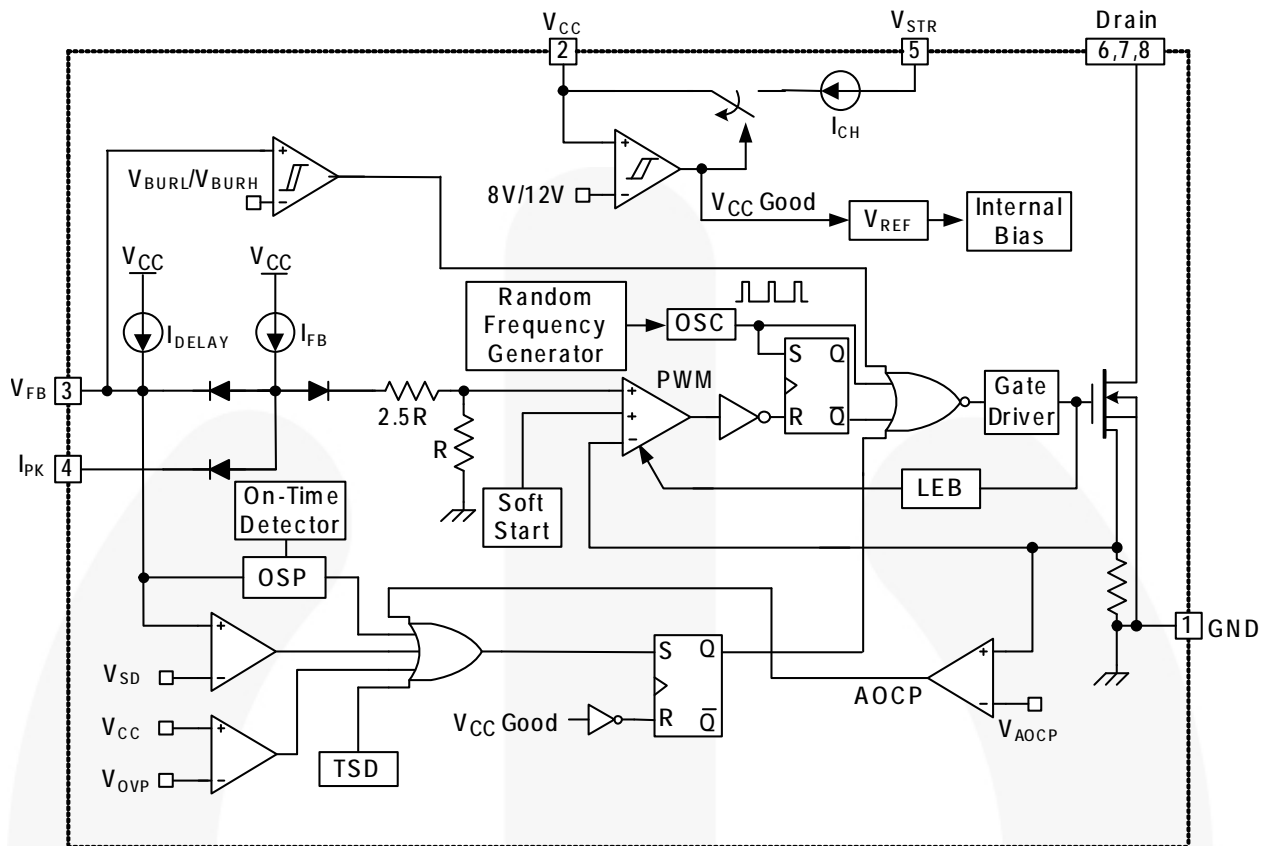


Figure 1. Internal Block Diagram

## 11. General Specifications

Specification	Min.	Max.	Units
<b>Input</b>			
Voltage	90	264	V <sub>AC</sub>
Frequency	47	63	Hz
<b>Output</b>			
Output Voltage 1		5	V
Output Current 1		1.8	A
Output Voltage 2		12	V
Output Current 2		0.4	A
<b>Total Output Power</b>			
Full-load Output Power		13.8	W

## 11. Photographs



**Figure 2.** Top View (Dimension 106 x 41[mm<sup>2</sup>])

## 11. PCB Layout

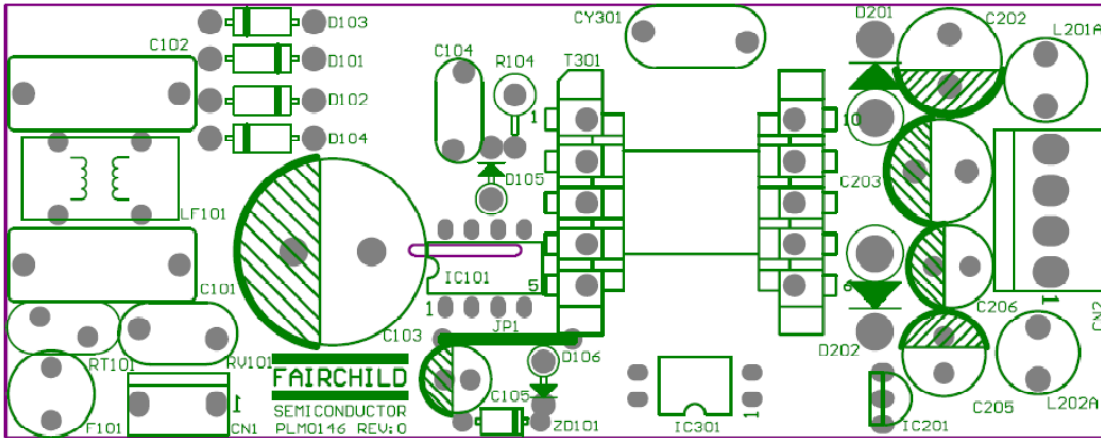


Figure 3. Top Overlay Silk Screen

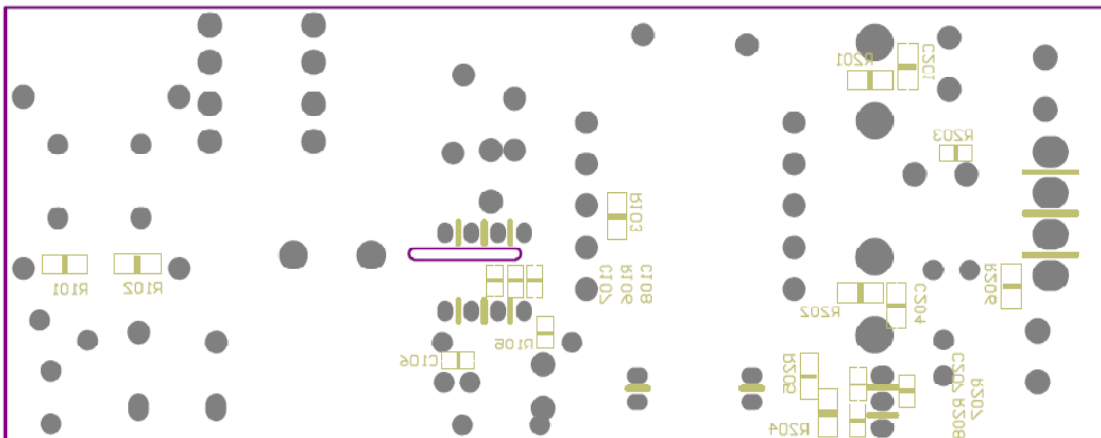


Figure 4. Bottom Overlay Silk Screen

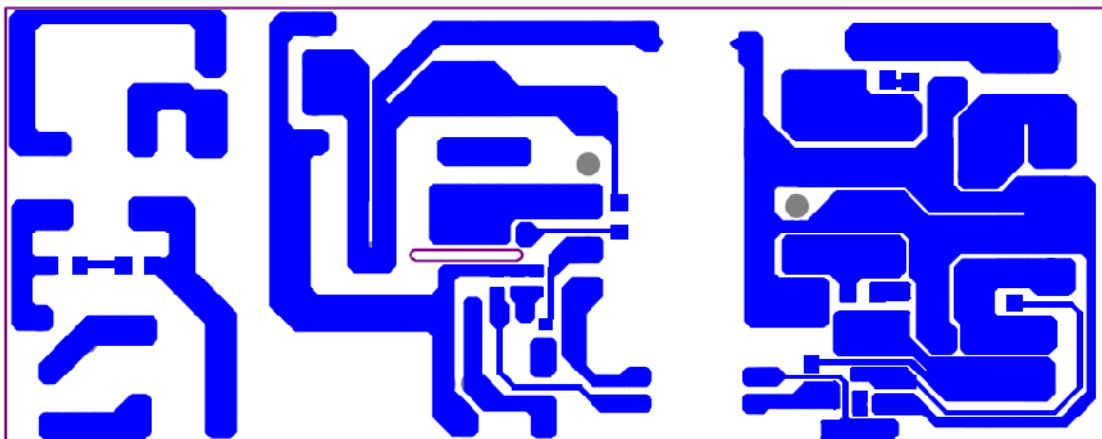


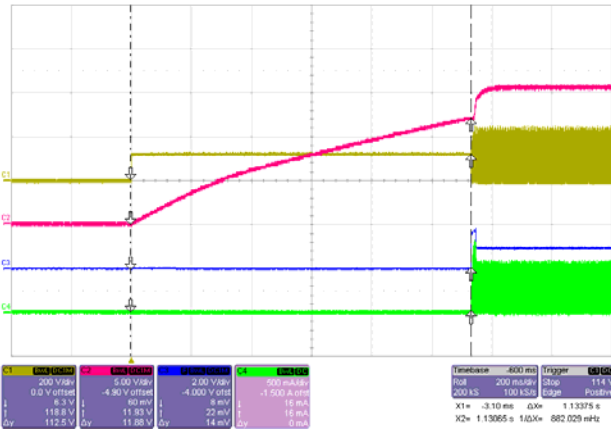
Figure 5. Bottom Layer Pattern

## 11. Test Conditions and Items

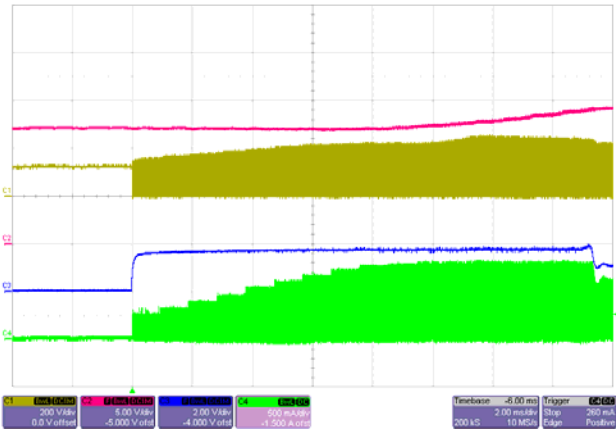
<b>Test Model</b>	FEBFSL126MR_H432v1
<b>Test Date</b>	4.29, 2011
<b>Test Temperature</b>	Ambient
<b>Test Equipment</b>	<b>AC Source:</b> 6800 AC POWER SOURCE <b>Electronic Load:</b> Chroma 63030 <b>Power Meter:</b> Yokogawa WT210 <b>Oscilloscope:</b> LeCory 24Xs-A
<b>Test Items</b>	<ol style="list-style-type: none"> <li>1. Startup performance</li> <li>2. Normal Operation</li> <li>3. Voltage Stress of Secondary Diodes and Drain</li> <li>4. Output Ripple &amp; Noise</li> <li>5. Short Protections</li> <li>6. Power Off Waveforms</li> <li>7. Efficiency</li> <li>8. Standby Power Consumption</li> <li>9. Output voltage regulation</li> <li>10. Temperature Measurement</li> <li>11. Conducted EMI Measurement</li> </ol>

## 11. Performance of Evaluation Board

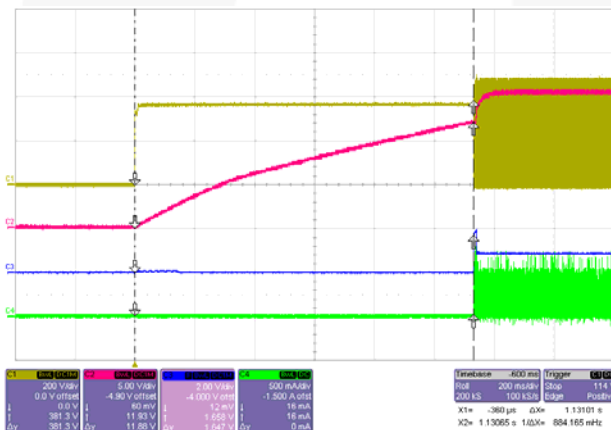
### 6.5. Startup Performance



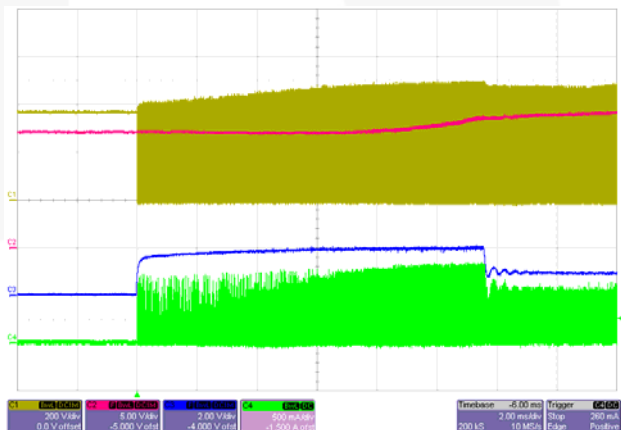
**Figure 6. Startup Time (AC Input to  $V_{CC}$  UVLO HIGH) = 1133.75ms, 90V<sub>AC</sub> and Full-Load Condition, CH1:  $V_{DS}$  (200V/div), CH2:  $V_{CC}$  (5V/div), CH3:  $V_{FB}$  (2V/div), CH4:  $I_{DS}$  (500mA/div), Time: 200ms/div**



**Figure 7. Soft-Start, 90V<sub>AC</sub> and Full-Load Condition, CH1:  $V_{DS}$  (200V/div), CH2:  $V_{CC}$  (5V/div), CH3:  $V_{FB}$  (2V/div), CH4:  $I_{DS}$  (500mA/div), Time: 2ms/div**



**Figure 8. Startup Time (AC Input to  $V_{CC}$  UVLO HIGH) = 1131.01ms, 265V<sub>AC</sub> and Full-Load Condition, CH1:  $V_{DS}$  (200V/div), CH2:  $V_{CC}$  (5V/div), CH3:  $V_{FB}$  (2V/div), CH4:  $I_{DS}$  (500mA/div), Time: 200ms/div**

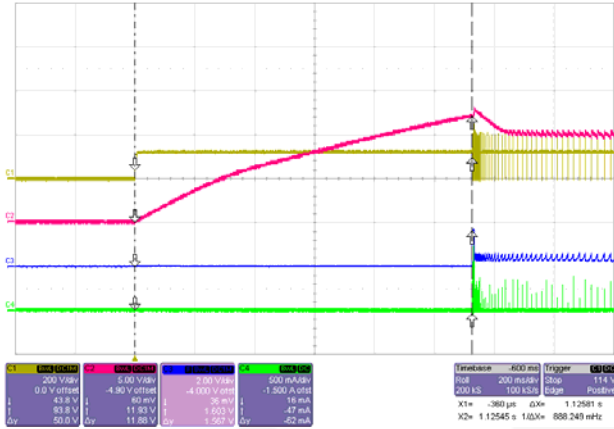


**Figure 9. Soft-Start, 265V<sub>AC</sub> and Full-Load Condition, CH1:  $V_{DS}$  (200V/div), CH2:  $V_{CC}$  (5V/div), CH3:  $V_{FB}$  (2V/div), CH4:  $I_{DS}$  (500mA/div), Time: 2ms/div**

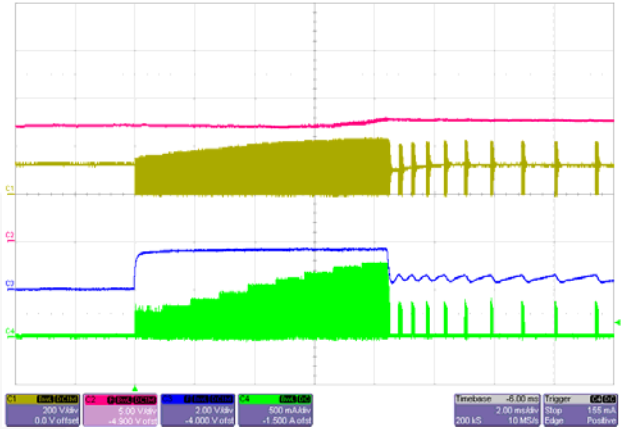
**Note:**

1. Startup time can be reduced with a smaller  $V_{CC}$  capacitor.

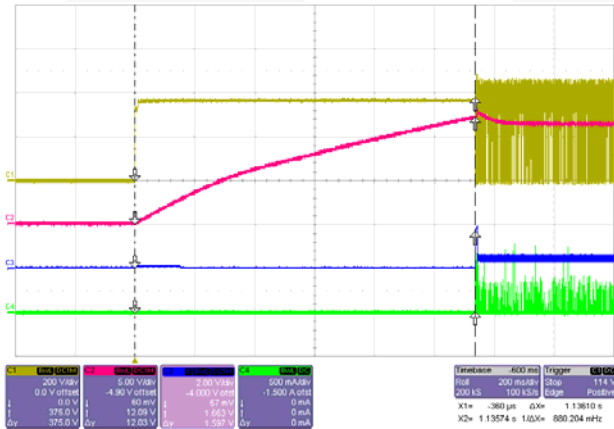




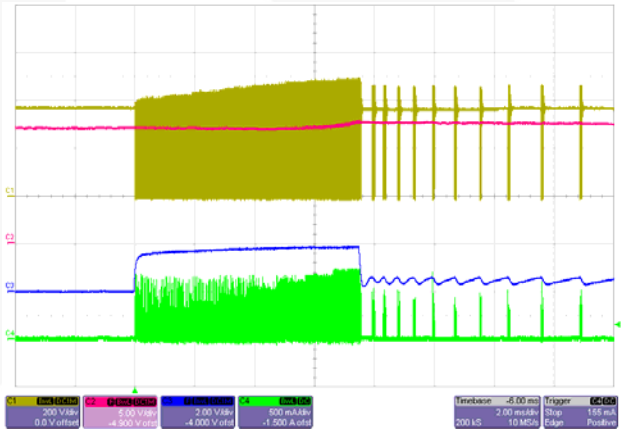
**Figure 10. Startup Time (AC Input to  $V_{CC}$  UVLO HIGH) = 1125.81ms, 90V<sub>AC</sub> and No-Load Condition, CH1:  $V_{DS}$  (200V/div), CH2:  $V_{CC}$  (5V/div), CH3:  $V_{FB}$  (2V/div), CH4:  $I_{DS}$  (500mA/div), Time: 200ms/div**



**Figure 11. Soft-Start, 90V<sub>AC</sub> and No-Load Condition, CH1:  $V_{DS}$  (200V/div), CH2:  $V_{CC}$  (5V/div), CH3:  $V_{FB}$  (2V/div), CH4:  $I_{DS}$  (500mA/div), Time: 2ms/div**



**Figure 12. Startup Time (AC Input to  $V_{CC}$  UVLO HIGH) = 1136.10ms, 265V<sub>AC</sub> and No-Load Condition, CH1:  $V_{DS}$  (200V/div), CH2:  $V_{CC}$  (5V/div), CH3:  $V_{FB}$  (2V/div), CH4:  $I_{DS}$  (500mA/div), Time: 200ms/div**

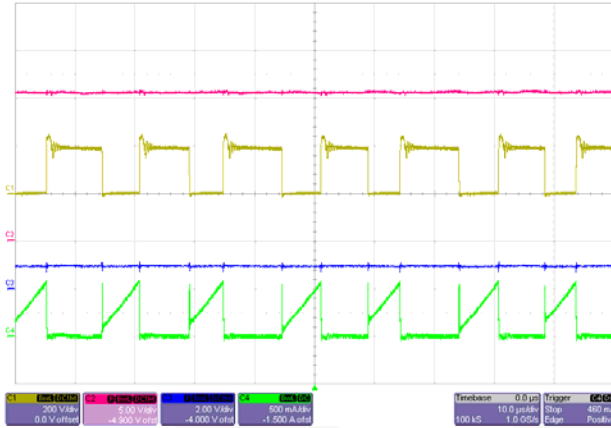


**Figure 13. Soft-Start, 265V<sub>AC</sub> and No-Load Condition, CH1:  $V_{DS}$  (200V/div), CH2:  $V_{CC}$  (5V/div), CH3:  $V_{FB}$  (2V/div), CH4:  $I_{DS}$  (500mA/div), Time: 2ms/div**

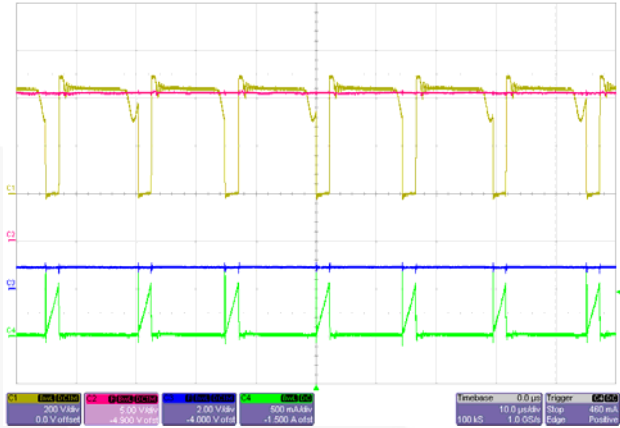
**Note:**

- Startup time can be reduced with a smaller  $V_{CC}$  capacitor.

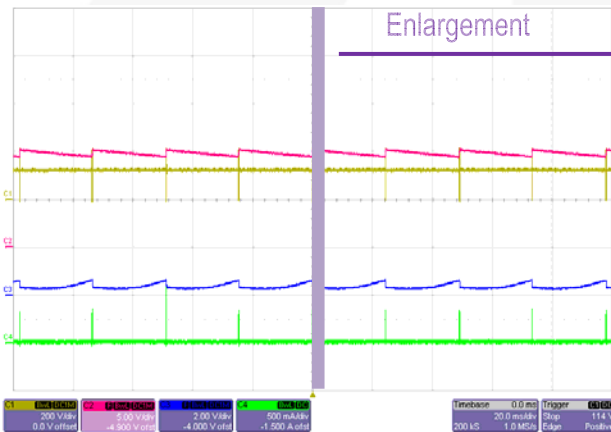
## 1.2. Normal Operation



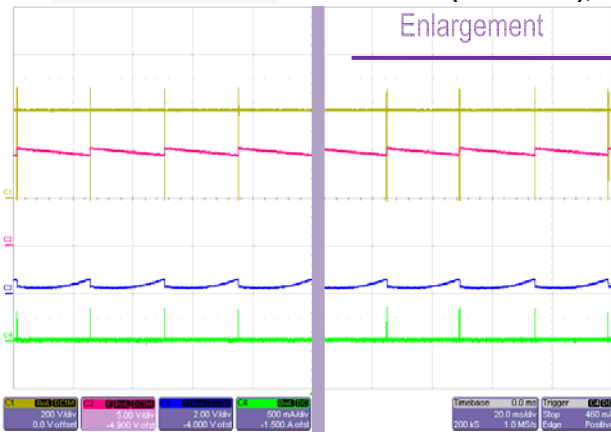
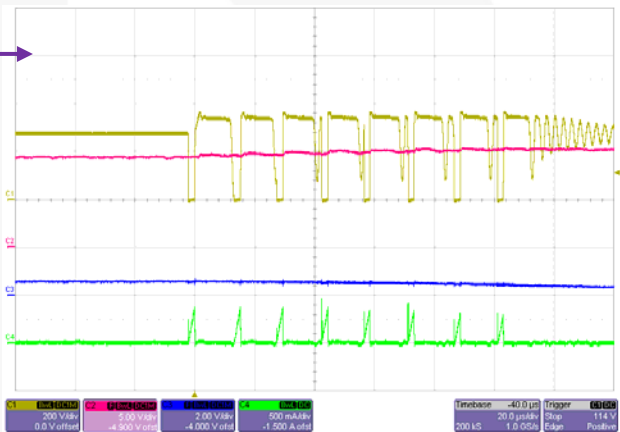
**Figure 14.** 90V<sub>AC</sub> and Full-Load Condition, CH1: V<sub>DS</sub> (200V/div), CH2: V<sub>CC</sub> (5V/div), CH3: V<sub>FB</sub> (2V/div), CH4: I<sub>DS</sub> (500mA/div), Time: 10µs/div



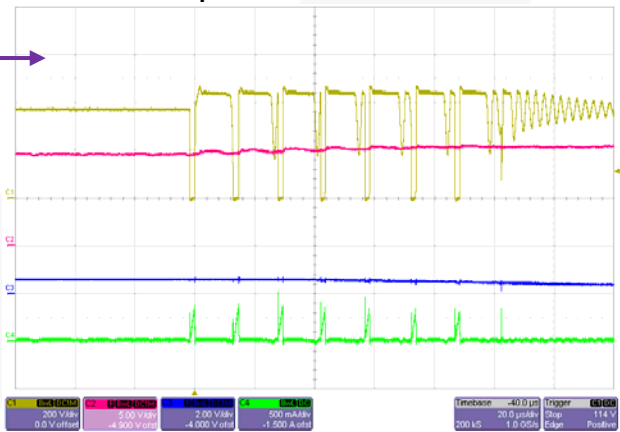
**Figure 15.** 265V<sub>AC</sub> and Full-Load Condition, CH1: V<sub>DS</sub> (200V/div), CH2: V<sub>CC</sub> (5V/div), CH3: V<sub>FB</sub> (2V/div), CH4: I<sub>DS</sub> (500mA/div), Time: 10µs/div



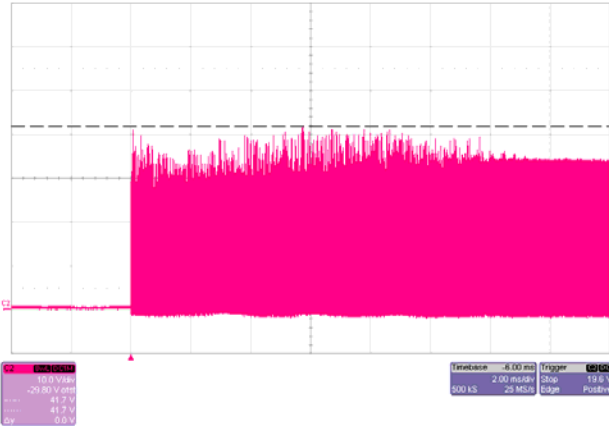
**Figure 16.** 90V<sub>AC</sub> and No-Load Condition, CH1: V<sub>DS</sub> (200V/div), CH2: V<sub>CC</sub> (5V/div), CH3: V<sub>FB</sub> (2V/div), CH4: I<sub>DS</sub> (500mA/div), Time: 20ms/div and 20µs/div



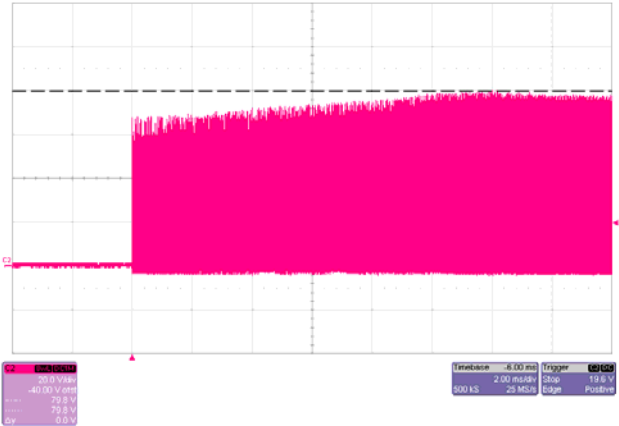
**Figure 17.** 265V<sub>AC</sub> and No-Load Condition, CH1: V<sub>DS</sub> (200V/div), CH2: V<sub>CC</sub> (5V/div), CH3: V<sub>FB</sub> (2V/div), CH4: I<sub>DS</sub> (500mA/div), Time: 20ms/div and 20µs/div



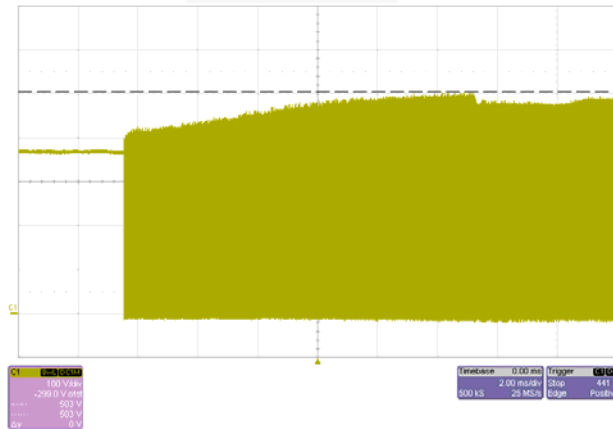
### 6.3. Voltage Stress of Secondary Diodes and Drain



**Figure 18. Second Diode Voltage, 5V Output Diode with 265V<sub>AC</sub> & Full-Load Condition, V<sub>DIODE.MAX</sub> at Startup = 41.7V, CH2: V<sub>DIODE</sub>, (10V/div) Time: 2ms/div**



**Figure 19. Second Diode Voltage, 12V Output Diode with 265V<sub>AC</sub> & Full-Load Condition, V<sub>DIODE.MAX</sub> at Startup = 79.8V, CH2: V<sub>DIODE</sub>, (20V/div) Time: 2ms/div**



**Figure 20. Drain Voltage with 265V<sub>AC</sub>, & Full-Load Condition, V<sub>DS.MAX</sub> at Startup = 503V, CH2: V<sub>DS</sub>, (100V/div), Time: 2ms/div**

## 1.4. Output Ripple and Noise

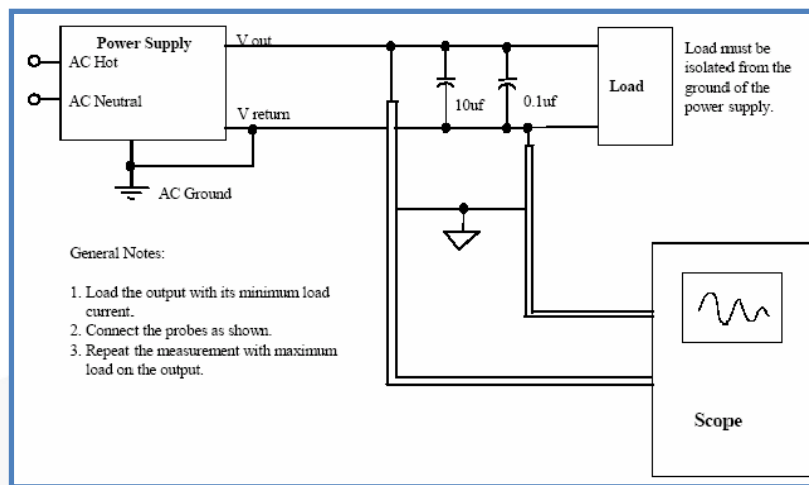
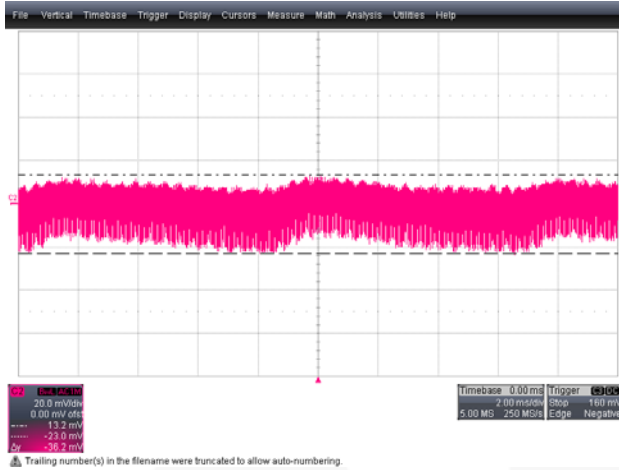


Figure 21. Recommended Test Setup

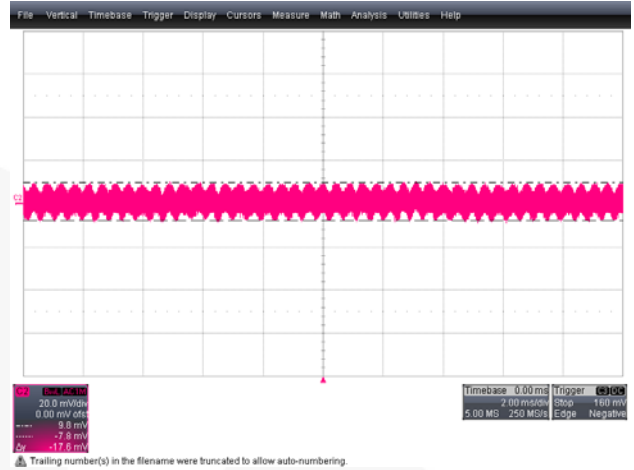
Table 1. Output Ripple and Noise Table

	90V <sub>AC</sub>		110V <sub>AC</sub>		230V <sub>AC</sub>		265V <sub>AC</sub>	
	5V Output	12V Output	5V Output	12V Output	5V Output	12V Output	5V Output	12V Output
<b>100% Load</b>	37mV	70mV	29mV	49mV	20mV	35mV	18mV	33mV
<b>75% Load</b>	24mV	40mV	17mV	27mV	15mV	26mV	16mV	27mV
<b>50% Load</b>	13mV	20mV	14mV	21mV	14mV	20mV	13mV	20mV
<b>25% Load</b>	73mV	55mV	70mV	55mV	71mV	55mV	72mV	57mV
<b>No-Load</b>	28mV	10mV	28mV	11mV	28mV	10mV	33mV	10mV

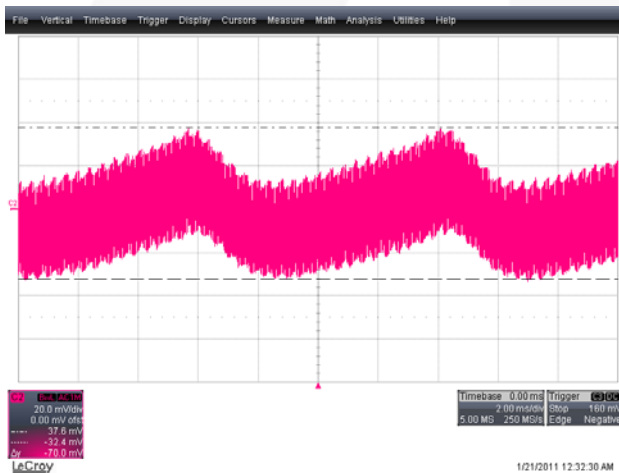
## 6.5. Ripple and Noise Waveforms



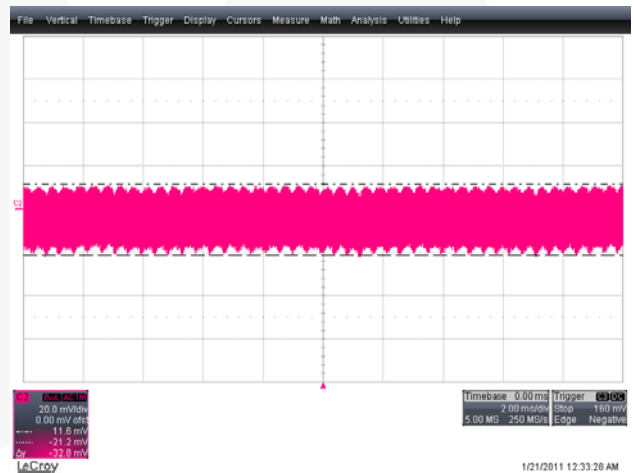
**Figure 22.**  $V_{O\_RIPPLE} = 37\text{mV}$ , 5V Output at 90V<sub>AC</sub> and Full-Load Condition, CH2: V<sub>O</sub> (20mV/div), Time: 2ms/div



**Figure 23.**  $V_{O\_RIPPLE} = 18\text{mV}$ , 5V Output at 265V<sub>AC</sub> and Full-Load Condition, CH2: V<sub>O</sub> (20mV/div), Time: 2ms/div



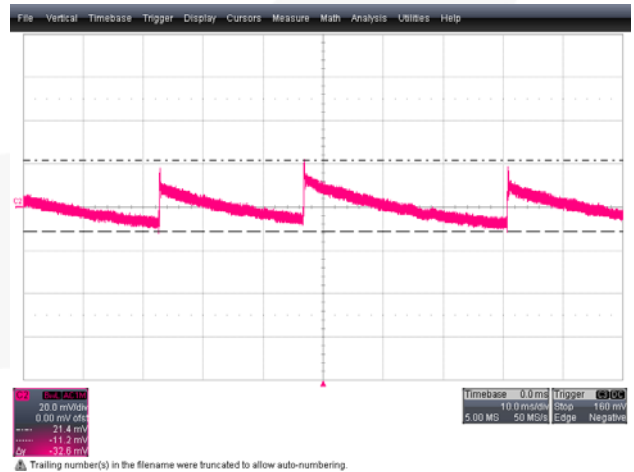
**Figure 24.**  $V_{O\_RIPPLE} = 70\text{mV}$ , 12V Output at 90V<sub>AC</sub> and Full-Load Condition, CH2: V<sub>O</sub> (20mV/div), Time: 10ms/div



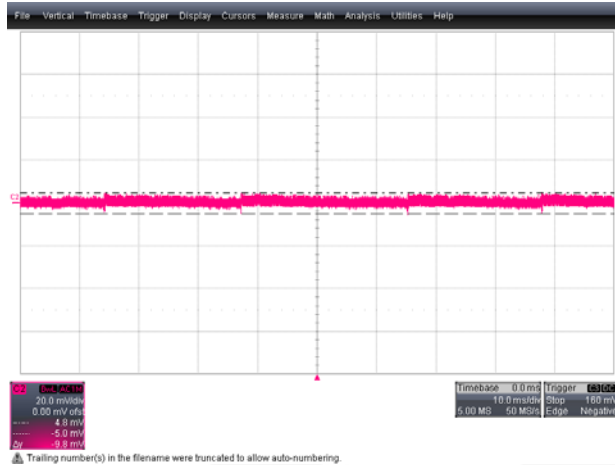
**Figure 25.**  $V_{O\_RIPPLE} = 33\text{mV}$ , 12V Output at 265V<sub>AC</sub> and Full-Load Condition, CH2: V<sub>O</sub> (20mV/div), Time: 2ms/div



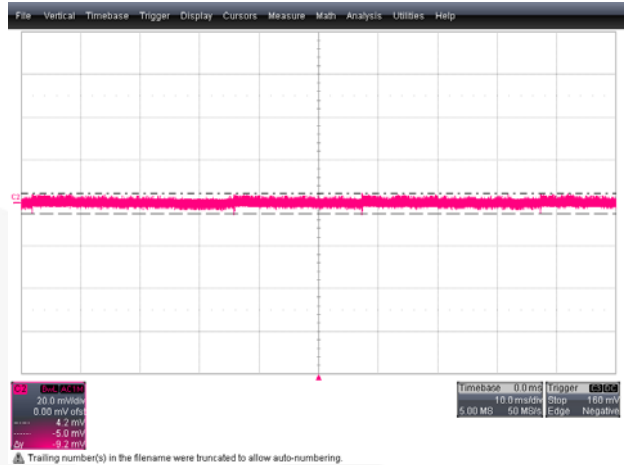
**Figure 26.**  $V_{O\_RIPPLE} = 28\text{mV}$ , 5V Output at 90V<sub>AC</sub> and No-Load Condition, CH2: V<sub>O</sub> (20mV/div), Time: 10ms/div



**Figure 27.**  $V_{O\_RIPPLE} = 33\text{mV}$ , 5V Output at 90V<sub>AC</sub> and No-Load Condition, CH2: V<sub>O</sub> (20mV/div), Time: 10ms/div



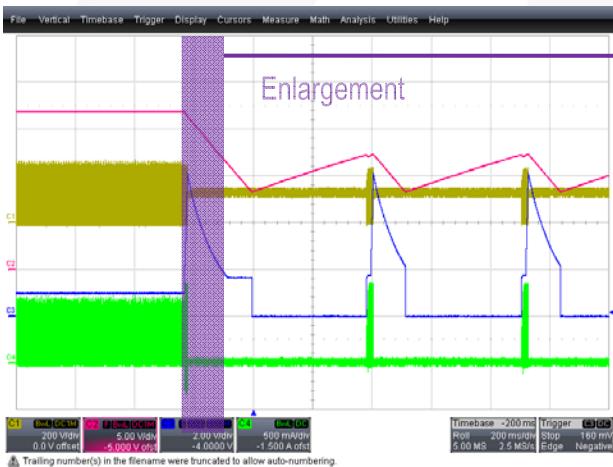
**Figure 28.**  $V_{O\_RIPPLE} = 10\text{mV}$ , 12V Output at 90V<sub>AC</sub> and No-Load Condition, CH2:  $V_O$  (20mV/div), Time: 10ms/div



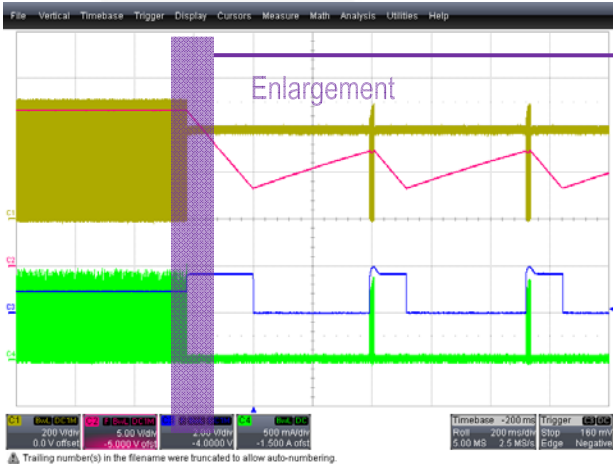
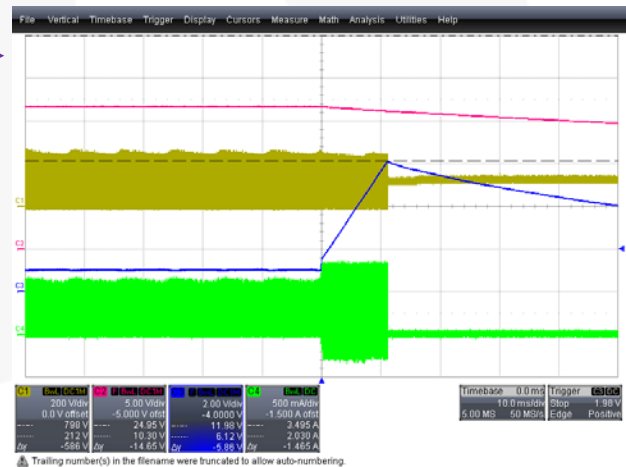
**Figure 29.**  $V_{O\_RIPPLE} = 10\text{mV}$ , 12V Output at 265V<sub>AC</sub> and No-Load Condition, CH2:  $V_O$  (20mV/div), Time: 10ms/div

## 6.6. Short Protections

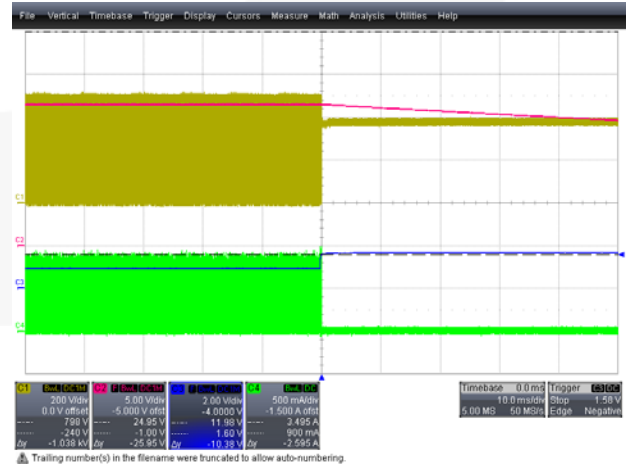
### 6.6.1. Output Short

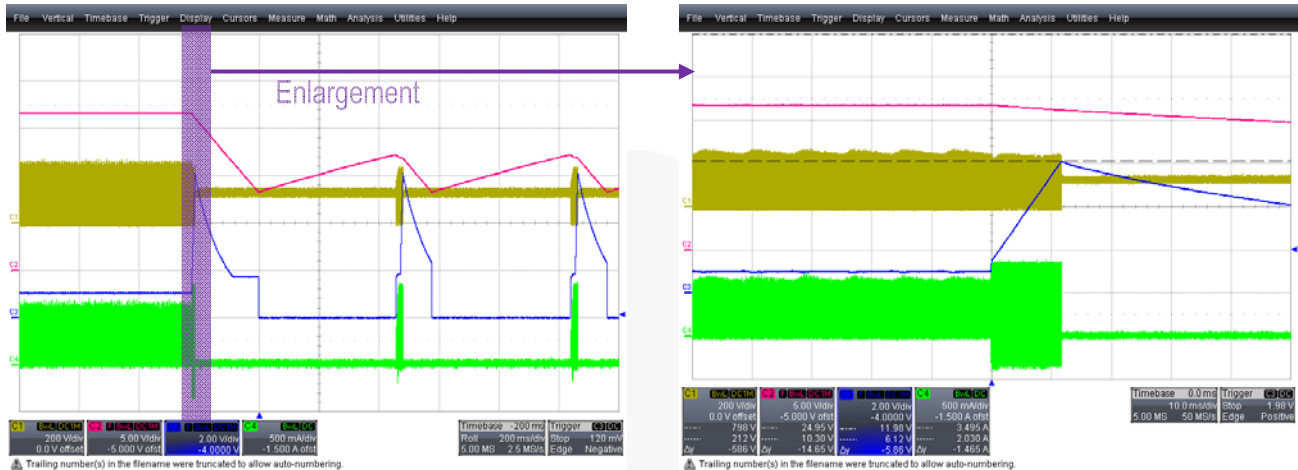


**Figure 30.** OLP Triggered:  $V_{FB} = 6.12\text{V}$ , 5V Output Short with 90V<sub>AC</sub> and Full-Load, CH1:  $V_{DS}$  (200V/div), CH2:  $V_{CC}$  (5V/div), CH3:  $V_{FB}$  (2V/div), CH4:  $I_{DS}$  (500mA/div), Time: 200ms/div and 10ms/div

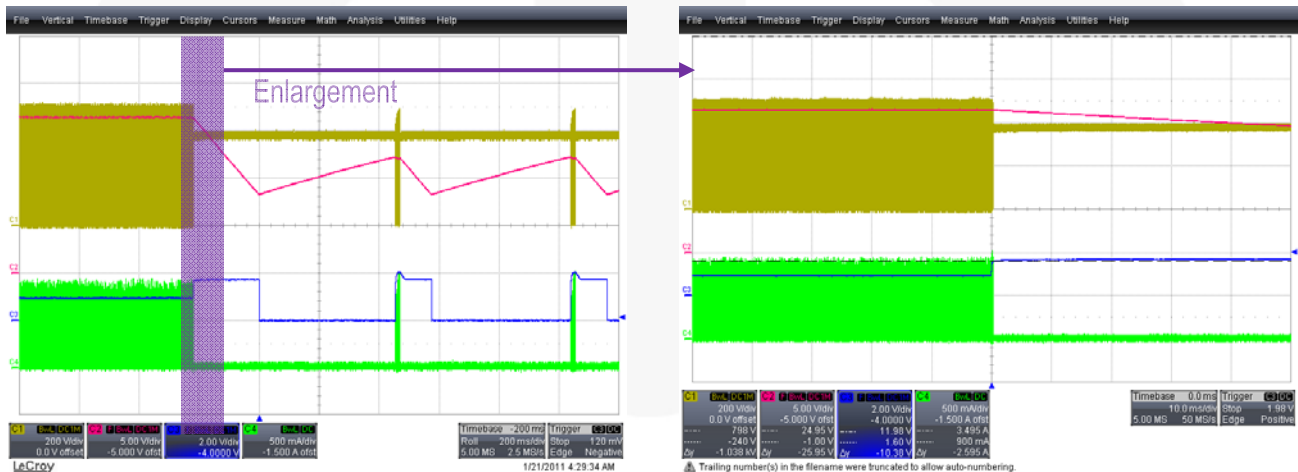


**Figure 31.** OSP Triggered:  $V_{FB} = 1.60\text{V}$ , 5V Output Short with 265V<sub>AC</sub> and Full-Load, CH1:  $V_{DS}$  (200V/div), CH2:  $V_{CC}$  (5V/div), CH3:  $V_{FB}$  (2V/div), CH4:  $I_{DS}$  (500mA/div), Time: 200ms/div and 10ms/div





**Figure 32.** OLP Triggered :  $V_{FB} = 6.12V$ , 12V Output Short with 90V<sub>AC</sub> and Full-Load, CH1:  $V_{DS}$  (200V/div), CH2:  $V_{CC}$  (5V/div), CH3:  $V_{FB}$  (2V/div), CH4:  $I_{DS}$  (500mA/div), Time: 200ms/div and 10ms/div



**Figure 33.** OSP Triggered:  $V_{FB} = 1.60V$ , 12V Output Short with 265V<sub>AC</sub> and Full-Load, CH1:  $V_{DS}$  (200V/div), CH2:  $V_{CC}$  (5V/div), CH3:  $V_{FB}$  (2V/div), CH4:  $I_{DS}$  (500mA/div), Time: 200ms/div and 10ms/div



### 6.6.2. Second Diode Short



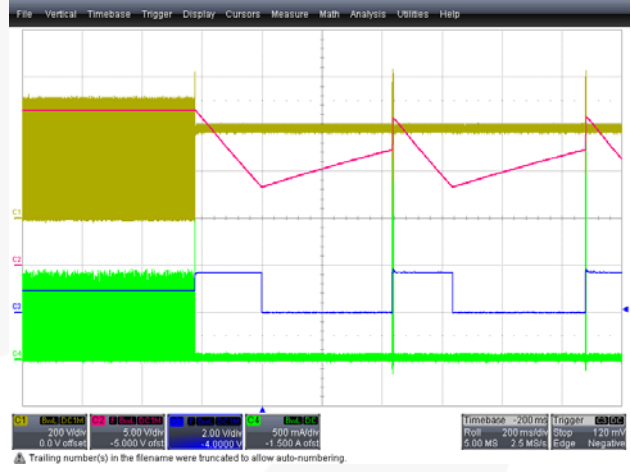
**Figure 34. 5V Diode Short at 90V<sub>AC</sub> and Full Load Condition, CH1: V<sub>DS</sub> (200V/div), CH2: V<sub>CC</sub> (5V/div), CH3: V<sub>FB</sub> (2V/div), CH4: I<sub>DS</sub> (500mA/div), Time: 200ms/div**



**Figure 35. 5V Diode Short at 265V<sub>AC</sub> and Full Load Condition, CH1: V<sub>DS</sub> (200V/div), CH2: V<sub>CC</sub> (5V/div), CH3: V<sub>FB</sub> (2V/div), CH4: I<sub>DS</sub> (500mA/div), Time: 200ms/div**



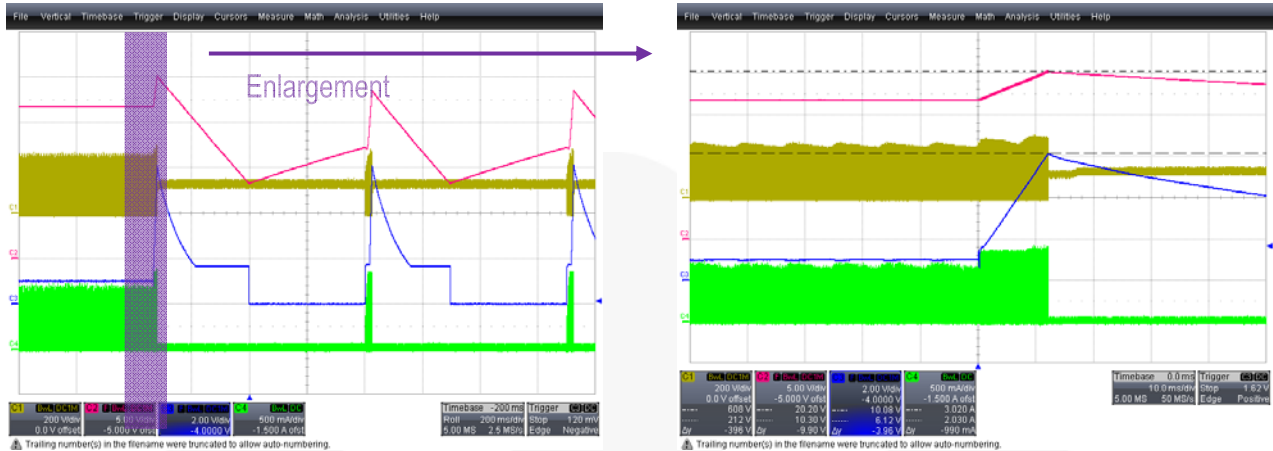
**Figure 36. 5V Diode Short at 90V<sub>AC</sub> and Full Load Condition, CH1: V<sub>DS</sub> (200V/div), CH2: V<sub>CC</sub> (5V/div), CH3: V<sub>FB</sub> (2V/div), CH4: I<sub>DS</sub> (500mA/div), Time: 200ms/div**



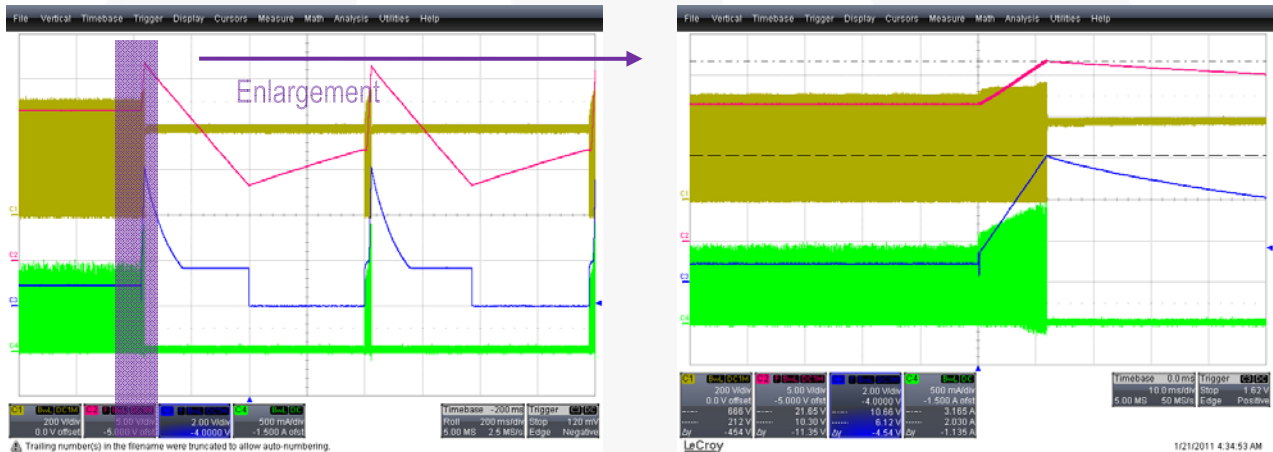
**Figure 37. 5V Output at 265V<sub>AC</sub> and Full Load Condition, CH1: V<sub>DS</sub> (200V/div), CH2: V<sub>CC</sub> (5V/div), CH3: V<sub>FB</sub> (2V/div), CH4: I<sub>DS</sub> (500mA/div), Time: 200ms/div**



### 6.6.2. Opto-Coupler Secondary Short

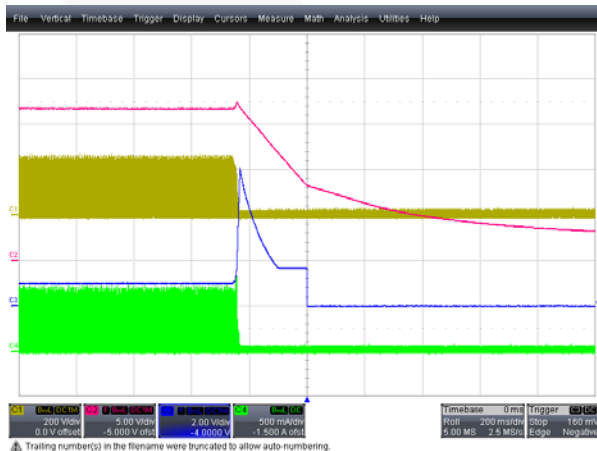


**Figure 38. OLP Triggered:  $V_{FB} = 6.12V$ , Opto-coupler Secondary Short with 90V<sub>AC</sub> and Full-Load, CH1:  $V_{DS}$  (200V/div), CH2:  $V_{CC}$  (5V/div), CH3:  $V_{FB}$  (2V/div), CH4:  $I_{DS}$  (500mA/div), Time: 200ms/div and 10ms/div**



**Figure 39. OLP Triggered:  $V_{FB} = 6.12V$ , Opto-coupler Secondary with 265V<sub>AC</sub> and Full-Load, CH1:  $V_{DS}$  (200V/div), CH2:  $V_{CC}$  (5V/div), CH3:  $V_{FB}$  (2V/div), CH4:  $I_{DS}$  (500mA/div), Time: 200ms/div and 10ms/div**

### 6.6.3. Power-Off Waveforms



**Figure 40. Power Off at 90V<sub>AC</sub> and Full Load Condition, CH1:  $V_{DS}$  (200V/div), CH2:  $V_{CC}$  (5V/div), CH3:  $V_{FB}$  (2V/div), CH4:  $I_{DS}$  (500mA/div), Time: 200ms/div**



**Figure 41. Power Off at 265V<sub>AC</sub> and Full Load Condition, CH1:  $V_{DS}$  (200V/div), CH2:  $V_{CC}$  (5V/div), CH3:  $V_{FB}$  (2V/div), CH4:  $I_{DS}$  (500mA/div), Time: 200ms/div**

## 6.7. Efficiency

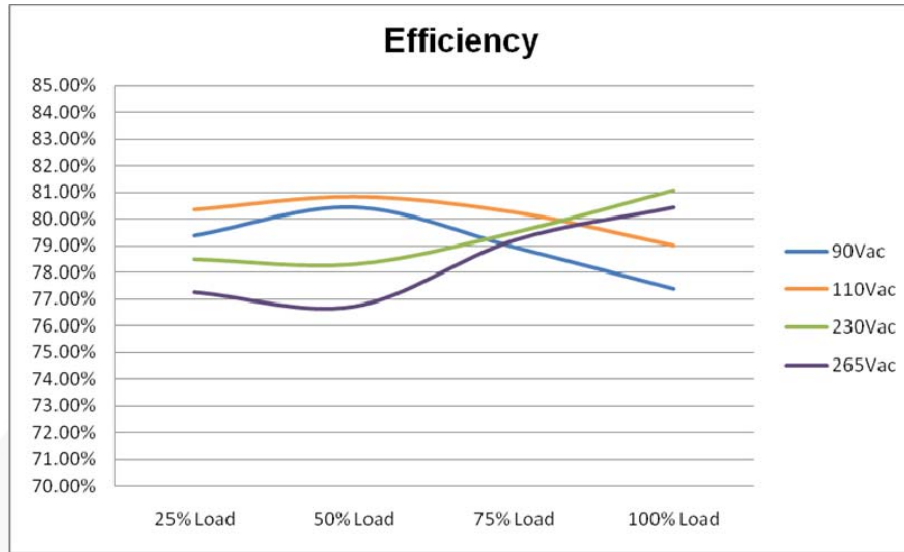


Figure 42. Efficiency vs. Load

Table 2. Efficiency Test Results

		90V <sub>AC</sub>		110V <sub>AC</sub>		230V <sub>AC</sub>		265V <sub>AC</sub>	
		V <sub>O</sub>	I <sub>O</sub>	V <sub>O</sub>	I <sub>O</sub>	V <sub>O</sub>	I <sub>O</sub>	V <sub>O</sub>	I <sub>O</sub>
100% Load	5V Output	4.998V	1.800A	4.998V	1.800A	4.999V	1.800A	4.999V	1.800A
	12V Output	11.567V	0.400A	11.540V	0.400A	11.525V	0.400A	11.525V	0.400A
	Input Power	17.60W		17.23W		16.78W		16.92W	
	Efficiency	77.40%		79.00%		81.10%		80.43%	
75% Load	5V Output	4.999V	1.350A	4.999V	1.350A	4.999V	1.350A	4.999V	1.350A
	12V Output	11.460V	0.300A	11.453V	0.300A	11.452V	0.300A	11.450V	0.300A
	Input Power	12.90W		12.69W		12.81W		12.86W	
	Efficiency	78.97%		80.26%		79.50%		79.19%	
50% Load	5V Output	5.000V	0.900A	5.000V	0.900A	5.000V	0.900A	5.000V	0.900A
	12V Output	11.371V	0.200A	11.371V	0.200A	11.370V	0.200A	11.370V	0.200A
	Input Power	8.42W		8.38W		8.65W		8.83W	
	Efficiency	80.45%		80.84%		78.31%		76.72%	
25% Load	5V Output	5.000V	0.450A	5.000V	0.450A	5.000V	0.450A	5.000V	0.450A
	12V Output	11.480V	0.100A	11.490V	0.100A	11.490V	0.100A	11.490V	0.100A
	Input Power	4.28W		4.23W		4.33W		4.40W	
	Efficiency	79.39%		80.35%		78.50%		77.25%	
<b>Average Efficiency</b>		79.05%		80.11%		79.35%		78.40%	

**Note:**

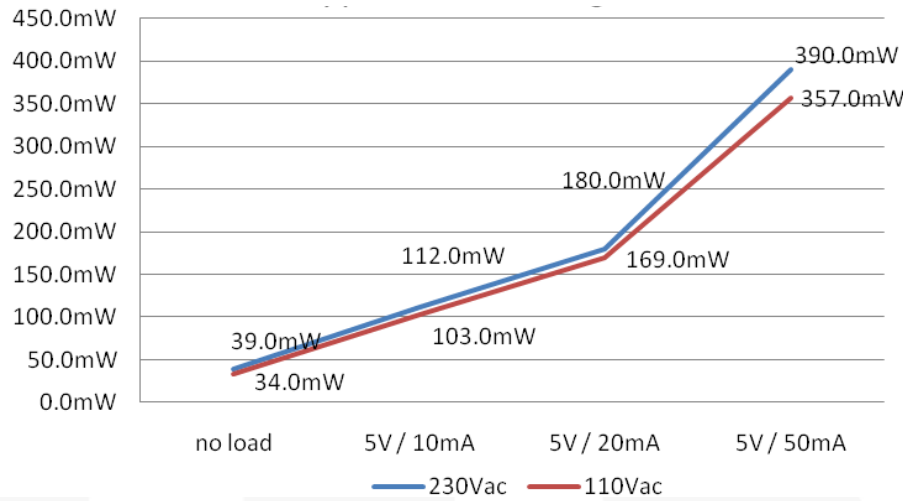
3. Above test was completed after 15 minutes aging.

**Table 3. Standby Power Consumption**

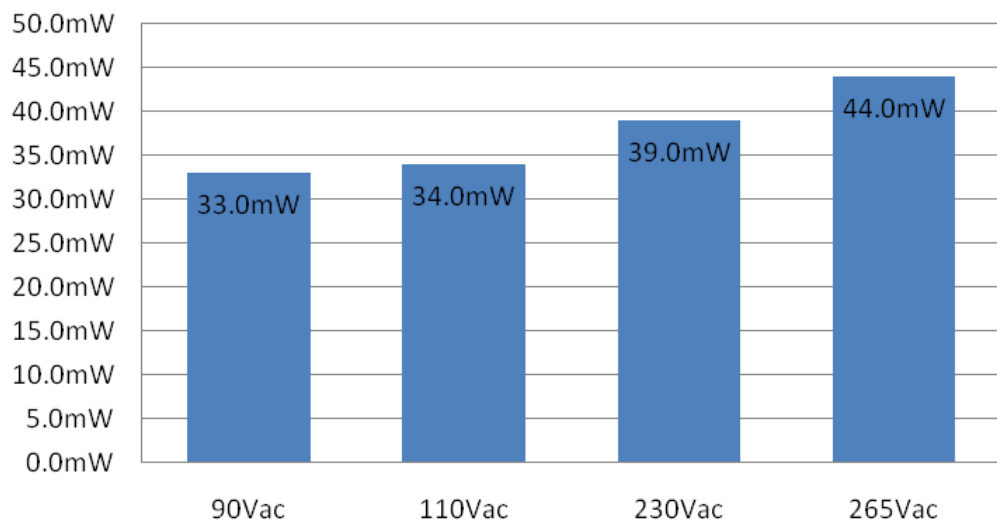
		90V <sub>AC</sub>		110V <sub>AC</sub>		230V <sub>AC</sub>		265V <sub>AC</sub>	
		V <sub>o</sub>	I <sub>o</sub>	V <sub>o</sub>	I <sub>o</sub>	V <sub>o</sub>	I <sub>o</sub>	V <sub>o</sub>	I <sub>o</sub>
<b>50mA</b>	<b>5V Output</b>	5.002V	50.6mA	5.002V	50.6mA	5.001V	50.6mA	5.001V	50.6mA
	<b>12V Output</b>	12.290V	0.0mA	12.300V	0.0mA	12.380V	0.0mA	12.420V	0.0mA
	<b>Input Power</b>	355.0mW		357.0mW		390.0mW		403.0mW	
<b>20mA</b>	<b>5V Output</b>	5.002V	20.6mA	5.002V	20.6mA	5.002V	20.6mA	5.002V	20.6mA
	<b>12V output</b>	12.120V	0.0mA	12.130V	0.0mA	12.210V	0.0mA	12.220V	0.0mA
	<b>Input Power</b>	168.0mW		169.0mW		180.0mW		191.0mW	
<b>10mA</b>	<b>5V Output</b>	5.002V	10.1mA	5.002V	10.1mA	5.002V	10.1mA	5.002V	10.1mA
	<b>12V Output</b>	12.010V	0.0mA	12.020V	0.0mA	12.050V	0.0mA	12.080V	0.0mA
	<b>Input Power</b>	104.0mW		103.0mW		112.0mW		117.0mW	
<b>0mA</b>	<b>5V Output</b>	5.002V	0.0mA	5.002V	0.0mA	5.002V	0.0mA	5.002V	0.0mA
	<b>12V Output</b>	11.600V	0.0mA	11.610V	0.0mA	11.610V	0.0mA	11.610V	0.0mA
	<b>Input Power</b>	33.0mW		34.0mW		39.0mW		44.0mW	

**Note:**

- Above test results represent changing 5V load condition with no-load condition of 12V output.



**Figure 43. Standby Power as Decreasing Load**



**Figure 44. No Load Standby Power**

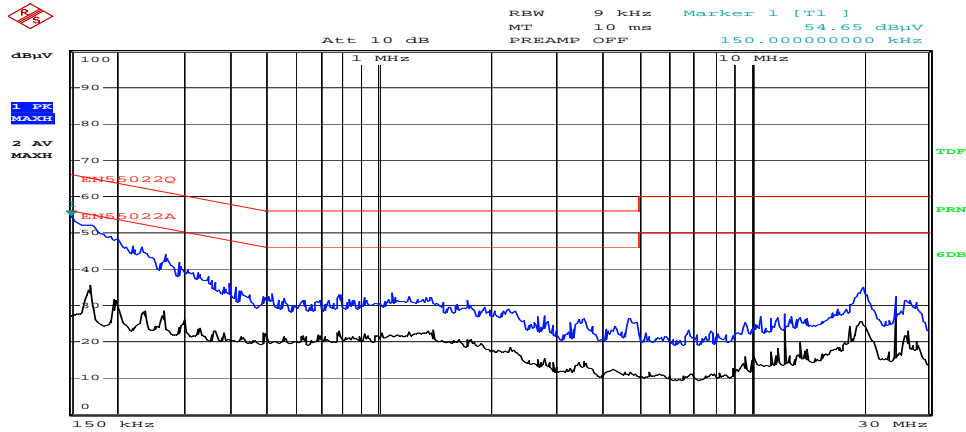
## 6.9. Output Voltage Regulation

Output Regulation Table									
		No Load	5V/10mA	5V/20mA	5V/50mA	25% Load	50% Load	75% Load	100% Load
5V	90V <sub>AC</sub>	0.04%	0.04%	0.04%	0.04%	0.00%	0.00%	-0.02%	-0.04%
	110V <sub>AC</sub>	0.04%	0.04%	0.04%	0.04%	0.00%	0.00%	-0.02%	-0.04%
	230V <sub>AC</sub>	0.04%	0.04%	0.04%	0.02%	0.00%	0.00%	-0.02%	-0.02%
	265V <sub>AC</sub>	0.04%	0.04%	0.04%	0.02%	0.00%	0.00%	-0.02%	-0.02%
12V	90V <sub>AC</sub>	-3.33%	0.08%	1.00%	2.42%	-4.33%	-5.24%	-4.50%	-3.61%
	110V <sub>AC</sub>	-3.25%	0.17%	1.08%	2.50%	-4.25%	-5.24%	-4.56%	-3.83%
	230V <sub>AC</sub>	-3.25%	0.42%	1.75%	3.17%	-4.25%	-5.25%	-4.57%	-3.96%
	265V <sub>AC</sub>	-3.25%	0.67%	1.83%	3.50%	-4.25%	-5.25%	-4.58%	-3.96%

## 6.10. IC Temperature Measurement

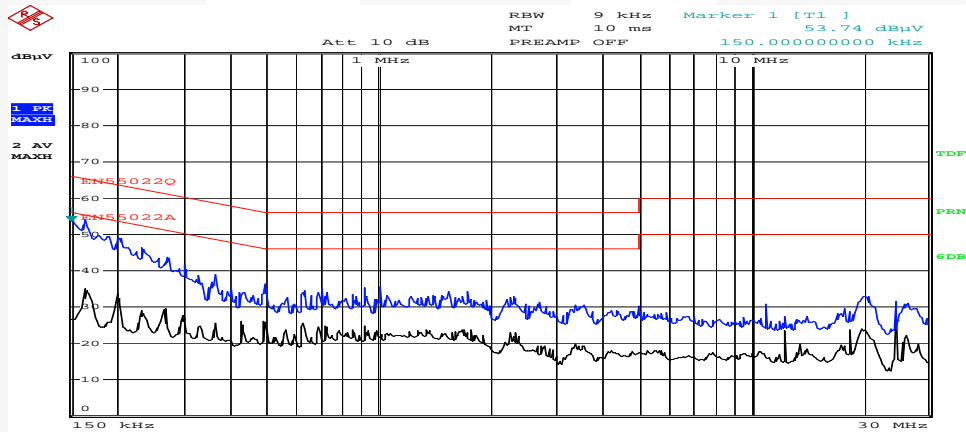
	90V <sub>AC</sub>	110V <sub>AC</sub>	230V <sub>AC</sub>	265V <sub>AC</sub>
<b>IC</b>	77.4°C	73.2°C	72.0°C	76.0°C
<b>Transformer</b>	59.0°C	59.9°C	62.0°C	62.6°C
<b>5V Output Diode</b>	87.2°C	86.7°C	86.9°C	87.0°C
<b>12V Output Diode</b>	56.4°C	56.5°C	57.0°C	57.0°C
<b>Ambient</b>	30.0°C	29.1°C	29.2°C	29.0°C

## 6.11. Conducted EMI Measurements



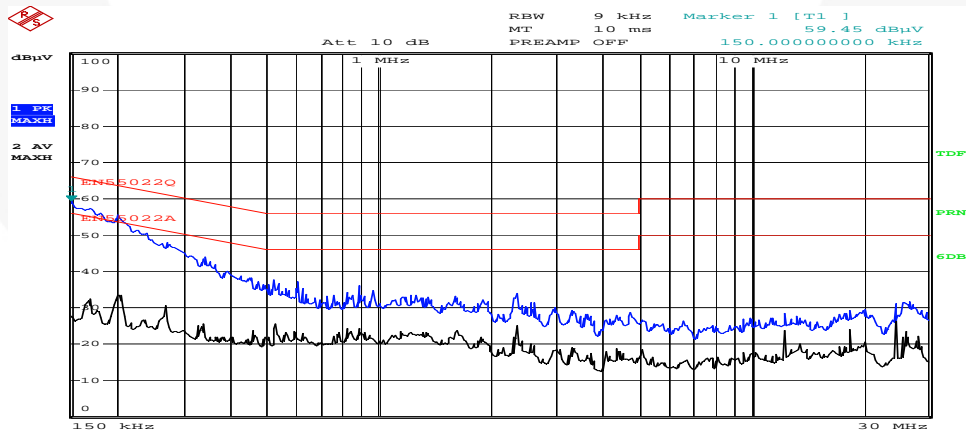
Date: 21.JAN.2011 17:45:41

**Figure 45.** <L1>,  $V_{IN} = 110V_{AC}$ , Load = 5V / 2.5Ω, Load = 12V / 28Ω



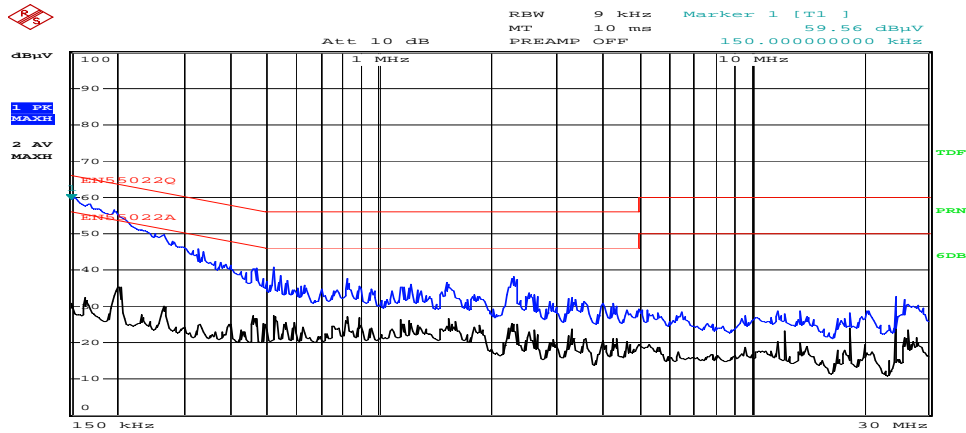
Date: 21.JAN.2011 17:43:54

**Figure 46.** <N>,  $V_{IN} = 110V_{AC}$ , Load = 5V / 2.5Ω, Load = 12V / 28Ω



Date: 21.JAN.2011 17:40:22

**Figure 47.** <L1>,  $V_{IN} = 230V_{AC}$ , Load = 5V / 2.5Ω, Load = 12V / 28Ω



Date: 21.JAN.2011 17:42:09

Figure 48. <N>,  $V_{IN} = 230V_{AC}$ , Load = 5V / 2.5Ω, Load = 12V / 28Ω

## 11. Schematic

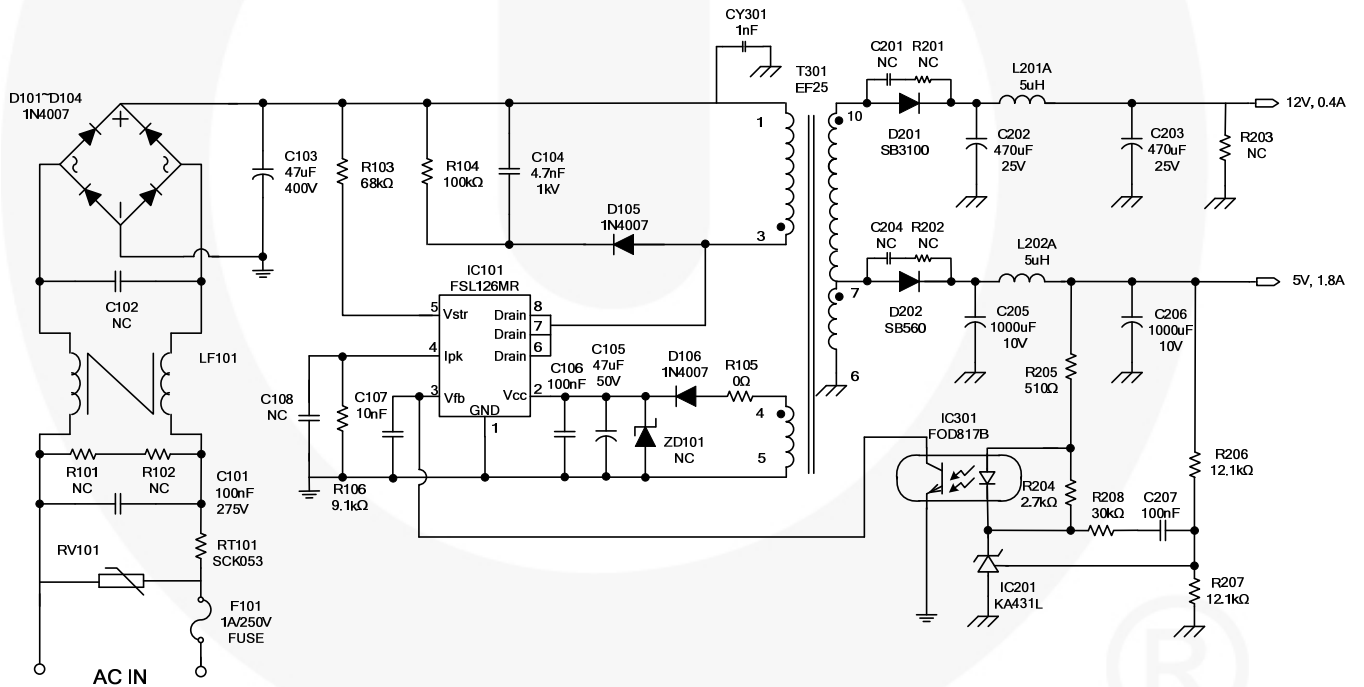


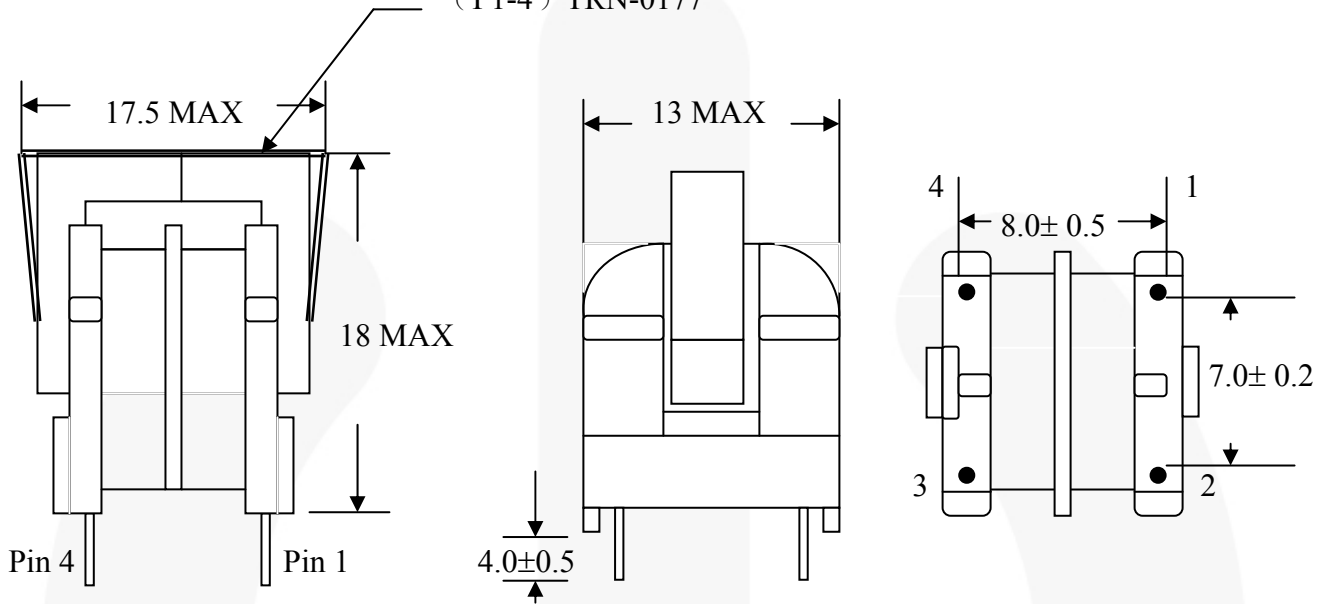
Figure 49. Schematic

## 8. Line Filter and Inductor Specification

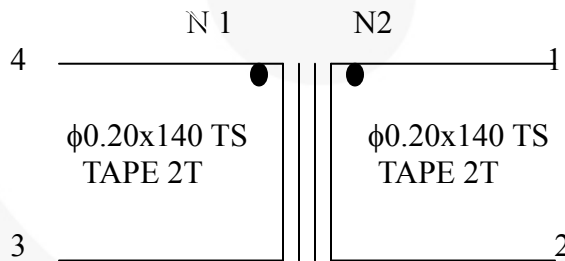
Customer				P/N:	TRN-0177
ATE	12/22/2003	Version	A	Page	1/2

### 1. DIMENSION

(P1-4) TRN-0177



### 2. SCHEMATIC



**Note :**

1. The inductance (winding) of N1 and N2 must be same, tolerance  $\pm 2\%$  .
2. The initial inductance of N1 and N2 must be : 50mH  $\pm 20$

UNIT	m/m	DRAWN	CHECK	TITLE	LINE FILTER
TEL	(02)29450588	Ci wun Chen	Guo long Huang	IDENT NO.	TRN-0177
FAX	(02)29447647	SEN HUEI INDUSTRIAL CO., LTD.		D W G NO.	I0903
No.26-1, Lane 128, Sec. 2, Singnan Rd., Jhonghe City, Taipei County 235, Taiwan (R.O.C.)					



Customer				P/N:	TRN-0177
DATE	12/22/2003	Version	A	Page	2/2

### 3. ELECTRICAL SPECIFICATION

3.1 Inductance test: at 1KHz ,1V

L1: 50mH  $\pm$  20% . L2 : 50mH  $\pm$ 20% .

3.2 DC Resistance test at 25°C

R1: 2.3 mOhmo max. R2 : 2.3 mOhmo max.

3.3 Hi-pot test :

AC 1000V /5mA/1s hi-pot for one minute between N1to N2.

AC 1000V /5mA/1s hi-pot for one minute between N1 & N2 to core.

3.4 Insulation test :

The insulation resistance is between winding to winding and winding to core measured by DC 500V, must be over 100Mohm.

3.5 Terminal strength :

1.0Kg on terminals for 30 seconds, test the breakdown.

### 4. MATERIALS LIST

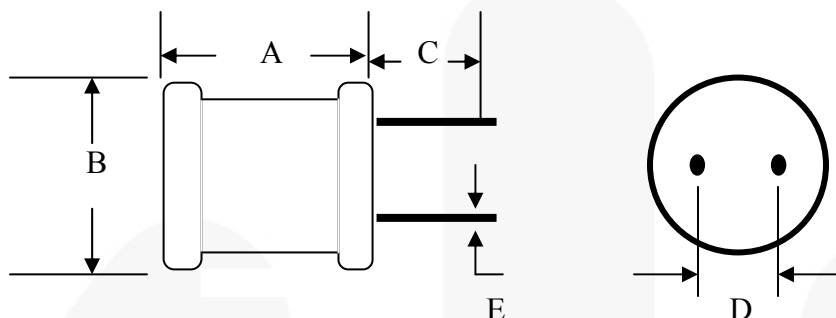
COMPONENT	MAT'L	MANUFACTURE	UL FILE NO.
1BOBBIN	T373J, 94V-0	Chang Chun plastics CO.,LTD, TF-UU9.8	E59481(S)
2.CORE	A10, MJ	Ferrite core UU9.8. Acme, Chilsin,.	
3.WIRE	UEW-2	Jung Shing Wire CO.,LTD	E79029(S)
	UEW	Tai-I electric Wire & Cable CO.,LTD	E85640(S)
4.VARNISH	BC-346A	John C Dolph CO.,LTD	E51047(M)
	468-2FC	Ripley Resin Engineering Co Inc.	E81777(N)
5.TAPE	1350	Minnesota Mining & MFG co	E17385(N)
	3161	Nitto Denko CORP.	E34833(M)
6.TERMINALS	Tin-Coated-Copper Wire	Will for special wire CORP.	
7.CLAMP	UU9.8	Pin Hsiang industrial CO.,LTD	

UNIT	m/m	DRAWN	CHECK	TITLE	LINE FILTER
TEL	(02)29450588	Ci wun Chen	Guo long Huang	IDENT NO.	TRN-0177
FAX	(02)29447647	SEN HUEI INDUSTRIAL CO., LTD.		D W G NO.	I0903
No.26-1, Lane 128, Sec. 2, Singnan Rd., Jhonghe City, Taipei County 235, Taiwan (R.O.C.)					

Customer				P/N:	TRN-0216
DATE	05/22/2007	Version	A	Page	1/1

**1.DIMENSION:**

**UNIT: mm**



A	11 max
B	9.0 max
C	10 (REF)
D	3.0±1
E	φ0.65

**2.ELECTRICAL SPECIFICATION: at 1KHz,0.3V**

- 2.1 INDUCTANCE : 5μH min
- 2.2 DC RESISTANCE : 28.mOhm max
- 2.3 TURN & WIRE : φ0.55x16.5TS(ref)

**3. MATERIALS LIST**

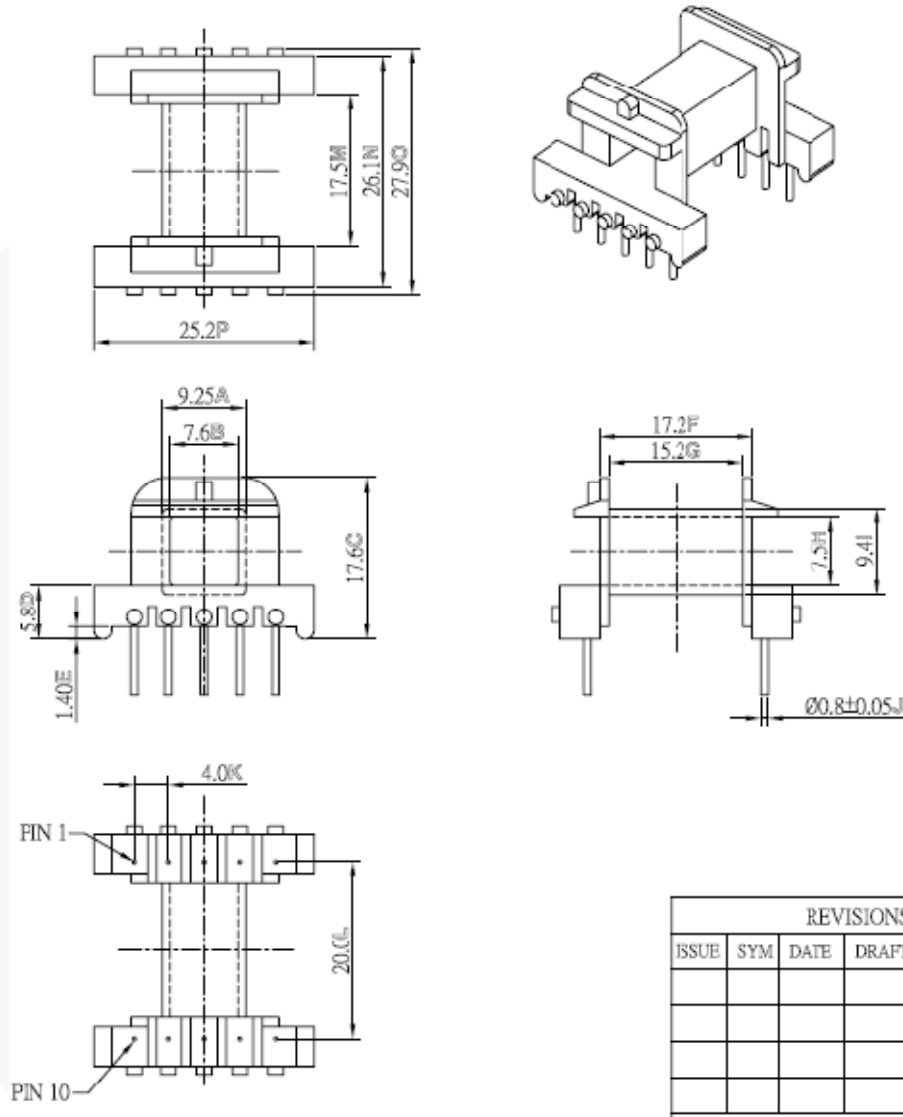
COMPONENT	MAT'L	MANUFACTURE	UL FILE NO.
1.CORE	S6,SGB or equal	Ferrite core DRWW 6x8 Jaw Shianq.	
2.WIRE	UEW-B	Chuen Yih Wire CO.,LTD	E154709(S)
	UEW-2	Jung Shing Wire CO.,LTD	E79029(S)
	UEW	Tai-I Electric Wire & Cable CO.,LTD	E85640(S)
3.TUBE	KUHS-225	Korea Unichenm CO.,LTD	E157822(S)
	811	Sumitomo Electric Industries CO.,LTD	E48762(S)
4.TERMINALS	Tin coated- Copper wire	Will for special wire CORP	

UNIT	m/m	DRAWN	CHECK	TITLE	LINE FILTER
TEL	(02)29450588	Ci wun Chen	Guo long Huang	IDENT NO.	TRN-0216
FAX	(02)29447647	SEN HUEI INDUSTRIAL CO.,LTD.		DWG NO.	I0033
No.26-1, Lane 128, Sec. 2, Singnan Rd., Jhonghe City, Taipei County 235, Taiwan (R.O.C.)					

## 9. Transformer Specification

Customer				P/N:	TRN-0310
DATE	05/05/2011	Version	A	Page	1/4

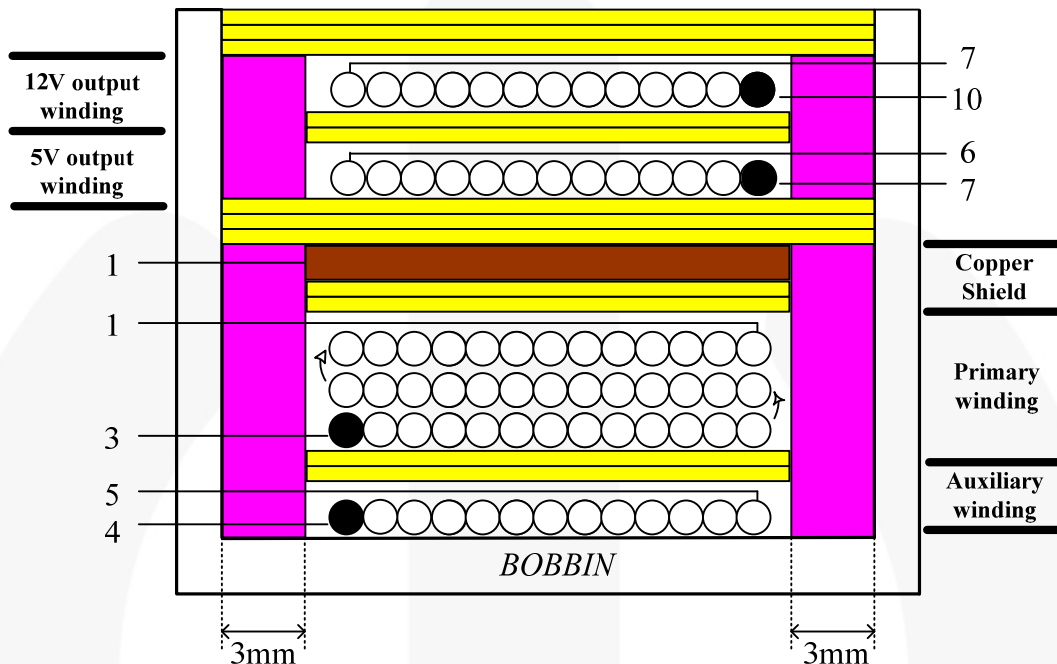
### 1.DIMENSION



UNIT	m/m	DRAWN	CHECK	TITLE	TRANS
TEL	(02)29450588	Ci wun Chen	Guo long Huang	IDENT N.O.	TRN-0310
FAX	(02)29447647	SEN HUEI INDUSTRIAL CO.,LTD.		D W G N.O.	I2509
No.26-1, Lane 128, Sec. 2, Singnan Rd., Jhonghe City, Taipei County 235, Taiwan (R.O.C.)					

Customer				P/N:	TRN-0310
DATE	05/05/2011	Version	A	Page	2/4

**2.SCHEMATIC:**



1. When W2 is winding, it should be 3 layers.
2. When W4 is winding, it must wind one layer.
3. When COPPER SHIELD is winding, 3mm barrier tape must exist both primary and secondary side.

NO	TERMINAL		WIRE	Ts	INSULATION		BARRIER	
	S	F			Ts	pri	sec	
W1	4	5	2UEW 0.33*2	13	2	3mm	3mm	
W2	3	1	2UEW 0.3*1	81	2	3mm	3mm	
W3	1	-	COPPER SHIELD	1.2	3	3mm	3mm	
W4	7	6	2UEW 0.37*4	6	2	3mm	3mm	
W5	10	7	2UEW 0.42*3	7	3	3mm	3mm	
			CORE ROUNDING TAPE		3			

UNIT	m/m	DRAWN	CHECK	TITLE	TRANS
TEL	(02)29450588	Ci wun Chen	Guo long Huang	IDENT N.O.	TRN-0310
FAX	(02)29447647	SEN HUEI INDUSTRIAL CO.,LTD.		D W G N.O.	I2509
No.26-1, Lane 128, Sec. 2, Singnan Rd., Jhonghe City, Taipei County 235, Taiwan (R.O.C.)					



Customer				P/N:	TRN-0310
DATE	05/05/2011	Version	A	Page	3/4

### 3.ELECTRICAL SPECIFICATION

3.Inductance test: at 67KHz ,1.0V

P(5-4) : 1.4 mH +-5%

3.2 DC Resistance test at 25°C

P(3-1):.1.17Ohmo max      P(10-6) : 44.94Ohmo max

P(4-5): 78.96 Ohmo max

3.3 Hi-pot test:

AC 2.0K V /60Hz/5mA hi-pot for one minute between primary to secondary.

AC 1.0K V /60Hz/5mA hi-pot for one minute between primary to core.

AC 1.0K V /60Hz/5mA hi-pot for one minute between secondary to core.

3.4 Insulation test :

The insulation resistance is between pri to sec and windings to core measured by DC 500V, must be over 100MOhm.

3.5 Terminal strength :

1.5Kg on terminals for 10 seconds, test the breakdown.

UNIT	m/m	DRAWN	CHECK	TITLE	TRANS
TEL	(02)29450588	Ci wun Chen	Guo long Huang	IDENT N.O.	TRN-0310
FAX	(02)29447647	SEN HUEI INDUSTRIAL CO.,LTD.		D W G N.O.	I2509
No.26-1, Lane 128, Sec. 2, Singnan Rd., Jhonghe City, Taipei County 235, Taiwan (R.O.C.)					

### SPECIFICATION APPROVAL

Customer				P/N:	TRN-0310
DATE	05/05/2011	Version	A	Page	4/4

#### 4. MATERIALS LIST

COMPONENT	MATERIALS	MANUFACTURE	FILE NO.
1.Bobbin	Phenolic 94V- 0,T373J,150□	EF-25(TF-2502) Chang Chun plastics CO.,LTD	E59481(S)
2.Core	PC-40,BH2,2E6 3C85,MZ-4	Ferrite core EF-25 TDK,Tokin.Tomita.Philip.Nicera.	
3.Wire	UEWE 130□	Tai-I electronic wire & cable CO.,LTD	E85640 ( S )
	UEW-2 130□	Jung Shing wire CO.,LTD	E174837
	UEW-B 130□	Chuen Yih wire CO.,LTD	E154709 ( S )
4.Varnish	BC-346A 180□	John C Dolph CO.,LTD.	E51047 ( M )
	468-2FC 130□	Ripley Resin Engineering Co Inc.	E81777 ( N )
5.Tape t=0.064mm	31CT 130□	Nitto Denk Corp	E34833 ( M )
	Polyester 3M #1350(b) 130□	Minnesota Mining &MFG CO.,LTD CTI Material Group□	E17385 ( N )
6.Tube	Teflon tube TFL 150V,200□	Great Holding Industrial CO.,LTD	E156256 ( S )
7.Terminals	Tin coated- Copper wire	Will for special wire CORP	
8.Shield	Copper foil	Hitachi cable ltd. (copper foil : 0.025tx9mm+TAPE)	

UNIT	m/m	DRAWN	CHECK	TITLE	TRANS
TEL	(02)29450588	Ci wun Chen	Guo long Huang	IDENT N O.	TRN-0310
FAX	(02)29447647	SEN HUEI INDUSTRIAL CO.,LTD.		D W G N O.	I2509
No.26-1, Lane 128, Sec. 2, Singnan Rd., Jhonghe City, Taipei County 235, Taiwan (R.O.C.)					

## 10. Bill of Materials

Component	Qty.	Part Number	Manufacturer	Reference
JUMPER WIRE 0.6*52mm	1			JP1
Metal Oxide Film Resistor 2W-S 100KΩ ±5%	1			R104
Chip Resistor 0805 0Ω ±5%	1			R105
Chip Resistor 0805 510Ω ±5%	1			R205
Chip Resistor 0805 9K1Ω ±1%	1			R106
Chip Resistor 0805 12K1Ω ±1%	1			R207
Chip Resistor 0805 30KΩ ±5%	1			R208
Chip Resistor 1206 2K7Ω ±5%	1			R204
Chip Resistor 1206 12K1Ω ±1%	1			R206
Chip Resistor 1206 68KΩ ±5%	1			R103
NTC 8φ 5Ω SCK053	1			RT101
Ceramic Capacitor 472P 1KV +80/-20%	1			C104
0805 MLCC X7R ±10% 103P 50V	1			C107
0805 MLCC X7R ±10% 104P 50V	2			C106, C207
Electrolytic Capacitor 47μF 50V 105°C	1	8*11	Jakycon	C105
Electrolytic Capacitor 47μF 400V 105°C	1	18*20 WXA	Rubycon	C103
Electrolytic Capacitor 470μF 25V 105°C	2	10*16	NCC	C202, C203
Electrolytic Capacitor 1000μF 10V 105°C	2	8*16 GK	SAMXON	C205 C206
X2 Capacitor 0.1μF 275V ±20%	1			C101
Y1 Capacitor 102P 250V ±20%	1			CY301
Inductor DR6X8 5μH	2	TRN0216	SEN HUEI	L201A, L202A
Inductor UU9.8 50mH	1	TRN0177	SEN HUEI	LF101
Transformer EF-25-H 1.4mH	1	TRN0310	SEN HUEI	T301
Diode 1A/700V DO-41	6	1N4007	Fairchild Semiconductor	D101, D102, D103, D104, D105, D106
Schottky Diode 3A/100V DO-201AD	1	SB3100	Fairchild Semiconductor	D201
Schottky Diode 3A/60V DO-201AD	1	SB360	Fairchild Semiconductor	D202
IC FOD817B DIP	1		Fairchild Semiconductor	IC301
REGULATOR KA431L ±0.5%	1		Fairchild Semiconductor	IC201
IC FSL126MR DIP	1		Fairchild Semiconductor	IC101
FUSE BUSS SR-5 1A/250V	1			F101
Varistor 10φ470V	1			RV101
PCB PLM0146 REV0	1			

## 11. Revision History

Rev.	Date	Description
1.0.0		Change User Guide EVB number from FEB432001 to FEBFSL126MR_H432v1
1.0.1	March 2012	Formatting & editing pass by Tech Docs prior to posting

### WARNING AND DISCLAIMER

Replace components on the Evaluation Board only with those parts shown on the parts list (or Bill of Materials) in the Users' Guide. Contact an authorized Fairchild representative with any questions.

This board is intended to be used by certified professionals, in a lab environment, following proper safety procedures. Use at your own risk. The Evaluation board (or kit) is for demonstration purposes only and neither the Board nor this User's Guide constitute a sales contract or create any kind of warranty, whether express or implied, as to the applications or products involved. Fairchild warrants that its products meet Fairchild's published specifications, but does not guarantee that its products work in any specific application. Fairchild reserves the right to make changes without notice to any products described herein to improve reliability, function, or design. Either the applicable sales contract signed by Fairchild and Buyer or, if no contract exists, Fairchild's standard Terms and Conditions on the back of Fairchild invoices, govern the terms of sale of the products described herein.

#### DISCLAIMER

FAIRCHILD SEMICONDUCTOR RESERVES THE RIGHT TO MAKE CHANGES WITHOUT FURTHER NOTICE TO ANY PRODUCTS HEREIN TO IMPROVE RELIABILITY, FUNCTION, OR DESIGN. FAIRCHILD DOES NOT ASSUME ANY LIABILITY ARISING OUT OF THE APPLICATION OR USE OF ANY PRODUCT OR CIRCUIT DESCRIBED HEREIN; NEITHER DOES IT CONVEY ANY LICENSE UNDER ITS PATENT RIGHTS, NOR THE RIGHTS OF OTHERS.

#### LIFE SUPPORT POLICY

FAIRCHILD'S PRODUCTS ARE NOT AUTHORIZED FOR USE AS CRITICAL COMPONENTS IN LIFE SUPPORT DEVICES OR SYSTEMS WITHOUT THE EXPRESS WRITTEN APPROVAL OF THE PRESIDENT OF FAIRCHILD SEMICONDUCTOR CORPORATION.

As	used	herein:1.
Life support devices or systems are devices or systems which, (a) are intended for surgical implant into the body, or (b) support or sustain life, or (c) whose failure to perform when properly used in accordance with instructions for use provided in the labeling, can be reasonably expected to result in significant injury to the user.		2. A critical component is any component of a life support device or system whose failure to perform can be reasonably expected to cause the failure of the life support device or system, or to affect its safety or effectiveness.

### ANTI-COUNTERFEITING POLICY

Fairchild Semiconductor Corporation's Anti-Counterfeiting Policy. Fairchild's Anti-Counterfeiting Policy is also stated on our external website, www.fairchildsemi.com, under Sales Support.

Counterfeiting of semiconductor parts is a growing problem in the industry. All manufacturers of semiconductor products are experiencing counterfeiting of their parts. Customers who inadvertently purchase counterfeit parts experience many problems such as loss of brand reputation, substandard performance, failed applications, and increased cost of production and manufacturing delays. Fairchild is taking strong measures to protect ourselves and our customers from the proliferation of counterfeit parts. Fairchild strongly encourages customers to purchase Fairchild parts either directly from Fairchild or from Authorized Fairchild Distributors who are listed by country on our web page cited above. Products customers buy either from Fairchild directly or from Authorized Fairchild Distributors are genuine parts, have full traceability, meet Fairchild's quality standards for handling and storage and provide access to Fairchild's full range of up-to-date technical and product information. Fairchild and our Authorized Distributors will stand behind all warranties and will appropriately address any warranty issues that may arise. Fairchild will not provide any warranty coverage or other assistance for parts bought from Unauthorized Sources. Fairchild is committed to combat this global problem and encourage our customers to do their part in stopping this practice by buying direct or from authorized distributors.

### EXPORT COMPLIANCE STATEMENT

These commodities, technology, or software were exported from the United States in accordance with the Export Administration Regulations for the ultimate destination listed on the commercial invoice. Diversion contrary to U.S. law is prohibited.

U.S. origin products and products made with U.S. origin technology are subject to U.S. Re-export laws. In the event of re-export, the user will be responsible to ensure the appropriate U.S. export regulations are followed.