

4

3

2

1

THIS DRAWING IS UNPUBLISHED. RELEASED FOR PUBLICATION 2009
 © COPYRIGHT 2009 BY TYCO ELECTRONICS CORPORATION. ALL RIGHTS RESERVED.

LOC		DIST		REVISIONS			
P	LTR	DESCRIPTION		DATE	DWN	APVD	
	BA	NEW RELEASE		29JUNE2010	PT	St.P	

FOR FURTHER INFORMATION SEE DATA SHEET FOR
 SERIES HOLCO, AXIAL LEADED PRECISION RESISTORS

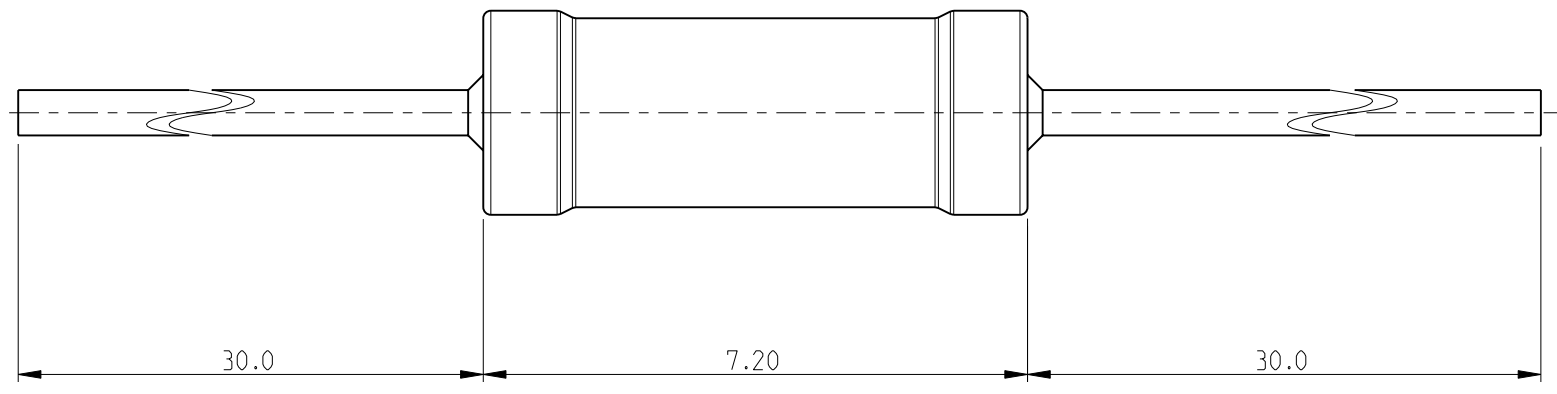
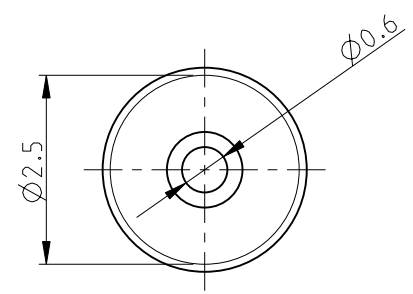

RoHS Compliant

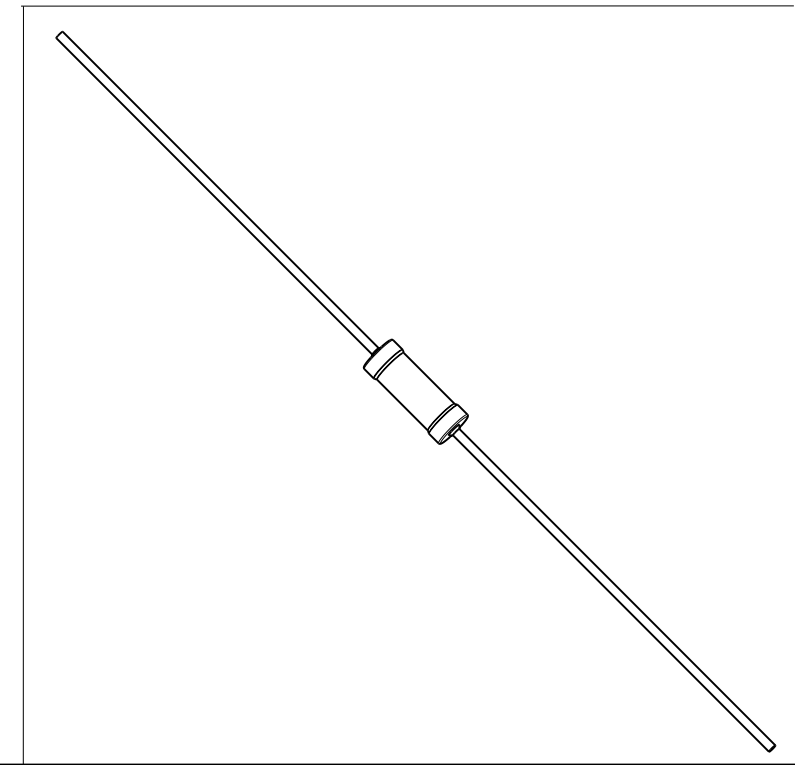

<small>THIS DRAWING IS A CONTROLLED DOCUMENT FOR TYCO ELECTRONICS CORPORATION IT IS SUBJECT TO CHANGE AND THE CONTROLLING ENGINEERING ORGANIZATION SHOULD BE CONTACTED FOR THE LATEST REVISION.</small>		DWN 29JUNE2010 PARUSURAM.T		Tyco Electronics Corporation Dorcan, Swindon, SN3 5HH	
DIMENSIONS: mm		TOLERANCES UNLESS OTHERWISE SPECIFIED:		NAME AXIAL LEADED PRECISION RESISTORS SERIES HOLCO H8	
		0 PLC ± 0.2 1 PLC ± 0.1 2 PLC $\pm -$ 3 PLC $\pm -$ 4 PLC $\pm -$ ANGLES $\pm 5^\circ$		APVD 29JUNE2010 STEPHEN.P	
MATERIAL -		FINISH -		PRODUCT SPEC -	
				APPLICATION SPEC -	
				WEIGHT -	
CUSTOMER DRAWING				SIZE A3 CAGE CODE 00779 DRAWING NO C-1879683 RESTRICTED TO -	
				SCALE 10:1 SHEET 1 OF 1 REV BA	