



Is Now Part of



**ON Semiconductor®**

To learn more about ON Semiconductor, please visit our website at  
[www.onsemi.com](http://www.onsemi.com)

ON Semiconductor and the ON Semiconductor logo are trademarks of Semiconductor Components Industries, LLC dba ON Semiconductor or its subsidiaries in the United States and/or other countries. ON Semiconductor owns the rights to a number of patents, trademarks, copyrights, trade secrets, and other intellectual property. A listing of ON Semiconductor's product/patent coverage may be accessed at [www.onsemi.com/site/pdf/Patent-Marking.pdf](http://www.onsemi.com/site/pdf/Patent-Marking.pdf). ON Semiconductor reserves the right to make changes without further notice to any products herein. ON Semiconductor makes no warranty, representation or guarantee regarding the suitability of its products for any particular purpose, nor does ON Semiconductor assume any liability arising out of the application or use of any product or circuit, and specifically disclaims any and all liability, including without limitation special, consequential or incidental damages. Buyer is responsible for its products and applications using ON Semiconductor products, including compliance with all laws, regulations and safety requirements or standards, regardless of any support or applications information provided by ON Semiconductor. "Typical" parameters which may be provided in ON Semiconductor data sheets and/or specifications can and do vary in different applications and actual performance may vary over time. All operating parameters, including "Typicals" must be validated for each customer application by customer's technical experts. ON Semiconductor does not convey any license under its patent rights nor the rights of others. ON Semiconductor products are not designed, intended, or authorized for use as a critical component in life support systems or any FDA Class 3 medical devices or medical devices with a same or similar classification in a foreign jurisdiction or any devices intended for implantation in the human body. Should Buyer purchase or use ON Semiconductor products for any such unintended or unauthorized application, Buyer shall indemnify and hold ON Semiconductor and its officers, employees, subsidiaries, affiliates, and distributors harmless against all claims, costs, damages, and expenses, and reasonable attorney fees arising out of, directly or indirectly, any claim of personal injury or death associated with such unintended or unauthorized use, even if such claim alleges that ON Semiconductor was negligent regarding the design or manufacture of the part. ON Semiconductor is an Equal Opportunity/Affirmative Action Employer. This literature is subject to all applicable copyright laws and is not for resale in any manner.

# FAN7385

## Dual-Channel High-Side Gate-Drive IC

### Features

- Floating Channel for Bootstrap Operation to +600V
- Typically 350mA/650mA Sourcing/Sinking Current Driving Capability
- Extended Allowable Negative  $V_S$  Swing to -9.8V for Signal Propagation at  $V_{DD}=V_{BS}=15V$
- High-Side Output In-Phase of Input Signal
- $V_{DD}$  &  $V_{BS}$  Supply Range from 10V to 20V
- 3.3V and 5V Input Logic Compatible
- Built-in Common Mode dv/dt Noise Canceling Circuit
- Built-in UVLO Functions for Both Channels

### Applications

- Normal Half-Bridge and Full-Bridge Driver
- PDP Energy Recovery Switch Control Driver
- Switching Mode Power Supply

### Description

The FAN7385 is a monolithic high side gate drive IC designed for high voltage, high speed driving MOSFETs and IGBTs operating up to +600V.

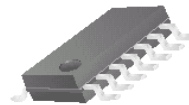
Fairchild's high-voltage process and common-mode noise canceling technique provide stable operation of high-side drivers under high-dv/dt noise circumstances.

An advanced level-shift circuit allows high-side gate driver operation up to  $V_S = -9.8V$  (typical) for  $V_{BS} = 15V$ .

The UVLO circuits prevent malfunction when  $V_{BS1}$  and  $V_{BS2}$  are lower than the specified threshold voltage.

Output drivers typically source/sink 350mA/650mA, respectively, which is suitable for dual high-side switches and half-bridge inverters.

14-SOP



### Ordering Information

Part Number	Package	Pb-Free	Operating Temperature Range	Packing Method
FAN7385M <sup>(1)</sup>	14-SOP	Yes	-40°C ~ 125°C	Tube
FAN7385MX <sup>(1)</sup>				Tape & Reel

**Note:**

1. These devices passed wave soldering test by JESD22A-111.

## Typical Application Diagrams

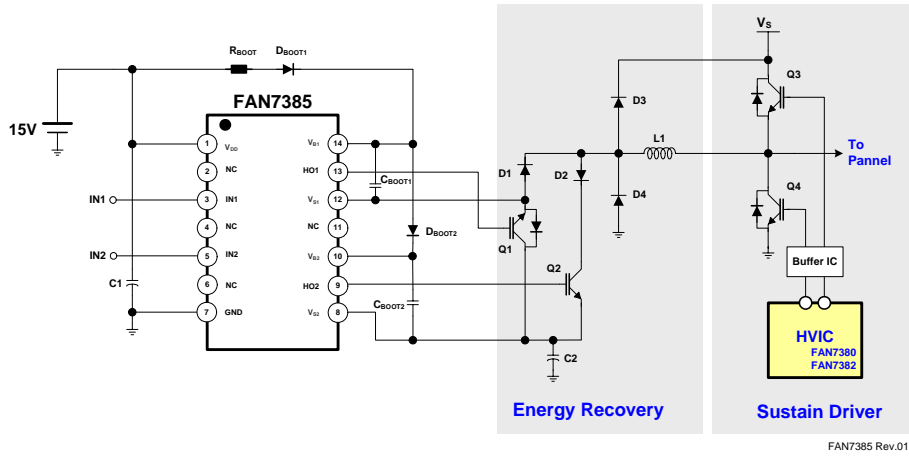


Figure 1. Floated Bidirectional Switch Control for PDP application

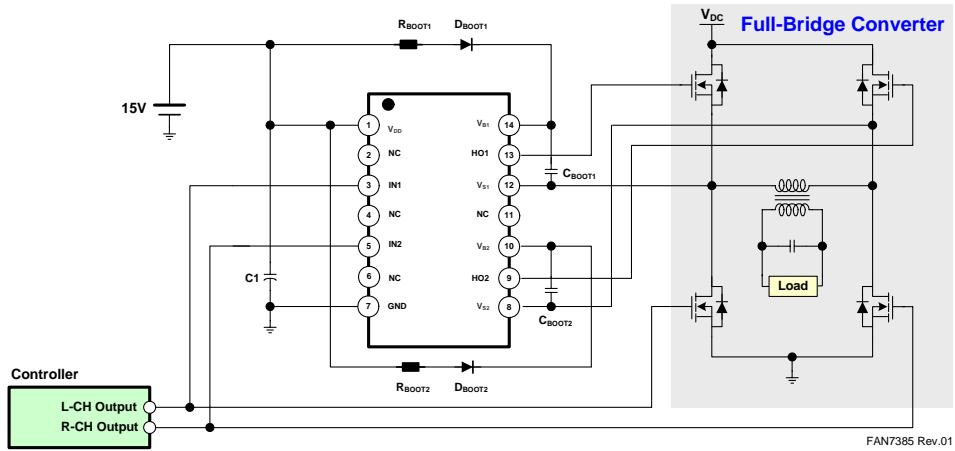


Figure 2. Full-Bridge Power Supply Application

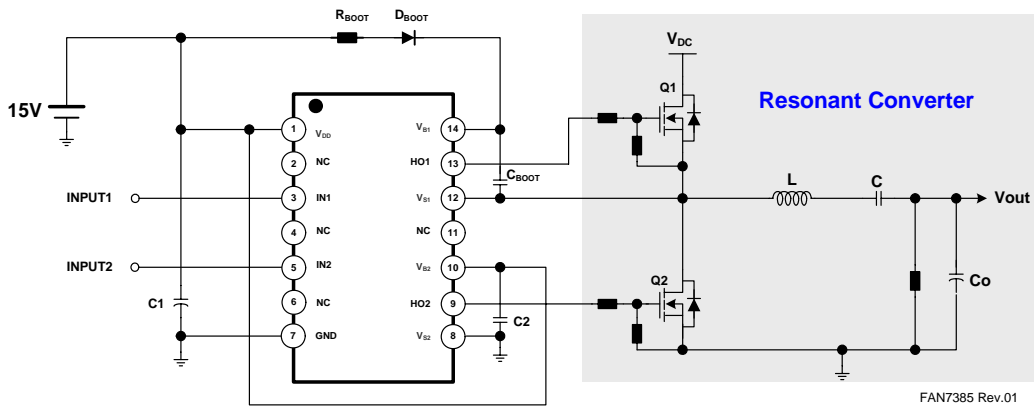


Figure 3. Half-Bridge LCC Resonant Converter Application



## Pin Configuration

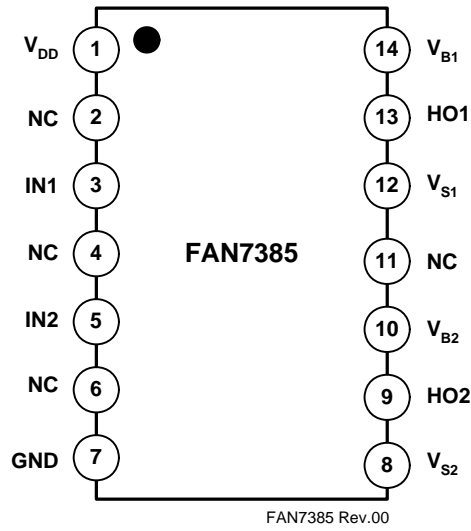


Figure 5. Pin Configuration (Top View)

## Pin Definitions

Pin #	Name	Description
1	$V_{DD}$	Power supply
2	NC	Not connection
3	IN1	Channel 1 control input
4	NC	Not connection
5	IN2	Channel 2 control input
6	NC	Not connection
7	GND	Ground
8	$V_{S2}$	Channel 2 floating supply return
9	HO2	Channel 2 output
10	$V_{B2}$	Channel 2 floating supply
11	NC	Not connection
12	$V_{S1}$	Channel 1 floating supply return
13	HO1	Channel 1 output
14	$V_{B1}$	Channel 1 floating supply

## Absolute Maximum Ratings

Stresses exceeding the absolute maximum ratings may damage the device. The device may not function or be operable above the recommended operating conditions and stressing the parts to these levels is not recommended. In addition, extended exposure to stresses above the recommended operating conditions may affect device reliability. The absolute maximum ratings are stress ratings only.  $T_A=25^{\circ}\text{C}$ , unless otherwise specified.

Symbol	Parameter	Min.	Max.	Unit
$V_S$	High-side offset voltage $V_{S1}, V_{S2}$	$V_B-25$	$V_B+0.3$	V
$V_B$	High-side floating supply voltage $V_{B1}, V_{B2}$	-0.3	625	V
$V_{HO}$	High-side floating output voltage $H_{O1}, H_{O2}$	$V_S-0.3$	$V_B+0.3$	V
$V_{DD}$	Low-side and logic-fixed supply voltage	-0.3	25	V
$V_{IN}$	Logic input voltage (IN1, IN2)	-0.3	$V_{DD}+0.3$	V
GND	Logic ground	$V_{DD}-25$	$V_{DD}+0.3$	V
$dV_S/dt$	Allowable offset voltage slew rate		50	V/ns
$P_D^{(2)(3)(4)}$	Power dissipation		1.0	W
$\theta_{JA}$	Thermal resistance, junction-to-ambient		110	$^{\circ}\text{C}/\text{W}$
$T_J$	Junction temperature		150	$^{\circ}\text{C}$
$T_S$	Storage temperature		150	$^{\circ}\text{C}$

### Notes:

- Mounted on 76.2 x 114.3 x 1.6mm PCB (FR-4 glass epoxy material).
- Refer to the following standards:
  - JESD51-2: Integral circuits thermal test method environmental conditions - natural convection
  - JESD51-3: Low effective thermal conductivity test board for leaded surface mount packages
- Do not exceed  $P_D$  under any circumstances.

## Recommended Operating Conditions

The Recommended Operating Conditions table defines the conditions for actual device operation. Recommended operating conditions are specified to ensure optimal performance to the datasheet specifications. Fairchild does not recommend exceeding them or designing to Absolute Maximum Ratings.

Symbol	Parameter	Condition	Min.	Max.	Unit
$V_B$	High-side floating supply voltage		$V_S+10$	$V_S+20$	V
$V_S$	High-side floating supply offset voltage		$6-V_{DD}$	600	V
$V_{DD}$	Supply voltage		10	20	V
$V_{HO}$	High-side (HO1, HO2) output voltage		$V_S$	$V_B$	V
$V_{IN}$	Logic input voltage (IN1, IN2)		GND	$V_{DD}$	V
$T_A$	Ambient temperature		-40	125	$^{\circ}\text{C}$

## Electrical Characteristics

$V_{BIAS}$  ( $V_{DD}$ ,  $V_{BS1}$ ,  $V_{BS2}$ ) = 15.0V,  $T_A$  = 25°C, unless otherwise specified. The  $V_{IN}$  and  $I_{IN}$  parameters are referenced to GND. The  $V_O$  and  $I_O$  parameters are referenced to  $V_{S1}$  and  $V_{S2}$  and are applicable to the respective outputs HO1 and HO2.

Symbol	Characteristics	Condition	Min.	Typ.	Max.	Unit
<b>SUPPLY CURRENT SECTION</b>						
$I_{QDD}$	Quiescent $V_{DD}$ supply current	$V_{IN1}=V_{IN2}=0V$ or 5V		28	50	$\mu A$
$I_{PDD}$	Operating $V_{DD}$ supply current	$f_{IN1}=f_{IN2}=10kHz$ , rms value		35	70	$\mu A$
<b>BOOTSTRAPPED POWER SUPPLY SECTION</b>						
$V_{BSUV+}$	$V_{BS1}$ and $V_{BS2}$ supply under-voltage positive going threshold	$V_{BS1}=V_{BS2}=\text{Sweep}$	8.2	9.1	10.2	V
$V_{BSUV-}$	$V_{BS1}$ and $V_{BS2}$ supply under-voltage negative going threshold	$V_{BS1}=V_{BS2}=\text{Sweep}$	7.6	8.5	9.6	V
$V_{BSHYS}$	$V_{BS1}$ and $V_{BS2}$ supply under-voltage lockout hysteresis	$V_{BS1}=V_{BS2}=\text{Sweep}$		0.6		V
$I_{LK}$	Offset supply leakage current	$V_B=V_S=600V$			10	$\mu A$
$I_{QBS1,2}$	Quiescent $V_{BS1}$ and $V_{BS2}$ supply current	$V_{IN1}=0V$ or 5V		50	85	$\mu A$
$I_{PBS1,2}$	Operating $V_{BS1}$ and $V_{BS2}$ supply current	$f_{IN1}=10kHz$ , rms value		220	300	$\mu A$
<b>GATE DRIVER OUTPUT SECTION</b>						
$V_{OH}$	High-level output voltage, $V_{BIAS}-V_O$	$I_O=0mA$ (No Load)			30	mV
$V_{OL}$	Low-level output voltage, $V_O$	$I_O=0mA$ (No Load)			30	mV
$I_{O+}$	Output HIGH short-circuit pulse current	$V_O=0V$ , $V_{IN}=5V$ with $PW<10\mu s$	250	350		mA
$I_{O-}$	Output LOW short-circuit pulsed current	$V_O=15V$ , $V_{IN}=0V$ with $PW<10\mu s$	500	650		mA
$V_S$	Allowable negative $V_S$ pin voltage for IN signal propagation to $H_O$			-9.8	-7.0	V
<b>LOGIC INPUT SECTION (IN1 AND IN2)</b>						
$V_{IH}$	Logic "1" input voltage		2.5			V
$V_{IL}$	Logic "0" input voltage				1.3	V
$I_{IN+}$	Logic "1" input bias current	$V_{IN}=5V$		10	20	$\mu A$
$I_{IN-}$	Logic "0" input bias current	$V_{IN}=0V$			2.0	$\mu A$
$R_{IN}$	Input pull-down resistance		400	500	600	$K\Omega$

## Dynamic Electrical Characteristics

$T_A=25^\circ C$ ,  $V_{BIAS}$  ( $V_{DD}$ ,  $V_{BS1}$ ,  $V_{BS2}$ ) = 15.0V,  $V_{S1} = V_{S2} = GND$ ,  $C_{Load} = 1000pF$  unless otherwise specified.

Symbol	Parameter	Conditions	Min.	Typ.	Max.	Unit
$t_{on}$	Turn-on propagation delay	$V_S=0V$		110	180	ns
$t_{off}$	Turn-off propagation delay	$V_S=0V$ or $600V^{(5)}$		110	180	ns
$t_r$	Turn-on rise time			50	90	ns
$t_f$	Turn-off fall time			30	70	ns
MT	Delay matching, Channel 1 & 2 turn-on/off			0		ns

### Notes:

5. This parameter guaranteed by design.

Typical Characteristics

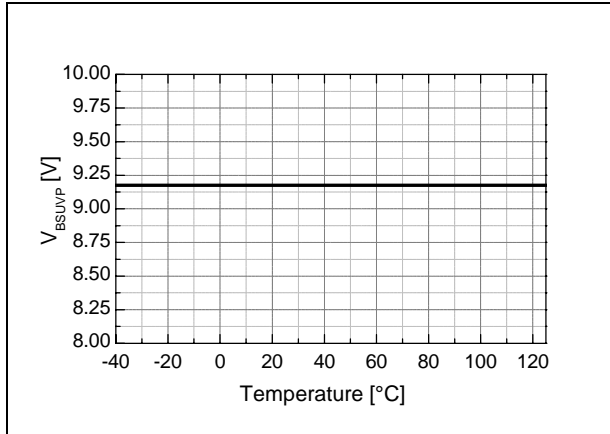


Figure 6. V<sub>BS</sub> UVLO (+) vs. Temperature

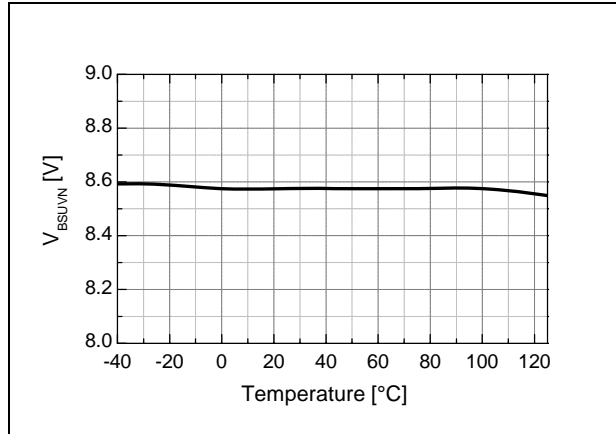


Figure 7. V<sub>BS</sub> UVLO (-) vs. Temperature

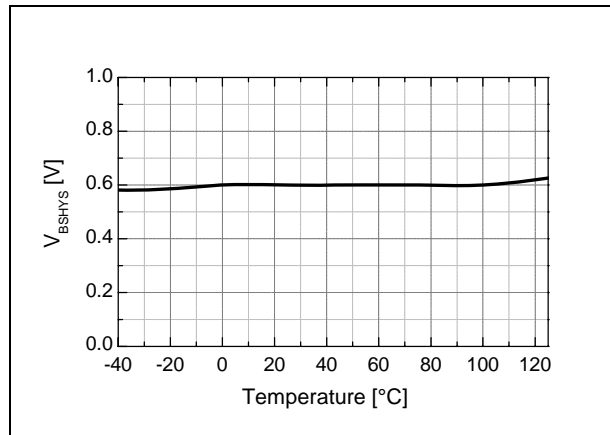


Figure 8. V<sub>BS</sub> UVLO Hysteresis vs. Temperature

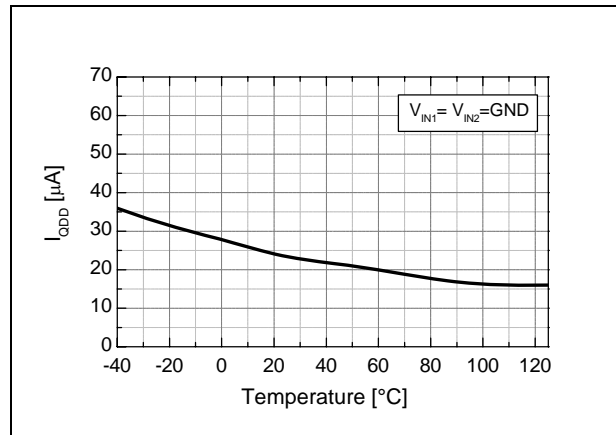


Figure 9. V<sub>DD</sub> Quiescent Current vs. Temperature

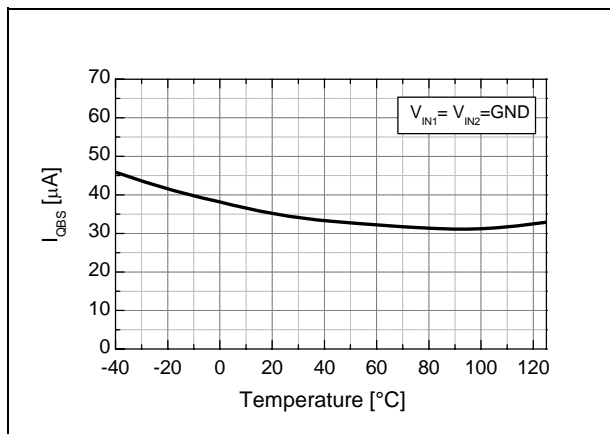


Figure 10. V<sub>BS</sub> Quiescent Current vs. Temperature

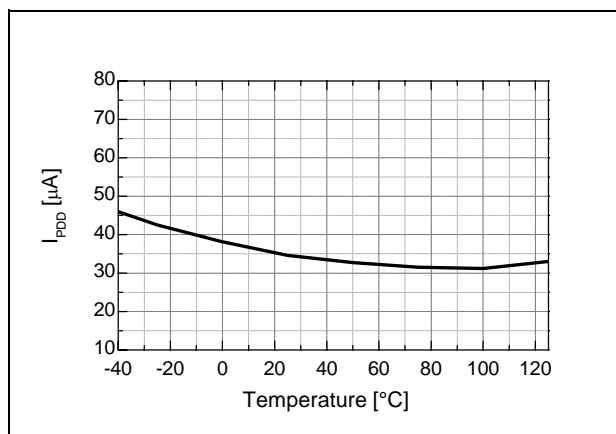
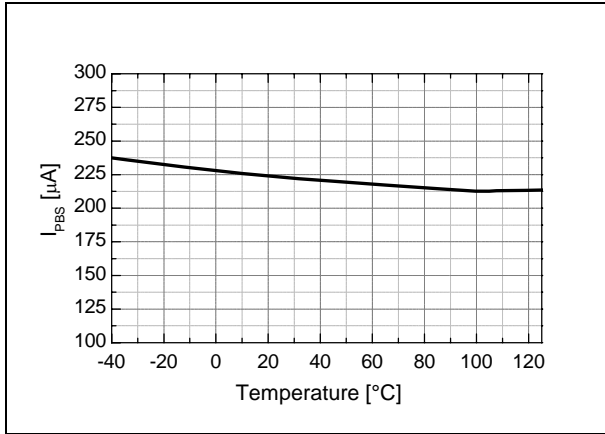


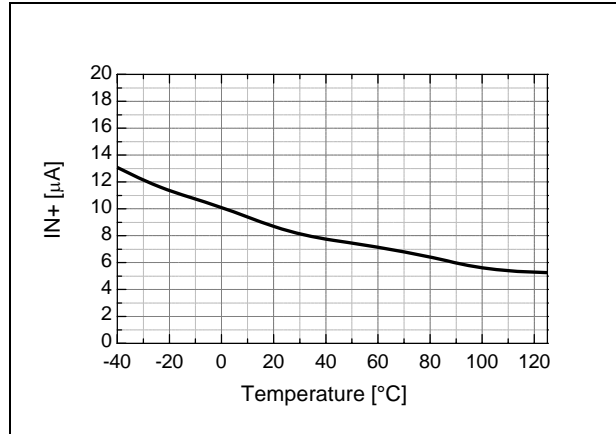
Figure 11. V<sub>DD</sub> Operating Current vs. Temperature



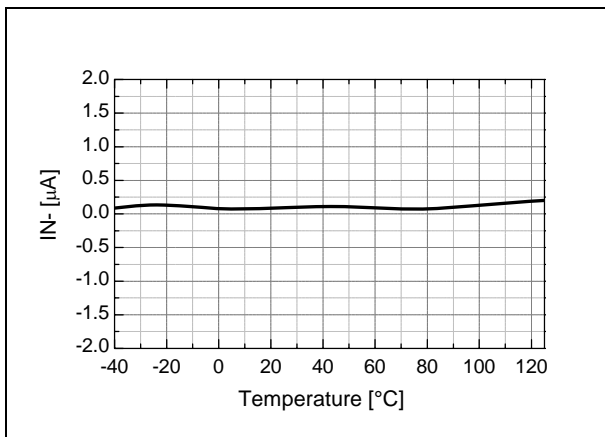
**Typical Characteristics** (Continued)



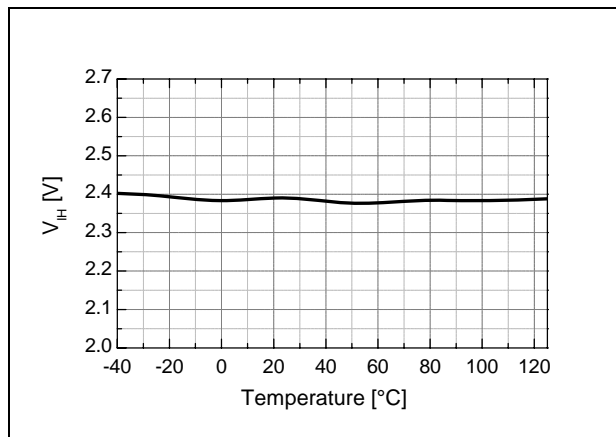
**Figure 12.  $V_{BS}$  Operating Current vs. Temperature**



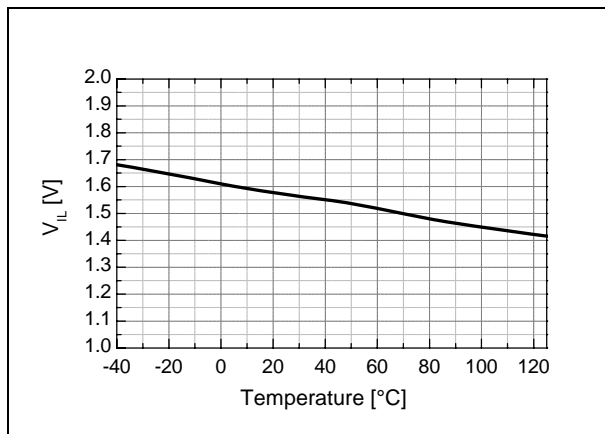
**Figure 13. Logic High Input Current vs. Temperature**



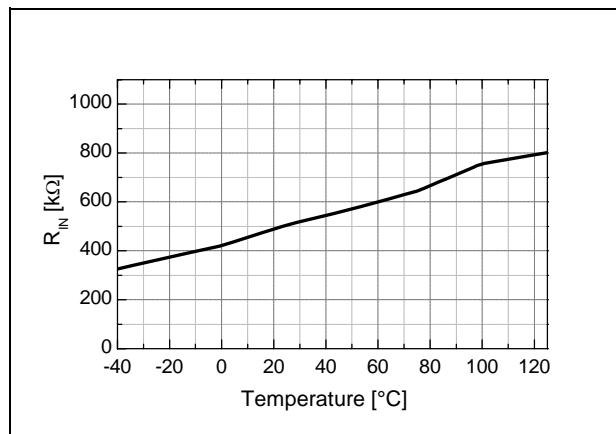
**Figure 14. Logic Low Input Current vs. Temperature**



**Figure 15. Logic Input High Voltage vs. Temperature**

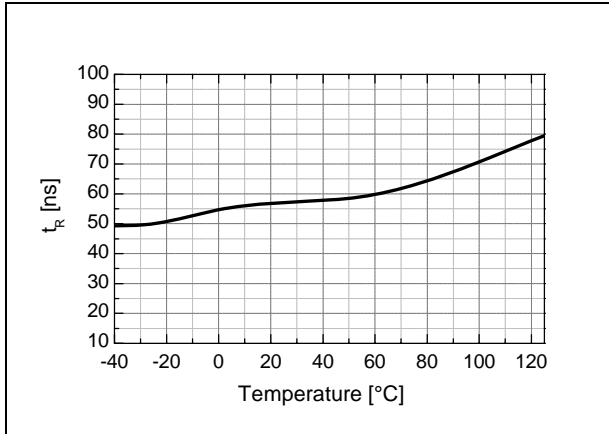


**Figure 16. Logic Input Low Voltage vs. Temperature**

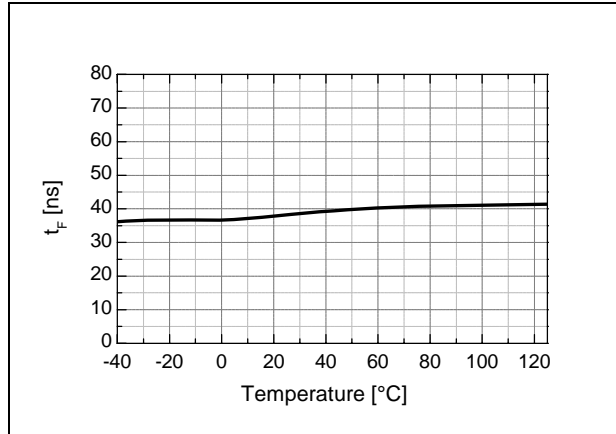


**Figure 17. Logic Input Resistance vs. Temperature**

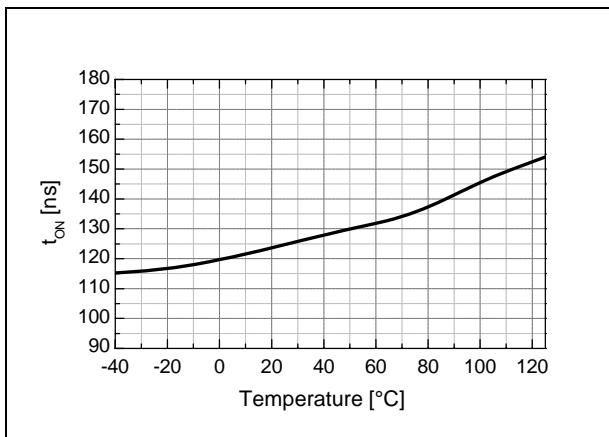
**Typical Characteristics** (Continued)



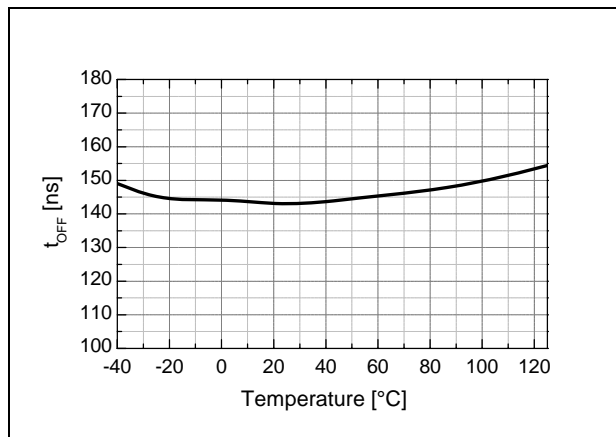
**Figure 18. Rising Time vs. Temperature**



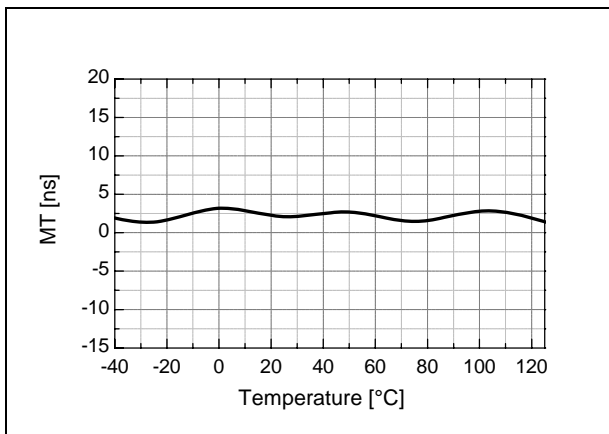
**Figure 19. Falling Time vs. Temperature**



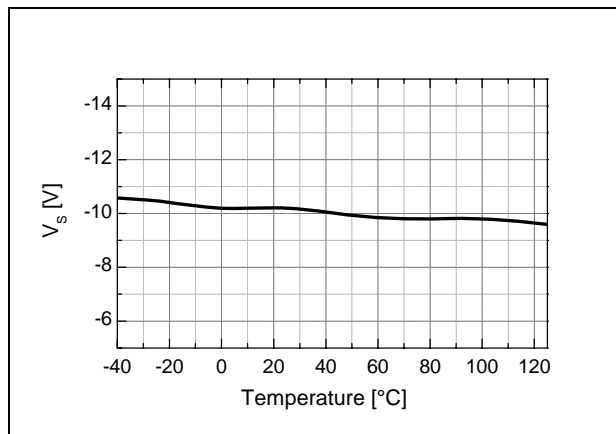
**Figure 20. Turn-On Delay Time vs. Temperature**



**Figure 21. Turn-Off Delay Time vs. Temperature**



**Figure 22. Delay Matching Time vs. Temperature**



**Figure 23. Allowable Negative V<sub>S</sub> Voltage for Signal Propagation to High Side vs. Temperature**

Typical Characteristics (Continued)

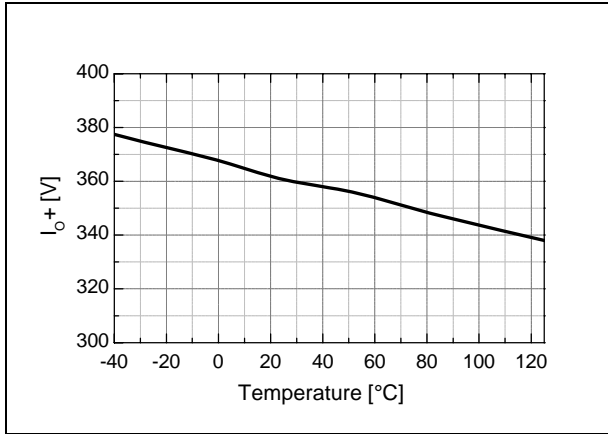


Figure 24. Output High Short-Circuit Pulse Current vs. Temperature

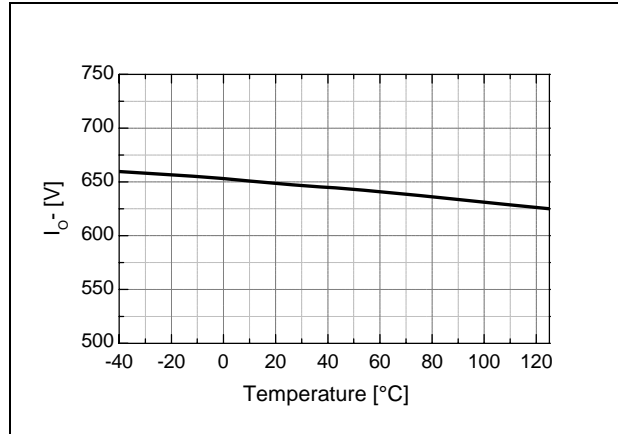


Figure 25. Output Low Short-Circuit Pulse Current vs. Temperature

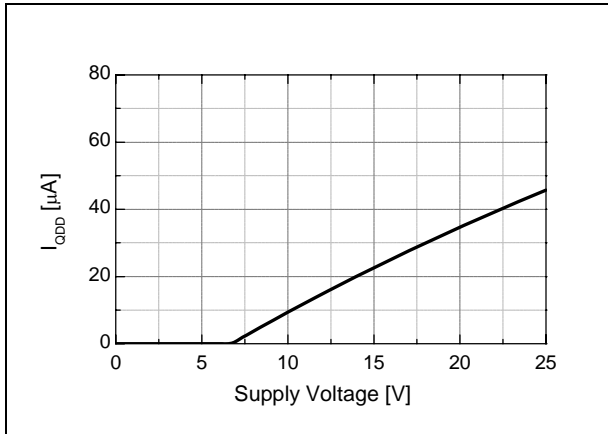


Figure 26.  $V_{DD}$  Quiescent Current vs. Supply Voltage

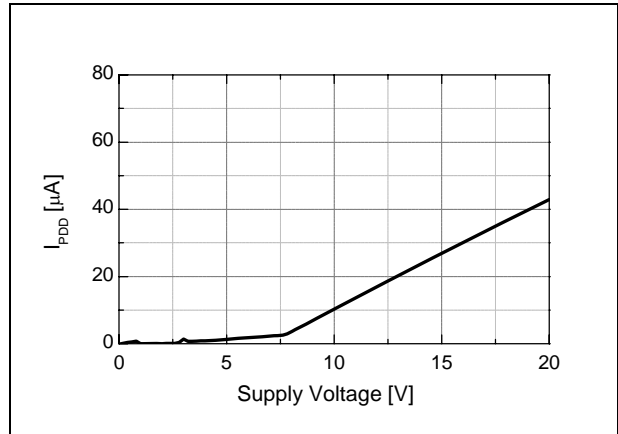


Figure 27.  $V_{DD}$  Operating Current vs. Supply Voltage

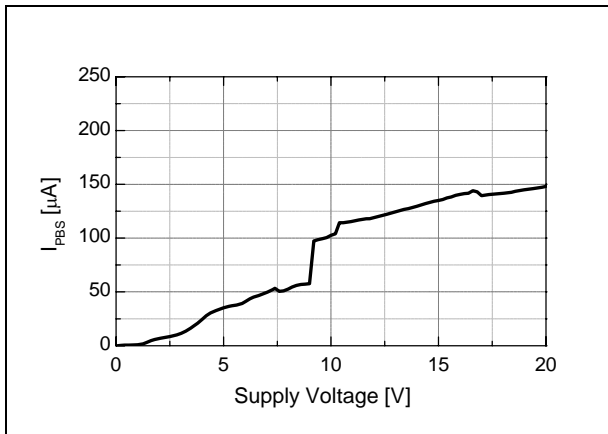


Figure 28.  $V_{BS}$  Operating Current vs. Supply Voltage

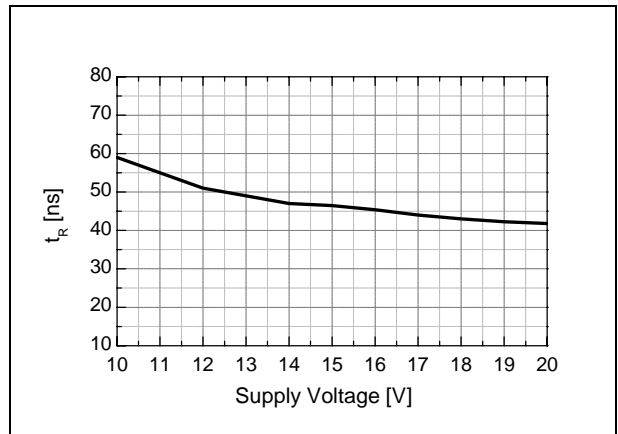
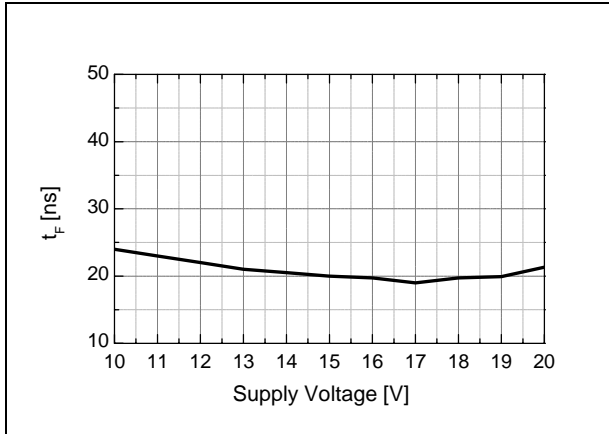
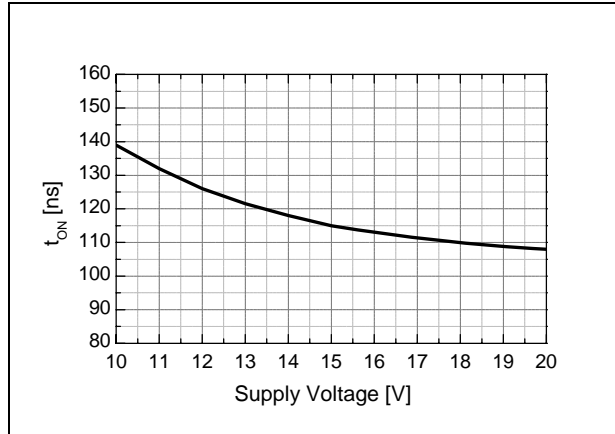


Figure 29. Rising Time vs. Supply Voltage

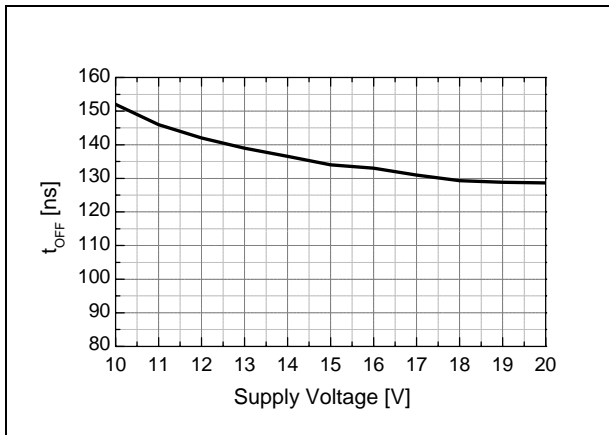
**Typical Characteristics** (Continued)



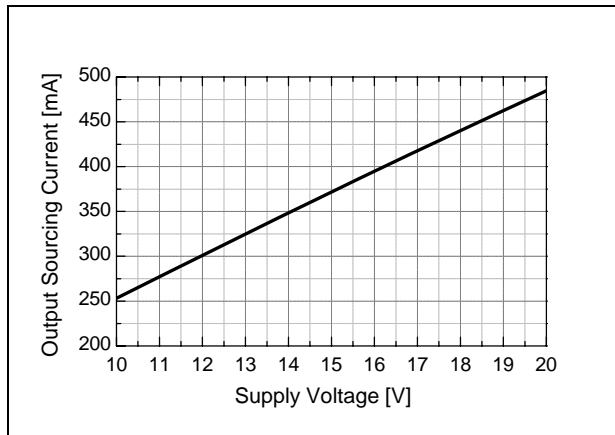
**Figure 30. Falling Time vs. Supply Voltage**



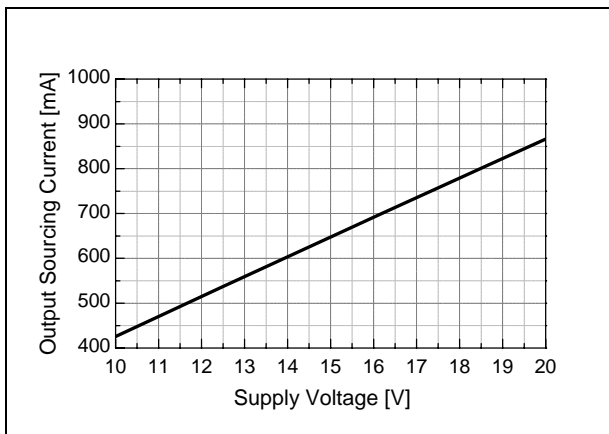
**Figure 31. Turn-On Delay Time vs. Supply Voltage**



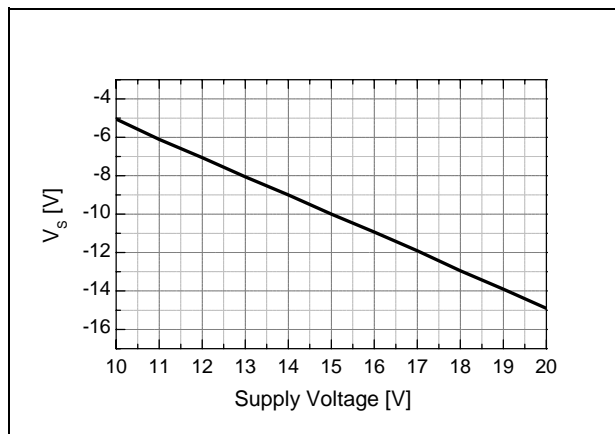
**Figure 32. Turn-Off Delay Time vs. Supply Voltage**



**Figure 33. Output Source Current vs. Supply Voltage**



**Figure 34. Output Sink Current vs. Supply Voltage**



**Figure 35. Allowable Negative  $V_S$  Voltage for Signal Propagation to High Side vs. Supply Voltage**

### Switching Time Definitions

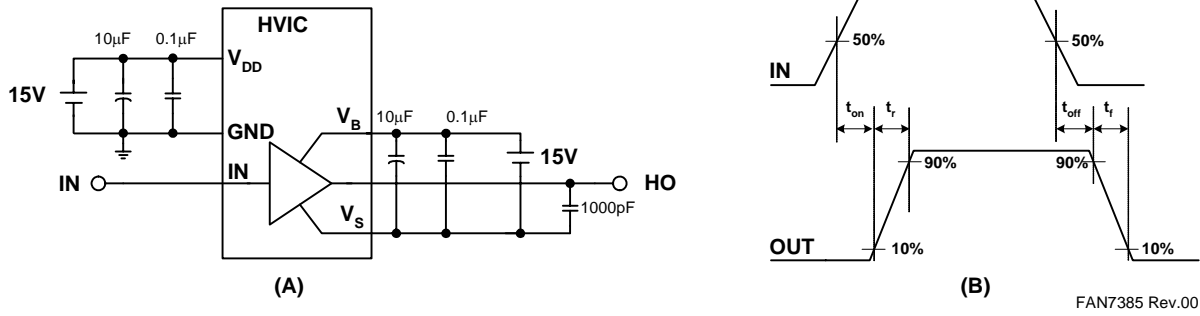


Figure 36. Switching Time Test Circuit

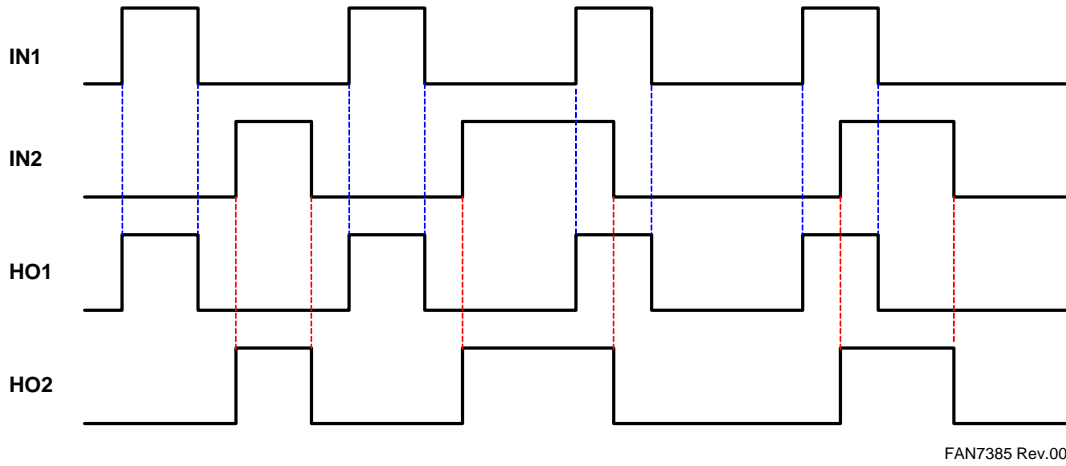


Figure 37. Input / Output Waveforms

## Typical Application Information

### 1. Under-Voltage Lockout (UVLO)

The FAN7385 has an under-voltage lockout (UVLO) protection circuit to prevent malfunction when  $V_{BS1}$  and  $V_{BS2}$  are lower than the specified threshold voltage. The UVLO circuit monitors the bootstrap capacitor voltages ( $V_{BS1}$ ,  $V_{BS2}$ ) independently.

### 2. Layout Consideration

For optimum performance, considerations must be given during printed circuit board (PCB) layout.

#### 2.1 Supply Capacitors

If the output stages are able to quickly turn on a switching device with a high current value, the supply capacitors must be placed as close as possible to the device pins ( $V_{DD}$  and GND for the ground-tied supply,  $V_B$  and  $V_S$  for the floating supply) to minimize parasitic inductance and resistance.

#### 2.2 Gate Drive Loop

Current loops behave like antennae, able to receive and transmit noise. To reduce the noise coupling/emission and improve the power switch turn-on and off performances, gate drive loops must be reduced as much as possible.

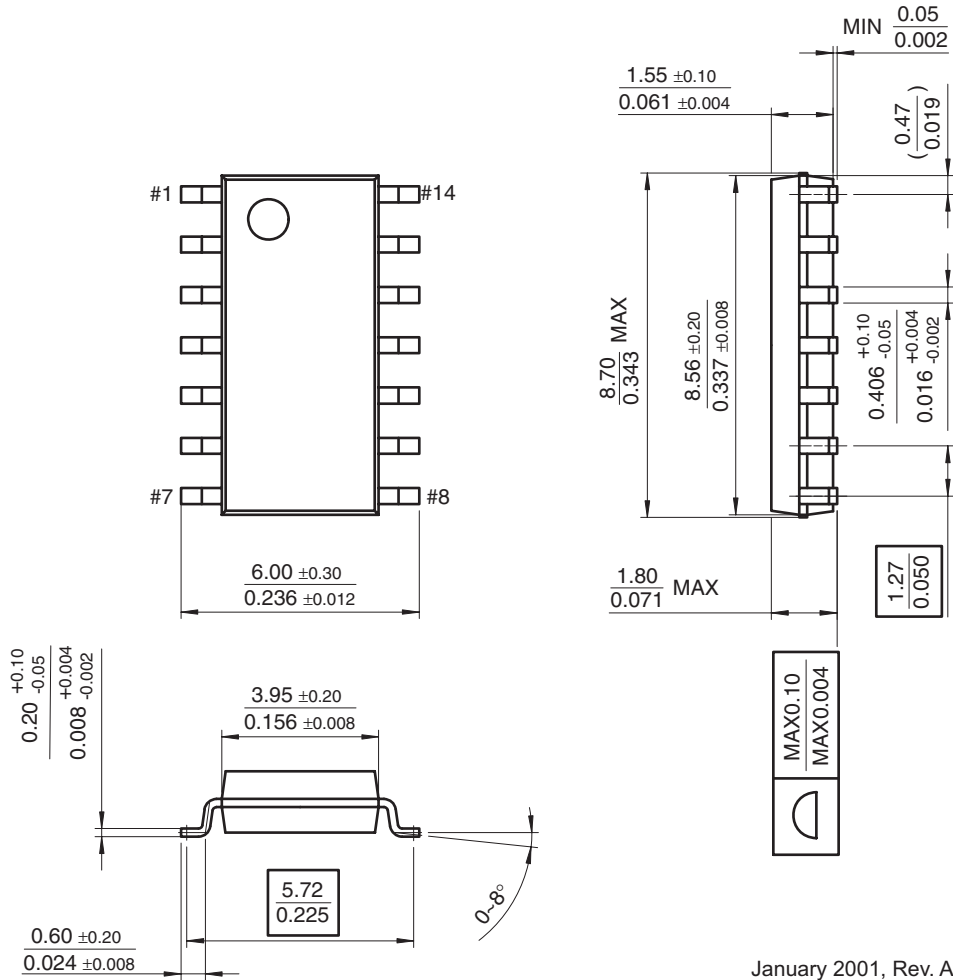
#### 2.3 Ground Plane

To minimize noise coupling, avoid placing the ground plane under or near the high-voltage floating side.

### Package Dimensions

#### 14-SOP

Dimensions are in millimeters unless otherwise noted.




January 2001, Rev. A  
14sop225b\_dim.pdf

Figure 38. 14-Lead Small Outline Package (SOP)



**TRADEMARKS**

The following are registered and unregistered trademarks Fairchild Semiconductor owns or is authorized to use and is not intended to be an exhaustive list of all such trademarks.

ACE <sup>x</sup>	HiSeC <sup>TM</sup>	PowerTrench <sup>®</sup>	TinyLogic <sup>®</sup>
Across the board. Around the world. <sup>TM</sup>	<i>i-Lo</i> <sup>TM</sup>	Programmable Active Droop <sup>TM</sup>	TINYOPTO <sup>TM</sup>
ActiveArray <sup>TM</sup>	ImpliedDisconnect <sup>TM</sup>	QFET <sup>®</sup>	TinyPower <sup>TM</sup>
Bottomless <sup>TM</sup>	IntelliMAX <sup>TM</sup>	QS <sup>TM</sup>	TinyWire <sup>TM</sup>
Build it Now <sup>TM</sup>	ISOPLANAR <sup>TM</sup>	QT Optoelectronics <sup>TM</sup>	TruTranslation <sup>TM</sup>
CoolFET <sup>TM</sup>	MICROCOUPLER <sup>TM</sup>	Quiet Series <sup>TM</sup>	μSerDes <sup>TM</sup>
CROSSVOLT <sup>TM</sup>	MicroPak <sup>TM</sup>	RapidConfigure <sup>TM</sup>	UHC <sup>®</sup>
CTL <sup>TM</sup>	MICROWIRE <sup>TM</sup>	RapidConnect <sup>TM</sup>	UniFET <sup>TM</sup>
Current Transfer Logic <sup>TM</sup>	MSX <sup>TM</sup>	ScalarPump <sup>TM</sup>	VCX <sup>TM</sup>
DOME <sup>TM</sup>	MSXPro <sup>TM</sup>	SMART START <sup>TM</sup>	Wire <sup>TM</sup>
E <sup>2</sup> C <sup>MOS</sup> <sup>TM</sup>	OCX <sup>TM</sup>	SPM <sup>®</sup>	
EcoSPARK <sup>®</sup>	OCXPro <sup>TM</sup>	SuperFET <sup>TM</sup>	
EnSigna <sup>TM</sup>	OPTOLOGIC <sup>®</sup>	SuperSOT <sup>TM</sup> -3	
FACT Quiet Series <sup>TM</sup>	OPTOPLANAR <sup>®</sup>	SuperSOT <sup>TM</sup> -6	
FACT <sup>®</sup>	PACMAN <sup>TM</sup>	SuperSOT <sup>TM</sup> -8	
FAST <sup>®</sup>	POP <sup>TM</sup>	TCM <sup>TM</sup>	
FASTr <sup>TM</sup>	Power220 <sup>®</sup>	The Power Franchise <sup>®</sup>	
FPS <sup>TM</sup>	Power247 <sup>®</sup>	 <sup>TM</sup>	
FRFET <sup>®</sup>	PowerEdge <sup>TM</sup>	TinyBoost <sup>TM</sup>	
GlobalOptoisolator <sup>TM</sup>	PowerSaver <sup>TM</sup>	TinyBuck <sup>TM</sup>	
GTO <sup>TM</sup>			

**DISCLAIMER**

FAIRCHILD SEMICONDUCTOR RESERVES THE RIGHT TO MAKE CHANGES WITHOUT FURTHER NOTICE TO ANY PRODUCTS HEREIN TO IMPROVE RELIABILITY, FUNCTION OR DESIGN. FAIRCHILD DOES NOT ASSUME ANY LIABILITY ARISING OUT OF THE APPLICATION OR USE OF ANY PRODUCT OR CIRCUIT DESCRIBED HEREIN; NEITHER DOES IT CONVEY ANY LICENSE UNDER ITS PATENT RIGHTS, NOR THE RIGHTS OF OTHERS. THESE SPECIFICATIONS DO NOT EXPAND THE TERMS OF FAIRCHILD'S WORLDWIDE TERMS AND CONDITIONS, SPECIFICALLY THE WARRANTY THEREIN, WHICH COVERS THESE PRODUCTS.

**LIFE SUPPORT POLICY**

FAIRCHILD'S PRODUCTS ARE NOT AUTHORIZED FOR USE AS CRITICAL COMPONENTS IN LIFE SUPPORT DEVICES OR SYSTEMS WITHOUT THE EXPRESS WRITTEN APPROVAL OF FAIRCHILD SEMICONDUCTOR CORPORATION.

As used herein:

- Life support devices or systems are devices or systems which, (a) are intended for surgical implant into the body or (b) support or sustain life, and (c) whose failure to perform when properly used in accordance with instructions for use provided in the labeling, can be reasonably expected to result in a significant injury of the user.
- A critical component in any component of a life support, device, or system whose failure to perform can be reasonably expected to cause the failure of the life support device or system, or to affect its safety or effectiveness.

**PRODUCT STATUS DEFINITIONS**

**Definition of Terms**

Datasheet Identification	Product Status	Definition
Advance Information	Formative or In Design	This datasheet contains the design specifications for product development. Specifications may change in any manner without notice.
Preliminary	First Production	This datasheet contains preliminary data; supplementary data will be published at a later date. Fairchild Semiconductor reserves the right to make changes at any time without notice to improve design.
No Identification Needed	Full Production	This datasheet contains final specifications. Fairchild Semiconductor reserves the right to make changes at any time without notice to improve design.
Obsolete	Not In Production	This datasheet contains specifications on a product that has been discontinued by Fairchild Semiconductor. The datasheet is printed for reference information only.

Rev. I23



ON Semiconductor and  are trademarks of Semiconductor Components Industries, LLC dba ON Semiconductor or its subsidiaries in the United States and/or other countries. ON Semiconductor owns the rights to a number of patents, trademarks, copyrights, trade secrets, and other intellectual property. A listing of ON Semiconductor's product/patent coverage may be accessed at [www.onsemi.com/site/pdf/Patent-Marking.pdf](http://www.onsemi.com/site/pdf/Patent-Marking.pdf). ON Semiconductor reserves the right to make changes without further notice to any products herein. ON Semiconductor makes no warranty, representation or guarantee regarding the suitability of its products for any particular purpose, nor does ON Semiconductor assume any liability arising out of the application or use of any product or circuit, and specifically disclaims any and all liability, including without limitation special, consequential or incidental damages. Buyer is responsible for its products and applications using ON Semiconductor products, including compliance with all laws, regulations and safety requirements or standards, regardless of any support or applications information provided by ON Semiconductor. "Typical" parameters which may be provided in ON Semiconductor data sheets and/or specifications can and do vary in different applications and actual performance may vary over time. All operating parameters, including "Typicals" must be validated for each customer application by customer's technical experts. ON Semiconductor does not convey any license under its patent rights nor the rights of others. ON Semiconductor products are not designed, intended, or authorized for use as a critical component in life support systems or any FDA Class 3 medical devices or medical devices with a same or similar classification in a foreign jurisdiction or any devices intended for implantation in the human body. Should Buyer purchase or use ON Semiconductor products for any such unintended or unauthorized application, Buyer shall indemnify and hold ON Semiconductor and its officers, employees, subsidiaries, affiliates, and distributors harmless against all claims, costs, damages, and expenses, and reasonable attorney fees arising out of, directly or indirectly, any claim of personal injury or death associated with such unintended or unauthorized use, even if such claim alleges that ON Semiconductor was negligent regarding the design or manufacture of the part. ON Semiconductor is an Equal Opportunity/Affirmative Action Employer. This literature is subject to all applicable copyright laws and is not for resale in any manner.

## PUBLICATION ORDERING INFORMATION

### LITERATURE FULFILLMENT:

Literature Distribution Center for ON Semiconductor  
19521 E. 32nd Pkwy, Aurora, Colorado 80011 USA  
**Phone:** 303-675-2175 or 800-344-3860 Toll Free USA/Canada  
**Fax:** 303-675-2176 or 800-344-3867 Toll Free USA/Canada  
**Email:** [orderlit@onsemi.com](mailto:orderlit@onsemi.com)

**N. American Technical Support:** 800-282-9855 Toll Free  
USA/Canada  
**Europe, Middle East and Africa Technical Support:**  
Phone: 421 33 790 2910  
**Japan Customer Focus Center**  
Phone: 81-3-5817-1050

**ON Semiconductor Website:** [www.onsemi.com](http://www.onsemi.com)  
**Order Literature:** <http://www.onsemi.com/orderlit>  
For additional information, please contact your local  
Sales Representative