

EMILY-SS-WAS

~8° beam for wall-washing. 14.83 mm high lens.

TECHNICAL SPECIFICATIONS:

Dimensions	Ø 26.0 mm
Height	14.8 mm
Fastening	tape, pin
Colour	clear
Box size	480 x 280 x 300 mm
Box weight	11.4 kg
Quantity in Box	1690 pcs
ROHS compliant	yes ⓘ



MATERIAL SPECIFICATIONS:

Component	Type	Material	Colour
EMILY-SS-WAS	Lens	PMMA	clear
SPUTNIK-TAPE	Tape	PU tape	black

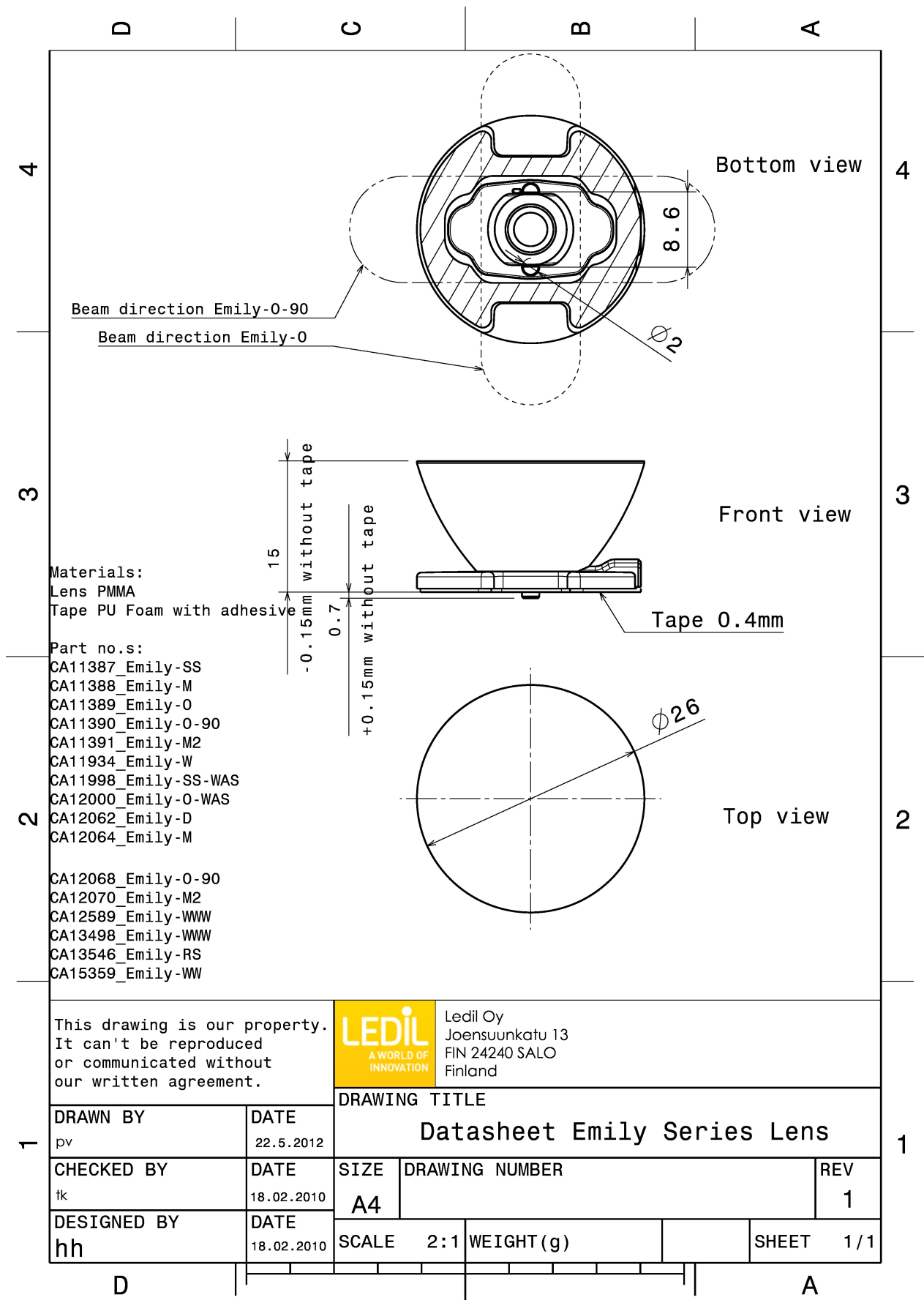

This drawing is our property. It can't be reproduced or communicated without our written agreement.

LEDiL
A WORLD OF INNOVATION

Ledil Oy
Joensuunkatu 13
FIN 24240 SALO
Finland

DRAWN BY pv		DATE 22.5.2012	DRAWING TITLE Datasheet Emily Series Lens		
CHECKED BY tk	DATE 18.02.2010	SIZE A4	DRAWING NUMBER		REV 1
DESIGNED BY hh	DATE 18.02.2010	SCALE 2:1	WEIGHT (g)	SHEET 1/1	

PHOTOMETRIC DATA (MEASURED):



LED XHP35 HD
 FWHM Asymmetric
 Efficiency 91 %
 Peak intensity 7.600 cd/lm
 Required components:

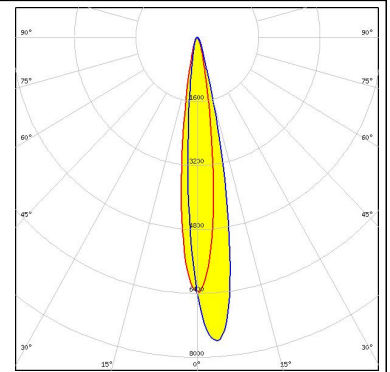

LED XM-L
 FWHM Asymmetric
 Efficiency 94 %
 Peak intensity 9.800 cd/lm
 Required components:

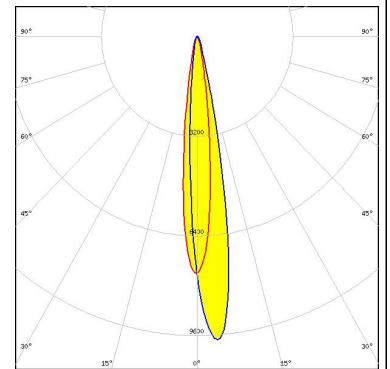

LED XM-L RGB
 FWHM Asymmetric
 Efficiency 93 %
 Peak intensity 6.500 cd/lm
 Required components:

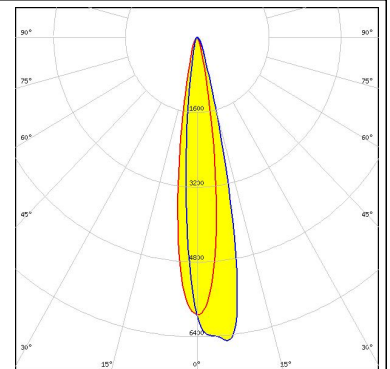

LED XM-L2
 FWHM Asymmetric
 Efficiency 88 %
 Peak intensity 10.500 cd/lm
 Required components:

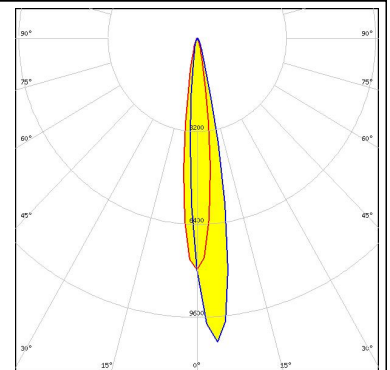

PHOTOMETRIC DATA (MEASURED):



LED XP-E
FWHM 10.0°
Efficiency 92 %
Peak intensity 18.300 cd/Im
Required components:

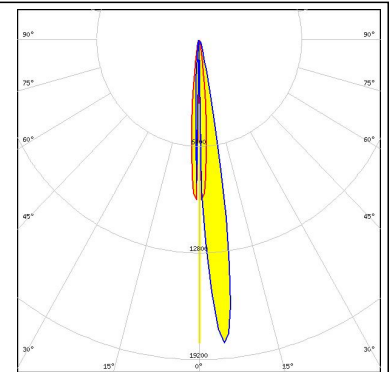

LED XP-G
FWHM 11.0°
Efficiency 93 %
Peak intensity 11.920 cd/Im
Required components:

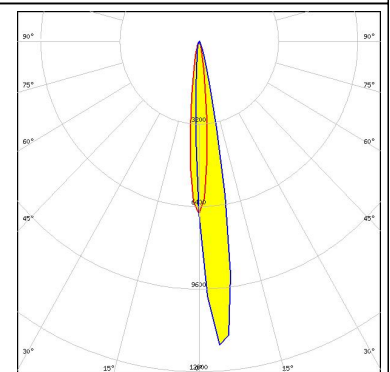

LED XP-L HI
FWHM Asymmetric
Efficiency 91 %
Peak intensity 14.600 cd/Im
Required components:

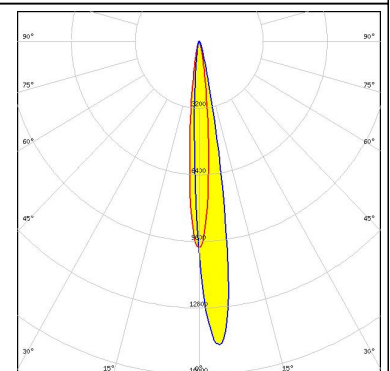
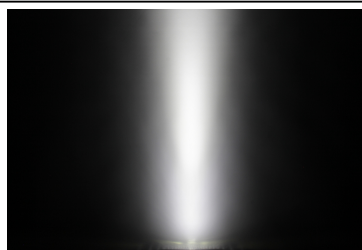

LED LUXEON A
FWHM 12.0°
Efficiency %
Peak intensity 10.280 cd/Im
Required components:

PHOTOMETRIC DATA (MEASURED):

LUMILEDS

LED LUXEON Rebel
 FWHM 8.0°
 Efficiency 88 %
 Peak intensity 11.600 cd/lm
 Required components:

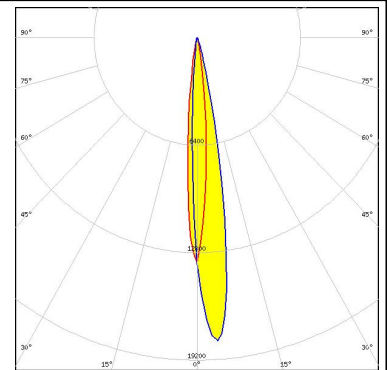

LUMILEDS

LED LUXEON Rebel ES
 FWHM 12.0°
 Efficiency 91 %
 Peak intensity 9.950 cd/lm
 Required components:

LUMILEDS

LED LUXEON T
 FWHM 11.0°
 Efficiency 89 %
 Peak intensity 14.000 cd/lm
 Required components:

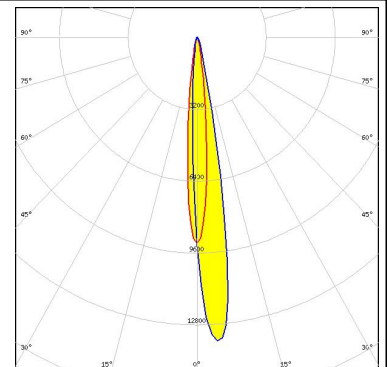
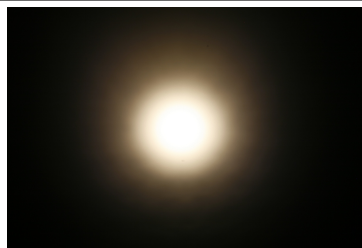

LUMILEDS

LED LUXEON TX
 FWHM Asymmetric
 Efficiency 88 %
 Peak intensity 14.800 cd/lm
 Required components:

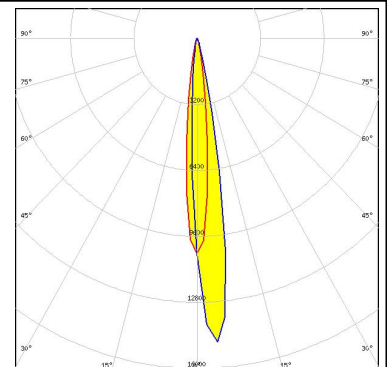
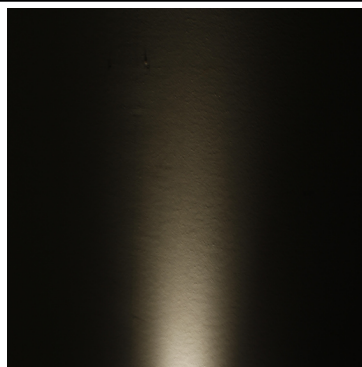

PHOTOMETRIC DATA (MEASURED):



LED NCSxx19B
FWHM 11.0°
Efficiency 89 %
Peak intensity 15.500 cd/lm
Required components:

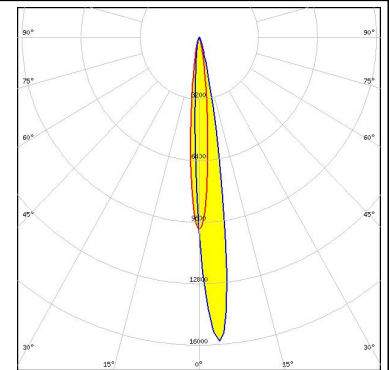
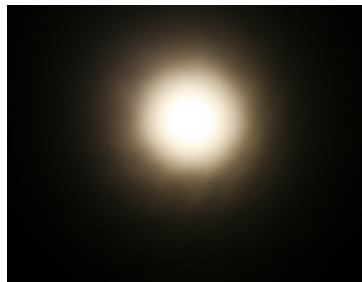

LED NVSxx19A
FWHM 13.0°
Efficiency 89 %
Peak intensity 8.030 cd/lm
Required components:



LED NVSxx19B/NVSxx19C
FWHM Asymmetric
Efficiency 93 %
Peak intensity 12.100 cd/lm
Required components:

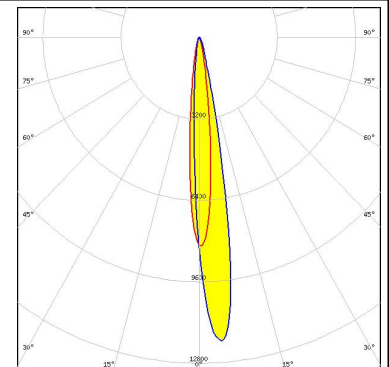

LED Oslon SSL 150
FWHM 11.0°
Efficiency 88 %
Peak intensity 14.870 cd/lm
Required components:

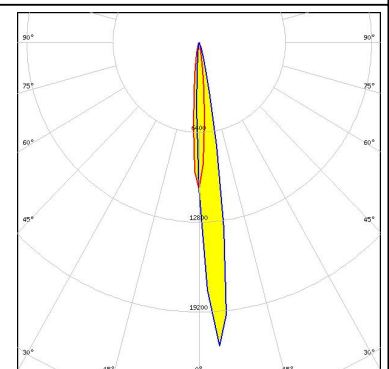

PHOTOMETRIC DATA (MEASURED):

OSRAM
Opto Semiconductors

LED Oslon SSL 80
FWHM 11.0°
Efficiency 91 %
Peak intensity 10.980 cd/lm
Required components:

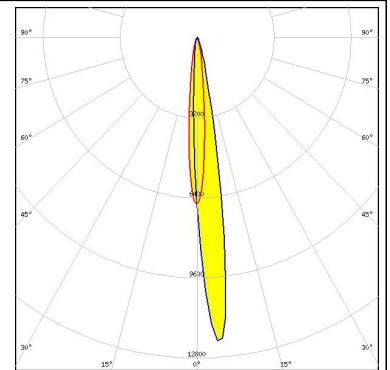

SEKUL
SEOUL SEMICONDUCTOR

LED Z5M1/Z5M2
FWHM Asymmetric
Efficiency 88 %
Peak intensity 15.200 cd/lm
Required components:

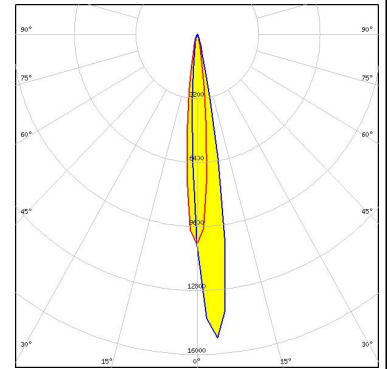

PHOTOMETRIC DATA (SIMULATED):



LED LUXEON H50-2
FWHM Asymmetric
Efficiency 92 %
Peak intensity 13.400 cd/lm
Required components:

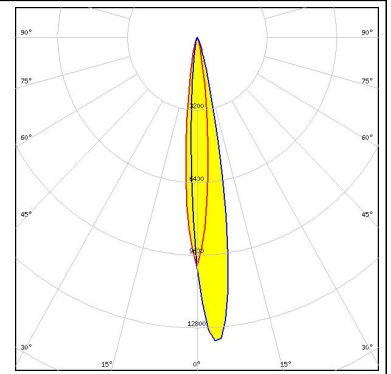

GENERAL INFORMATION:

NOTE: The typical beam angle will be changed by different color, chip size and chip position tolerance. The typical total beam angle is the full angle measured where the luminous intensity is half of the peak value.

MATERIALS:

As part of our continuous research and improvement processes, and to ensure the best possible quality and availability of our products, LEDiL reserves the right to change material grades without notice.

PRODUCT DATA USER AGREEMENT AND DISCLAIMER:

The measured data in the provided downloadable LEDiL Product Datasheets and Mechanical 2D-Drawings is rounded and provided as reference for planning. LEDiL Oy's optical specifications have been verified by conducting performance testing of the products in accordance with the company's quality system. The reported data are averaged results of multiple measurements with typical variation. LEDiL Oy reserves the right to without prior notification make changes and improvements to its products.

LEDiL Oy assumes neither warranty, nor guarantee nor any other liability of any kind for the contents and correctness of the provided data. The provided data has been generated with highest diligence but the provided data may in reality not represent the complete possible variation range of all intrinsic parameters. Therefore, in certain cases a deviation from the provided data could occur.

LEDiL Oy reserves the right to undertake technical changes of its products without further notification which could lead to changes in the provided data. LEDiL Oy assumes no liability of any kind for the possible deviation from any provided data or any other damage resulting from the usage of the provided data.

The user agrees to this disclaimer and user agreement with the download or usage of the provided files.

LEDiL Oy

Joensuunkatu 13
FI-24240 SALO
Finland

LEDiL Inc.

228 West Page Street
Suite D
Sycamore IL 60178
USA

Local sales and technical support

[www.ledil.com/
where_to_buy](http://www.ledil.com/where_to_buy)

Shipping locations

Salo, Finland
Hong Kong, China

Distribution Partners

[www.ledil.com/
where_to_buy](http://www.ledil.com/where_to_buy)