

REVISIONS					
REV	ECO	DESCRIPTION	DATE	BY	APPR
B1	-	RELEASED DRAWING	JUN-25-2014	BEN	TOMMY

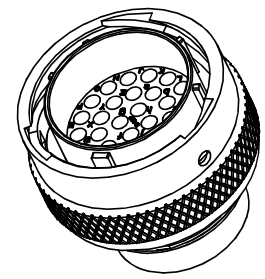
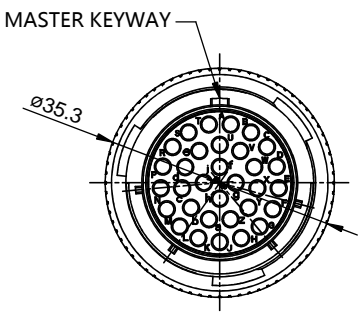
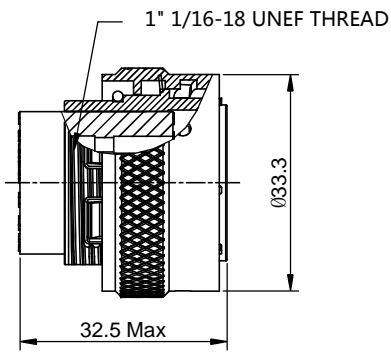

NOTES : (UNLESS OTHERWISE SPECIFIED)

1. MATERIAL :
 - SHELL : ZINC ALLOY , NICKEL PLATED.
 - INSERT : THERMOPLASTIC , UL94 V-0.
 - COUPLING NUT : AL ALLOY , NICKEL PLATED.
 - WAVE WASHER : STAINLESS STEEL.
 - O-RING : NBR.
2. SPECIFICATIONS :
 - 2.1 RATED CURRENT :
 - 2.1.1 STAMPED CONTACT : 5A (MAX) .
 - 2.1.2 MACHINED CONTACT : 7.5A (MAX) .
 - 2.2 RATED VOLTAGE : 150V (AC/DC) .
 - 2.3 OPERATING TEMPERATURE : -40°C ~ +105°C.
 - 2.4 DIELECTRIC WITHSTANDING VOLTAGE : LESS THAN 2 MILLIAMPS CURRENT LEAKAGE@1500 VOLTS AC.
 - 2.5 INSULATION RESISTANCE : 5000 MEGOHMS MIN.
 - 2.6 IP--CLASS : IP67.
 - 2.7 MATING CYCLES DURABILITY : 500 CYCLES MIN.
 - 2.8 ROHS COMPLIANT.
3. SUITABLE CONTACTS : 20# CONTACTS.
4. ALL DIMENSIONS ARE FOR REFERENCE USE ONLY.

KEY POS	PART NUMBER
N	RT0W61832PNH
W	RT0W61832PWH
X	RT0W61832PXH
Y	RT0W61832PYH
Z	RT0W61832PZH

QUANTITY	SEE PART NUMBER CHART	DESCRIPTION	ITEM
MATERIALS LIST			
<small>UNLESS OTHERWISE SPECIFIED</small> 1) All dimensions are in metric(mm). 2) Tolerances are as follows: 1 PL DEC ±0.30 Fractions ±1/64 2 PL DEC ±0.15 Angles ±1° 3 PL DEC ±0.08 3) Note reference =		SIGNATURES DRAWN: BEN CHECKED: ENGINEER: APPROVAL:	DATE JUN-25-2014
<small>MATERIAL SPECIFICATIONS:</small> CUSTOMER:		 Sine Systems - www.amphenol-sine.com 44724 Morley Drive Clinton Township, MI 48036	
<small>PROCESS SPECIFICATIONS:</small> THIS DRAWING IS SUPPLIED FOR INFORMATION ONLY. DESIGN FEATURES, SPECIFICATIONS AND PERFORMANCE DATA SHOWN HEREON ARE THE PROPERTY OF THE AMPHENOL CORPORATION. NO RIGHTS OF REPRODUCTION ARE IMPLIED. ALL DIMENSIONS ARE SUBJECT TO NORMAL MANUFACTURING VARIATIONS.		<small>SIZE</small> B C-	<small>DWG NO.</small> RT0W61832P*H
<small>NEXT ASSY:</small>		<small>SCALE</small> NONE	<small>REVISION</small> B1
			<small>SHEET</small> 1 <small>OF</small> 1

TITLE: ECO-MATE PLUG, SIZE 18,32POS,PIN
 DWG NO.: RT0W61832P*H
 REV: B1
 SH: 1
 OF: 1