

Assembly Instructions for - 37315

Folded Short Partition

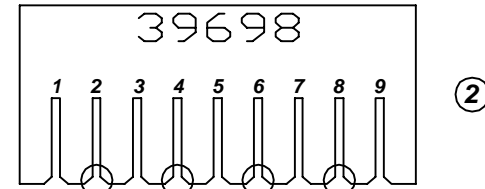

Use only the circled slots for partition assembly

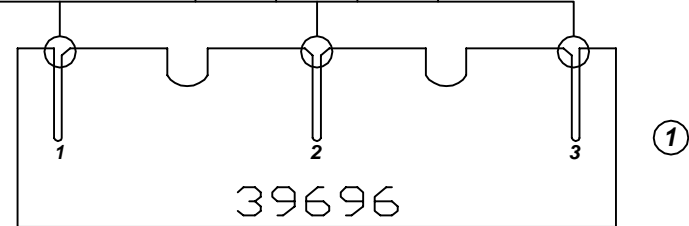

Folded Long Partition

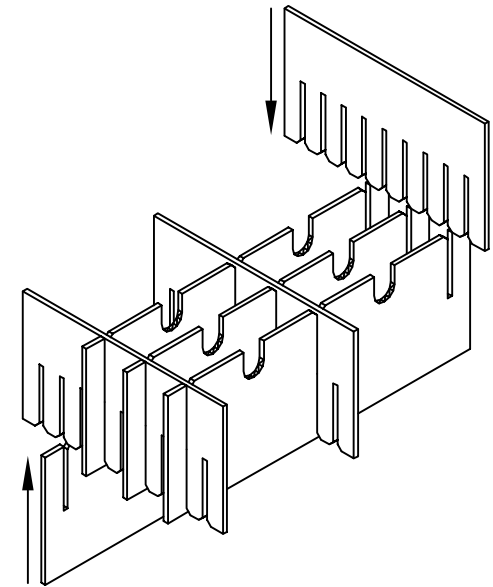
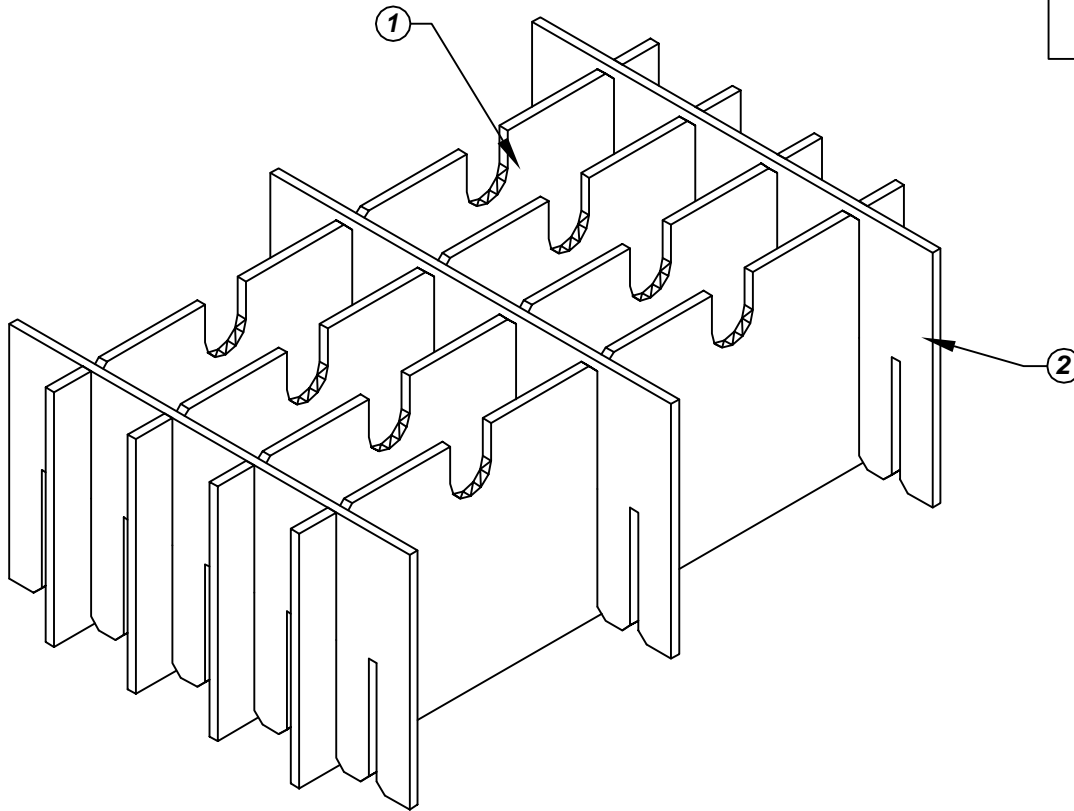

Made in America

F/N ①	Part # 39696	Dimensions: 13-3/4" x 18-1/2"	Description: 456/458 - LP Long Partition	Qty: 4
F/N ②	Part # 39698	Dimensions: 13-3/4" x 12-1/4"	Description: 456 - SP Short Partition	Qty: 3

37315 - 10 Cell Inplant Handler Cell Size - 6-3/4" x 7-3/4" x 2-1/4"

Notes:
For use with the following storage container & lid:
37520 - Storage Container
37553 - Lid

PROTEKTIVE PAK
13520 MONTE VISTA AVENUE, CHINO, CA 91710
PHONE (909) 627-2578, FAX (909) 363-7331
ProtektivePak.com



DRAWING NUMBER
IPH-37315

DATE
Dec.
2007