

ISL8002xDEMO1Z and ISL80019xDEMO1Z Demonstration Board User Guide

Description

The ISL8002, ISL80019, ISL8002A, ISL8002D and ISL80019A DEMO1Z kits are intended for use by individuals with requirements for Point-of-Load applications sourcing from 2.7V to 5.5V. The ISL8002DEMO1Z and ISL80019DEMO1Z boards are used to demonstrate the performance of the ISL8002 and ISL80019 low quiescent current mode converters.

The ISL8002 and ISL8019 are offered in a 8 pin 2mmx2mm TDFN package with 1mm maximum height. The complete converter occupies less than 64mm² area.

TABLE 1. KEY DIFFERENCES BETWEEN FAMILY OF PARTS

PART#	I _{OUT} (MAX) (A)	F _{SW} (MHz)	V _{IN} RANGE (V)	V _{OUT} RANGE (V)	PACKAGE SIZE
ISL80019	1.5	1	2.7 to 5.5	0.6 to 5.5	8 pin 2mmx2mm TDFN
ISL80019A	1.5	2			
ISL8002	2	1			
ISL8002A	2	2			
ISL8002D	2	2			

Key Features

- High efficiency synchronous buck regulator with up to 95% efficiency
- 0.8% reference accuracy over temperature/load/line
- Start-up with prebiased output
- Internal soft-start - 1ms
- Soft-stop output discharge during disable
- 1MHz, 2MHz default frequency
- Negative OC protection

Ordering Information

PART NUMBER	DESCRIPTION
ISL8002DEMO1Z	Switching frequency 1MHz; Output current: 2A; PG rising /falling delay time: 1ms/15µs
ISL8002ADEMO1Z	Switching frequency 2MHz; Output current: 2A; PG rising /falling delay time: 1ms/15µs
ISL80019DEMO1Z	Switching frequency 1MHz ; Output current: 1.5A; PG rising /falling delay time: 1ms/15µs
ISL80019ADEMO1Z	Switching frequency 2MHz; Output current: 1.5A; PG rising /falling delay time: 1ms/15µs
ISL8002DDEMO1Z	Switching frequency 2MHz; Output current: 2A; PG rising /falling delay time: 390µs/330µs

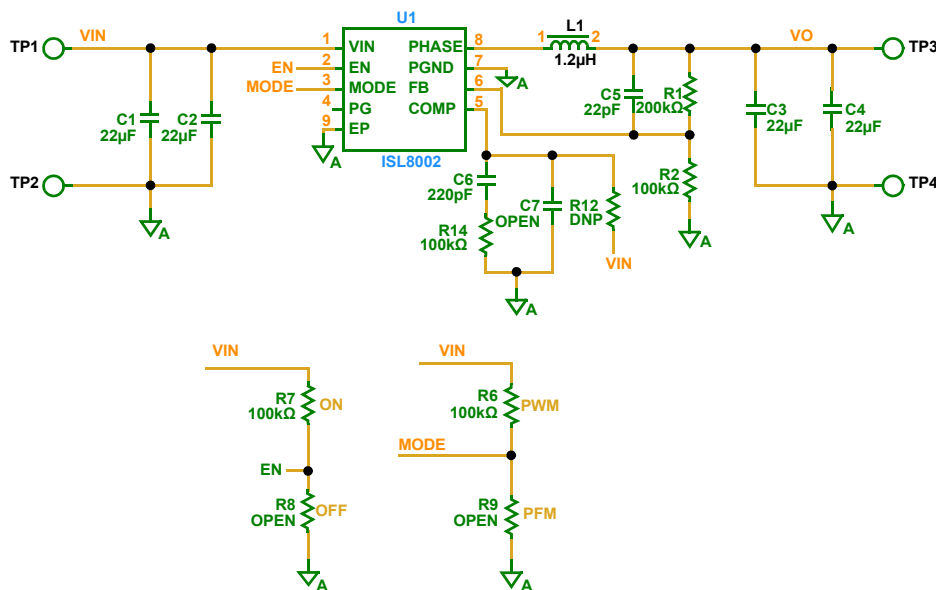

FIGURE 1. ISL8002DEMO1Z SCHEMATIC

ISL8002EVAL2Z Evaluation Board

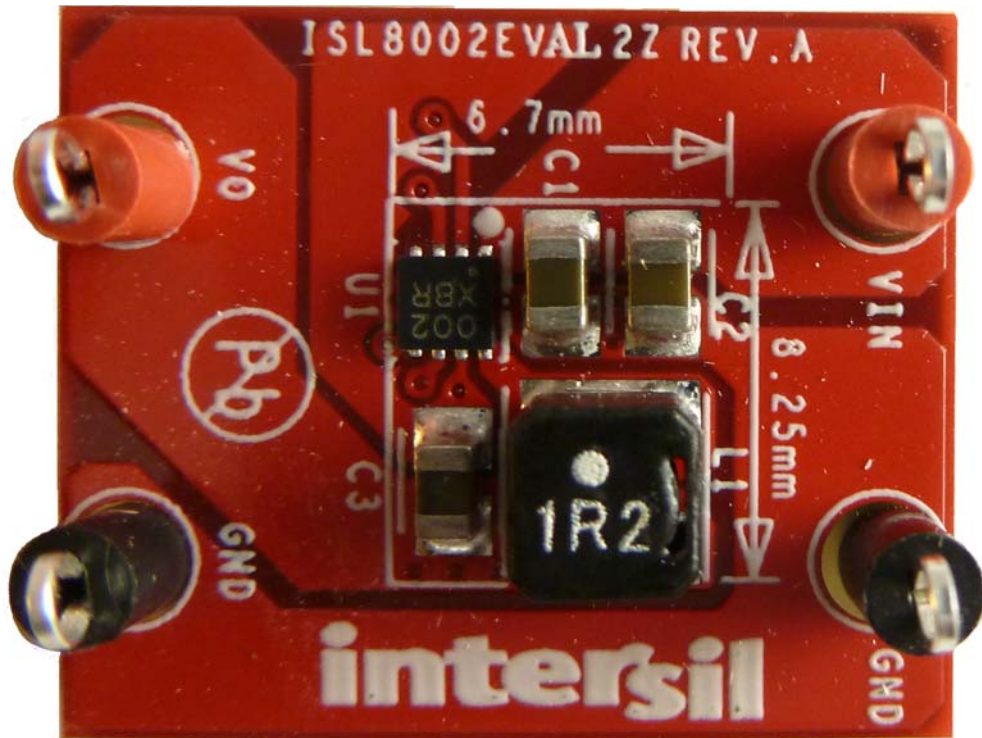

FIGURE 2. TOP SIDE

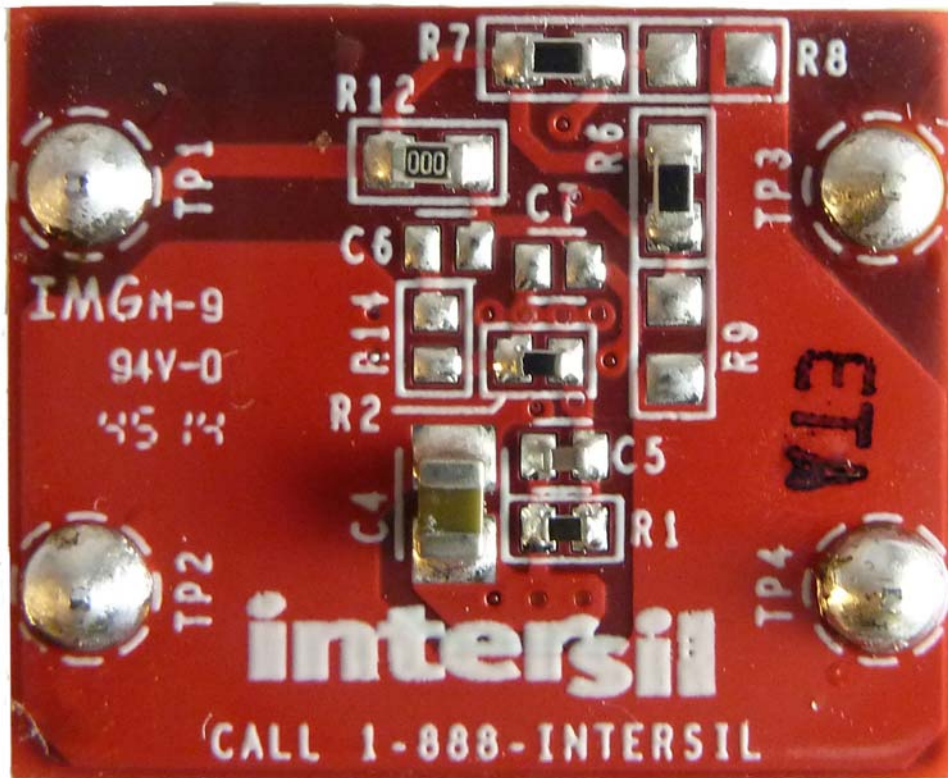

FIGURE 3. BOTTOM SIDE

Quick Setup Guide

1. Ensure that the circuit is correctly connected to the supply and loads prior to applying any power.
2. Connect the bias supply to V_{IN} . Plus terminal to V_{IN} (TP1) and negative return to PGND (TP2).
3. Connect the output load to V_O (TP3), and the negative return to PGND (TP4).
4. Turn on the power supply.
5. Verify the output voltage is 1.8V for V_{OUT} .

Recommended Equipment

The following materials are recommended to perform testing:

- 0V to 10V power supply with at least 5A source current capability or 5V battery
- Electronic loads capable of sinking current up to 7A
- Digital Multimeters (DMMs)
- 100MHz quad-trace oscilloscope

Signal generator

PCB Layout Guidelines

The PCB layout is a very important converter design step to make sure the designed converter works well. The power loop is composed of the output inductor (L's), the output capacitor (COUT), the PHASE's pin and the PGND pin. It is necessary to make the power loop as small as possible and the connecting traces among them should be direct, short and wide. The switching node of the converter, the PHASE pins, and the traces connected to the node are very noisy, so keep the voltage feedback trace away from these noisy traces. The input capacitor should be placed as closely as possible to the V_{IN} pin and the ground of the input and output capacitors should be connected as closely as possible. The heat of the IC is mainly dissipated through the thermal pad. Maximizing the copper area connected to the thermal pad is preferable. In addition, a solid ground plane is helpful for better EMI performance. It is recommended to add at least 4 vias ground connection within the pad for best thermal relief.

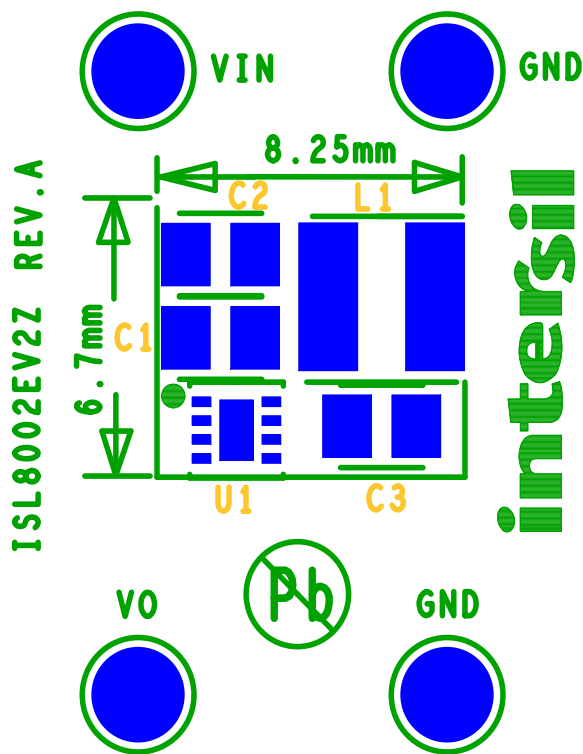

FIGURE 4. SILKSCREEN TOP

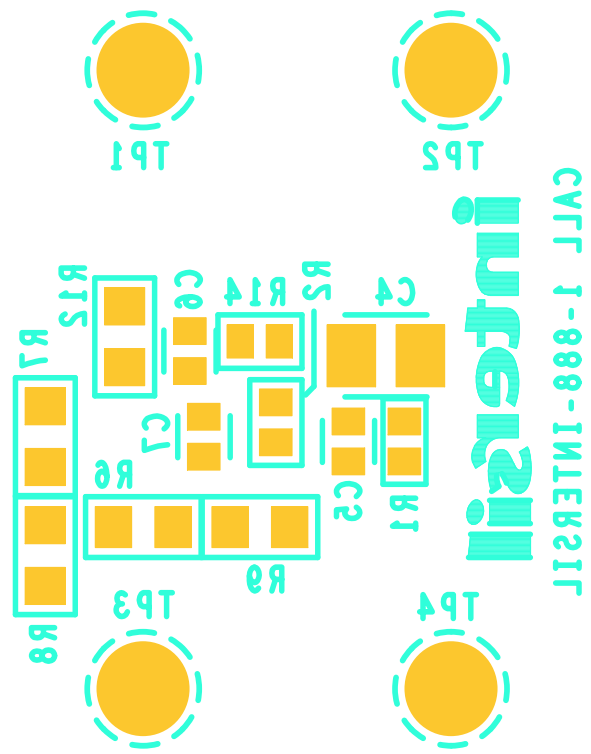

FIGURE 5. SILKSCREEN BOTTOM

Application Note 1817

TABLE 2. BILL OF MATERIALS

PART NUMBER	QTY	UNITS	REFERENCE DESIGNATOR	COMMENT	DESCRIPTION	MANUFACTURER	MANUFACTURER PART
H1044-00220-50V5-T	1	ea.	C5		CAP, SMD, 0402, 22pF, 50V, 5%, NPO	MURATA PANASONIC	GRM36COG220J050AQ ECU-E1H220JCQ
H1044-00221-50V5-T	1	ea.	C6		CAP, SMD, 0402, 220pF, 50V, 5%, COG	PANASONIC, TDK	ECU-E1H221JCQ C1005C0G1H221J
H1044-DNP	0	ea.	C7		CAP, SMD, 0402, DNP-PLACE HOLDER		
H1046-00226-6R3V10-T	4	ea.	C1, C2, C3, C4		CAP, SMD, 0805, 22µF, 6.3V, 10%, X5R, ROHS	JOHANSON DIELECTRICS INC	6R3R15X226KV4E JMK212B226KG-T
VLCF-4028T-1R2N2R7-2	1	ea.	L1 for ISL8002A, ISL80019A, 2MHz	COIL-PWR INDUCTOR, WW, SMD, 4mm, 1.2µH, 30%, 2.7A, ROHS	TDK	VLCF4028T-1R2N2R7-2	VLCF4028T-1R2N2R7-2
74437324022	1	ea.	L1 for ISL8002, ISL80019, 1MHz	COIL-PWR INDUCTOR, SMD, 4.45x4.6, 2.2µH, 20%, 3.25A, ROHS	Würth Electronics	74437324022	
ISL8002IRZ	1	ea.	U1		IC-2A BUCK REGULATOR, 8P, µTDFN, 2X2, ROHS	INTERSIL	ISL8002IRZ
H2510-01003-1/16W1-T	2	ea.	R2, R14		RES, SMD, 0402, 100kΩ, 1/16W, 1%	PANASONIC	ERJ2RKF1003
H2510-02003-1/16W1-T	1	ea.	R1		RES, SMD, 0402, 200kΩ, 1/16W, 1%	VISHAY/DALE, VENKEL	CRCW0402200KFKED CR0402-16W-2003FT
H2510-DNP	0	ea.	R12		RES, SMD, 0402, DNP		
H2511-01003-1/10W1-T	2	ea.	R6, R7		RES, SMD, 0603, 100kΩ, 1/10W, 1%	PANASONIC ROHM	ERJ-3EKF1003V MCR03EZPF1003
H2511-DNP	0	ea.	R8, R9		RES, SMD, 060 3, DNP-PLACE HOLDER		

Intersil Corporation reserves the right to make changes in circuit design, software and/or specifications at any time without notice. Accordingly, the reader is cautioned to verify that the Application Note or Technical Brief is current before proceeding.

For information regarding Intersil Corporation and its products, see www.intersil.com

Typical Performance Curves

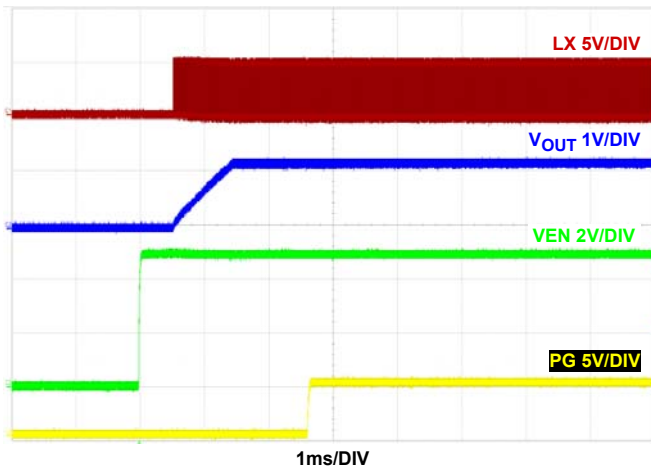

FIGURE 6. ISL8002A START-UP AT 2A LOAD $f_{SW} = 2\text{MHz}$, $V_{IN} = 5\text{V}$, MODE = PWM, $T_A = +25^\circ\text{C}$

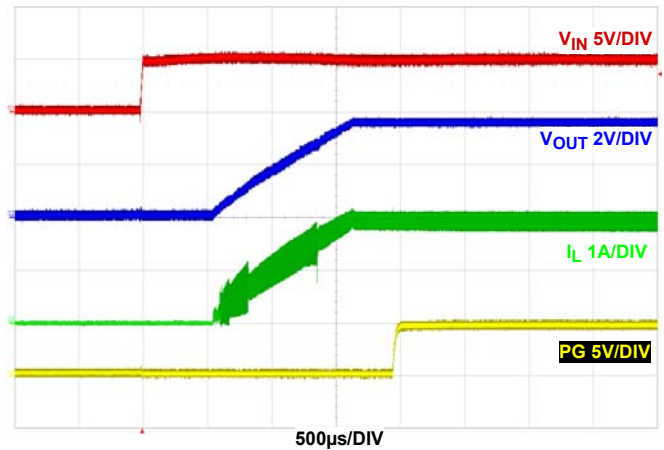

FIGURE 7. ISL8002D START-UP V_{IN} AT 2A LOAD $f_{SW} = 2\text{MHz}$, $V_{IN} = 5\text{V}$, MODE = PWM, $T_A = +25^\circ\text{C}$

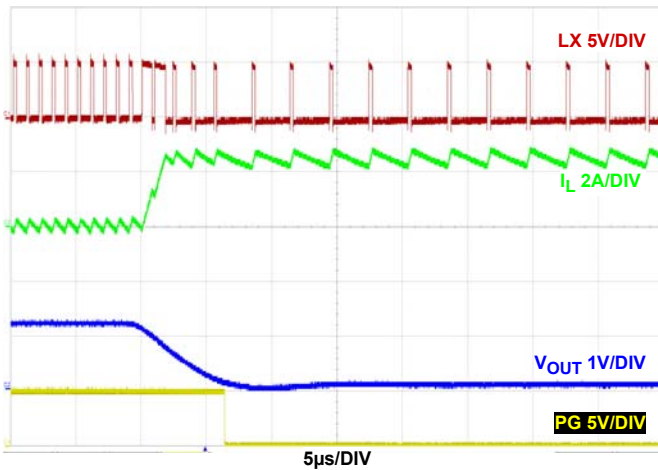

FIGURE 8. ISL8002A OUTPUT SHORT-CIRCUIT $f_{SW} = 2\text{MHz}$, $V_{IN} = 5\text{V}$, MODE = PFM, $T_A = +25^\circ\text{C}$

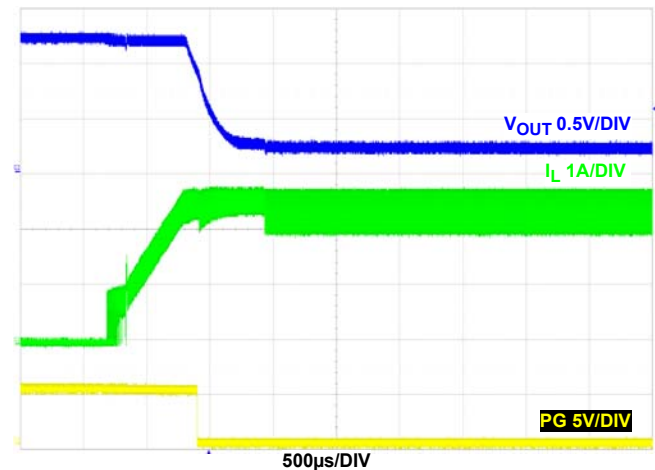

FIGURE 9. ISL8002A OVERCURRENT PROTECTION $f_{SW} = 2\text{MHz}$, $V_{IN} = 5\text{V}$, MODE = PWM, $T_A = +25^\circ\text{C}$

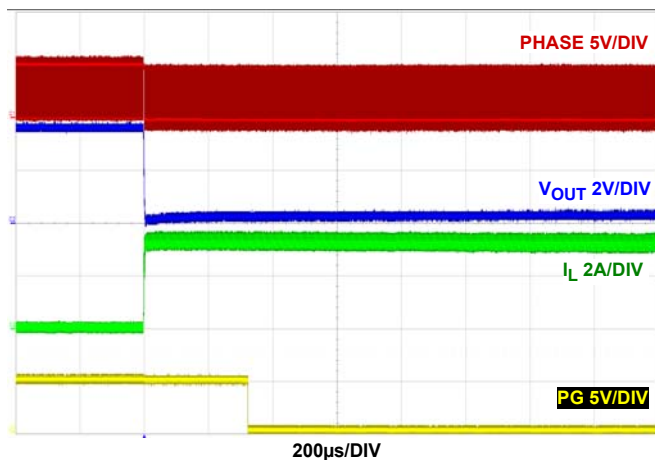

FIGURE 10. ISL8002D OUTPUT SHORT-CIRCUIT $f_{SW} = 2\text{MHz}$, $V_{IN} = 5\text{V}$, MODE = PFM, $T_A = +25^\circ\text{C}$

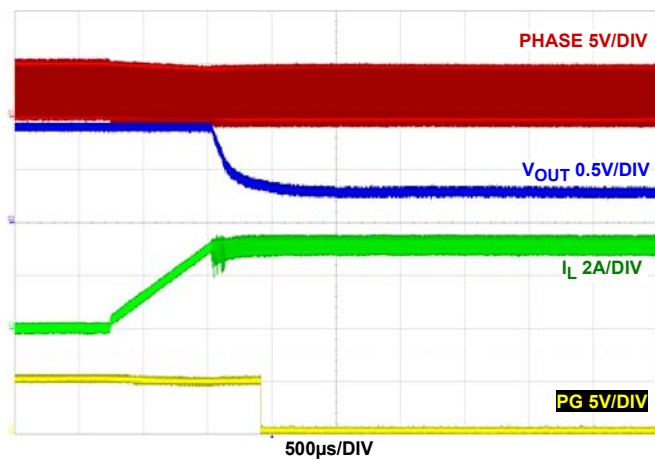

FIGURE 11. ISL8002D OVERCURRENT PROTECTION $f_{SW} = 2\text{MHz}$, $V_{IN} = 5\text{V}$, MODE = PWM, $T_A = +25^\circ\text{C}$