



**Muffin - MC12B3 - 032489 - No**  
 (Family) (Model) (Part #) (In Stock)

## Electrical Specifications

Operating Voltage:	12 Volts
Voltage Range:	6 - 14 Volts
Power Supply:	7.9 Watts
Line Current:	0.66 Amps
Locked Rotor Current	1.75 Amps
Nominal Speed:	3700 RPM

## Mechanical Specifications

Dimensions:	4.7 x 4.7 x 1.3 in
Weight	8.47 oz
Max Airflow @ 0 in H <sub>2</sub> O	102.0 CFM
Max Pressure @ 0 CFM	0.350 in H <sub>2</sub> O
Noise	47.8 dBA



## Mechanical Drawing

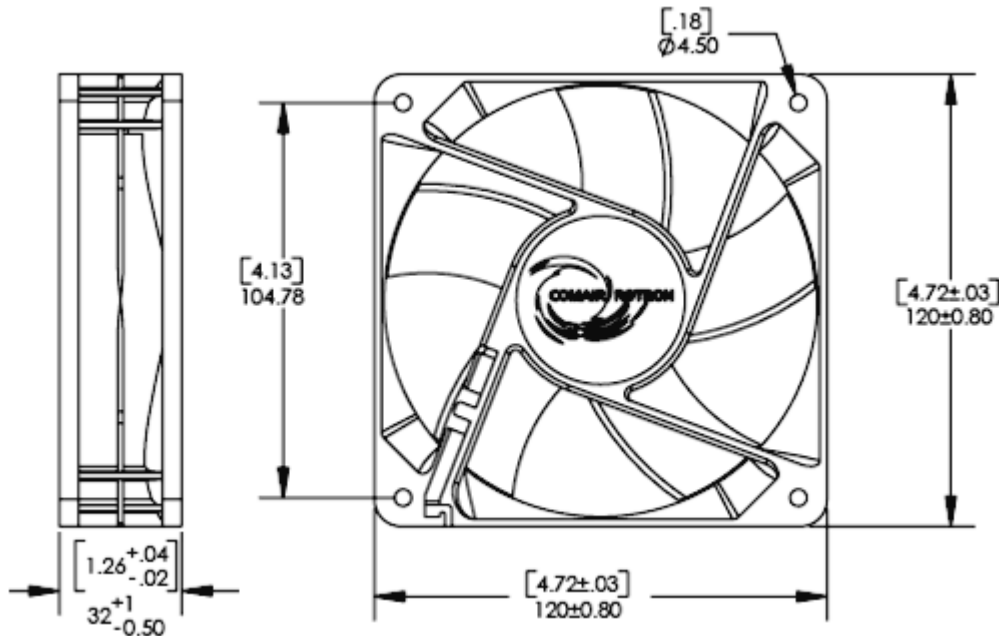

Comair Rotron, Inc.  
 Phone: 619.651.2000  
 sales@comairrotron.com

Comair Rotron Europe, Ltd.  
 Phone: +44.1527.520525  
 saleseurope@comairrotron.com

Comair Rotron Fan Company Ltd.  
 Phone: +86.21.52260581  
 salesasia@comairrotron.com

Print Date: Wednesday, May 12, 2010 at 09:56:46 - DC Fan Datasheet - Web Version 1.0 Rev. B



## Fan Performance Curve

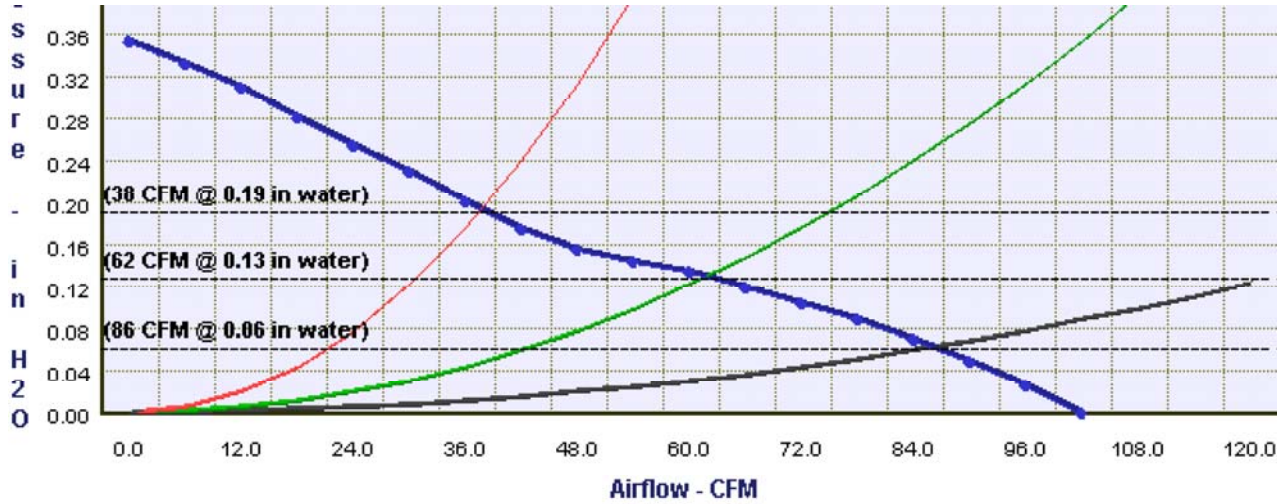

## Fan Configuration Options

**Muffin** (Family)   
 **MC12B3 / 032489** (Model) (Part #)   
 **No** (In Stock)   
 **305 mm [12 inch] Leads** (Features)

**Fan Speed:** 3700 RPM   
 **Fan Bearings:** Ball Bearings  
**Fan Airflow Direction:** Flow R (CCW Rotation)   
 **Fan Termination:** Leads

**Fan Monitoring Options:** No Fan Monitoring Options Selected

**Fan Speed Control Option:** No ThermaPro-V Fan Speed Control Options Selected

**Environmental Protection Options:** No Enviroshield Options Selected

Comair Rotron, Inc.  
 Phone: 619.651.2000  
 sales@comairrotron.com

Comair Rotron Europe, Ltd.  
 Phone: +44.1527.520525  
 saleseurope@comairrotron.com

Comair Rotron Fan Company Ltd.  
 Phone: +86.21.52260581  
 salesasia@comairrotron.com

Print Date: Wednesday, May 12, 2010 at 09:56:46 - DC Fan Datasheet - Web Version 1.0 Rev. B



**Accessories** (Click on part number for detailed drawing.)

- 477663  
Mounting Clip

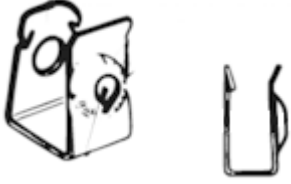

- 551590  
Filter Assembly

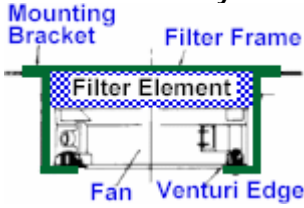

- 554148  
Filter Guard Assembly

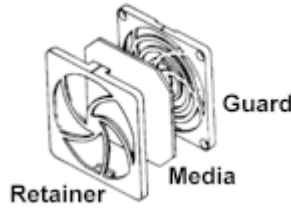

- 552934  
Finger Guard

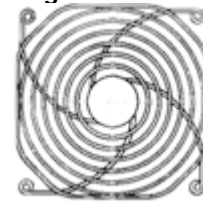

- 476042  
Finger Guard

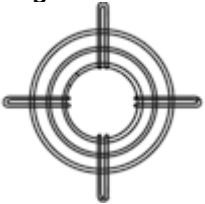

- 550481  
Finger Guard



- 551147  
Finger Guard



Comair Rotron, Inc.  
Phone: 619.651.2000  
sales@comairrotron.com

Comair Rotron Europe, Ltd.  
Phone: +44.1527.520525  
saleseurope@comairrotron.com

Comair Rotron Fan Company Ltd.  
Phone: +86.21.52260581  
salesasia@comairrotron.com

Print Date: Wednesday, May 12, 2010 at 09:56:46 - DC Fan Datasheet - Web Version 1.0 Rev. B