

Apr.1.2017 Copyright 2017 HIROSE ELECTRIC CO., LTD. All Rights Reserved.

1		2		3		4		5		6		7		8	
COUNT	DESCRIPTION OF REVISIONS	BY	CHKD	DATE	COUNT	DESCRIPTION OF REVISIONS	BY	CHKD	DATE	COUNT	DESCRIPTION OF REVISIONS	BY	CHKD	DATE	
△					△					△					
△					△					△					
△					△					△					

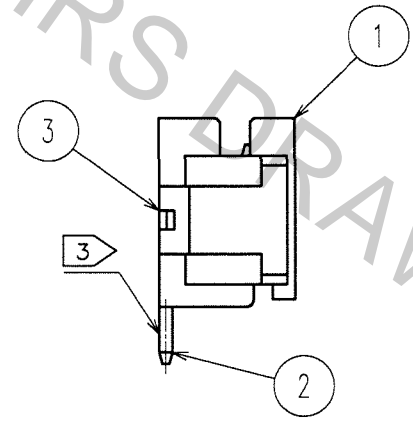

APPLICATION DRAWING

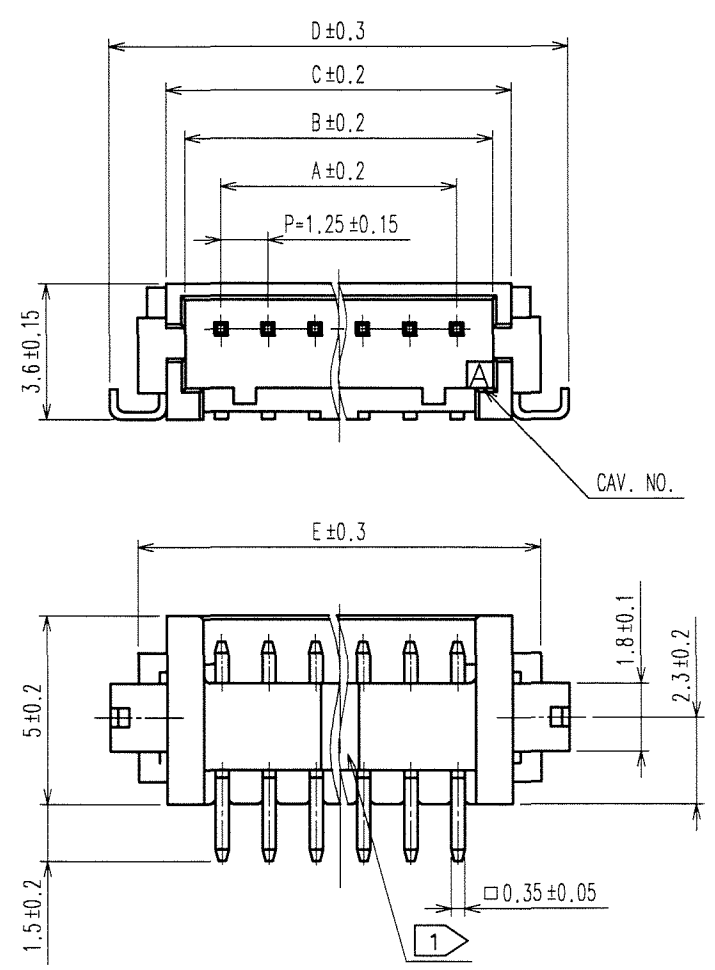
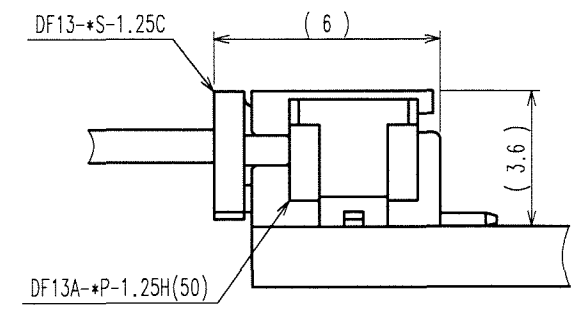

RECOMMENDED PATTERN

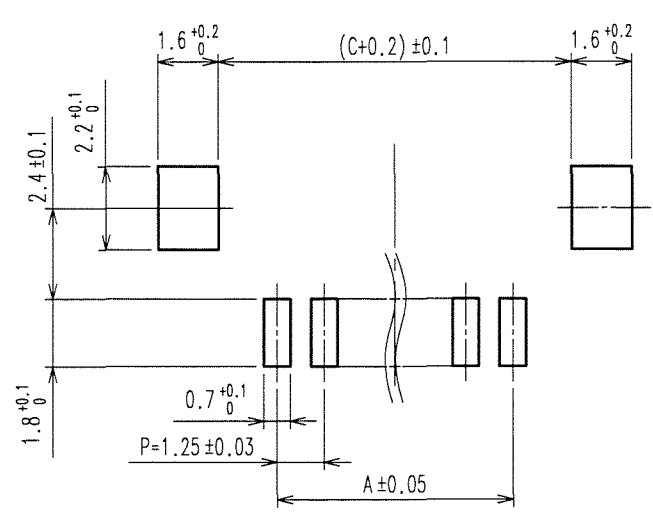
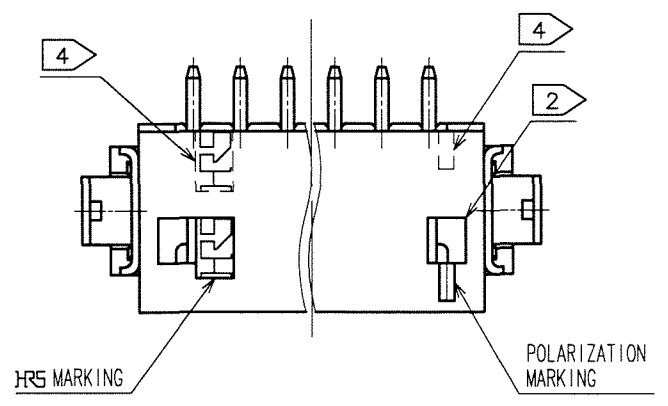

CODE No.	PARTS No.	NUMBER OF CONTACT	A	B	C	D	E
CL536-0301-8-50	DF13A- 2P-1.25H(50)	2	1.25	3.15	4.15	7.15	5.65
CL536-0302-0-50	DF13A- 3P-1.25H(50)	3	2.50	4.40	5.40	8.40	6.90
CL536-0303-3-50	DF13A- 4P-1.25H(50)	4	3.75	5.65	6.65	9.65	8.15
CL536-0304-6-50	DF13A- 5P-1.25H(50)	5	5.00	6.90	7.90	10.90	9.40
CL536-0305-9-50	DF13A- 6P-1.25H(50)	6	6.25	8.15	9.15	12.15	10.65
CL536-0306-1-50	DF13A- 7P-1.25H(50)	7	7.50	9.40	10.40	13.40	11.90
CL536-0307-4-50	DF13A- 8P-1.25H(50)	8	8.75	10.65	11.65	14.65	13.15
CL536-0308-7-50	DF13A- 9P-1.25H(50)	9	10.00	11.90	12.90	15.90	14.40
CL536-0309-0-50	DF13A-10P-1.25H(50)	10	11.25	13.15	14.15	17.15	15.65
CL536-0310-9-50	DF13A-11P-1.25H(50)	11	12.50	14.40	15.40	18.40	16.90
CL536-0311-1-50	DF13A-12P-1.25H(50)	12	13.75	15.65	16.65	19.65	18.15
CL536-0313-7-50	DF13A-14P-1.25H(50)	14	16.25	18.15	19.15	22.15	20.65
CL536-0314-0-50	DF13A-15P-1.25H(50)	15	17.50	19.40	20.40	23.40	21.90

- NOTES
- 1: THERE SHALL BE STANDOFF MORE THAN FIVE CONTACTS.
 - 2: WHEN THIS CONNECTOR HAS TWO OR THREE CONTACTS, THE LOCK SHALL BE SET AT THE CENTER OF HOUSING. IF MORE THAN FOUR, THE TWO LOCKS SHALL BE SET AS SHOWN ON THIS DRAWING.
 - 3: FLATNESS OF LEAD WITH REINFORCED METAL FITTINGS SHALL BE WITHIN 0.1mm.
 - 4: WHEN THIS CONNECTOR HAS MORE THAN SEVEN CONTACTS, HRS MARKING AND POLARIZATION MARKING SHIFT TO THE PLACE INDICATING DOTTED LINES.

2	BRASS	SURFACE: GOLD PLATED 0.2μm min UNDER PLATING: NICKEL PLATED 0.5μm min	5	S. PVC	STOPPER, GRAY
1	POLYAMIDE	UL94V-0, NATURAL (BEIGE)	4	R. PVC	ANTI-ELECTRIFICATION, CLEAR, STICK
No.	MATERIAL	FINISH, REMARKS	No.	MATERIAL	FINISH, REMARKS
CODE NO. (OLD)			DRAWN	DESIGNED	CHECKED
			A. Miura	T. Kumazawa	H. Umehara
			'06.05.22	'06.05.23	'06.05.23
			APPROVED	RELEASED	
			J. Oma		
			'06.05.24		
DRAWING NO.			PART NO.		
EDC3-162444-07			DF13A-*P-1.25H(50)		
SCALE			CODE NO.		
5 : 1			CL536-		
UNITS			1/2		
mm			HRS HIROSE ELECTRIC CO., LTD		

TO

Apr.1.2017 Copyright 2017 HIROSE ELECTRIC CO., LTD. All Rights Reserved.

COUNT	DESCRIPTION OF REVISIONS	BY	CHKD	DATE	COUNT	DESCRIPTION OF REVISIONS	BY	CHKD	DATE
△				..	△				..
△				..	△				..
△				..	△				..

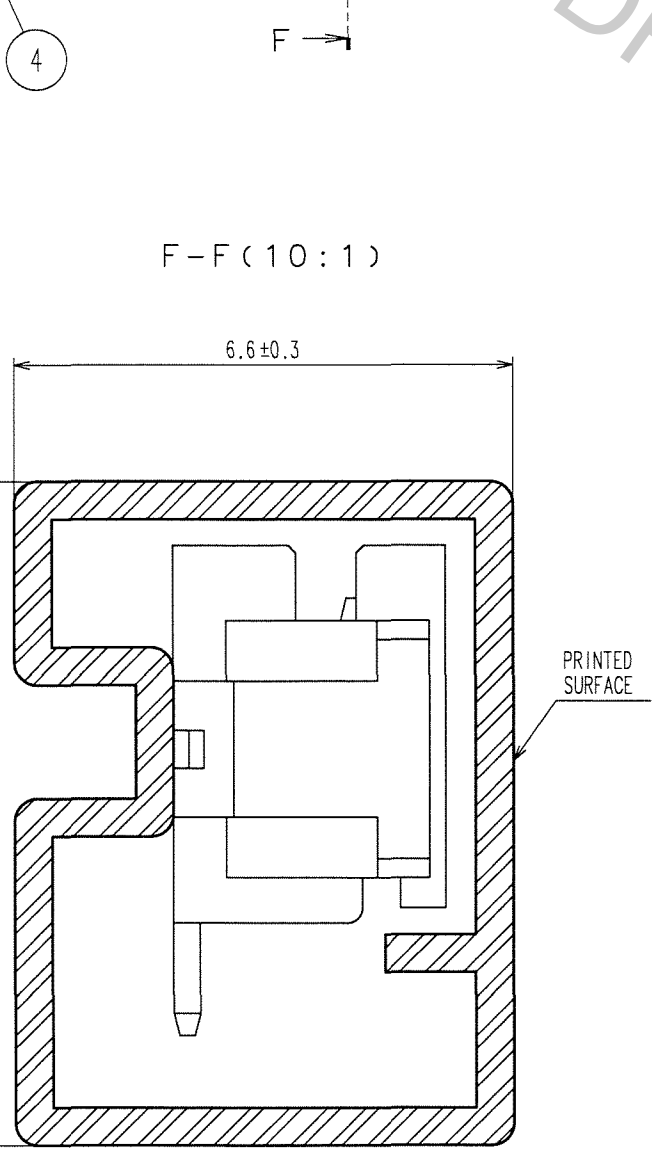
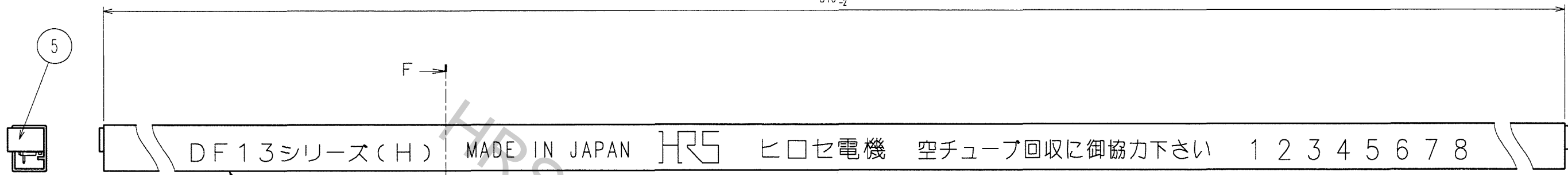

CODE No.	PARTS No.	PACKING AMOUNT
CL536-0301-8-50	DF13A- 2P-1.25H(50)	67
CL536-0302-0-50	DF13A- 3P-1.25H(50)	57
CL536-0303-3-50	DF13A- 4P-1.25H(50)	49
CL536-0304-6-50	DF13A- 5P-1.25H(50)	44
CL536-0305-6-50	DF13A- 6P-1.25H(50)	39
CL536-0306-1-50	DF13A- 7P-1.25H(50)	36
CL536-0307-4-50	DF13A- 8P-1.25H(50)	33
CL536-0308-7-50	DF13A- 9P-1.25H(50)	30
CL536-0309-0-50	DF13A-10P-1.25H(50)	28
CL536-0310-9-50	DF13A-11P-1.25H(50)	26
CL536-0311-1-50	DF13A-12P-1.25H(50)	24
CL536-0313-7-50	DF13A-14P-1.25H(50)	21
CL536-0314-0-50	DF13A-15P-1.25H(50)	20

CODE NO. (OLD) CL	DRAWN A.Miura '06.05.22	DESIGNED T.Kumogawa '06.05.23	CHECKED H.Umehara '06.05.23	APPROVED J.Oma '06.05.24	RELEASED
SCALE 5 : 1	DRAWING NO. EDC3-162444-07		PART NO. DF13A-*P-1.25H(50)		
UNITS mm	HRS HIROSE ELECTRIC CO., LTD		CODE NO. CL536-		2

TO