

# Relays and solid-state relays

## Catalogue 2015/2016

Let's connect.

Digital signal processing

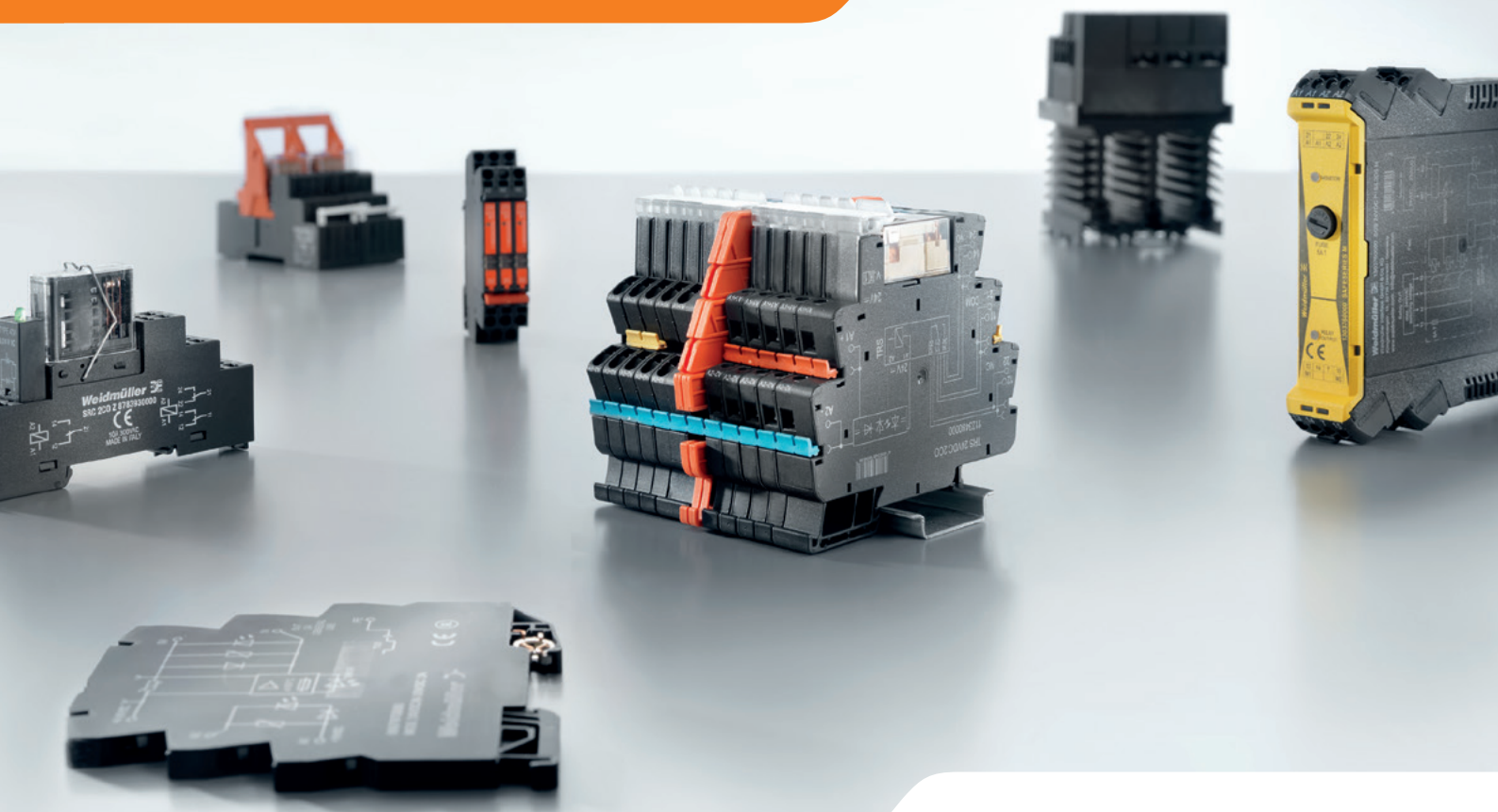





# Relays and solid-state relays

## Catalogue 4.2

### Relays and solid-state relays

Relay modules and solid-state relays in 6 mm width

Industrial relay modules

Power electronics

Safety relay

Timer

Inhalt

A

B

C

D

E

### Appendix

Technical appendix/Glossary

Index

Index Type / Index Order No.  
Addresses worldwide

W

X

# Relays and solid-state relays

## TERMSERIES relay modules

Page A.8

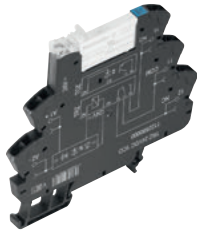

- All-purpose, pluggable relay modules
- Space-saving width
- AgNi contact with and without gold plating
- Screw and tension clamp connection

## TERMSERIES – solid-state relays

Page A.28

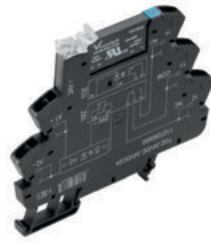

- All-purpose, pluggable solid-state relays
- Space-saving width
- DC and AC output variants
- Screw and tension clamp connection

## TERMSERIES adapters

Page A.52



- Suitable for input and output logic
- Version for TERMSERIES base

## TERMOPTO – solid-state relays

Page A.58



- Isolation of potentials in terminal format
- With PUSH IN technology
- Compact, enclosed design

## MICROOPTO – solid-state relays

Page A.70



- Compact semiconductor switch in terminal format
- High power for loads up to 10 A
- Electrically isolates high-speed signals
- International approvals

## MCZ SERIES relay modules

Page A.80

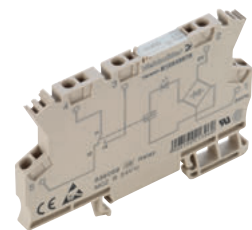

- Low profile with tension clamp connection
- TRAK version developed for the rail industry
- Large temperature range of -40 °C to +70 °C

## MCZ-SERIES – solid-state relays

Page A.86

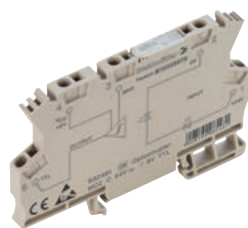

- Low profile with tension clamp connection
- Universal interface between controller and sensor/actuator
- TRAK version developed for the rail industry

## D-SERIES relay modules

Page B.6



- Modularly designed product line
- Pluggable variants with 1 to 4 CO contacts
- Special variants for switching high DC loads

## RIDERSERIES relay modules

Page B.48



- Modularly designed product line
- Pluggable variants with 1 to 4 CO contacts
- Innovative relay base with PUSH IN connection

**RIDERSERIES FG relay modules**

Page B.78



- Modularly designed product line
- Relays with positively driven contacts
- Screw or tension clamp connection

**PSSR 1-phase Power solid-state relays**

Page C.4



- Load circuit: 12...275 V AC / 25 A or 24...600 V AC/35 A
- Zero-cross switch
- Ready to use
- Attachable monitoring module

**PSSR 1-phase Power solid-state relays**

Page C. 8



- Load circuit: 24...600 V/50 A or 75 A
- No-voltage switch
- Compact design

**PSSR 1-phase phase angle control**

Page C. 10



- Load circuit: 200...460 V AC/70 A
- 4-20 mA control input
- Manual phase angle calibration

**PSSR 3-phase Power solid-state relays**

Page C.12



- Load circuit: 24...520 V AC / 20 A at 55 °C
- No-voltage switch
- Ready to use

**SIL relay**

Page D.6



- TÜV "Safety-Approved"
- SIL3 acc. to EN61508
- De-energise/Energise to Safe applications

**BT-SERIES - Timer**

Page E.4



- Time range: 0.10 s...120 h
- Screw or tension clamp connection
- International approvals

**Timer with 6 mm width**

Page E.8

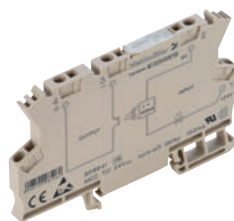

- Components for lengthening short pulses for the PLC
- Low input power
- DKZ Series with adjustable switch-off delay

# Selection table for TERMSERIES

## Relay modules from 6 mm width

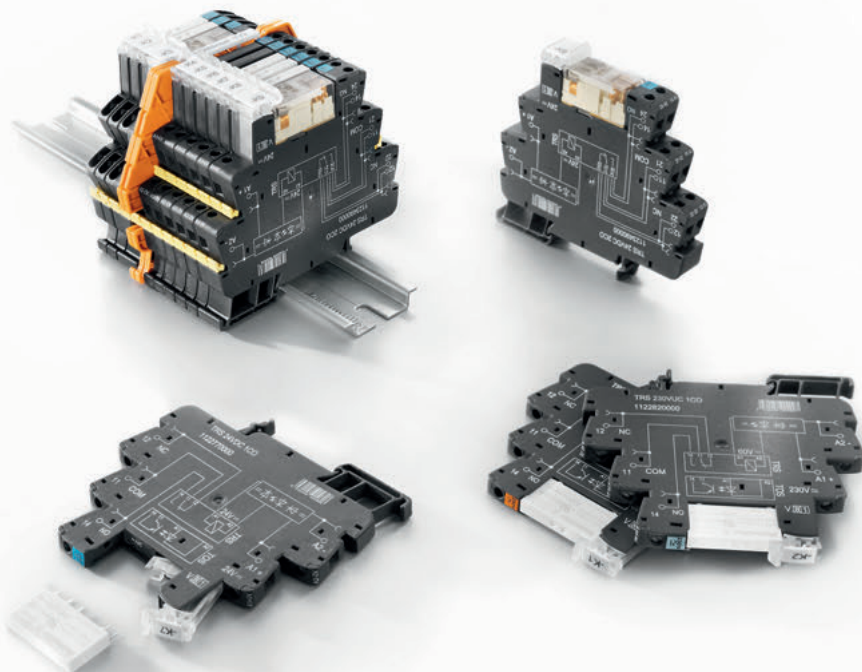

Number of contacts / Type of contact		1 NO		1 CO			2 CO	
		AgSnO 16 A	AgSnO + W 16 A	AgNi 6 A	AgNi + 5µAu	AgNi 16 A	AgNi 8 A	AgNi + 5µAu
Voltage / Input DC	Connection							
5 V DC	Screw			1122740000	1122980000	1479650000	1123470000	1123710000
	Tension clamp			1122860000	1123100000	1479800000	1123590000	1123830000
12 V DC	Screw			1122750000	1122990000	1479670000	1123480000	1123720000
	Tension clamp			1122870000	1123110000	1479820000	1123600000	1123840000
24 V DC	Screw	1479780000	1479810000	1122770000	1123000000	1479680000	1123490000	1123730000
	Tension clamp	1479940000	1479970000	1122880000	1123120000	1479840000	1123610000	1123850000
<b>Input UC</b>								
24 V UC	Screw			1122780000	1123010000	1479690000	1123500000	1123740000
	Tension clamp			1122890000	1123130000	1479850000	1123620000	1123870000
48 V UC	Screw			1122790000	1123020000	1479700000	1123510000	1123750000
	Tension clamp			1122900000	1123140000	1479870000	1123630000	1123880000
60 V UC	Screw			1122800000	1123030000	1479710000	1123520000	1123770000
	Tension clamp			1122910000	1123150000	1479880000	1123640000	1123890000
120 V UC	Screw			1122810000	1123170000	1479730000	1123530000	1123780000
	Tension clamp			1122920000	1123040000	1479890000	1123650000	1123900000
230 V UC	Screw			1122820000	1123050000	1479740000	1123540000	1123790000
	Tension clamp			1122930000	1123180000	1479900000	1123670000	1123910000
24 - 230 V UC	Screw	1479790000	1479830000	1122850000	1123090000	1479770000	1123580000	1123820000
	Tension clamp	1479950000	1479980000	1122970000	1123210000	1479930000	1123700000	1123940000
<b>Input AC</b>								
120 V AC RC	Screw			1122830000	1123070000	1479750000	1123550000	1123800000
	Tension clamp			1122940000	1123190000	1479910000	1123680000	1123920000
230 V AC RC	Screw			1122840000	1123080000	1479760000	1123570000	1123810000
	Tension clamp			1122950000	1123200000	1479920000	1123690000	1123930000
<b>Note</b>	Selection of preferred types, other modules upon request							

# Selection table for D-SERIES

## Industrial relay modules



Series	DRM			DRL		
	2 CO AgNi 10 A	4 CO AgNi 5 A	1 CO AgCdO 16 A	2 CO AgCdO 10 A	3 CO AgCdO 10 A	4 CO AgCdO 10 A
<b>Number of contacts / Type of contact</b>						
<b>Contact material / Current</b>						
<b>Voltage / Input DC</b>						
12 V DC	7760056068	7760056096	1133450000	1133510000	1133570000	1133620000
24 V DC	7760056069	7760056097	1133460000	1133520000	1133580000	1133630000
48 V DC	7760056070	7760056098	1133470000	1133530000	1133590000	1133640000
110 V DC	7760056071	7760056099	1133480000	1133540000	1133600000	1133650000
220 V DC	7760056072	7760056100	1133400000	1133550000	1133610000	1133660000
<b>Input AC</b>						
24 V AC	7760056073	7760056101	1133840000	1133870000	1133910000	1133940000
48 V AC	7760056074	7760056102				
120 V AC	7760056075	7760056103	1133850000	1133880000	1133920000	1133950000
230 V AC	7760056076	7760056104	1133860000	1133890000	1133930000	1133960000
<b>Preferred suitable socket</b>						
Screw, clamping yoke	7760056106	7760056107	7760056225	7760056225	7760056226	7760056227
Screw, tension clamp	7760056263	7760056264				
<b>Note</b>	Preferred types of D-SERIES incl. status indication and test key More coils and contact-types upon request					

Series	DRW		DRH		DRR	
	2 CO AgCdO 16 A	3 CO AgCdO 16 A	1 NO AgCdO 16 A	2 NO AgCdO 16 A	2 CO AgNi 10 A	3 CO AgNi 10 A
<b>Number of contacts / Type of contact</b>						
<b>Contact material / Current</b>						
<b>Voltage / Input DC</b>						
12 V DC	1219730000	1219780000	1220140000	1219840000	1133360000	1133410000
24 V DC	1219740000	1219790000	1220150000	1219850000	1133370000	1133420000
48 V DC	1219750000	1219810000	1220170000	1219860000	1133380000	1133430000
110 V DC	1219760000	1219820000	1220180000	1219870000	1133390000	1133440000
220 V DC	1219770000	1219830000	1220190000	1219880000	1133400000	1133450000
<b>Input AC</b>						
24 V AC	1219350000	1219410000	1220200000	1219890000	1133760000	1133810000
48 V AC	1219360000	1219420000	1220210000	1219910000		
120 V AC	1219370000	1219430000	1220220000	1219920000	1133780000	1133820000
230 V AC	1219380000	1219440000	1220230000	1219930000	1133800000	1133830000
400 V AC	1219390000	1219450000				
<b>Preferred suitable socket</b>						
Screw, clamping yoke	1220250000	1220250000	1220250000	1220250000	1132810000	1132820000
<b>Note</b>	Preferred types of D-SERIES incl. status indication and test key More coils and contact-types upon request					

# Selection table for RIDERSERIES

## Industrial relay modules

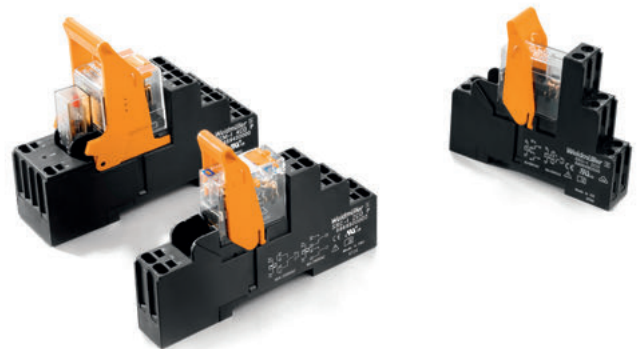

Series	RCI		RCM			RRD	
	1 CO AgNi 16 A	2 CO AgNi 8 A	2 CO AgNi 12 A	3 CO AgNi 10 A	4 CO AgNi 6 A	2 CO AgNi 10 A without recovery diode	3 CO AgNi 10 A without LED
<b>Voltage / Input DC</b>							
12 V DC	8870240000	8870310000	8957020000	8957090000	8957160000		
24 V DC	8870250000	8870320000	8957030000	8957100000	8957170000	8690380000	8797650000
48 V DC	8870260000	8870330000	8957040000	8957110000	8957180000	8690400000	
110 V DC	8870270000	8870340000	8957050000	8957120000	8957190000		8797640000
220 V DC					8636230000		8797610000
<b>Input AC</b>							
24 V AC	8870280000	8870350000	8689770000	8689950000	8690120000	8690280000	8690460000
48 V AC				8689970000	8690130000		8690480000
120 V AC	8870290000	8870360000	8689810000	8689990000	8690150000	8690320000	8690560000
230 V AC	8870300000	8870370000	8689830000	8690010000	8690160000	8690340000	8690580000
<b>Preferred suitable socket</b>							
Screw	8869490000	8869490000	8869400000	8869410000	8869420000	8869360000	8869350000
Tension clamp or Push In	8869500000	8869500000	8876220000		8869430000		
<b>Note</b> Preferred types of RIDERSERIES incl. recovery diode (DC-coil), status indication and test key More coils and contact-types upon request							

Series	Number of contacts / Type of contact Contact material	RCI KIT		RCM KIT		
		1 CO AgNi	2 CO AgNi	2 CO AgNi	3 CO AgNi	4 CO AgNi
<b>Voltage / Input DC</b>		<b>Connection</b>				
24 VDC	Screw	8881580000	8881610000	8920940000	8920980000	8921030000
	PUSH IN	8897190000	8897230000	8921080000		8921120000
<b>Input AC</b>						
24 V AC	Screw	8881590000	8881620000	8920950000	8920990000	8921040000
	PUSH IN	8897200000	8897240000	8921090000		8921130000
115 V / 120 V AC	Screw	8897060000	8897080000	8920960000	8921010000	8921060000
	PUSH IN	8897210000	8897250000	8921100000		8921140000
230 V AC	Screw	8881600000	8881630000	8920970000	8921020000	8921060000
	PUSH IN	8897220000	8897260000	8921110000		8921150000
<b>Note</b> Preferred types of RIDERSERIES incl. recovery diode (DC-coil), status indication and test key More coils and contact-types upon request						

# Selection table for TERMOPTO and TERMSERIES

## Solid-state relays from 6 mm width

### Load side

Voltage type		DC	DC	DC	DC	AC	AC
Switching voltage		5...48 V	5...48 V	24 V	24 V	24...240 V	24...240 V
Switching current		< 100 mA	<= 500 mA	<= 2 A	<= 5 A	<= 100 mA	<= 1 A
Control side / Voltage AC	Series	Connection					
24 V AC	TERMOPTO	Screw	8950820000	8951020000			8951220000
		PUSH IN	8950860000	8951060000			8951260000
48...60 V AC	TERMOPTO	Screw	8950830000	8951030000			8951230000
		PUSH IN	8950870000	8951070000			8951270000
120 V AC	TERMOPTO	Screw	8950840000	8951040000			8951240000
		PUSH IN	8950880000	8951080000			8951280000
120 V AC RC	TERMSERIES	Screw	1127000000		1127230000		1127480000
		Tension clamp	1127110000		1127350000		1127600000
	TERMOPTO	Screw	1180290000				
		PUSH IN	1188830000				
230 V AC	TERMOPTO	Screw	8950850000	8951050000			8951250000
		PUSH IN	8950890000	8951090000			8951290000
230 V AC RC	TERMSERIES	Screw	1127010000		1127240000		1127490000
		Tension clamp	1127120000		1127370000		1127610000
	TERMOPTO	Screw	1189270000				
		PUSH IN	1189260000				
<b>DC</b>							
5 V DC	TERMSERIES	Screw	1126920000		1127140000		1127390000
		Tension clamp	1127030000		1127270000		1127510000
	TERMOPTO	Screw	8950700000	8950900000			8951100000
		PUSH IN	8950760000	8950960000			8951160000
12 V DC	TERMSERIES	Screw	1126930000		1127150000		1127400000
		Tension clamp	1127040000		1127280000		1127520000
	TERMOPTO	Screw	8950710000	8950910000			8951110000
		PUSH IN	8950770000	8950970000			8951170000
24 V DC	TERMSERIES	Screw	1126940000		1127170000	1127630000	1127410000
		Screw			1391680000	1127680000	
		Tension clamp	1127050000		1127290000	1127650000	1127530000
		Tension clamp			1391690000	1127700000	
	TERMOPTO	Screw	8950720000	8950920000			8951120000
		PUSH IN	8950780000	8950980000		1254880000	8951180000
48...60 V DC	TERMOPTO	Screw	8950730000	8950930000			8951130000
		PUSH IN	8950790000	8950990000			8951190000
110 V DC	TERMOPTO	Screw	8950740000	8950940000			8951140000
		PUSH IN	8950800000	8951000000			8951200000
220 V DC	TERMOPTO	Screw	8950750000	8950950000			8951150000
		PUSH IN	8950810000	8951010000			8951210000
<b>UC</b>							
24 V UC	TERMSERIES	Screw	1126950000		1127180000		1127420000
		Tension clamp	1127060000		1127300000		1127540000
24...230 V UC	TERMSERIES	Screw	1127020000		1127250000	1127640000	1127500000
		Screw				1127690000	
		Tension clamp	1127130000		1127380000	1127670000	1127620000
		Tension clamp				1127710000	
48 V UC	TERMSERIES	Screw	1126960000		1127190000		1127430000
		Tension clamp	1127070000		1127310000		1127550000
60 V UC	TERMSERIES	Screw	1126970000		1127200000		1127440000
		Tension clamp	1127080000		1127320000		1127570000
115 V / 120 V UC	TERMSERIES	Screw	1126980000		1127210000		1127450000
		Tension clamp	1127090000		1127330000		1127580000
230 V UC	TERMSERIES	Screw	1126990000		1127220000		1127470000
		Tension clamp	1127100000		1127340000		1127590000

**Note** Selection of preferred types, other modules upon request.



# Selection table for MICROOPTO

## Solid-state relays in 6 mm width for specific applications

### Load side

Voltage type	DC	DC	DC	DC
Switching voltage	5...48 V DC	8...30 V DC	5...33 V DC	12...300 V DC
Switching current	0,5 A	2 A	10 A	1 A
Control side / Voltage	24 V DC			
Remarks	8937980000 Electronic CO contact 1 kHz switching frequency	8937970000 Actuator switch 3-wire connection Short-circuit-proof Thermal overload fuse	8937940000 Valve switch Short-circuit-proof Alarm contact	8937830000 Switch for inductive loads Power Boost



# Selection table for Power solid-state relays

Load side	1-phase				3-phase
Voltage type	AC	AC	AC	AC	AC
Switching voltage	12...275 V AC	24...600 V AC	24...600 V AC	24...600 V AC	24...520 V AC
Switching current	25 A	35 A	50 A	75 A	20 A
Heatsink	yes	yes	no	no	yes
Control side / Voltage	3...32 V DC				
	1406200000	1406210000	1406240000	1406250000	
	160...240 V AC/DC	1406220000			
Monitoring module (plug-in)	1406230000	1406230000			
8...30 V DC / 10...30 V AC					8952130000
9...240 V AC/DC					8952140000



Find all the information about our extensive range of relay modules and solid-state relays on our website or in our online catalog.

[www.weidmuller.com/relay](http://www.weidmuller.com/relay)



Let's connect.



# Relay modules and solid-state relays in 6 mm width

<b>Relay modules and solid-state relays in 6 mm width</b>	Relay modules and solid-state relays in 6 mm width - Overview	A.2
	TERMSERIES - Overview	A.4
	TERMSERIES - relay modules	A.8
	TERMSERIES - solid-state relays	A.28
	TERMSERIES adapters	A.52
	TERMOPTO - Overview	A.56
	TERMOPTO - solid-state relays	A.58
	MICROOPTO - Overview	A.68
	MICROOPTO - solid-state relays	A.70
	MCZ-SERIES - relay modules	A.80
	MCZ-SERIES - solid-state relays	A.86

## Coupling modules in a terminal block design

### Relay modules and solid-state relays in 6 mm width

Weidmüller's relay couplers and solid-state relays feature excellent electrical characteristics. They also take advantage of the same reliable connection technology that has proven itself countless times in terminal products. This product line is ideally complimented by a wide variety of system accessories such as labelling material and end brackets. This helps to reduce your inventory overhead and stock levels. During the design of compact components, it is especially challenging to maintain minimal power loss since the small housing can exchange very little power with its surroundings. This challenge has already been mastered by Weidmüller since 1989. It was the first product in the terminal block format to come to market and it has been continually improved since then. Two compact but powerful semiconductor switches TERMOPTO and MICROOPTO also meet this challenge. The new TERMSERIES combines the proven properties of the established product lines with innovative technical solutions. A variable-voltage input has been specifically developed for the 6 mm disc design. This is the first time that the control of relay modules and solid-state relays can be used with voltages from 24 to 230 V DC/DC in this width. Another highlight is the ejector with integrated fibre-optic technology, which apart from allowing the simple and safe removal of the relay module and the solid-state relay, also illuminates the status indicator.

See for yourself, the quality of the Weidmüller's 6 mm products.



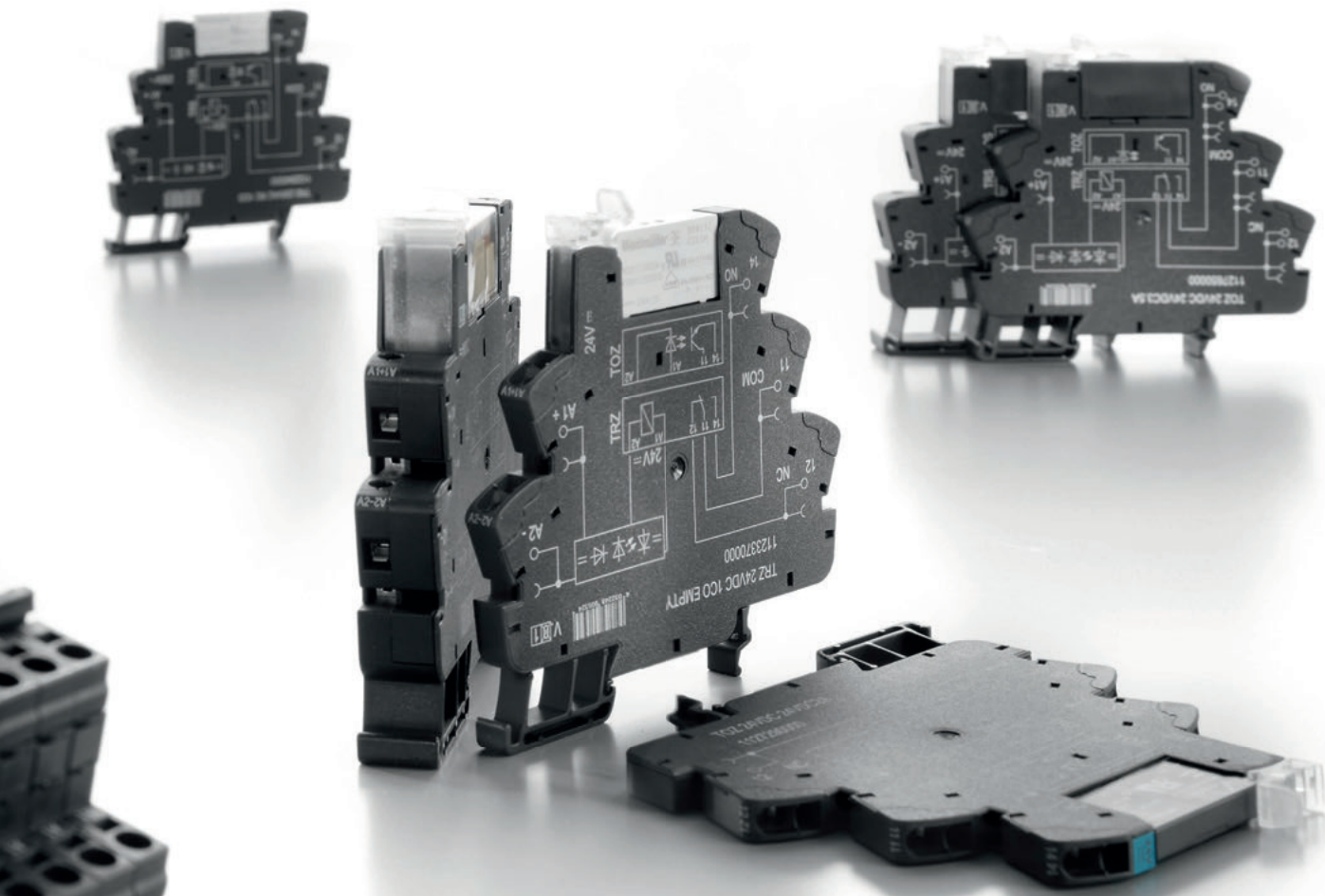

# Seamless integration is your wish

## Enjoy the solutions in our TERMSERIES, MICROOPTO and SAI series

Let's connect.

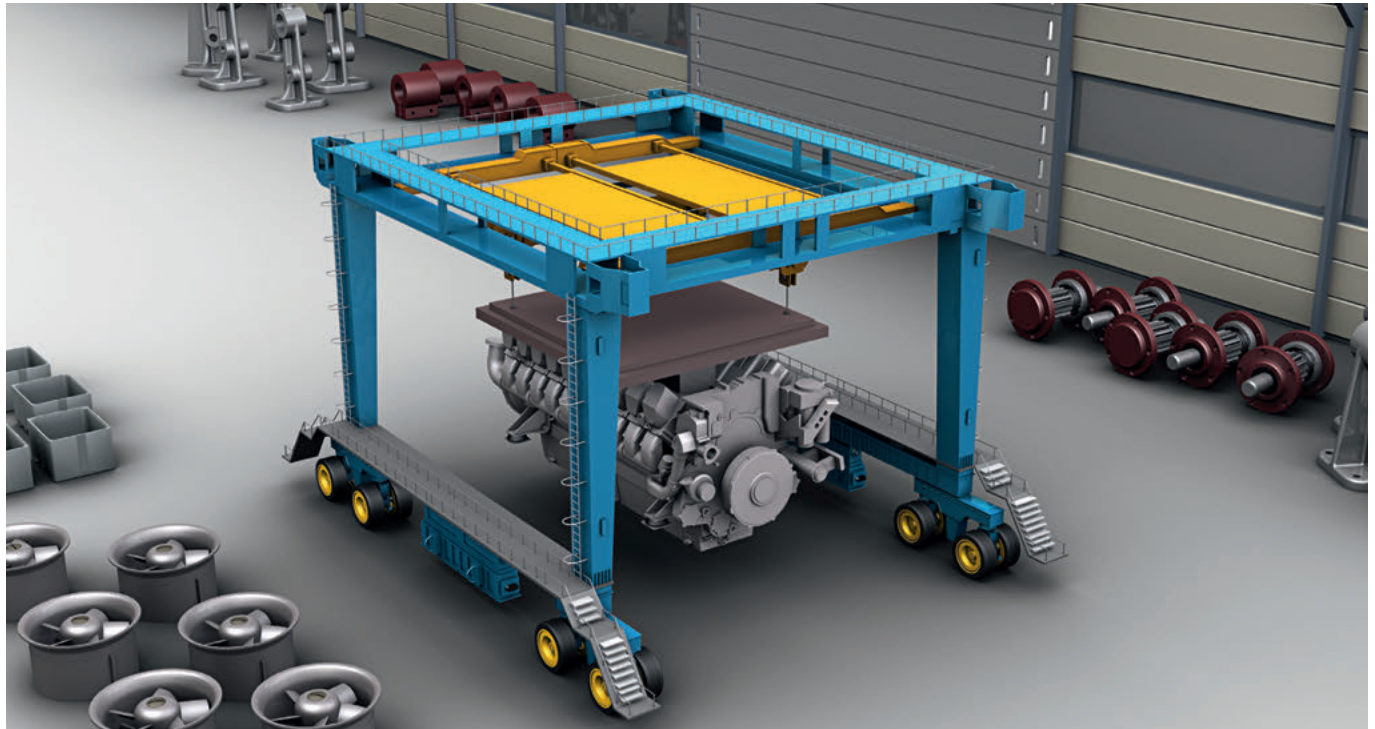

**Materials and time savings in system and process automation are influenced by two critical factors. On the one hand, it is important to be able to work on complex systems with numerous sensor connections and a broad range of voltage inputs. On the other hand, the reliability of the actuator connections in terms of lifetime and speed play a major role.**

The components in our TERMSERIES, MICROOPTO and SAI distributor series offer you this, in perfect combination. Our unique TERMSERIES multi-voltage input represents a universal relay coupler for all voltage inputs between 24 V and 230 V UC. These products also boast a slim terminal format and an eye-catching LED status display.

The MICROOPTO short circuit-proof semiconductor switch has the benefit of a practically unlimited lifetime, compared to traditional relay technology. Any alarms, e.g. such as those set off by a short circuit on the output side, are directly analysed by the SPS, which reports the service needed – for instance, examining the supply line or a solenoid valve – to the relevant post.

Our solution is rounded off with the SAI distributor in IP68, which ensures safe, protected and flexible signal connections in the field, such as those for the crane forward/reverse switch and for wear-and-tear monitors, overheating switches and impact sensors in materials handling technology.



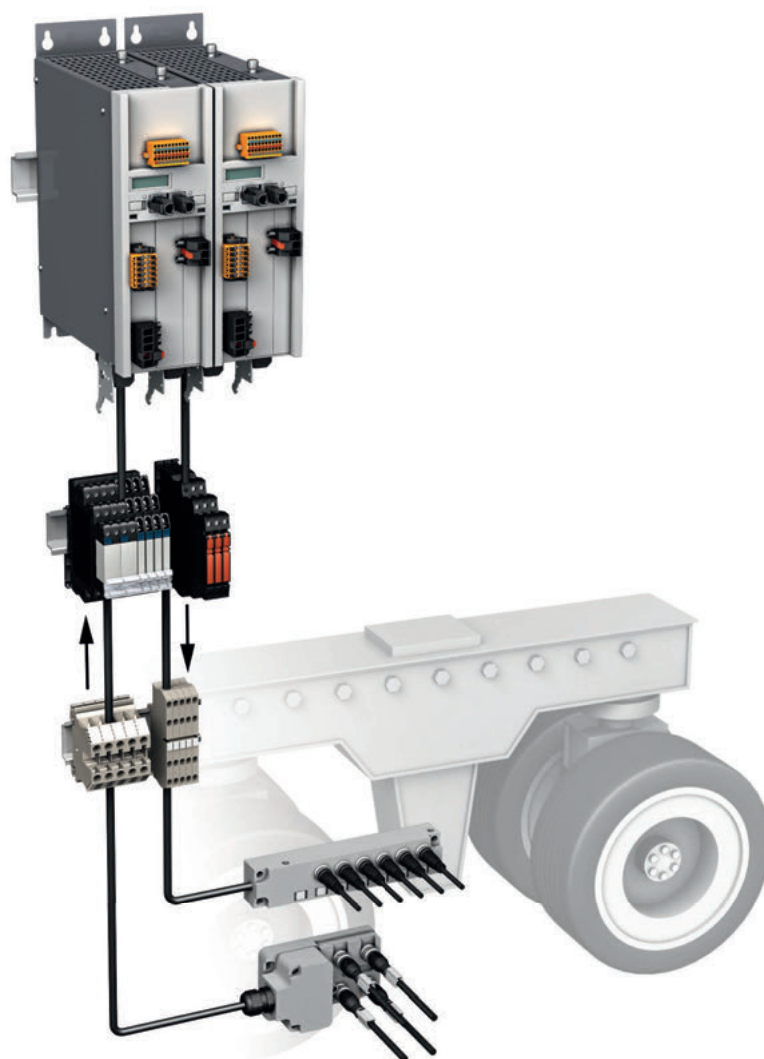

### TERMSERIES

- 6 and 12 mm relay couplers and semiconductor switches
- Multi-voltage input for 24 V to 230 V DC and AC
- Ideal visibility thanks to the illuminated ejector
- Partition plates and cross-connections for universal use



### MICROOPTO Solenoid

- Semiconductor relays of 6 mm width earthed to mounting rail
- Short-circuit-proof output
- Short circuit alarm via signal contact
- MTBF means a long lifetime of more than 1,100 years



### SAI distributors and lines

- M12 distributors which can be freely assembled in various formats
- Torsion-resistant wires available
- Very slim M8 distributor in line format
- All-metal distributor available

## Reliably switch industrial loads on a permanent basis

### TERMSERIES extension with increased power and longer service life

Generally speaking, industrial loads consist of either a capacitive element or an inductive element, which causes sparks during switch-on and switch-off operations. This shortens the service life of the relay contacts, thereby increasing the costs involved in running a plant.

The new relay modules from our TERMSERIES family feature special contacts that have been optimised (as regards arrangement and material selection) to the severe stresses of industrial use.

Whether they're deployed in machinery and plant engineering, robot technology, wind power, offshore technology or marine engineering – the compact variants from the TERMSERIES family of products allow you to reliably switch industrial loads for a long time and permanently minimise your application's operating costs.



LED lamps feature an electronic ballast, with a switching regulator that guarantees a start-up peak more than 100 times higher thanks to its capacitive design. When plants are converted from conventional filament lamps to LED lighting, this quickly causes conventional relay contacts to overload. The compact and powerful TERMSERIES relays can be upgraded quickly and without any complications.

## Your special advantages:

### Permanently reliable

An pre-making tungsten contact prevents contacts from welding during switch-on when capacitive loads are being switched. This extends their service life.

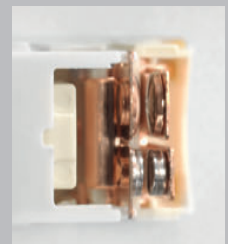

**Customised system approach**

With suitable supply terminals, partition plates, cross-connections, other relay modules and solid-state relay variants, we offer you a flexible modular system to isolate and amplify signals.

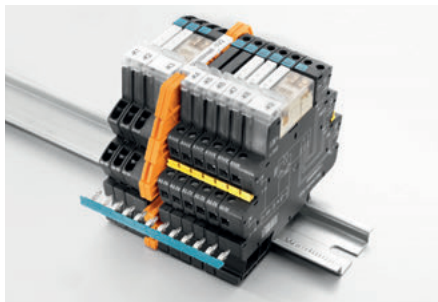

**All-purpose in use**

TERMSERIES is also available with the unique 24–230 V AC/DC multi-voltage input, which can be used with all relay and solid-state relay variants.



**Extremely compact**

Thanks to their compact width of just 12.8 mm, the modules fit just about anywhere on the DIN rail. This creates space in the cabinet.

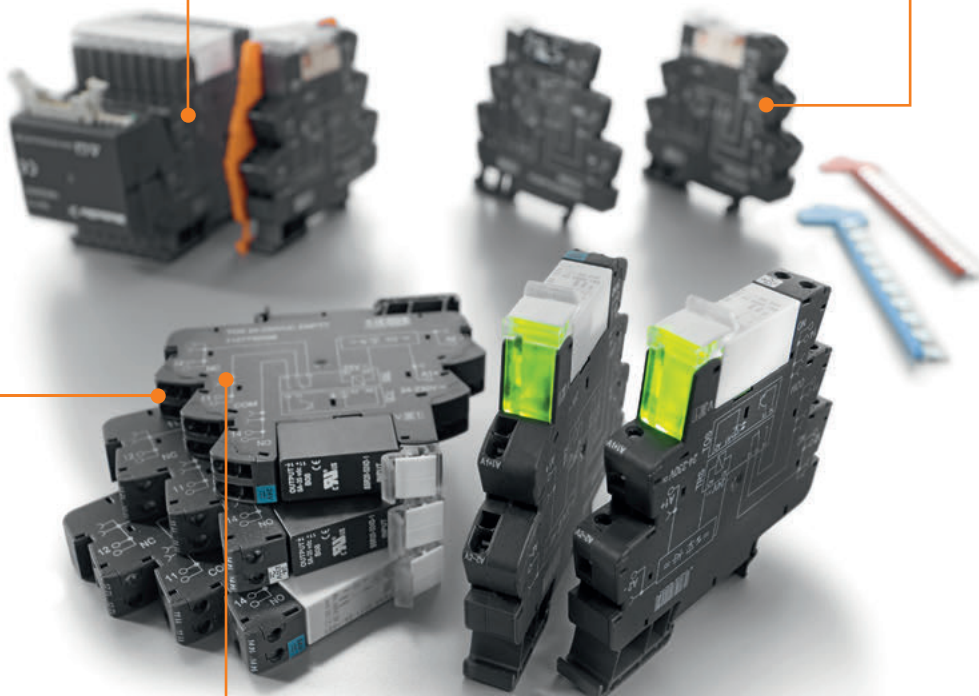

**Interface adapter for TERMSERIES relays**

Our pre-assembled plug-and-play solution with TERMSERIES interface adapter enables minimised cabling effort. The adapter has a universal fit and offers a genuine space advantage in interaction with the TERMSERIES products with identical contours.

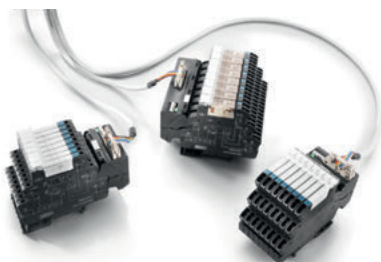

**Minimal intervention**

The new TERMSERIES variants can instantly switch the full 16 A load current thanks to the integrated cross-connection system.

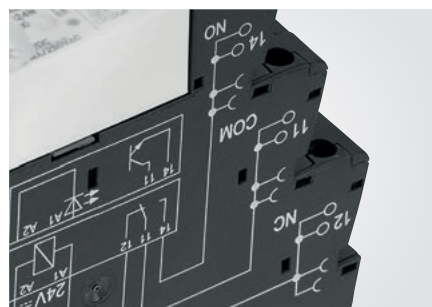

**1 CO contact**  
**AC/DC/UC coil**

- Space saving, just 6.4 mm modular width
- AgNi contact
- Screw and tension clamp connection

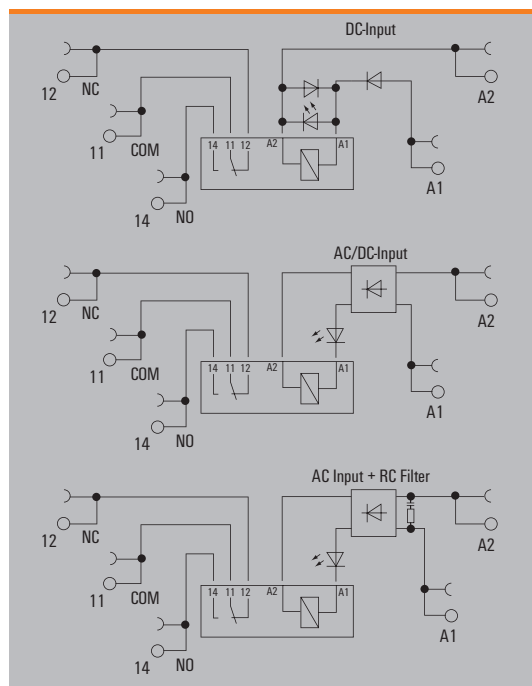
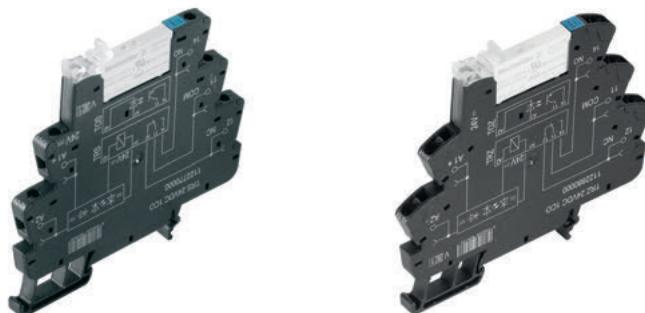

**Technical data**

<b>Output</b>			
Rated switching voltage / Continuous current	250 V AC / 6 A		
Max. switching voltage, AC	250 V		
Inrush current	20 A / 20 ms		
Min. switching power	100 mA / 5 V, 12 V / 10 mA, 24 V / 1 mA		
DC / AC Switching capacity (resistive), max.	144 W @ 24 V / 1500 VA		
Contact material	AgNi		
Mechanical service life	5 x 10 <sup>6</sup> switching cycles		
Max. switching frequency at rated load	0.1 Hz		
<b>Rated data</b>			
Ambient temperature (operational)	-40 °C...60 °C		
Storage temperature	-40 °C...85 °C		
Humidity	5-95% rel. humidity, T <sub>v</sub> = 40°C, no condensation		
Approvals	CE, cULus, EAC, GL		
<b>Insulation coordination (EN 50178)</b>			
Rated voltage	300 V		
Impulse withstand voltage	6 kV (1.2/50 µs)		
Dielectric strength input - output	4 kV <sub>eff</sub> / 1 min.		
Dielectric strength, contact / contact	4 kV <sub>eff</sub> / 1 min.		
Dielectric strength to mounting rail	4 kV <sub>eff</sub> / 1 min.		
Creepage and clearance distance input - output	≥ 5.5 mm		
Overtoltage category	III		
Pollution degree	2		
<b>Dimensions</b>			
Clamping range (nominal / min. / max.)	mm <sup>2</sup>	<b>Screw connection</b>	<b>Tension clamp connection</b>
		1.5 / 0.14 / 2.5	1.5 / 0.14 / 2.5
Depth x width x height		88 / 6.4 / 90	88 / 6.4 / 90
<b>Note</b>			
Accessories and dimensional drawings: refer to the TERMSERIES Accessories page.			

**Applications**

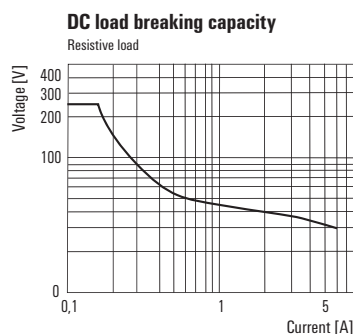
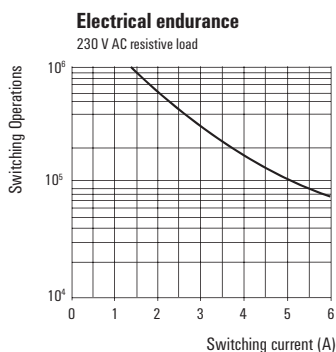



1 CO contact  
AC/DC/UC coil

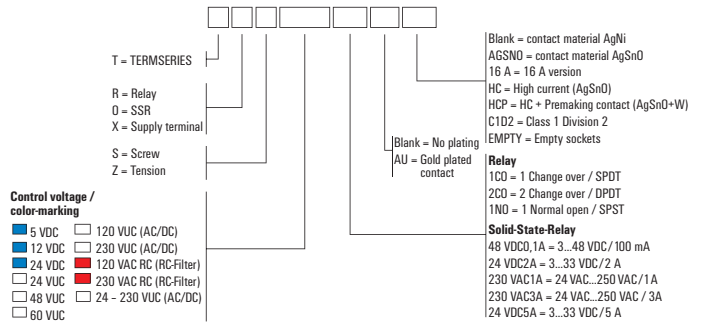

Ordering data

	5 V DC	12 V DC	24 V DC	24 V UC	48 V UC
<b>Input</b>					
Rated control voltage	5 V DC ±20 %	12 V DC ±20 %	24 V DC ±20 %	24 V UC ±10 %	48 V UC ±10 %
Rated current AC / DC	/ 35.8 mA	/ 18 mA	/ 10 mA	11.7 mA / 6.4 mA	8 mA / 7 mA
Power rating	200 mW	210 mW	240 mW	270 mVA / 154 mW	240 mVA / 192 mW
Pull-in/drop-out voltage, typ.	3.3 V / 1 V DC	8 V / 2 V DC	16 V / 4 V DC	16.5 V / 5.5 V AC 16.5 V / 5.5 V DC	29 V / 10 V AC 29 V / 10 V DC
Pull-in/drop-out current, typ.	21.6 mA / 8 mA DC	9 mA / 3 mA DC	7 mA / 2 mA DC	4 mA / 1.2 mA AC 4 mA / 1.2 mA DC	4 mA / 1.2 mA AC 4 mA / 1.2 mA DC
Status indicator	Green LED	Green LED	Green LED	Green LED	Green LED
Protective circuit	Integrated free-wheel diode, Reverse polarity protection	Integrated free-wheel diode, Reverse polarity protection	Integrated free-wheel diode, Reverse polarity protection	Rectifier	Rectifier
<b>Output</b>					
Switch-on delay	< 8 ms	< 7 ms	< 6 ms	< 4 ms	< 8 ms
Switch-off delay	< 4 ms	< 8 ms	< 7 ms	< 1.2 ms	< 4 ms

Ordering data

Screw connection	Type	TRS 5VDC 1CO	TRS 12VDC 1CO	TRS 24VDC 1CO	TRS 24VUC 1CO	TRS 48VUC 1CO
	Order No.	<b>1122740000</b>	<b>1122750000</b>	<b>1122770000</b>	<b>1122780000</b>	<b>1122790000</b>
Tension clamp conn.	Type	TRZ 5VDC 1CO	TRZ 12VDC 1CO	TRZ 24VDC 1CO	TRZ 24VUC 1CO	TRZ 48VUC 1CO
	Order No.	<b>1122860000</b>	<b>1122870000</b>	<b>1122880000</b>	<b>1122890000</b>	<b>1122900000</b>
<b>Note</b>		Spare relay Type: RSS113005 Orderno.: 4061580000	Spare relay Type: RSS113012 Orderno.: 4061610000	Spare relay Type: RSS113024 Orderno.: 4060120000	Spare relay Type: RSS113024 Orderno.: 4060120000	Spare relay Type: RSS113024 Orderno.: 4060120000

Ordering data

	60 V UC	120 V UC	230 V UC	120 V AC RC	230 V AC RC
<b>Input</b>					
Rated control voltage	60 V UC ±10 %	120 V UC ±10 %	230 V UC ±10%	120 V AC ±10 %	230 V AC ±10 %
Rated current AC / DC	6.1 mA / 3,3 mA	4 mA / 3.5 mA	3.5 mA / 2.9 mA	7 mA /	10.1 mA /
Power rating	360 mW	0.48 VA, 420 mW	0.8 VA, 700 mW	0.84 VA	2.3 VA
Pull-in/drop-out voltage, typ.	37 V / 10 V AC 40 V / 10 V DC	79 V / 60 V AC 98 V / 62 V DC	159 V / 89 V AC 159 V / 89 V DC	79 V / 60 V AC	145 V / 85 V AC
Pull-in/drop-out current, typ.		4 mA / 2.5 mA AC	2.2 mA / 1.3 mA AC 1.7 mA / 0.7 mA DC	4 mA / 2.5 mA AC	9.13 mA / 4.78 mA AC
Status indicator	Green LED	Green LED	Green LED	Green LED	Green LED
Protective circuit	Rectifier	Rectifier	Rectifier	Rectifier	Rectifier
<b>Output</b>					
Switch-on delay	< 6 ms	< 8 ms	< 22 ms	< 5.3 ms	< 22 ms
Switch-off delay	< 6.5 ms	< 7 ms	< 30 ms	< 4 ms	< 30 ms

Ordering data

Screw connection	Type	TRS 60VUC 1CO	TRS 120VUC 1CO	TRS 230VUC 1CO	TRS 120VAC RC 1CO	TRS 230VAC RC 1CO
	Order No.	<b>1122800000</b>	<b>1122810000</b>	<b>1122820000</b>	<b>1122830000</b>	<b>1122840000</b>
Tension clamp conn.	Type	TRZ 60VUC 1CO	TRZ 120VUC 1CO	TRZ 230VUC 1CO	TRZ 120VAC RC 1CO	TRZ 230VAC RC 1CO
	Order No.	<b>1122910000</b>	<b>1122920000</b>	<b>1122930000</b>	<b>1122940000</b>	<b>1122950000</b>
<b>Note</b>		Spare relay Type: RSS113060 Orderno.: 4061630000	Spare relay Type: RSS113060 Orderno.: 4061630000	Spare relay Type: RSS113060 Orderno.: 4061630000	Spare relay Type: RSS113060 Orderno.: 4061630000	Spare relay Type: RSS113060 Orderno.: 4061630000

**1 CO contact with hard gold-plated contacts**  
**AC/DC/UC coil**

- Space saving, just 6.4 mm modular width
- AgNi contact with gold plating
- Screw and tension clamp connection

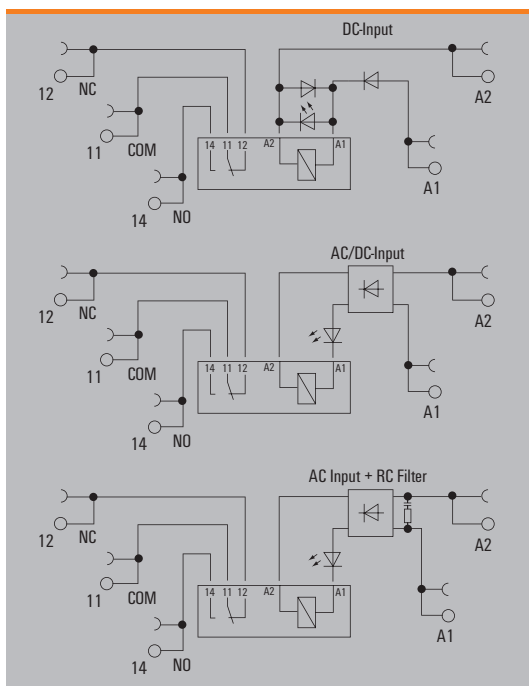
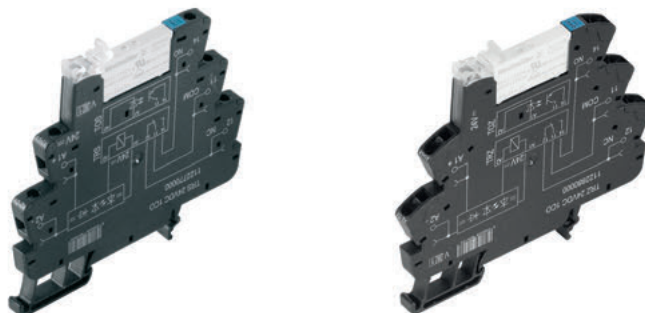

**Technical data**

<b>Output</b>			
Rated switching voltage / Continuous current	250 V AC / 6 A		
Max. switching voltage, AC	250 V		
Inrush current	20 A / 20 ms		
Min. switching power	1 V / 1 mA		
DC / AC Switching capacity (resistive), max.	144 W @ 24 V / 1500 VA		
Contact material	AgNi 5µm Au		
Mechanical service life	5 x 10 <sup>6</sup> switching cycles		
Max. switching frequency at rated load	0.1 Hz		
<b>Rated data</b>			
Ambient temperature (operational)	-40 °C...60 °C		
Storage temperature	-40 °C...85 °C		
Humidity	5-95% rel. humidity, T <sub>v</sub> = 40°C, no condensation		
Approvals	CE, cULus, EAC, GL		
<b>Insulation coordination (EN 50178)</b>			
Rated voltage	300 V		
Impulse withstand voltage	6 kV (1.2/50 µs)		
Dielectric strength input - output	4 kV <sub>eff</sub> / 1 min.		
Dielectric strength, contact / contact			
Dielectric strength to mounting rail	4 kV <sub>eff</sub> / 1 min.		
Creepage and clearance distance input - output	≥ 5.5 mm		
Overtension category	III		
Pollution degree	2		
<b>Dimensions</b>			
Clamping range (nominal / min. / max.)	mm <sup>2</sup>	<b>Screw connection</b>	<b>Tension clamp connection</b>
		1.5 / 0.14 / 2.5	1.5 / 0.14 / 2.5
Depth x width x height		88 / 6.4 / 90	88 / 6.4 / 90
<b>Note</b>			
Accessories and dimensional drawings: refer to the TERMSERIES Accessories page.			

**Applications**

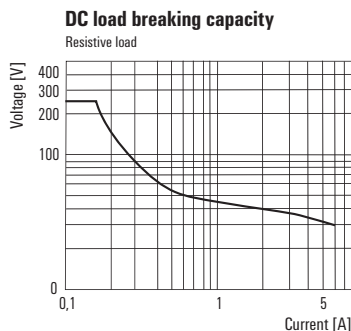
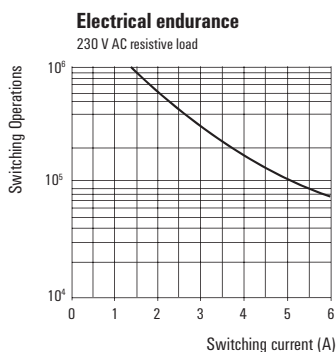

1 CO contact with hard gold-plated contacts  
AC/DC/UC coil

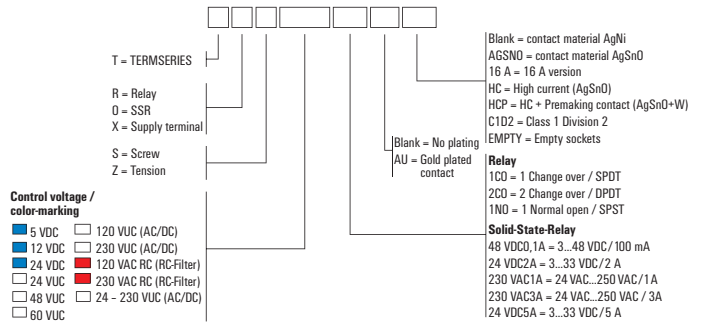

Ordering data

	5 V DC	12 V DC	24 V DC	24 V UC	48 V UC
<b>Input</b>					
Rated control voltage	5 V DC ±20 %	12 V DC ±20 %	24 V DC ±20 %	24 V UC ±10 %	48 V UC ±10 %
Rated current AC / DC	/ 35.8 mA	/ 18 mA	/ 10 mA	11.7 mA / 6.4 mA	8 mA / 7 mA
Power rating	200 mW	210 mW	240 mW	270 mVA / 154 mW	240 mVA / 192 mW
Pull-in/drop-out voltage, typ.	3.3 V / 1 V DC	8 V / 2 V DC	16 V / 4 V DC	16.5 V / 5.5 V AC 16.5 V / 5.5 V DC	29 V / 10 V AC 29 V / 10 V DC
Pull-in/drop-out current, typ.	21.6 mA / 8 mA DC	9 mA / 3 mA DC	7 mA / 2 mA DC	4 mA / 1.2 mA AC 4 mA / 1.2 mA DC	4 mA / 1.2 mA AC 4 mA / 1.2 mA DC
Status indicator	Green LED	Green LED	Green LED	Green LED	Green LED
Protective circuit	Integrated free-wheel diode, Reverse polarity protection	Integrated free-wheel diode, Reverse polarity protection	Integrated free-wheel diode, Reverse polarity protection	Rectifier	Rectifier
<b>Output</b>					
Switch-on delay	< 8 ms	< 7 ms	< 6 ms	< 4 ms	< 8 ms
Switch-off delay	< 4 ms	< 8 ms	< 7 ms	< 1.2 ms	< 4 ms

Ordering data

Screw connection	Type TR5 5VDC 1CO AU	Type TR5 12VDC 1CO AU	Type TR5 24VDC 1CO AU	Type TR5 24VUC 1CO AU	Type TR5 48VUC 1CO AU
Order No.	1122980000	1122990000	1123000000	1123010000	1123020000
Tension clamp conn.	Type TRZ 5VDC 1CO AU	Type TRZ 12VDC 1CO AU	Type TRZ 24VDC 1CO AU	Type TRZ 24VUC 1CO AU	Type TRZ 48VUC 1CO AU
Order No.	1123100000	1123110000	1123120000	1123130000	1123140000
<b>Note</b>	Spare relay Type: RSS112005 Orderno.: 1174540000	Spare relay Type: RSS112012 Orderno.: 1220670000	Spare relay Type: RSS112024 Orderno.: 4061590000	Spare relay Type: RSS112024 Orderno.: 4061590000	Spare relay Type: RSS112024 Orderno.: 4061590000

Ordering data

	60 V UC	120 V UC	230 V UC	120 V AC RC	230 V AC RC
<b>Input</b>					
Rated control voltage	60 V UC ±10 %	120 V UC ±10 %	230 V UC ±10%	120 V AC ±10 %	230 V AC ±10 %
Rated current AC / DC	6.1 mA / 3.3 mA	4 mA / 3.5 mA	3.5 mA / 2.9 mA	7 mA /	10.1 mA /
Power rating	360 mW	0.48 VA, 420 mW	0.8 VA, 700 mW	0.84 VA	2.3 VA
Pull-in/drop-out voltage, typ.	37 V / 10 V AC 40 V / 10 V DC	79 V / 60 V AC 98 V / 62 V DC	159 V / 89 V AC 159 V / 89 V DC	79 V / 60 V AC	145 V / 85 V AC
Pull-in/drop-out current, typ.		4 mA / 2.5 mA AC	2.2 mA / 1.3 mA AC 1.7 mA / 0.7 mA DC	4 mA / 2.5 mA AC	9.13 mA / 4.78 mA AC
Status indicator	Green LED	Green LED	Green LED	Green LED	Green LED
Protective circuit	Rectifier	Rectifier	Rectifier	Rectifier	Rectifier
<b>Output</b>					
Switch-on delay	< 6 ms	< 8 ms	< 22 ms	< 5.3 ms	< 22 ms
Switch-off delay	< 6.5 ms	< 7 ms	< 30 ms	< 4 ms	< 30 ms

Ordering data

Screw connection	Type TR5 60VUC 1CO AU	Type TRZ 120VUC 1CO AU	Type TR5 230VUC 1CO AU	Type TR5 120VAC RC 1CO AU	Type TR5 230VAC RC 1CO AU
Order No.	1123030000	1123170000	1123050000	1123070000	1123080000
Tension clamp conn.	Type TRZ 60VUC 1CO AU	Type TR5 120VUC 1CO AU	Type TRZ 230VUC 1CO AU	Type TRZ 120VAC RC 1CO AU	Type TRZ 230VAC RC 1CO AU
Order No.	1123150000	1123040000	1123180000	1123190000	1123200000
<b>Note</b>	Spare relay Type: RSS112060 Orderno.: 4061600000	Spare relay Type: RSS112060 Orderno.: 4061600000	Spare relay Type: RSS112060 Orderno.: 4061600000	Spare relay Type: RSS112060 Orderno.: 4061600000	Spare relay Type: RSS112060 Orderno.: 4061600000

1 CO contact

multi-voltage input

- Space saving, just 6.4 mm modular width
- AgNi contact
- Screw and tension clamp connection
- Multi-voltage input: 24 to 230 V UC in one module

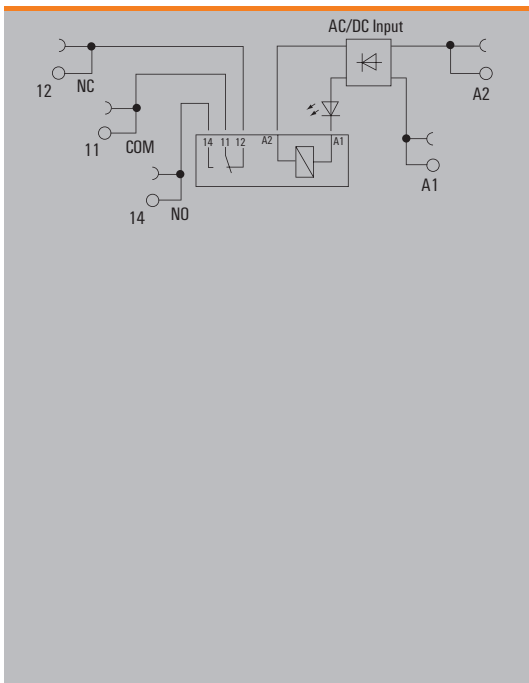
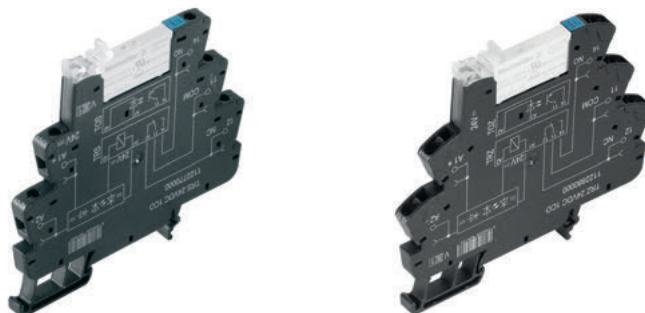

Technical data

<b>Output</b>		
Rated switching voltage / Continuous current	250 V AC / 6 A	
Max. switching voltage, AC	250 V	
Inrush current	20 A / 20 ms	
Min. switching power	100 mA / 5 V, 12 V / 10 mA, 24 V / 1 mA	
DC / AC Switching capacity (resistive), max.	144 W @ 24 V / 1500 VA	
Contact material	AgNi	
Mechanical service life	5 x 10 <sup>6</sup> switching cycles	
Max. switching frequency at rated load	0.1 Hz	
<b>Rated data</b>		
Ambient temperature (operational)	-40 °C...60 °C	
Storage temperature	-40 °C...85 °C	
Humidity	5-95% rel. humidity, T <sub>v</sub> = 40°C, no condensation	
Approvals	CE, cULus, EAC, GL	
<b>Insulation coordination (EN 50178)</b>		
Rated voltage	300 V	
Impulse withstand voltage	6 kV (1.2/50 µs)	
Dielectric strength input - output	4 kV <sub>eff</sub> / 1 min.	
Dielectric strength, contact / contact		
Dielectric strength to mounting rail	4 kV <sub>eff</sub> / 1 min.	
Creepage and clearance distance input - output	≥ 5.5 mm	
Overvoltage category	III	
Pollution degree	2	
<b>Dimensions</b>		
	<b>Screw connection</b>	<b>Tension clamp connection</b>
Clamping range (nominal / min. / max.)	mm <sup>2</sup> 1.5 / 0.14 / 2.5	1.5 / 0.14 / 2.5
Depth x width x height	mm 88 / 6.4 / 90	88 / 6.4 / 90
<b>Note</b>		
Accessories and dimensional drawings: refer to the TERMSERIES Accessories page.		

Ordering data

<b>Input</b>	
Rated control voltage	24...230 V UC ±10 %
Rated current AC / DC	4 mA @ 230 V AC ±10 %, 28 mA @ 24 V AC ±10 % / 22 mA @ 24 V DC ±10 %
Power rating	530 mW @ 24 V DC, 930 mVA @ 230 V AC
Pull-in/drop-out voltage, typ.	11.5 V / 6 V AC, 11.5 V / 5 V DC
Pull-in/drop-out current, typ.	
Status indicator	Green LED
Protective circuit	Rectifier
<b>Output</b>	
Switch-on delay	< 22 ms
Switch-off delay	< 100 ms

24 V - 230 V UC

<b>Ordering data</b>	
Screw connection	Type TRS 24-230VUC 1CO
Order No.	1122850000
Tension clamp conn.	Type TRZ 24-230VUC 1CO
Order No.	1122970000
<b>Note</b>	
Spare relay Type: RSS113024 Orderno.: 4060120000	

**1 CO contact with hard gold-plated contacts**  
**multi-voltage input**

- Space saving, just 6.4 mm modular width
- AgNi contact with gold plating
- Screw and tension clamp connection
- Multi-voltage input: 24 to 230 V UC in one module

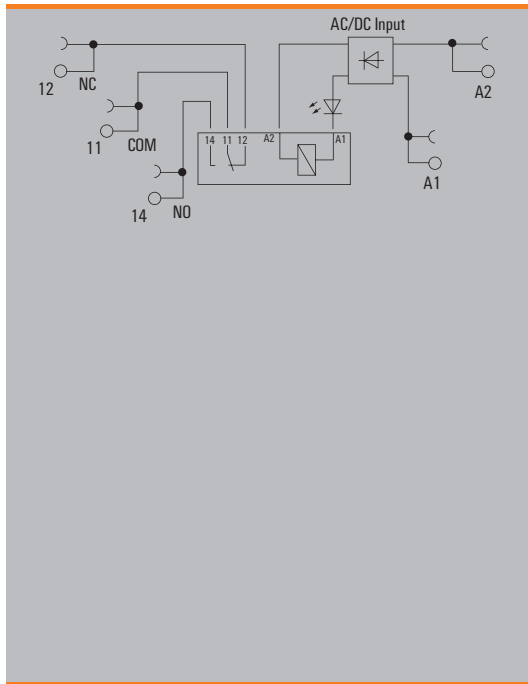
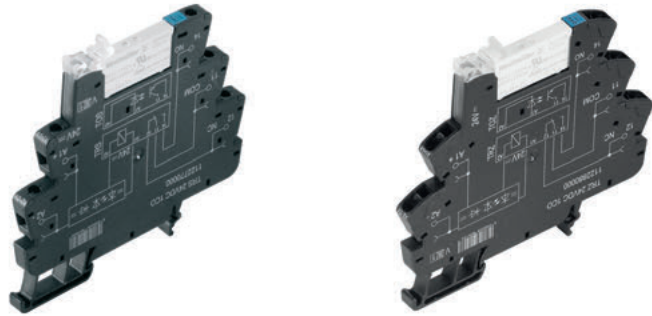

**Technical data**

<b>Output</b>		
Rated switching voltage / Continuous current	250 V AC / 6 A	
Max. switching voltage, AC	250 V	
Inrush current	20 A / 20 ms	
Min. switching power	1 V / 1 mA	
DC / AC Switching capacity (resistive), max.	144 W @ 24 V / 1500 VA	
Contact material	AgNi 5µm Au	
Mechanical service life	5 x 10 <sup>6</sup> switching cycles	
Max. switching frequency at rated load	0.1 Hz	
<b>Rated data</b>		
Ambient temperature (operational)	-40 °C...60 °C	
Storage temperature	-40 °C...85 °C	
Humidity	5-95% rel. humidity, T <sub>v</sub> = 40°C, no condensation	
Approvals	CE, cULus, EAC, GL	
<b>Insulation coordination (EN 50178)</b>		
Rated voltage	300 V	
Impulse withstand voltage	6 kV (1.2/50 µs)	
Dielectric strength input - output	4 kV <sub>eff</sub> / 1 min.	
Dielectric strength, contact / contact		
Dielectric strength to mounting rail	4 kV <sub>eff</sub> / 1 min.	
Creepage and clearance distance input - output	≥ 5.5 mm	
Overvoltage category	III	
Pollution degree	2	
<b>Dimensions</b>		
	<b>Screw connection</b>	<b>Tension clamp connection</b>
Clamping range (nominal / min. / max.)	mm <sup>2</sup> 1.5 / 0.14 / 2.5	1.5 / 0.14 / 2.5
Depth x width x height	mm 88 / 6.4 / 90	88 / 6.4 / 90
<b>Note</b>		
Accessories and dimensional drawings: refer to the TERMSERIES Accessories page.		

**Ordering data**

<b>Input</b>	
Rated control voltage	24...230 V UC ±10 %
Rated current AC / DC	4 mA @ 230 V AC ±10 %, 28 mA @ 24 V AC ±10 % / 22 mA @ 24 V DC ±10 %
Power rating	530 mW @ 24 V DC, 930 mVA @ 230 V AC
Pull-in/drop-out voltage, typ.	11.5 V / 6 V AC, 11.5 V / 5 V DC
Pull-in/drop-out current, typ.	
Status indicator	Green LED
Protective circuit	Rectifier
<b>Output</b>	
Switch-on delay	< 22 ms
Switch-off delay	< 100 ms

<b>Ordering data</b>	
Screw connection	Type TRS 24-230VUC 1CO AU
Order No.	<b>1123090000</b>
Tension clamp conn.	Type TRZ 24-230VUC 1CO AU
Order No.	<b>1123210000</b>
<b>Note</b>	
Spare relay Type: RSS112024 Orderno.: 4061590000	

1 NO contact (actuator)

- Space-saving, only 6.4 mm wide
- AgNi contact
- Screw and tension clamp connection
- 24 V DC actuator version:  
Bridgeable, potential-free connection in the output (CC)

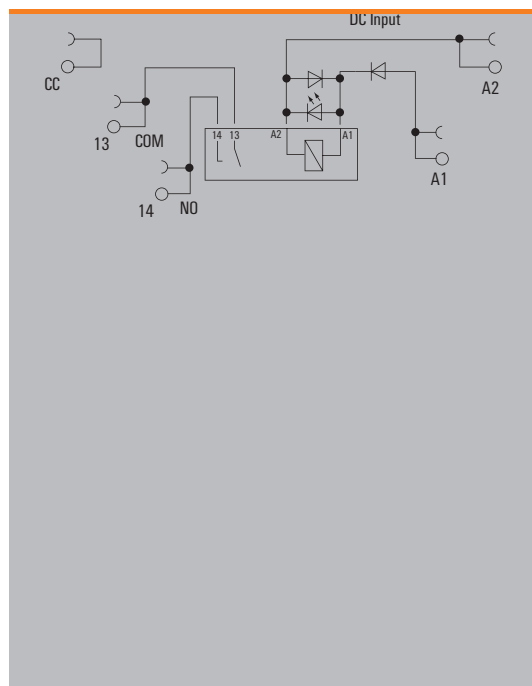
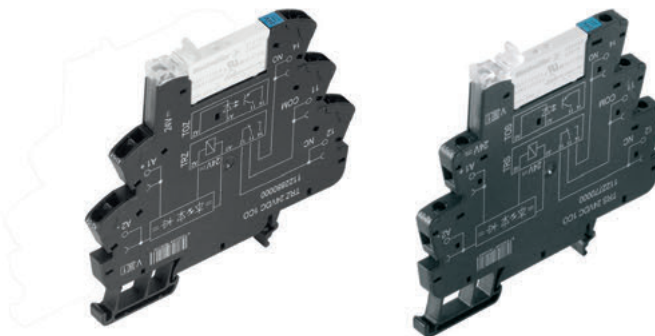

Technical data

<b>Output</b>			
Rated switching voltage / Continuous current	250 V AC / 6 A		
Max. switching voltage, AC	250 V		
Inrush current	20 A / 20 ms		
Min. switching power	100 mA / 5 V, 12 V / 10 mA, 24 V / 1 mA		
DC / AC Switching capacity (resistive), max.	144 W @ 24 V / 1500 VA		
Contact material	AgNi		
Mechanical service life	5 x 10 <sup>6</sup> switching cycles		
Max. switching frequency at rated load	0.1 Hz		
<b>Rated data</b>			
Ambient temperature (operational)	-40 °C...60 °C		
Storage temperature	-40 °C...85 °C		
Humidity	5-95% rel. humidity, T <sub>v</sub> = 40°C, no condensation		
Approvals	CE, EAC		
<b>Insulation coordination (EN 50178)</b>			
Rated voltage	300 V		
Impulse withstand voltage	6 kV (1.2/50 µs)		
Dielectric strength input - output	4 kV <sub>eff</sub> / 1 min.		
Dielectric strength, contact / contact			
Dielectric strength to mounting rail	4 kV <sub>eff</sub> / 1 min.		
Creepage and clearance distance input - output	≥ 5.5 mm		
Overtoltage category	III		
Pollution degree	2		
<b>Dimensions</b>			
Clamping range (nominal / min. / max.)	mm <sup>2</sup>	<b>Screw connection</b>	<b>Tension clamp connection</b>
		1.5 / 0.14 / 1.5	1.5 / 0.14 / 1.5
Depth x width x height	mm	88 / 6.4 / 90	88 / 6.4 / 90
<b>Note</b>		Accessories and dimensional drawings: refer to the TERMSERIES Accessories page.	

Ordering data

Input	
Rated control voltage	24 V DC ±20 %
Rated current AC / DC	/ 10 mA
Power rating	240 mW
Pull-in/drop-out voltage, typ.	16 V / 4 V DC
Pull-in/drop-out current, typ.	7 mA / 2 mA DC
Status indicator	Green LED
Protective circuit	Integrated free-wheel diode, Reverse polarity protection
Output	
Switch-on delay	< 6 ms
Switch-off delay	< 7 ms

24 V DC ACT

Ordering data	
Screw connection	Type TRS 24VDC ACT
Order No.	1381900000
Tension clamp conn.	Type TRZ 24VDC ACT
Order No.	1391670000
Note	

**1 CO contact (AgSnO)**

- Space-saving, only 6.4 mm wide
- AgSnO contact
- For capacitive and inductive loads
- Screw and tension clamp connection

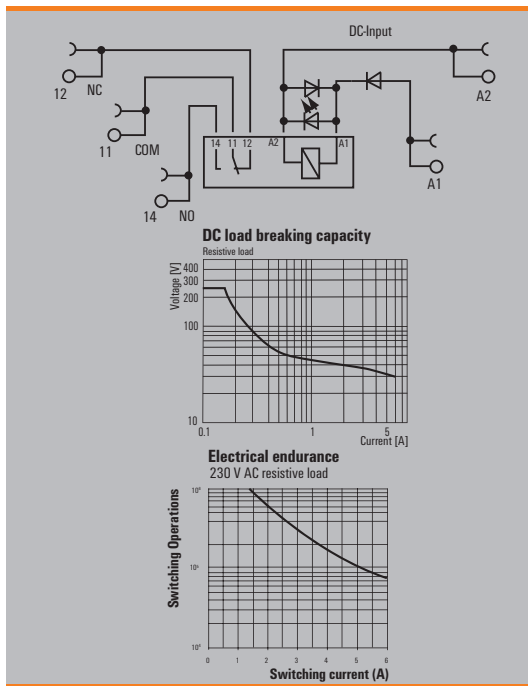
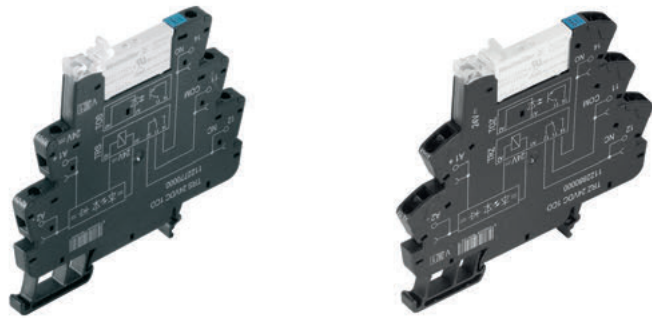

**Technical data**

Output			
Rated switching voltage / Continuous current	250 V AC / 6 A		
Max. switching voltage, AC	250 V		
Inrush current	20 A / 20 ms		
Min. switching power	100 mA / 5 V, 12 V / 10 mA, 24 V / 1 mA		
DC / AC Switching capacity (resistive), max.	144 W @ 24 V / 1500 VA		
Contact material	AgSnO		
Mechanical service life	5 x 10 <sup>6</sup> switching cycles		
Max. switching frequency at rated load	0.1 Hz		
Rated data			
Ambient temperature (operational)	-40 °C...60 °C		
Storage temperature	-40 °C...85 °C		
Humidity	5-95% rel. humidity, T <sub>v</sub> = 40°C, no condensation		
Approvals	CE		
Insulation coordination (EN 50178)			
Rated voltage	300 V		
Impulse withstand voltage	6 kV (1.2/50 µs)		
Dielectric strength input - output	4 kV <sub>eff</sub> / 1 min.		
Dielectric strength, contact / contact	4 kV <sub>eff</sub> / 1 min.		
Dielectric strength to mounting rail	4 kV <sub>eff</sub> / 1 min.		
Creepage and clearance distance input - output	≥ 5.5 mm		
Oversoltage category	III		
Pollution degree	2		
Dimensions		Screw connection	Tension clamp connection
Clamping range (nominal / min. / max.)	mm <sup>2</sup>	1.5 / 0.14 / 2.5	1.5 / 0.14 / 2.5
Depth x width x height	mm	88 / 6.4 / 90	88 / 6.4 / 90
Note			

**Ordering data**

Input	
Rated control voltage	24 V DC ±20 %
Rated current AC / DC	/ 10 mA
Power rating	240 mW
Pull-in/drop-out voltage, typ.	16 V / 4 V DC
Pull-in/drop-out current, typ.	7 mA / 2 mA DC
Status indicator	Green LED
Protective circuit	Integrated free-wheel diode, Reverse polarity protection
Output	
Switch-on delay	< 6 ms
Switch-off delay	< 7 ms

Ordering data	
Screw connection	Type TRS 24VDC 1CO AGSNO
Order No.	<b>1984540000</b>
Tension clamp conn.	Type TRZ 24VDC 1CO AGSNO
Order No.	<b>1984550000</b>
Note	

1 CO contact

AC / DC / UC coil

- Space-saving, 12.8 mm wide
- 16 A AgNi contact
- Internal cross-connection of the output terminals
- Screw and tension clamp connection

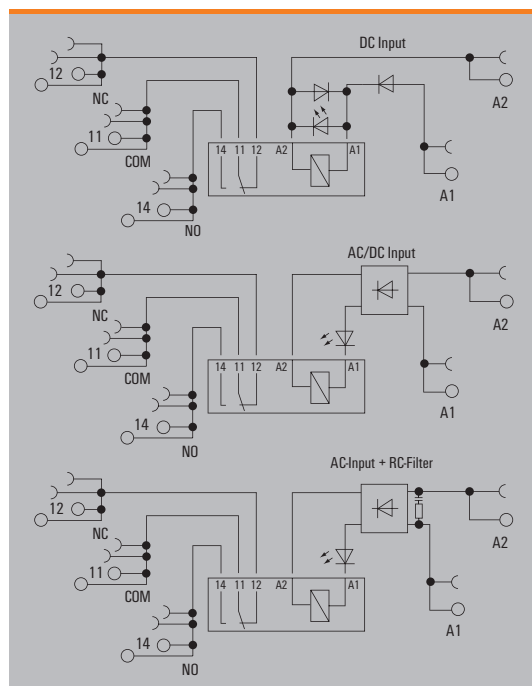
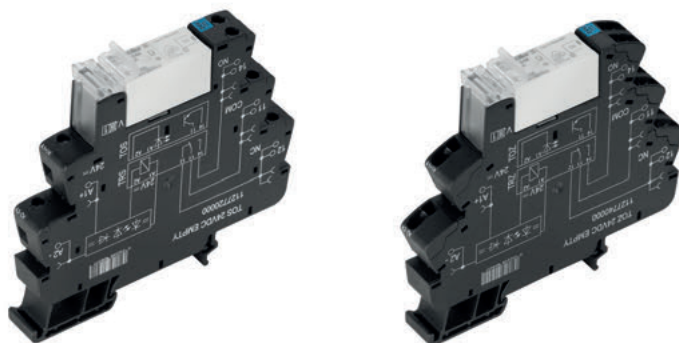

Technical data

<b>Output</b>			
Rated switching voltage / Continuous current	250 V AC / 16 A		
Max. switching voltage, AC	250 V		
Inrush current	30 A / 4 s		
Min. switching power	100 mA / 5 V, 10 V / 10 mA		
DC / AC Switching capacity (resistive), max.	384 W @ 24 V / 4000 VA		
Contact material	AgNi		
Mechanical service life	30 x 10 <sup>6</sup> switching cycles		
Max. switching frequency at rated load	0.1 Hz		
<b>Rated data</b>			
Ambient temperature (operational)	-40 °C...60 °C		
Storage temperature	-40 °C...85 °C		
Humidity	5-95% rel. humidity, T <sub>v</sub> = 40°C, no condensation		
Approvals	CE		
<b>Insulation coordination (EN 50178)</b>			
Rated voltage	300 V		
Impulse withstand voltage	6 kV (1.2/50 µs)		
Dielectric strength input - output	1.2 kV <sub>eff</sub> / 5 s		
Dielectric strength, contact / contact			
Dielectric strength to mounting rail	4 kV <sub>eff</sub> / 1 min.		
Creepage and clearance distance input - output	≥ 5.5 mm		
Overtoltage category	III		
Pollution degree	2		
<b>Dimensions</b>			
Clamping range (nominal / min. / max.)	mm <sup>2</sup>	<b>Screw connection</b>	<b>Tension clamp connection</b>
		1.5 / 0.14 / 2.5	1.5 / 0.14 / 2.5
Depth x width x height	mm	88 / 12.8 / 90	88 / 12.8 / 90
<b>Note</b>			

Applications

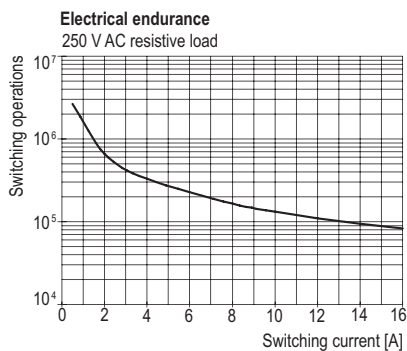
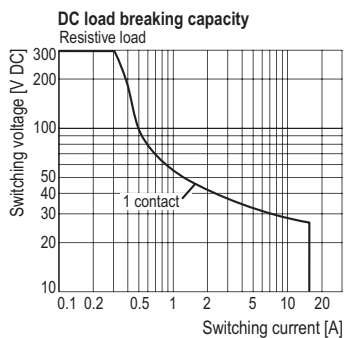



1 CO contact  
AC / DC / UC coil

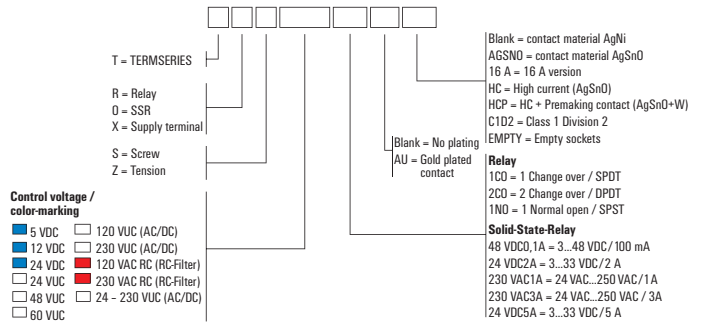

Ordering data

	5 V DC	12 V DC	24 V DC	24 V UC	48 V UC
<b>Input</b>					
Rated control voltage	5 V DC ±20 %	12 V DC ±20 %	24 V DC ±20 %	24 V UC ±10 %	48 V UC ±10 %
Rated current AC / DC	/ 80 mA	/ 33.3 mA	/ 20 mA	16 mA / 14 mA	9 mA / 7 mA
Power rating	400 mW	420 mW	480 mW	390 mVA / 350 mW	340 mW / 0.4 VA
Pull-in/drop-out voltage, typ.	3 V / 1.6 V DC	8 V / 3 V DC	18 V / 3.5 V DC	16 V / 9 V AC 18 V / 8 V DC	29 V / 11 V AC 33 V / 11 V DC
Pull-in/drop-out current, typ.	21.6 mA / 8 mA DC	21 mA / 5 mA DC	10 mA / 3 mA DC	11 mA / 4 mA AC 10 mA / 2 mA DC	6 mA / 3 mA AC 5 mA / 1.5 mA DC
Status indicator	Green LED	Green LED	Green LED	Green LED	Green LED
Protective circuit	Integrated free-wheel diode, Reverse polarity protection	Integrated free-wheel diode, Reverse polarity protection	Integrated free-wheel diode, Reverse polarity protection	Rectifier	Rectifier
<b>Output</b>					
Switch-on delay	< 11 ms	< 11 ms	< 11 ms	< 11 ms	< 11 ms
Switch-off delay	< 7 ms	< 8 ms	< 10 ms	< 7 ms	< 7 ms

Ordering data

Screw connection	Type	TRS 5VDC 1CO 16A	TRS 12VDC 1CO 16A	TRS 24VDC 1CO 16A	TRS 24VUC 1CO 16A	TRS 48VUC 1CO 16A
	Order No.	1479650000	1479670000	1479680000	1479690000	1479700000
Tension clamp conn.	Type	TRZ 5VDC 1CO 16A	TRZ 12VDC 1CO 16A	TRZ 24VDC 1CO 16A	TRZ 24VUC 1CO 16A	TRZ 48VUC 1CO 16A
	Order No.	1479800000	1479820000	1479840000	1479850000	1479870000
<b>Note</b>						

Ordering data

	60 V UC	120 V UC	230 V UC	120 V AC RC	230 V AC RC
<b>Input</b>					
Rated control voltage	60 V UC ±10 %	120 V UC ±10 %	230 V UC ±5 %	120 V AC ±10 %	230 V AC ±5 %
Rated current AC / DC	8 mA / 6.1 mA	3.5 mA / 3.5 mA	4 mA / 4 mA	5.5 mA /	10 mA /
Power rating	480 mVA / 360 mW	420 mVA / 420 mW	920 mVA / 920 mW	0.73 VA	2.3 VA
Pull-in/drop-out voltage, typ.	36 V / 13 V AC 40 V / 14 V DC	64 V / 26 V AC 69 V / 22 V DC	112 V / 43 V AC 129 V / 36 V DC	65 V / 23 V AC	112 V / 45 V AC
Pull-in/drop-out current, typ.	5 mA / 2.5 mA AC 4 mA / 1.2 mA DC	2 mA / 1 mA AC 2 mA / 1 mA DC	2 mA / 1 mA AC 2 mA / 1 mA DC	3.5 mA / 1 mA AC	5 mA / 2 mA AC
Status indicator	Green LED	Green LED	Green LED	Green LED	Green LED
Protective circuit	Rectifier	Rectifier	Rectifier	Rectifier	Rectifier
<b>Output</b>					
Switch-on delay	< 11 ms	< 11 ms	< 14 ms	< 11 ms	< 14 ms
Switch-off delay	< 7 ms	< 7 ms	< 22 ms	< 7 ms	< 12 ms

Ordering data

Screw connection	Type	TRS 60VUC 1CO 16A	TRS 120VUC 1CO 16A	TRS 230VUC 1CO 16A	TRS 120VAC RC 1CO 16A	TRS 230VAC RC 1CO 16A
	Order No.	1479710000	1479730000	1479740000	1479750000	1479760000
Tension clamp conn.	Type	TRZ 60VUC 1CO 16A	TRZ 120VUC 1CO 16A	TRZ 230VUC 1CO 16A	TRZ 120VAC RC 1CO 16A	TRZ 230VAC RC 1CO 16A
	Order No.	1479880000	1479890000	1479900000	1479910000	1479920000
<b>Note</b>						

1 CO contact

Variable-voltage input

- Space-saving, 12.8 mm wide
- 16 A AgNi contact
- Internal cross-connection of the output terminals
- Screw and tension clamp connection
- Multi-voltage input: 24...230 V UC in one module

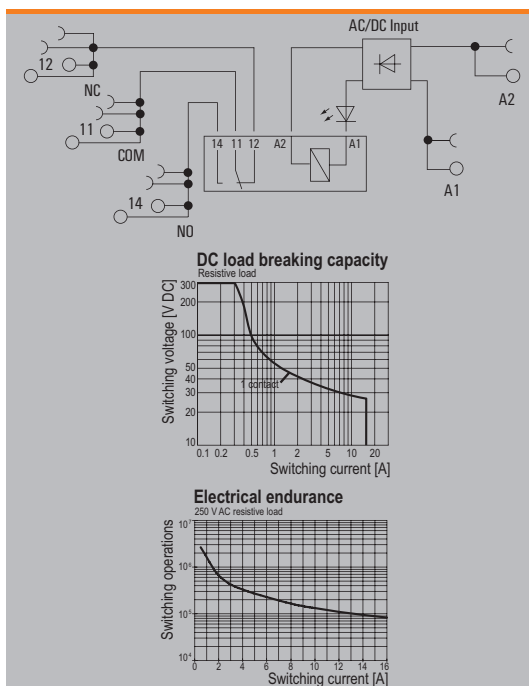
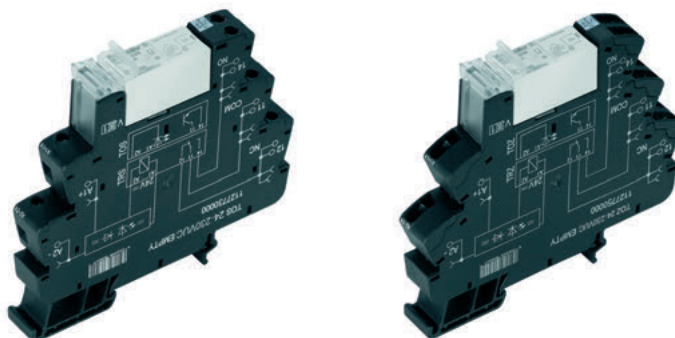

Technical data

<b>Output</b>		
Rated switching voltage / Continuous current	250 V AC / 16 A	
Max. switching voltage, AC	250 V	
Inrush current	30 A / 4 s	
Min. switching power	100 mA / 5 V, 10 V / 10 mA	
DC / AC Switching capacity (resistive), max.	384 W @ 24 V / 4000 VA	
Contact material	AgNi	
Mechanical service life	30 x 10 <sup>6</sup> switching cycles	
Max. switching frequency at rated load	0.1 Hz	
<b>Rated data</b>		
Ambient temperature (operational)	-40 °C...60 °C	
Storage temperature	-40 °C...85 °C	
Humidity	5-95% rel. humidity, T <sub>v</sub> = 40°C, no condensation	
<b>Approvals</b>		
<b>Insulation coordination (EN 50178)</b>		
Rated voltage	300 V	
Impulse withstand voltage	6 kV (1.2/50 µs)	
Dielectric strength input - output	1.2 kV <sub>eff</sub> / 5 s	
Dielectric strength, contact / contact		
Dielectric strength to mounting rail	4 kV <sub>eff</sub> / 1 min.	
Creepage and clearance distance input - output	≥ 5.5 mm	
Overvoltage category	III	
Pollution degree	2	
<b>Dimensions</b>		
	<b>Screw connection</b>	<b>Tension clamp connection</b>
Clamping range (nominal / min. / max.)	mm <sup>2</sup> 1.5 / 0.14 / 2.5	1.5 / 0.14 / 2.5
Depth x width x height	mm 88 / 12.8 / 90	88 / 12.8 / 90
<b>Note</b>		

Ordering data

<b>Input</b>	
Rated control voltage	24...230 V UC ±10 %
Rated current AC / DC	6 mA @ 230 V UC / 45 mA @ 24 VUC
Power rating	1.08 W @ 24 V UC, 1.38 W @ 230 V UC
Pull-in/drop-out voltage, typ.	16 V / 6 V AC 16 V / 5 V DC
Pull-in/drop-out current, typ.	
Status indicator	Green LED
Protective circuit	Rectifier
<b>Output</b>	
Switch-on delay	< 22 ms
Switch-off delay	< 125 ms

24 V - 230 V UC

<b>Ordering data</b>	
Screw connection	Type TRS 24-230VUC 1CO 16A
Order No.	1479770000
Tension clamp conn.	Type TRZ 24-230VUC 1CO 16A
Order No.	1479930000
<b>Note</b>	



**TERMSERIES relay modules**
**1 NO contact, inrush power HC**

- Space-saving, 12.8 mm wide
- 16 A AgSnO contact
- Internal cross-connection of the output terminals
- Especially for inductive loads
- Screw and tension clamp connection
- Multi-voltage input: 24...230 V UC in one module

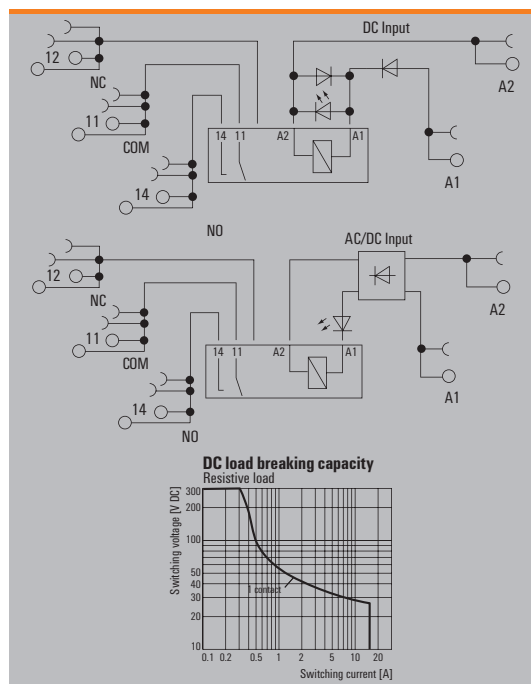
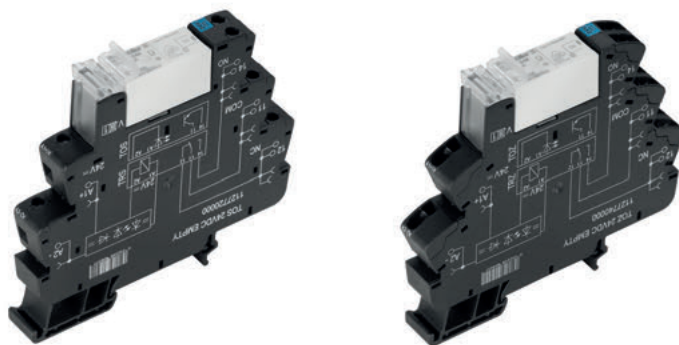
**Technical data**

Output	
Rated switching voltage / Continuous current	250 V AC / 16 A
Max. switching voltage, AC	250 V
Inrush current	
Min. switching power	1 W
DC / AC Switching capacity (resistive), max.	384 W @ 24 V / 4000 VA
Contact material	AgSnO
Mechanical service life	10 x 10 <sup>6</sup> switching cycles
Max. switching frequency at rated load	0.1 Hz
Rated data	
Ambient temperature (operational)	-40 °C...60 °C
Storage temperature	-40 °C...85 °C
Humidity	5-95% rel. humidity, T <sub>v</sub> = 40°C, no condensation
Approvals	
Insulation coordination (EN 50178)	
Rated voltage	300 V
Impulse withstand voltage	6 kV (1.2/50 µs)
Dielectric strength input - output	1.2 kV <sub>eff</sub> / 5 s
Dielectric strength, contact / contact	
Dielectric strength to mounting rail	4 kV <sub>eff</sub> / 1 min.
Creepage and clearance distance input - output	≥ 5.5 mm
Overtoltage category	III
Pollution degree	2
Dimensions	
Clamping range (nominal / min. / max.)	mm <sup>2</sup> 1.5 / 0.14 / 2.5
Depth x width x height	mm 88 / 12.8 / 90
	<b>Screw connection</b> 1.5 / 0.14 / 2.5
	<b>Tension clamp connection</b> 88 / 12.8 / 90
<b>Note</b>	

**Ordering data**

	24 V DC	24 - 230 V UC
<b>Input</b>		
Rated control voltage	24 V DC ±20 %	24...230 V UC ±10 %
Rated current AC / DC	/ 20 mA	6 mA @ 230 V UC / 45 mA @ 24 VUC
Power rating	480 mW	1.08 W @ 24 V UC, 1.38 W @ 230 V UC
Pull-in/drop-out voltage, typ.	18 V / 3.5 V DC	16 V / 6 V AC 16 V / 5 V DC
Pull-in/drop-out current, typ.		
Status indicator	Green LED	Green LED
Protective circuit	Integrated free-wheel diode, Reverse polarity protection	Rectifier
<b>Output</b>		
Switch-on delay	≤ 10 ms	< 22 ms
Switch-off delay	< 10 ms	< 125 ms

Ordering data			
Screw connection	Type	TRS 24VDC 1NO HC	TRS 24-230VUC 1NO HC
	Order No.	<b>1479780000</b>	<b>1479790000</b>
Tension clamp conn.	Type	TRZ 24VDC 1NO HC	TRZ 24-230VUC 1NO HC
	Order No.	<b>1479940000</b>	<b>1479950000</b>
<b>Note</b>			

**1 NO contact, inrush power HCP**

- Space-saving, only 12.8 mm wide
- 16 A AgSnO contact + leading tungsten contact
- Internal cross-connection of the output terminals
- Especially for capacitive loads
- Screw and tension clamp connection
- Multi-voltage input: 24–230 V UC in one module

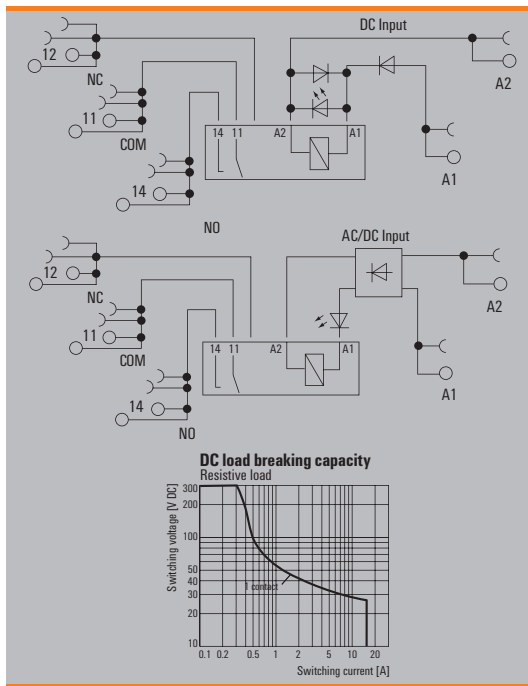
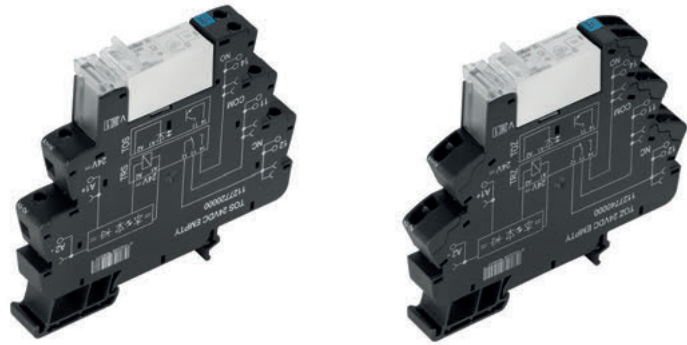

**Technical data**

<b>Output</b>			
Rated switching voltage / Continuous current	250 V AC / 16 A		
Max. switching voltage, AC	250 V		
Inrush current	165 A / 20 ms, 800 A / 200 µs		
Min. switching power	1 W		
DC / AC Switching capacity (resistive), max.	384 W @ 24 V / 4000 VA		
Contact material	AgSnO <sub>2</sub> + W		
Mechanical service life	5 x 10 <sup>6</sup> switching cycles		
Max. switching frequency at rated load	0.1 Hz		
<b>Rated data</b>			
Ambient temperature (operational)	-40 °C...60 °C		
Storage temperature	-40 °C...85 °C		
Humidity	5-95% rel. humidity, T <sub>v</sub> = 40°C, no condensation		
<b>Approvals</b>			
<b>Insulation coordination (EN 50178)</b>			
Rated voltage	300 V		
Impulse withstand voltage	6 kV (1.2/50 µs)		
Dielectric strength input - output	1.2 kV <sub>eff</sub> / 5 s		
Dielectric strength, contact / contact			
Dielectric strength to mounting rail	4 kV <sub>eff</sub> / 1 min.		
Creepage and clearance distance input - output	≥ 5.5 mm		
Overtoltage category	III		
Pollution degree	2		
<b>Dimensions</b>			
Clamping range (nominal / min. / max.)	mm <sup>2</sup>	<b>Screw connection</b>	<b>Tension clamp connection</b>
		1.5 / 0.14 / 2.5	1.5 / 0.14 / 2.5
Depth x width x height	mm	88 / 12.8 / 90	88 / 12.8 / 90
<b>Note</b>			

**Ordering data**

	24 V DC	24 V - 230 V UC
<b>Input</b>		
Rated control voltage	24 V DC ±20 %	24...230 V UC ±10 %
Rated current AC / DC	/ 20 mA	6 mA @ 230 V UC / 45 mA @ 24 VUC
Power rating	480 mW	1.08 W @ 24 V UC, 1.38 W @ 230 V UC
Pull-in/drop-out voltage, typ.	18 V / 3.5 V DC	16 V / 6 V AC 16 V / 5 V DC
Pull-in/drop-out current, typ.		
Status indicator	Green LED	Green LED
Protective circuit	Integrated free-wheel diode, Reverse polarity protection	Rectifier
<b>Output</b>		
Switch-on delay	≤ 10 ms	< 22 ms
Switch-off delay	< 10 ms	< 125 ms

Ordering data			
Screw connection	Type	TRS 24VDC 1NO HCP	TRS 24-230VUC 1NO HCP
	Order No.	<b>1479810000</b>	<b>1479830000</b>
Tension clamp conn.	Type	TRZ 24VDC 1NO HCP	TRZ 24-230VUC 1NO HCP
	Order No.	<b>1479970000</b>	<b>1479980000</b>
<b>Note</b>			

**2 CO contacts**  
**AC/DC/UC coil**

- Space saving, just 12.8 mm modular width
- AgNi contact
- Screw and tension clamp connection

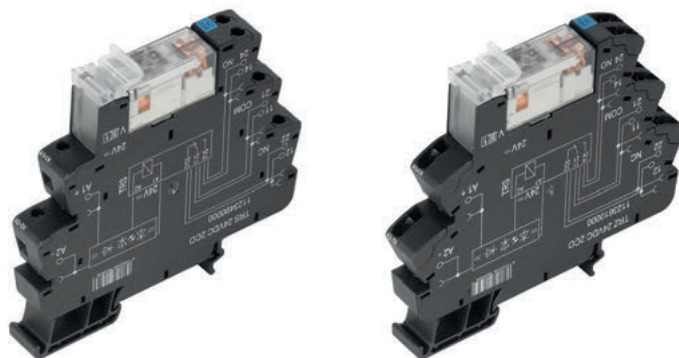

Relay modules and solid-state relays  
6 mm width

**A**

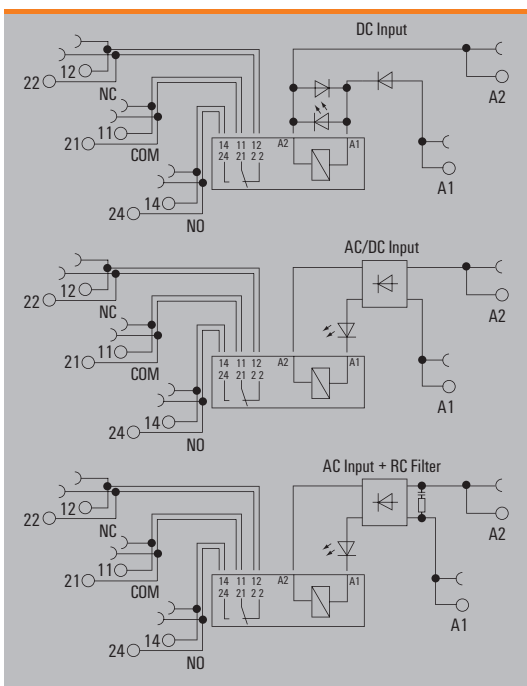

**Technical data**

<b>Output</b>			
Rated switching voltage / Continuous current	250 V AC / 8 A		
Max. switching voltage, AC	250 V		
Inrush current	15 A / 4 s		
Min. switching power	100 mA / 5 V, 10 V / 10 mA		
DC / AC Switching capacity (resistive), max.	192 W @ 24 V / 2000 VA		
Contact material	AgNi		
Mechanical service life	30 x 10 <sup>6</sup> switching cycles		
Max. switching frequency at rated load	0.1 Hz		
<b>Rated data</b>			
Ambient temperature (operational)	-40 °C...60 °C		
Storage temperature	-40 °C...85 °C		
Humidity	5-95% rel. humidity, T <sub>v</sub> = 40°C, no condensation		
Approvals	CE, cULus, EAC, GL		
<b>Insulation coordination (EN 50178)</b>			
Rated voltage	300 V		
Impulse withstand voltage	6 kV (1.2/50 µs)		
Dielectric strength input - output	1.2 kV <sub>eff</sub> / 5 s		
Dielectric strength, contact / contact			
Dielectric strength to mounting rail	4 kV <sub>eff</sub> / 1 min.		
Creepage and clearance distance input - output	≥ 5.5 mm		
Overtoltage category	III		
Pollution degree	2		
<b>Dimensions</b>			
Clamping range (nominal / min. / max.)	mm <sup>2</sup>	<b>Screw connection</b>	<b>Tension clamp connection</b>
		1.5 / 0.14 / 2.5	1.5 / 0.14 / 2.5
Depth x width x height	mm	88 / 12.8 / 90	88 / 12.8 / 90
<b>Note</b>			
Accessories and dimensional drawings: refer to the TERMSERIES Accessories page.			

**Applications**

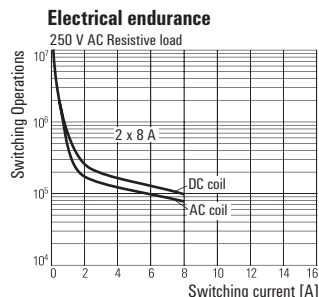
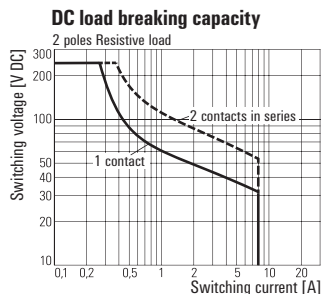

2 CO contacts  
AC/DC/UC coil

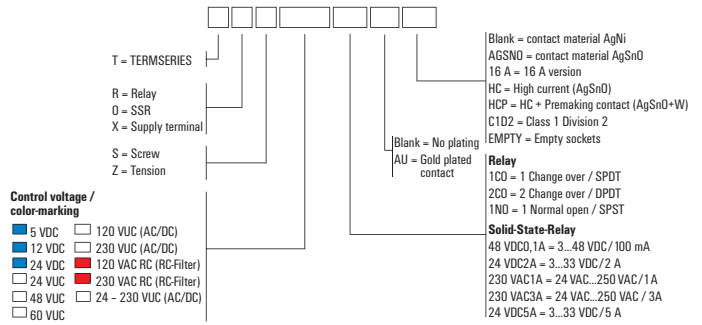

Ordering data

	5 V DC	12 V DC	24 V DC	24 V UC	48 V UC
<b>Input</b>					
Rated control voltage	5 V DC ±20 %	12 V DC ±20 %	24 V DC ±20 %	24 V UC ±10 %	48 V UC ±10 %
Rated current AC / DC	/ 80 mA	/ 33.3 mA	/ 20 mA	16 mA / 14 mA	9 mA / 7 mA
Power rating	400 mW	420 mW	480 mW	390 mVA / 350 mW	340 mW / 0.4 VA
Pull-in/drop-out voltage, typ.	3 V / 1.6 V DC	8 V / 3 V DC	18 V / 3.5 V DC	16 V / 9 V AC 18 V / 8 V DC	29 V / 11 V AC 33 V / 11 V DC
Pull-in/drop-out current, typ.	21.6 mA / 8 mA DC	21 mA / 5 mA DC	10 mA / 3 mA DC	11 mA / 4 mA AC 10 mA / 2 mA DC	6 mA / 3 mA AC 5 mA / 1.5 mA DC
Status indicator	Green LED	Green LED	Green LED	Green LED	Green LED
Protective circuit	Integrated free-wheel diode, Reverse polarity protection	Integrated free-wheel diode, Reverse polarity protection	Integrated free-wheel diode, Reverse polarity protection	Rectifier	Rectifier
<b>Output</b>					
Switch-on delay	< 11 ms	< 11 ms	< 11 ms	< 11 ms	< 11 ms
Switch-off delay	< 7 ms	< 8 ms	< 10 ms	< 7 ms	< 7 ms

<b>Ordering data</b>							
Screw connection	Type	TRS 5VDC 2CO	TRS 12VDC 2CO	TRS 24VDC 2CO	TRS 24VUC 2CO	TRS 48VUC 2CO	
Order No.		<b>1123470000</b>	<b>1123480000</b>	<b>1123490000</b>	<b>1123500000</b>	<b>1123510000</b>	
Tension clamp conn.	Type	TRZ 5VDC 2CO	TRZ 12VDC 2CO	TRZ 24VDC 2CO	TRZ 24VUC 2CO	TRZ 48VUC 2CO	
Order No.		<b>1123590000</b>	<b>1123600000</b>	<b>1123610000</b>	<b>1123620000</b>	<b>1123630000</b>	
<b>Note</b>							
	Spare relay	Type: RCL424005 Orderno.: 8693790000	Spare relay	Type: RCL424012 Orderno.: 4058560000	Spare relay	Type: RCL424024 Orderno.: 4058570000	
				Spare relay	Type: RCL424024 Orderno.: 4058570000	Spare relay	Type: RCL424048 Orderno.: 4058750000

Ordering data

	60 V UC	120 V UC	230 V UC	120 V AC RC	230 V AC RC
<b>Input</b>					
Rated control voltage	60 V UC ±10 %	120 V UC ±10 %	230 V UC ±5 %	120 V AC ±10 %	230 V AC ±5 %
Rated current AC / DC	8 mA / 6.1 mA	3.5 mA / 3.5 mA	4 mA / 4 mA	5.5 mA /	10 mA /
Power rating	480 mVA / 360 mW	420 mVA / 420 mW	920 mVA / 920 mW	0.73 VA	2.3 VA
Pull-in/drop-out voltage, typ.	36 V / 13 V AC 40 V / 14 V DC	64 V / 26 V AC 69 V / 22 V DC	112 V / 43 V AC 129 V / 36 V DC	65 V / 23 V AC	112 V / 45 V AC
Pull-in/drop-out current, typ.	5 mA / 2.5 mA AC 4 mA / 1.2 mA DC	2 mA / 1 mA AC 2 mA / 1 mA DC	2 mA / 1 mA AC 2 mA / 1 mA DC	3.5 mA / 1 mA AC	5 mA / 2 mA AC
Status indicator	Green LED	Green LED	Green LED	Green LED	Green LED
Protective circuit	Rectifier	Rectifier	Rectifier	Rectifier	Rectifier
<b>Output</b>					
Switch-on delay	< 11 ms	< 11 ms	< 14 ms	< 11 ms	< 14 ms
Switch-off delay	< 7 ms	< 7 ms	< 22 ms	< 7 ms	< 12 ms

<b>Ordering data</b>							
Screw connection	Type	TRS 60VUC 2CO	TRS 120VUC 2CO	TRS 230VUC 2CO	TRS 120VAC RC 2CO	TRS 230VAC RC 2CO	
Order No.		<b>1123520000</b>	<b>1123530000</b>	<b>1123540000</b>	<b>1123550000</b>	<b>1123570000</b>	
Tension clamp conn.	Type	TRZ 60VUC 2CO	TRZ 120VUC 2CO	TRZ 230VUC 2CO	TRZ 120VAC RC 2CO	TRZ 230VAC RC 2CO	
Order No.		<b>1123640000</b>	<b>1123650000</b>	<b>1123670000</b>	<b>1123680000</b>	<b>1123690000</b>	
<b>Note</b>							
	Spare relay	Type: RCL424060 Orderno.: 4058760000	Spare relay	Type: RCL424110 Orderno.: 4058590000	Spare relay	Type: RCL424110 Orderno.: 4058590000	
				Spare relay	Type: RCL424110 Orderno.: 4058590000	Spare relay	Type: RCL424110 Orderno.: 4058590000

**2 CO contact with hard gold-plated contacts**  
**AC/DC/UC coil**

- Space saving, just 12.8 mm modular width
- AgNi contact with gold plating
- Screw and tension clamp connection

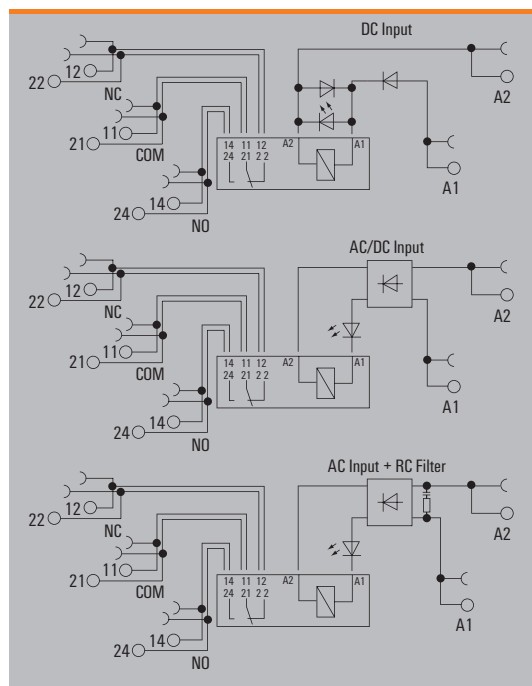
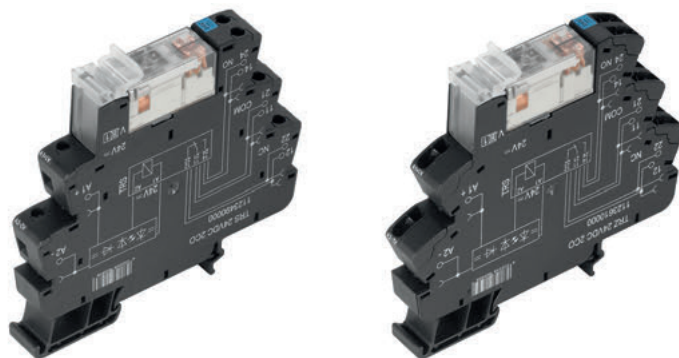

**Technical data**

<b>Output</b>			
Rated switching voltage / Continuous current	250 V AC / 8 A		
Max. switching voltage, AC	250 V		
Inrush current	15 A / 4 s		
Min. switching power	1 V / 1 mA		
DC / AC Switching capacity (resistive), max.	192 W @ 24 V / 2000 VA		
Contact material	AgNi 5µm Au		
Mechanical service life	30 x 10 <sup>6</sup> switching cycles		
Max. switching frequency at rated load	0.1 Hz		
<b>Rated data</b>			
Ambient temperature (operational)	-40 °C...60 °C		
Storage temperature	-40 °C...85 °C		
Humidity	5-95% rel. humidity, T <sub>v</sub> = 40°C, no condensation		
Approvals	CE, cULus, EAC, GL		
<b>Insulation coordination (EN 50178)</b>			
Rated voltage	300 V		
Impulse withstand voltage	6 kV (1.2/50 µs)		
Dielectric strength input - output	1.2 kV <sub>eff</sub> / 5 s		
Dielectric strength, contact / contact			
Dielectric strength to mounting rail	4 kV <sub>eff</sub> / 1 min.		
Creepage and clearance distance input - output	≥ 5.5 mm		
Overtoltage category	III		
Pollution degree	2		
<b>Dimensions</b>			
Clamping range (nominal / min. / max.)	mm <sup>2</sup>	<b>Screw connection</b>	<b>Tension clamp connection</b>
		1.5 / 0.14 / 2.5	1.5 / 0.14 / 2.5
Depth x width x height	mm	88 / 12.8 / 90	88 / 12.8 / 90
<b>Note</b>			
Accessories and dimensional drawings: refer to the TERMSERIES Accessories page.			

**Applications**

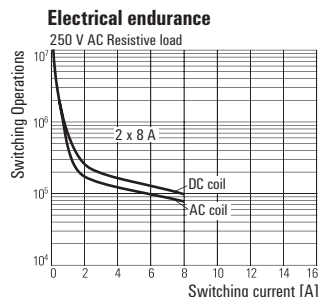
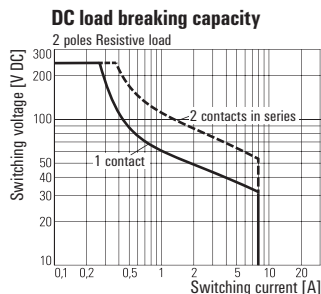



2 CO contact with hard gold-plated contacts  
AC/DC/UC coil

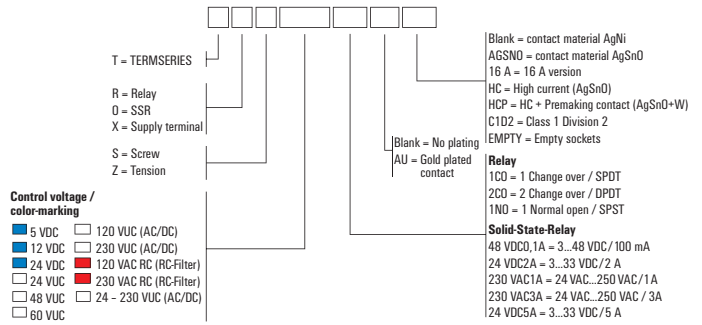

Ordering data

	5 V DC	12 V DC	24 V DC	24 V UC	48 V UC
<b>Input</b>					
Rated control voltage	5 V DC ±20 %	12 V DC ±20 %	24 V DC ±20 %	24 V UC ±10 %	48 V UC ±10 %
Rated current AC / DC	/ 80 mA	/ 33.3 mA	/ 20 mA	16 mA / 14 mA	9 mA / 7 mA
Power rating	400 mW	420 mW	480 mW	390 mVA / 350 mW	340 mW / 0.4 VA
Pull-in/drop-out voltage, typ.	3 V / 1.6 V DC	8 V / 3 V DC	18 V / 3.5 V DC	16 V / 9 V AC 18 V / 8 V DC	29 V / 11 V AC 33 V / 11 V DC
Pull-in/drop-out current, typ.	21.6 mA / 8 mA DC	21 mA / 5 mA DC	10 mA / 3 mA DC	11 mA / 4 mA AC 10 mA / 2 mA DC	6 mA / 3 mA AC 5 mA / 1.5 mA DC
Status indicator	Green LED	Green LED	Green LED	Green LED	Green LED
Protective circuit	Integrated free-wheel diode, Reverse polarity protection	Integrated free-wheel diode, Reverse polarity protection	Integrated free-wheel diode, Reverse polarity protection	Rectifier	Rectifier
<b>Output</b>					
Switch-on delay	< 11 ms	< 11 ms	< 11 ms	< 11 ms	< 11 ms
Switch-off delay	< 7 ms	< 8 ms	< 10 ms	< 7 ms	< 7 ms

<b>Ordering data</b>					
Screw connection	TR5 5VDC 2CO AU	TR5 12VDC 2CO AU	TR5 24VDC 2CO AU	TR5 24VUC 2CO AU	TR5 48VUC 2CO AU
Order No.	<b>1123710000</b>	<b>1123720000</b>	<b>1123730000</b>	<b>1123740000</b>	<b>1123750000</b>
Tension clamp conn.	TRZ 5VDC 2CO AU	TRZ 12VDC 2CO AU	TRZ 24VDC 2CO AU	TRZ 24VUC 2CO AU	TRZ 48VUC 2CO AU
Order No.	<b>1123830000</b>	<b>1123840000</b>	<b>1123850000</b>	<b>1123870000</b>	<b>1123880000</b>
<b>Note</b>					
	Spare relay Type: RCL4250005 Orderno.: 1174490000	Spare relay Type: RCL4250112 Orderno.: 4074580000	Spare relay Type: RCL4250224 Orderno.: 4058580000	Spare relay Type: RCL425024 Orderno.: 4058580000	Spare relay Type: RCL425048 Orderno.: 1201230000

Ordering data

	60 V UC	120 V UC	230 V UC	120 V AC RC	230 V AC RC
<b>Input</b>					
Rated control voltage	60 V UC ±10 %	120 V UC ±10 %	230 V UC ±5 %	120 V AC ±10 %	230 V AC ±5 %
Rated current AC / DC	8 mA / 6.1 mA	3.5 mA / 3.5 mA	4 mA / 4 mA	5.5 mA /	10 mA /
Power rating	480 mVA / 360 mW	420 mVA / 420 mW	920 mVA / 920 mW	0.73 VA	2.3 VA
Pull-in/drop-out voltage, typ.	36 V / 13 V AC 40 V / 14 V DC	64 V / 26 V AC 69 V / 22 V DC	112 V / 43 V AC 129 V / 36 V DC	65 V / 23 V AC	112 V / 45 V AC
Pull-in/drop-out current, typ.	5 mA / 2.5 mA AC 4 mA / 1.2 mA DC	2 mA / 1 mA AC 2 mA / 1 mA DC	2 mA / 1 mA AC 2 mA / 1 mA DC	3.5 mA / 1 mA AC	5 mA / 2 mA AC
Status indicator	Green LED	Green LED	Green LED	Green LED	Green LED
Protective circuit	Rectifier	Rectifier	Rectifier	Rectifier	Rectifier
<b>Output</b>					
Switch-on delay	< 11 ms	< 11 ms	< 14 ms	< 11 ms	< 14 ms
Switch-off delay	< 7 ms	< 7 ms	< 22 ms	< 7 ms	< 12 ms

<b>Ordering data</b>					
Screw connection	TR5 60VUC 2CO AU	TR5 120VUC 2CO AU	TR5 230VUC 2CO AU	TR5 120VAC RC 2CO AU	TR5 230VAC RC 2CO AU
Order No.	<b>1123770000</b>	<b>1123780000</b>	<b>1123790000</b>	<b>1123800000</b>	<b>1123810000</b>
Tension clamp conn.	TRZ 60VUC 2CO AU	TRZ 120VUC 2CO AU	TRZ 230VUC 2CO AU	TRZ 120VAC RC 2CO AU	TRZ 230VAC RC 2CO AU
Order No.	<b>1123890000</b>	<b>1123900000</b>	<b>1123910000</b>	<b>1123920000</b>	<b>1123930000</b>
<b>Note</b>					
	Spare relay Type: RCL425060 Orderno.: 1201260000	Spare relay Type: RCL425110 Orderno.: 8828370000	Spare relay Type: RCL425110 Orderno.: 8828370000	Spare relay Type: RCL425110 Orderno.: 8828370000	Spare relay Type: RCL425110 Orderno.: 8828370000

**2 CO contacts**  
**multi-voltage input**

- Space saving, just 12.8 mm modular width
- AgNi contact
- Screw and tension clamp connection
- Multi-voltage input: 24 to 230 V UC in one module

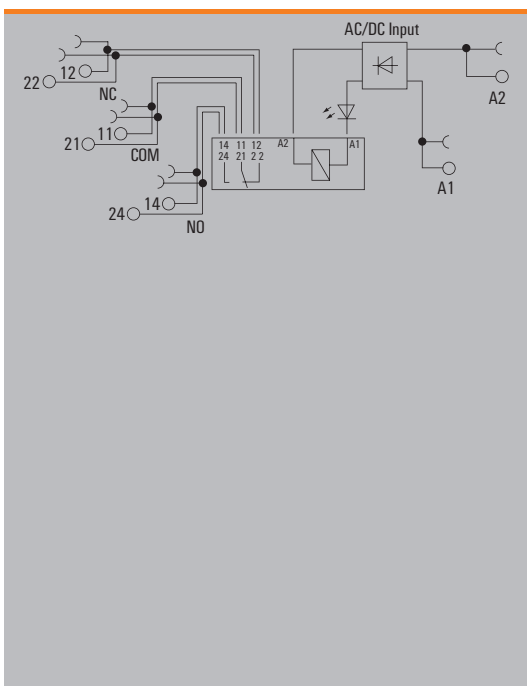
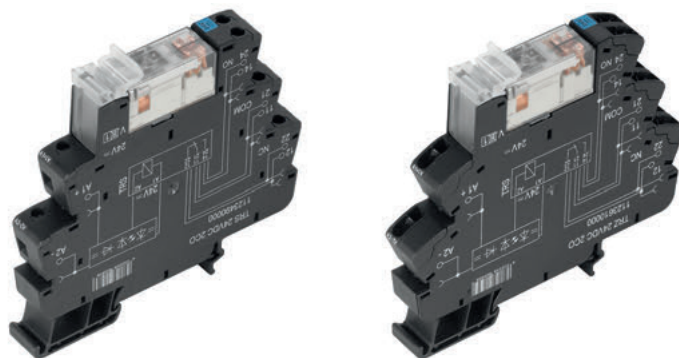

**Technical data**

<b>Output</b>			
Rated switching voltage / Continuous current	250 V AC / 8 A		
Max. switching voltage, AC	250 V		
Inrush current	15 A / 4 s		
Min. switching power	100 mA / 5 V, 10 V / 10 mA		
DC / AC Switching capacity (resistive), max.	192 W @ 24 V / 2000 VA		
Contact material	AgNi		
Mechanical service life	30 x 10 <sup>6</sup> switching cycles		
Max. switching frequency at rated load	0.1 Hz		
<b>Rated data</b>			
Ambient temperature (operational)	-40 °C...60 °C		
Storage temperature	-40 °C...85 °C		
Humidity	5-95% rel. humidity, T <sub>v</sub> = 40°C, no condensation		
Approvals	CE, cULus, EAC, GL		
<b>Insulation coordination (EN 50178)</b>			
Rated voltage	300 V		
Impulse withstand voltage	6 kV (1.2/50 µs)		
Dielectric strength input - output	1.2 kV <sub>eff</sub> / 5 s		
Dielectric strength, contact / contact			
Dielectric strength to mounting rail	4 kV <sub>eff</sub> / 1 min.		
Creepage and clearance distance input - output	≥ 5.5 mm		
Overtoltage category	III		
Pollution degree	2		
<b>Dimensions</b>			
Clamping range (nominal / min. / max.)	mm <sup>2</sup>	<b>Screw connection</b>	<b>Tension clamp connection</b>
		1.5 / 0.14 / 2.5	1.5 / 0.14 / 2.5
Depth x width x height	mm	88 / 12.8 / 90	88 / 12.8 / 90
<b>Note</b>			
Accessories and dimensional drawings: refer to the TERMSERIES Accessories page.			

**Ordering data**

<b>Input</b>	
Rated control voltage	24...230 V UC ±10 %
Rated current AC / DC	6 mA @ 230 V UC / 45 mA @ 24 VUC
Power rating	1.08 W @ 24 V UC, 1.38 W @ 230 V UC
Pull-in/drop-out voltage, typ.	16 V / 6 V AC 16 V / 5 V DC
Pull-in/drop-out current, typ.	
Status indicator	Green LED
Protective circuit	Rectifier
<b>Output</b>	
Switch-on delay	< 22 ms
Switch-off delay	< 125 ms

<b>Ordering data</b>	
Screw connection	Type TRS 24-230VUC 2CO
Order No.	<b>1123580000</b>
Tension clamp conn.	Type TRZ 24-230VUC 2CO
Order No.	<b>1123700000</b>
<b>Note</b>	
Spare relay Type: RCL424024 Orderno.: 4058570000	

**2 CO contact with hard gold-plated contacts  
multi-voltage input**

- Space saving, just 12.8 mm modular width
- AgNi contact with gold plating
- Screw and tension clamp connection
- Multi-voltage input: 24 to 230 V UC in one module

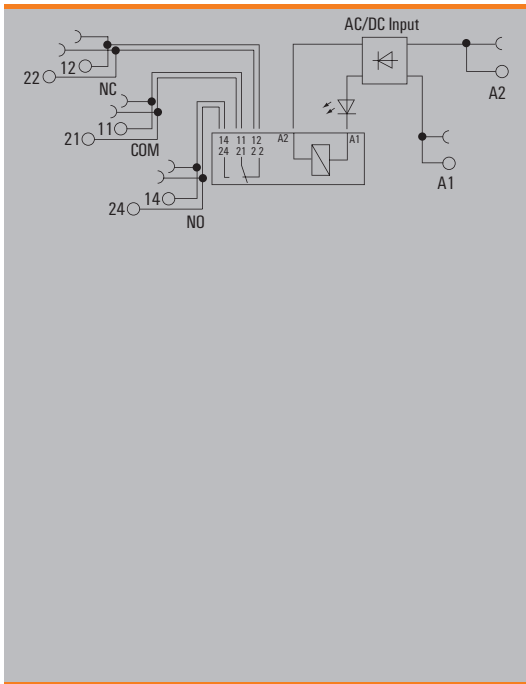
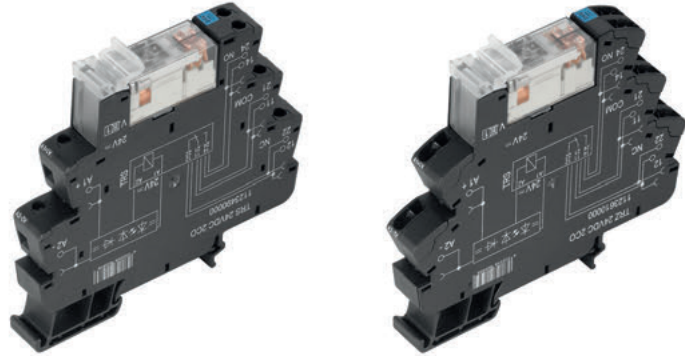

**Technical data**

<b>Output</b>			
Rated switching voltage / Continuous current	250 V AC / 8 A		
Max. switching voltage, AC	250 V		
Inrush current	15 A / 4 s		
Min. switching power	1 V / 1 mA		
DC / AC Switching capacity (resistive), max.	192 W @ 24 V / 2000 VA		
Contact material	AgNi 5µm Au		
Mechanical service life	30 x 10 <sup>6</sup> switching cycles		
Max. switching frequency at rated load	0.1 Hz		
<b>Rated data</b>			
Ambient temperature (operational)	-40 °C...60 °C		
Storage temperature	-40 °C...85 °C		
Humidity	5-95% rel. humidity, T <sub>v</sub> = 40°C, no condensation		
Approvals	CE, cULus, EAC, GL		
<b>Insulation coordination (EN 50178)</b>			
Rated voltage	300 V		
Impulse withstand voltage	6 kV (1.2/50 µs)		
Dielectric strength input - output	1.2 kV <sub>eff</sub> / 5 s		
Dielectric strength, contact / contact			
Dielectric strength to mounting rail	4 kV <sub>eff</sub> / 1 min.		
Creepage and clearance distance input - output	≥ 5.5 mm		
Overvoltage category	III		
Pollution degree	2		
<b>Dimensions</b>			
Clamping range (nominal / min. / max.)	mm <sup>2</sup>	<b>Screw connection</b>	<b>Tension clamp connection</b>
		1.5 / 0.14 / 2.5	1.5 / 0.14 / 2.5
Depth x width x height	mm	88 / 12.8 / 90	88 / 12.8 / 90
<b>Note</b>			
Accessories and dimensional drawings: refer to the TERMSERIES Accessories page.			

**Ordering data**

<b>Input</b>	
Rated control voltage	24...230 V UC ±10 %
Rated current AC / DC	6 mA @ 230 V UC / 45 mA @ 24 VUC
Power rating	1.08 W @ 24 V UC, 1.38 W @ 230 V UC
Pull-in/drop-out voltage, typ.	16 V / 6 V AC 16 V / 5 V DC
Pull-in/drop-out current, typ.	
Status indicator	Green LED
Protective circuit	Rectifier
<b>Output</b>	
Switch-on delay	< 22 ms
Switch-off delay	< 125 ms

<b>Ordering data</b>	
Screw connection	Type TRS 24-230VUC 2CO AU
Order No.	<b>1123820000</b>
Tension clamp conn.	Type TRZ 24-230VUC 2CO AU
Order No.	<b>1123940000</b>
<b>Note</b>	
Spare relay Type: RCL425024 Orderno.: 4058580000	

**Solid-state relay, 3...48 V DC / 100 mA**

**Output versions**

- Space saving, just 6.4 mm modular width
- 5 cross-connection levels
- Screw and tension clamp connection

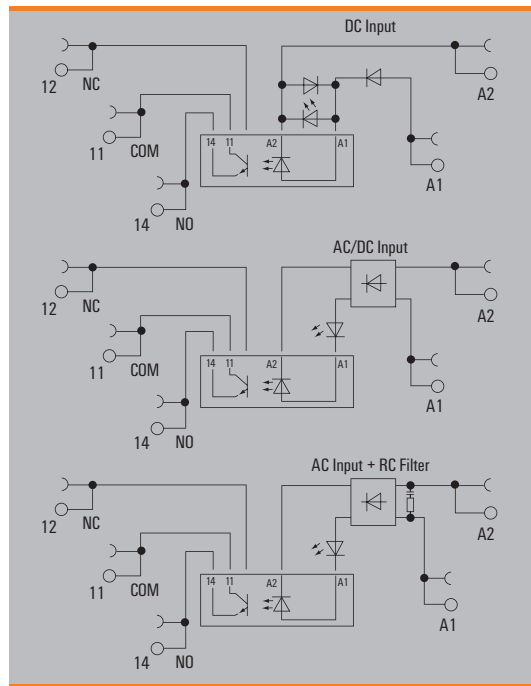
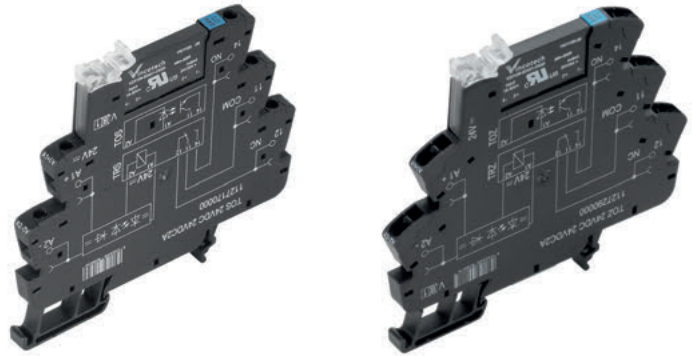

**Technical data**

Load side	
Rated switching voltage	3... 48 V DC
Continuous current	100 mA
Inrush current	
Solid-state type	Bipolar transistor
Voltage drop at max. load	≤ 1 V
Leakage current	< 10 µA
Protective circuit, load side	Integrated free-wheel diode
Short-circuit-proof / Protective circuit, load side	No / Integrated free-wheel diode
General data	
Ambient temperature (operational)	-20 °C...60 °C
Storage temperature	-40 °C...70 °C
Humidity	5-95% rel. humidity, T <sub>v</sub> = 40°C, no condensation
Approvals	CE; cULus; EAC; GL
Insulation coordination (EN 50178)	
Rated voltage	300 V
Impulse withstand voltage	6 kV (1.2/50 µs)
Dielectric strength for control side - load side	2.5 kV <sub>eff</sub>
Dielectric strength to mounting rail	4 kV <sub>eff</sub> / 1 min.
Clearance and creepage distances for control side - load side	≥ 5.5 mm
Overvoltage category	III
Pollution degree	2
Dimensions	
Clamping range (nominal / min. / max.)	mm <sup>2</sup> 1.5 / 0.14 / 2.5
Depth x width x height	mm 88 / 6.4 / 90
Note	
Accessories and dimensional drawings: refer to the TERMSERIES Accessories page.	

	Screw connection	Tension clamp conn.
Clamping range (nominal / min. / max.)	mm <sup>2</sup> 1.5 / 0.14 / 2.5	1.5 / 0.14 / 2.5
Depth x width x height	mm 88 / 6.4 / 90	88 / 6.4 / 90

Solid-state relay, 3...48 V DC / 100 mA

Output versions

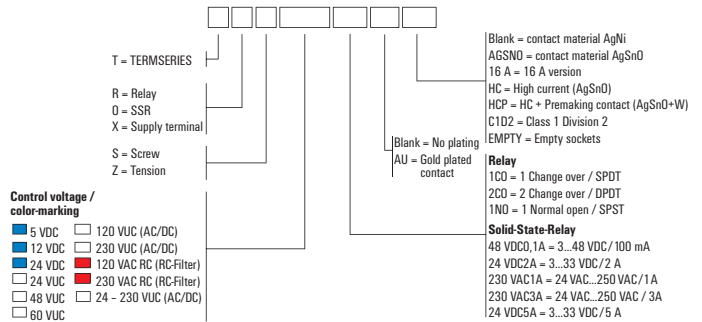

Ordering data

	5 V DC	12 V DC	24 V DC	24 V UC	48 V UC
<b>Control side</b>					
Rated control voltage	5 V DC ±20 %	12 V DC ±20 %	24 V DC ±20 %	24 V UC ±10 %	48 V UC ±10 %
Nominal control current	7 mA DC (±20 %)	9.6 mA DC (±20 %)	10 mA DC ±20 %	10 mA AC ±20 %, 6 mA DC (±20 %)	8 mA AC (±20 %), 7 mA DC (±20 %)
Power rating	35 mW	112 mW	240 mW	154 mW	290 mVA / 192 mW
Cut-in / dropout voltage	3.4 V / 1.5 V DC	4.7 V / 4.6 V DC	17 V / 10 V DC	18 V / 12 V AC, 14 V / 13 V DC	36 V / 19 V AC, 36 V / 19 V DC
Input frequency	10 Hz	10 Hz	300 Hz	DC: 100 Hz / AC: 3 Hz	DC: 100 Hz / AC: 3 Hz
Status indicator	Green LED	Green LED	Green LED	Green LED	Green LED
Protective circuit	Reverse polarity protection, Integrated free-wheel diode	Reverse polarity protection, Integrated free-wheel diode	Reverse polarity protection, Integrated free-wheel diode	Rectifier	Rectifier
<b>Load side</b>					
Switch-on delay	< 6.5 ms	< 6.5 ms	< 35 µs	< 55 µs	< 55 µs
Switch-off delay	< 10 ms	< 10 ms	< 355 µs	< 4 ms	< 4 ms

Ordering data					
Screw connection	Type	TOS 5VDC 48VDC0,1A	TOS 12VDC 48VDC0,1A	TOS 24VDC 48VDC0,1A	TOS 24VUC 48VDC0,1A
	Order No.	<b>1126920000</b>	<b>1126930000</b>	<b>1126940000</b>	<b>1126950000</b>
Tension clamp conn.	Type	TOZ 5VDC 48VDC0,1A	TOZ 12VDC 48VDC0,1A	TOZ 24VDC 48VDC0,1A	TOZ 24VUC 48VDC0,1A
	Order No.	<b>1127030000</b>	<b>1127040000</b>	<b>1127050000</b>	<b>1127060000</b>
<b>Note</b>		Spare solid-state relay Type: SSS 5 V/24 V 0.1 A DC Orderno.: 4064320000	Spare solid-state relay Type: SSS 5 V/24 V 0.1 A DC Orderno.: 4064320000	Spare solid-state relay Type: SSS 24 V/24 V 0.1 A DC Orderno.: 4061180000	Spare solid-state relay Type: SSS 24 V/24 V 0.1 A DC Orderno.: 4061180000

Ordering data

	60 V UC	120 V UC	230 V UC	120 V AC RC	230 V AC RC
<b>Control side</b>					
Rated control voltage	60 V UC ±10 %	120 V UC ±10 %	230 V UC ±10 %	120 V AC ±10 %	230 V AC ±10 %
Nominal control current	5 mA AC (±20 %), 3 mA DC (±20 %)	5 mA AC (±30 %), 3 mA DC (±30 %)	3.5 mA AC (±30 %), 3 mA DC (±30 %)	7 mA AC (±20 %)	9 mA AC
Power rating	< 300 mW	0.48 VA	0.8 VA / 660 mW	0.84 VA	2.1 VA
Cut-in / dropout voltage	37 V / 20 V AC, 35 V / 26 V DC	82 V / 65 V AC, 86 V / 74 V DC	159 V / 99 V AC, 145 V / 128 V DC	79 V / 60 V AC	129 V / 90 V AC
Input frequency	DC: 10 Hz / AC: 3 Hz	3 Hz	3 Hz	3 Hz	3 Hz
Status indicator	Green LED	Green LED	Green LED	Green LED	Green LED
Protective circuit	Rectifier	Rectifier	Rectifier	RC element	RC element
<b>Load side</b>					
Switch-on delay	< 6.5 ms	< 6.5 ms	< 7 ms	< 6.5 ms	< 7 ms
Switch-off delay	< 10 ms	< 10 ms	< 10 ms	< 10 ms	< 10 ms

Ordering data					
Screw connection	Type	TOS 60VUC 48VDC0,1A	TOS 120VUC 48VDC0,1A	TOS 230VUC 48VDC0,1A	TOS 120VAC RC 48VDC0,1A
	Order No.	<b>1126970000</b>	<b>1126980000</b>	<b>1126990000</b>	<b>1127000000</b>
Tension clamp conn.	Type	TOZ 60VUC 48VDC0,1A	TOZ 120VUC 48VDC0,1A	TOZ 230VUC 48VDC0,1A	TOZ 120VAC RC 48VDC0,1A
	Order No.	<b>1127080000</b>	<b>1127090000</b>	<b>1127100000</b>	<b>1127110000</b>
<b>Note</b>		Spare solid-state relay Type: SSS 60 V/24 V 0.1 A DC Orderno.: 4061230000	Spare solid-state relay Type: SSS 60 V/24 V 0.1 A DC Orderno.: 4061230000	Spare solid-state relay Type: SSS 60 V/24 V 0.1 A DC Orderno.: 4061230000	Spare solid-state relay Type: SSS 60 V/24 V 0.1 A DC Orderno.: 4061230000

**Solid-state relay, 3...48 V DC / 100 mA**

**Output versions, multi-voltage input**

- Space saving, just 6.4 mm modular width
- 5 cross-connection levels
- Screw and tension clamp connection
- Multi-voltage input: 24 to 230 V UC in one module

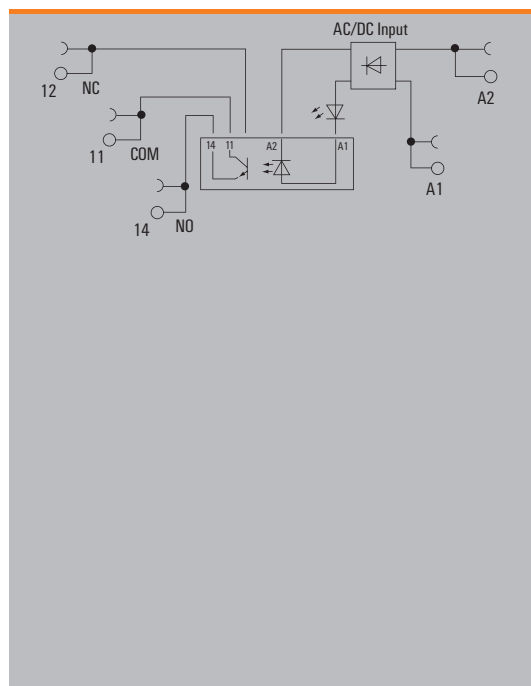
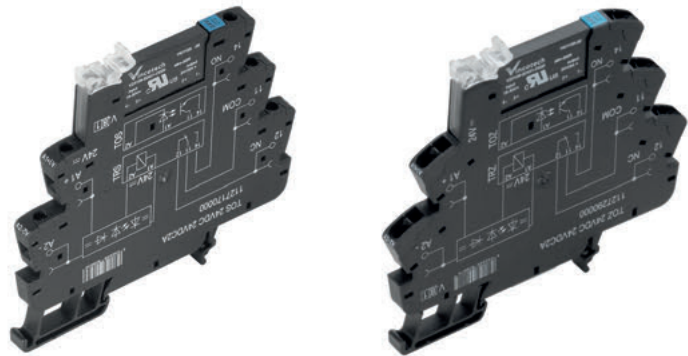

**Technical data**

Load side	
Rated switching voltage	3... 48 V DC
Continuous current	100 mA
Inrush current	
Solid-state type	Bipolar transistor
Voltage drop at max. load	≤ 1 V
Leakage current	< 10 µA
Protective circuit, load side	Integrated free-wheel diode
Short-circuit-proof / Protective circuit, load side	No / Integrated free-wheel diode
General data	
Ambient temperature (operational)	-20 °C...60 °C
Storage temperature	-40 °C...70 °C
Humidity	5-95% rel. humidity, T <sub>v</sub> = 40°C, no condensation
Approvals	CE, cULus, EAC, GL
Insulation coordination (EN 50178)	
Rated voltage	300 V
Impulse withstand voltage	6 kV (1.2/50 µs)
Dielectric strength for control side - load side	2.5 kV <sub>eff</sub>
Dielectric strength to mounting rail	4 kV <sub>eff</sub> / 1 min.
Clearance and creepage distances for control side - load side	≥ 5.5 mm
Overvoltage category	III
Pollution degree	2
Dimensions	
Clamping range (nominal / min. / max.)	mm <sup>2</sup> 1.5 / 0.14 / 2.5
Depth x width x height	mm 88 / 6.4 / 90
Note	
Accessories and dimensional drawings: refer to the TERMSERIES Accessories page.	

**Ordering data**

Control side	
Rated control voltage	24...230 V UC ±10 %
Nominal control current	22 mA @ 24 V DC, 4 mA @ 230 V AC
Power rating	530 mW @ 24 V DC, 930 mVA @ 230 V AC
Cut-in / dropout voltage	11.5 V / 6 V AC 11.5 V / 5 V DC
Input frequency	3 Hz
Status indicator	Green LED
Protective circuit	Rectifier
Load side	
Switch-on delay	< 20 ms
Switch-off delay	< 100 ms

Ordering data	
Screw connection	Type TOS 24-230VUC 48VDC0,1A
Order No.	1127020000
Tension clamp conn.	Type TOZ 24-230VUC 48VDC0,1A
Order No.	1127130000
Note	
Spare solid-state relay Type: SSS 24 V/24 V 0.1A DC Orderno.: 4061180000	



**Solid-state relay, 3...33 V DC / 2 A**

**Output versions**

- Space saving, just 6.4 mm modular width
- 5 cross-connection levels
- Screw and tension clamp connection

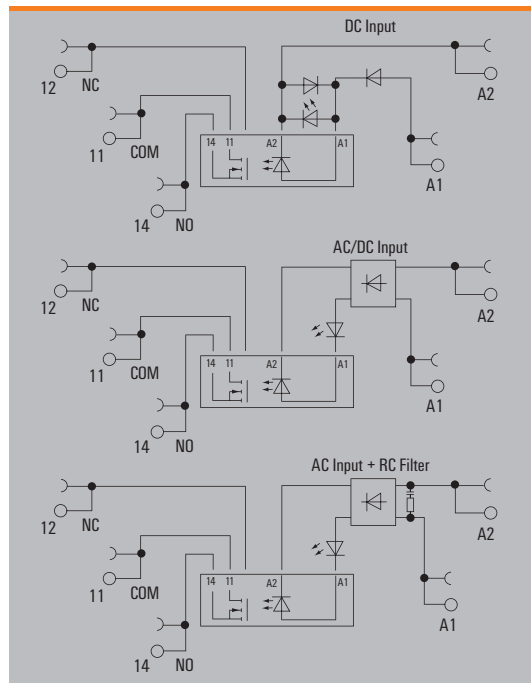
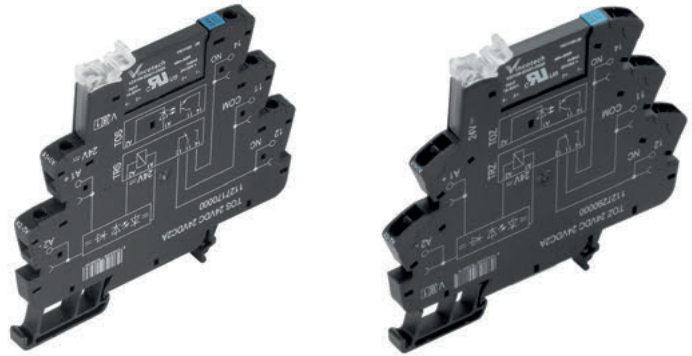

**Technical data**

Load side			
Rated switching voltage	3...33 V DC		
Continuous current	2 A		
Inrush current			
Solid-state type	MOS-FET		
Voltage drop at max. load	≤ 120 mV		
Leakage current	< 10 µA		
Protective circuit, load side	Integrated free-wheel diode		
Short-circuit-proof / Protective circuit, load side	No / Integrated free-wheel diode		
General data			
Ambient temperature (operational)	-20 °C...60 °C		
Storage temperature	-40 °C...70 °C		
Humidity	5-95% rel. humidity, T <sub>v</sub> = 40°C, no condensation		
Approvals	CE, cULus, EAC, GL		
Insulation coordination (EN 50178)			
Rated voltage	300 V		
Impulse withstand voltage	6 kV (1.2/50 µs)		
Dielectric strength for control side - load side	2.5 kV <sub>eff</sub>		
Dielectric strength to mounting rail	4 kV <sub>eff</sub> / 1 min.		
Clearance and creepage distances for control side - load side	≥ 5.5 mm		
Overvoltage category	III		
Pollution degree	2		
Dimensions			
Clamping range (nominal / min. / max.)	mm <sup>2</sup>	<b>Screw connection</b>	<b>Tension clamp conn.</b>
		1.5 / 0.14 / 2.5	1.5 / 0.14 / 2.5
Depth x width x height	mm	88 / 6.4 / 90	88 / 6.4 / 90
<b>Note</b>	Accessories and dimensional drawings: refer to the TERMSERIES Accessories page.		



Solid-state relay, 3...33 V DC / 2 A

Output versions

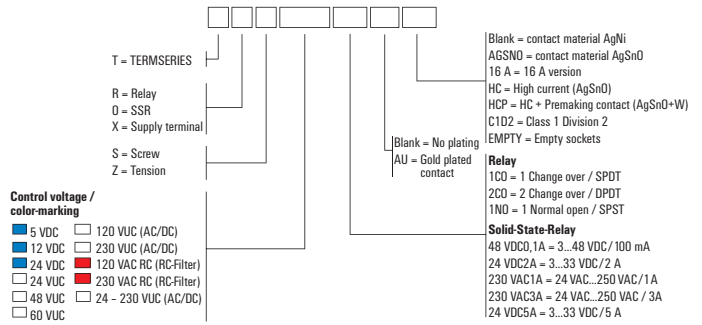

Ordering data	5 V DC	12 V DC	24 V DC	24 V UC	48 V UC
<b>Control side</b>					
Rated control voltage	5 V DC ±20 %	12 V DC ±20 %	24 V DC ±20 %	24 V UC ±10 %	48 V UC ±10 %
Nominal control current	10 mA DC ±20 %	9.6 mA DC (±20 %)	10 mA DC ±20 %	10 mA AC ±20 %, 6 mA DC (±20 %)	8 mA AC (±20 %), 7 mA DC (±20 %)
Power rating	50 mW	112 mW	240 mW	154 mW	290 mVA / 192 mW
Cut-in / dropout voltage	3.4 V / 1.5 V DC	4.7 V / 4.6 V DC	17 V / 10 V DC	18 V / 12 V AC 14 V / 13 V DC	36 V / 19 V AC 36 V / 19 V DC
Input frequency	300 Hz	300 Hz	300 Hz	DC: 10 Hz / AC: 3 Hz	DC: 10 Hz / AC: 3 Hz
Status indicator	Green LED	Green LED	Green LED	Green LED	Green LED
Protective circuit	Reverse polarity protection, Integrated free-wheel diode	Reverse polarity protection, Integrated free-wheel diode	Reverse polarity protection, Integrated free-wheel diode	Rectifier	Rectifier
<b>Load side</b>					
Switch-on delay	< 55 µs	< 55 µs	< 55 µs	< 6.5 ms	< 6.5 ms
Switch-off delay	< 1 ms	< 1.2 ms	< 1.2 ms	< 10 ms	< 10 ms

<b>Ordering data</b>					
Screw connection	Type: TOS 5VDC 24VDC2A	Type: TOS 12VDC 24VDC2A	Type: TOS 24VDC 24VDC2A	Type: TOS 24VUC 24VDC2A	Type: TOS 48VUC 24VDC2A
Order No.	1127140000	1127150000	1127170000	1127180000	1127190000
Tension clamp conn.	Type: TOZ 5VDC 24VDC2A	Type: TOZ 12VDC 24VDC2A	Type: TOZ 24VDC 24VDC2A	Type: TOZ 24VUC 24VDC2A	Type: TOZ 48VUC 24VDC2A
Order No.	1127270000	1127280000	1127290000	1127300000	1127310000
<b>Note</b>					
	Spare solid-state relay Type: SSS 5 V/24 V 2 A DC Orderno.: 4064310000	Spare solid-state relay Type: SSS 5 V/24 V 2 A DC Order no.: 4064310000	Spare solid-state relay Type: SSS 24 V/24 V 2 A DC Orderno.: 4061190000	Spare solid-state relay Type: SSS 24 V/24 V 2 A DC Orderno.: 4061190000	Spare solid-state relay Type: SSS 24 V/24 V 2 A DC Orderno.: 4061190000

Ordering data	60 V UC	120 V UC	230 V UC	120 V AC RC	230 V AC RC
<b>Control side</b>					
Rated control voltage	60 V UC ±10 %	120 V UC ±10 %	230 V UC ±10%	120 V AC ±10 %	230 V AC ±10 %
Nominal control current	5 mA AC (±20 %), 3 mA DC (±20 %)	5 mA AC (±30 %), 3 mA DC (±30 %)	3.5 mA AC (±30 %), 3 mA DC (±30 %)	7 mA AC (±20 %)	9 mA AC
Power rating	< 300 mW	0.48 VA	0.8 VA / 660 mW	0.84 VA	2.1 VA
Cut-in / dropout voltage	37 V / 20 V AC 35 V / 26 V DC	82 V / 65 V AC 86 V / 74 V DC	159 V / 99 V AC 145 V / 128 V DC	79 V / 60 V AC	129 V / 90 V AC
Input frequency	DC: 10 Hz / AC: 3 Hz	3 Hz	3 Hz	3 Hz	3 Hz
Status indicator	Green LED	Green LED	Green LED	Green LED	Green LED
Protective circuit	Rectifier	Rectifier	Rectifier	RC element	RC element
<b>Load side</b>					
Switch-on delay	< 6.5 ms	< 6.5 ms	< 7 ms	< 6.5 ms	< 7 ms
Switch-off delay	< 10 ms	< 10 ms	< 10 ms	< 10 ms	< 10 ms

<b>Ordering data</b>					
Screw connection	Type: TOS 60VUC 24VDC2A	Type: TOS 120VUC 24VDC2A	Type: TOS 230VUC 24VDC2A	Type: TOS 120VAC RC 24VDC2A	Type: TOS 230VAC RC 24VDC2A
Order No.	1127200000	1127210000	1127220000	1127230000	1127240000
Tension clamp conn.	Type: TOZ 60VUC 24VDC2A	Type: TOZ 120VUC 24VDC2A	Type: TOZ 230VUC 24VDC2A	Type: TOZ 120VAC RC 24VDC2A	Type: TOZ 230VAC RC 24VDC2A
Order No.	1127320000	1127330000	1127340000	1127350000	1127370000
<b>Note</b>					
	Spare solid-state relay Type: SSS 60 V/24 V 2 A DC Orderno.: 4061200000	Spare solid-state relay Type: SSS 60 V/24 V 2 A DC Orderno.: 4061200000	Spare solid-state relay Type: SSS 60 V/24 V 2 A DC Orderno.: 4061200000	Spare solid-state relay Type: SSS 60 V/24 V 2 A DC Orderno.: 4061200000	Spare solid-state relay Type: SSS 60 V/24 V 2 A DC Orderno.: 4061200000

**Solid-state relay, 3...33 V DC / 2 A**

**Output versions, multi-voltage input**

- Space saving, just 6.4 mm modular width
- 5 cross-connection levels
- Screw and tension clamp connection
- Multi-voltage input: 24 to 230 V UC in one module

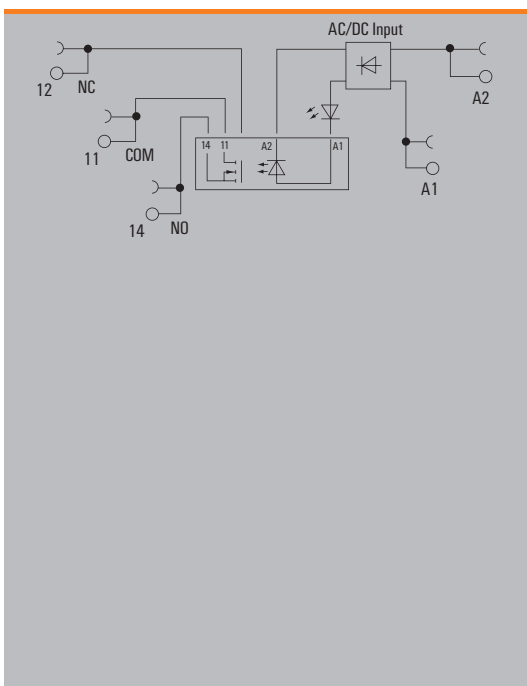
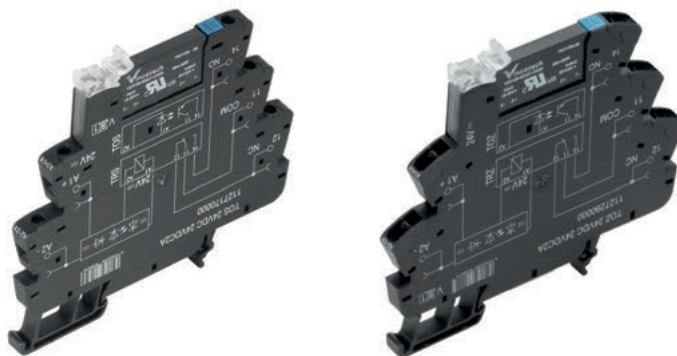

**Technical data**

Load side	
Rated switching voltage	3...33 V DC
Continuous current	2 A
Inrush current	
Solid-state type	MOS-FET
Voltage drop at max. load	≤ 120 mV
Leakage current	< 10 µA
Protective circuit, load side	Integrated free-wheel diode
Short-circuit-proof / Protective circuit, load side	No / Integrated free-wheel diode
General data	
Ambient temperature (operational)	-20 °C...60 °C
Storage temperature	-40 °C...70 °C
Humidity	5-95% rel. humidity, T <sub>v</sub> = 40°C, no condensation
Approvals	CE, cULus, EAC, GL
Insulation coordination (EN 50178)	
Rated voltage	300 V
Impulse withstand voltage	6 kV (1.2/50 µs)
Dielectric strength for control side - load side	2.5 kV <sub>eff</sub>
Dielectric strength to mounting rail	4 kV <sub>eff</sub> / 1 min.
Clearance and creepage distances for control side - load side	≥ 5.5 mm
Overvoltage category	III
Pollution degree	2
Dimensions	
Clamping range (nominal / min. / max.)	mm <sup>2</sup> 1.5 / 0.14 / 2.5
Depth x width x height	mm 88 / 6.4 / 90
Note	
Accessories and dimensional drawings: refer to the TERMSERIES Accessories page.	

**Ordering data**

Control side	
Rated control voltage	24...230 V UC ±10 %
Nominal control current	22 mA @ 24 V DC, 4 mA @ 230 V AC
Power rating	530 mW @ 24 V DC, 930 mVA @ 230 V AC
Cut-in / dropout voltage	11.5 V / 6 V AC 11.5 V / 5 V DC
Input frequency	3 Hz
Status indicator	Green LED
Protective circuit	Rectifier
Load side	
Switch-on delay	< 20 ms
Switch-off delay	< 100 ms

Ordering data	
Screw connection	Type TOS 24-230VUC 24VDC2A
Order No.	1127250000
Tension clamp conn.	Type TOZ 24-230VUC 24VDC2A
Order No.	1127380000
Note	
Spare solid-state relay Type: SSS 24 V/24 V 2 A DC Orderno.: 4061190000	

**Solid-state relay, 3...33 V DC / 2 A actuator versions**

- Space-saving, only 6.4 mm wide
  - AgNi contact
  - Screw and tension clamp connection
  - 24 V DC actuator version:
- Bridgeable, potential-free connection in the output (CC)

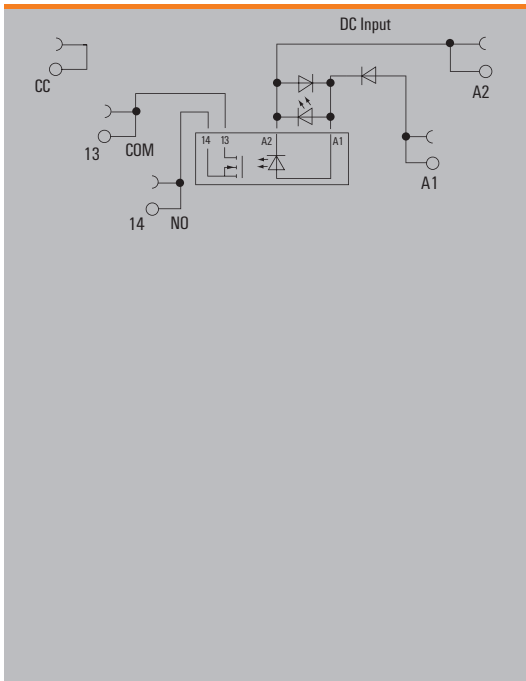
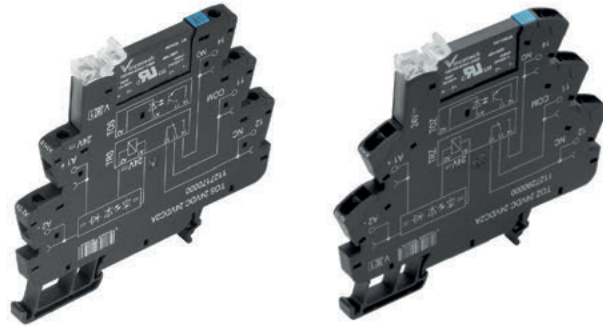

**Technical data**

Load side	
Rated switching voltage	3...33 V DC
Continuous current	2 A
Inrush current	
Solid-state type	MOS-FET
Voltage drop at max. load	≤ 120 mV
Leakage current	< 10 µA
Protective circuit, load side	Integrated free-wheel diode
Short-circuit-proof / Protective circuit, load side	No / Integrated free-wheel diode
General data	
Ambient temperature (operational)	-20 °C...60 °C
Storage temperature	-40 °C...70 °C
Humidity	5-95% rel. humidity, T <sub>v</sub> = 40°C, no condensation
Approvals	CE, EAC
Insulation coordination (EN 50178)	
Rated voltage	300 V
Impulse withstand voltage	6 kV (1.2/50 µs)
Dielectric strength for control side - load side	2.5 kV <sub>eff</sub>
Dielectric strength to mounting rail	4 kV <sub>eff</sub> / 1 min.
Clearance and creepage distances for control side - load side	≥ 5.5 mm
Overvoltage category	III
Pollution degree	2
Dimensions	
Clamping range (nominal / min. / max.)	mm <sup>2</sup> 1.5 / 0.14 / 2.5
Depth x width x height	mm 88 / 6.4 / 90
	mm 88 / 6.4 / 90
Note	
Accessories and dimensional drawings: refer to the TERMSERIES Accessories page.	

**Ordering data**

Control side	
Rated control voltage	24 V DC ±20 %
Nominal control current	10 mA DC ±20 %
Power rating	240 mW
Cut-in / dropout voltage	17 V / 10 V DC
Input frequency	300 Hz
Status indicator	Green LED
Protective circuit	Reverse polarity protection, Integrated free-wheel diode
Load side	
Switch-on delay	< 55 µs
Switch-off delay	< 1.2 ms

Ordering data	
Screw connection	Type TOS 24VDC ACT
Order No.	1391680000
Tension clamp conn.	Type TOZ 24VDC ACT
Order No.	1391690000
Note	

**Solid-state relay, 24...230 V AC / 1 A**

**Output versions**

- Space saving, just 6.4 mm modular width
- 5 cross-connection levels
- Screw and tension clamp connection

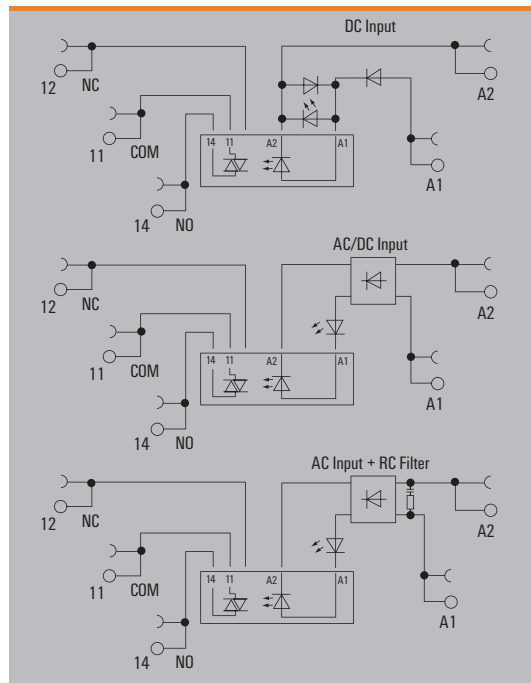
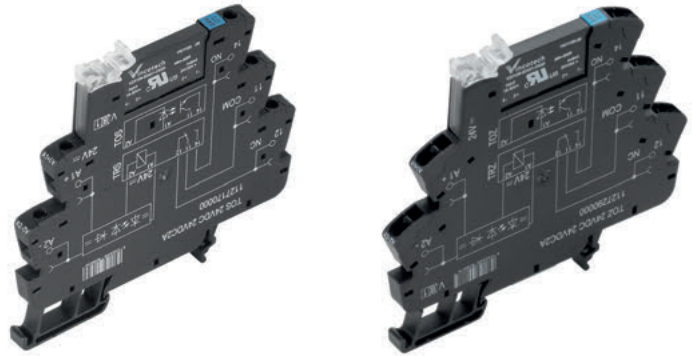

**Technical data**

Load side	
Rated switching voltage	24...240 V AC
Continuous current	1 A
Inrush current	
Solid-state type	Triac (zero-cross switch)
Voltage drop at max. load	≤ 1.6 V
Leakage current	< 10 µA
Protective circuit, load side	No
Short-circuit-proof / Protective circuit, load side	No / No
General data	
Ambient temperature (operational)	-20 °C...60 °C
Storage temperature	-40 °C...70 °C
Humidity	5-95% rel. humidity, T <sub>v</sub> = 40°C, no condensation
Approvals	CE, cULus, EAC, GL
Insulation coordination (EN 50178)	
Rated voltage	300 V
Impulse withstand voltage	6 kV (1.2/50 µs)
Dielectric strength for control side - load side	2.5 kV <sub>eff</sub>
Dielectric strength to mounting rail	4 kV <sub>eff</sub> / 1 min.
Clearance and creepage distances for control side - load side	≥ 5.5 mm
Overvoltage category	III
Pollution degree	2
Dimensions	
Clamping range (nominal / min. / max.)	mm <sup>2</sup> 1.5 / 0.14 / 2.5
Depth x width x height	mm 88 / 6.4 / 90
Note	
Accessories and dimensional drawings: refer to the TERMSERIES Accessories page.	

	Screw connection	Tension clamp conn.
Clamping range (nominal / min. / max.)	mm <sup>2</sup> 1.5 / 0.14 / 2.5	1.5 / 0.14 / 2.5
Depth x width x height	mm 88 / 6.4 / 90	88 / 6.4 / 90

Solid-state relay, 24...230 V AC / 1 A

Output versions

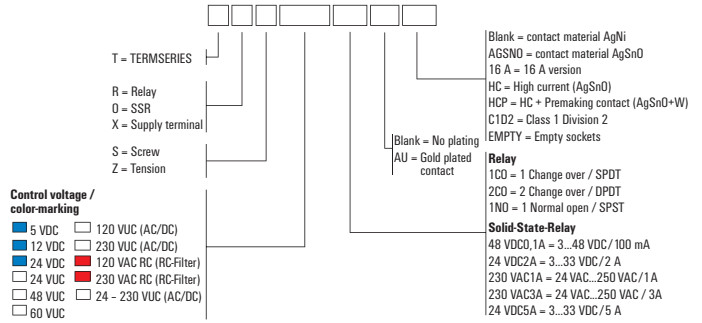

Ordering data	5 V DC	12 V DC	24 V DC	24 V UC	48 V UC
<b>Control side</b>					
Rated control voltage	5 V DC ±20 %	12 V DC ±20 %	24 V DC ±20 %	24 V UC ±10 %	48 V UC ±10 %
Nominal control current	15 mA DC (±20 %)	9.6 mA DC (±20 %)	10 mA DC ±20 %	10 mA AC ±20 %, 6 mA DC (±20 %)	6 mA AC (±20 %), 4 mA DC (±20 %)
Power rating	75 mW	112 mW	< 280 mW	154 mW	290 mVA / 192 mW
Cut-in / dropout voltage	3.4 V / 1.5 V DC	4.7 V / 4.6 V DC	17 V / 10 V DC	18 V / 12 V AC 14 V / 13 V DC	36 V / 19 V AC 36 V / 19 V DC
Input frequency	3 Hz	3 Hz	3 Hz	3 Hz	3 Hz
Status indicator	Green LED	Green LED	Green LED	Green LED	Green LED
Protective circuit	Reverse polarity protection, Integrated free-wheel diode	Reverse polarity protection, Integrated free-wheel diode	Reverse polarity protection, Integrated free-wheel diode	Rectifier	Rectifier
<b>Load side</b>					
Switch-on delay	< 12 ms	< 12 ms	< 12 ms	< 11 ms	< 11 ms
Switch-off delay	< 12 ms	< 12 ms	< 12 ms	< 11 ms	< 11 ms

Ordering data	5 V DC	12 V DC	24 V DC	24 V UC	48 V UC
Screw connection Type	TOS 5VDC 230VAC1A	TOS 12VDC 230VAC1A	TOS 24VDC 230VAC1A	TOS 24VUC 230VAC1A	TOS 48VUC 230VAC1A
Order No.	<b>1127390000</b>	<b>1127400000</b>	<b>1127410000</b>	<b>1127420000</b>	<b>1127430000</b>
Tension clamp conn. Type	TOZ 5VDC 230VAC1A	TOZ 12VDC 230VAC1A	TOZ 24VDC 230VAC1A	TOZ 24VUC 230VAC1A	TOZ 48VUC 230VAC1A
Order No.	<b>1127510000</b>	<b>1127520000</b>	<b>1127530000</b>	<b>1127540000</b>	<b>1127550000</b>
<b>Note</b>	Spare solid-state relay Type: SSS 5 V/230 V 1 A AC Orderno.: 1132260000	Spare solid-state relay Type: SSS 5 V/230 V 1 A AC Orderno.: 1132260000	Spare solid-state relay Type: SSS 24 V/230 V 1 A AC Orderno.: 4061210000	Spare solid-state relay Type: SSS 24 V/230 V 1 A AC Orderno.: 4061210000	Spare solid-state relay Type: SSS 24 V/230 V 1 A AC Orderno.: 4061210000

Ordering data	60 V UC	120 V UC	230 V UC	120 V AC RC	230 V AC RC
<b>Control side</b>					
Rated control voltage	60 V UC ±10 %	120 V UC ±10 %	230 V UC +5 % / -10 %	120 V AC ±10 %	230 V AC +5 % / -10 %
Nominal control current	5 mA AC (±20 %), 3 mA DC (±20 %)	5 mA AC (±30 %), 3 mA DC (±30 %)	3.5 mA AC (±30 %), 3 mA DC (±30 %)	7 mA AC (±20 %)	9 mA AC
Power rating	< 300 mW	0.48 VA	0.8 VA / 660 mW	0.84 VA	2.1 VA
Cut-in / dropout voltage	35 V / 20 V AC 35 V / 26 V DC	82 V / 65 V AC 86 V / 74 V DC	159 V / 99 V AC 145 V / 128 V DC	79 V / 60 V AC	142 V / 90 V AC
Input frequency	3 Hz	3 Hz	3 Hz	3 Hz	3 Hz
Status indicator	Green LED	Green LED	Green LED	Green LED	Green LED
Protective circuit	Rectifier	Rectifier	Rectifier	RC element	RC element
<b>Load side</b>					
Switch-on delay	< 11 ms	< 11 ms	< 20 ms	< 11 ms	< 20 ms
Switch-off delay	< 11 ms	< 11 ms	< 20 ms	< 11 ms	< 20 ms

Ordering data	60 V UC	120 V UC	230 V UC	120 V AC RC	230 V AC RC
Screw connection Type	TOS 60VUC 230VAC1A	TOS 120VUC 230VAC1A	TOS 230VUC 230VAC1A	TOS 120VAC RC 230VAC1A	TOS 230VAC RC 230VAC1A
Order No.	<b>1127440000</b>	<b>1127450000</b>	<b>1127470000</b>	<b>1127480000</b>	<b>1127490000</b>
Tension clamp conn. Type	TOZ 60VUC 230VAC1A	TOZ 120VUC 230VAC1A	TOZ 230VUC 230VAC1A	TOZ 120VAC RC 230VAC1A	TOZ 230VAC RC 230VAC1A
Order No.	<b>1127570000</b>	<b>1127580000</b>	<b>1127590000</b>	<b>1127600000</b>	<b>1127610000</b>
<b>Note</b>	Spare solid-state relay Type: SSS 60 V/230 V 1 A AC Orderno.: 4061220000	Spare solid-state relay Type: SSS 60 V/230 V 1 A AC Orderno.: 4061220000	Spare solid-state relay Type: SSS 60 V/230 V 1 A AC Orderno.: 4061220000	Spare solid-state relay Type: SSS 60 V/230 V 1 A AC Orderno.: 4061220000	Spare solid-state relay Type: SSS 60 V/230 V 1 A AC Orderno.: 4061220000

**Solid-state relay, 24...230 V AC / 1 A output versions, multi-voltage input**

- Space saving, just 6.4 mm modular width
- 5 cross-connection levels
- Screw and tension clamp connection
- Multi-voltage input: 24 to 230 V UC in one module

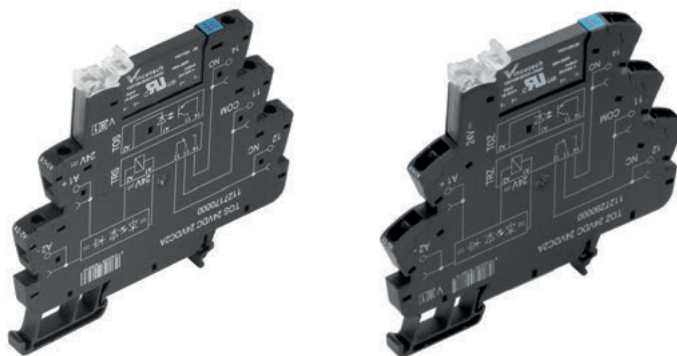

Relay modules and solid-state relays  
6 mm width

A

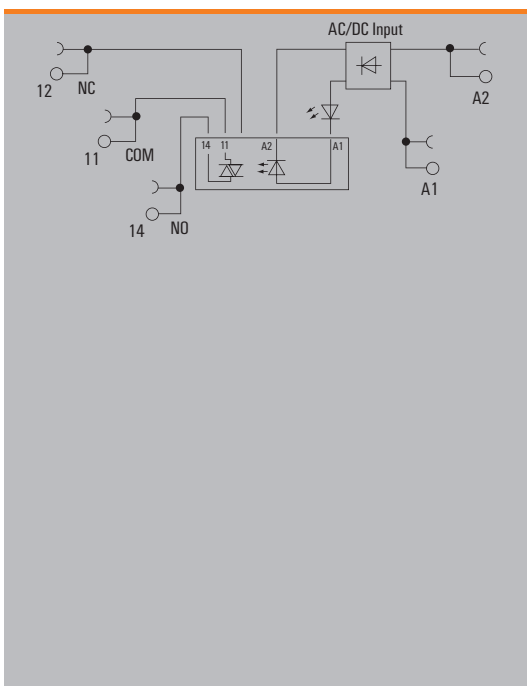

**Technical data**

Load side					
Rated switching voltage	24...240 V AC				
Continuous current	1 A				
Inrush current					
Solid-state type	Triac (zero-cross switch)				
Voltage drop at max. load	≤ 1 V				
Leakage current	< 10 µA				
Protective circuit, load side	No				
Short-circuit-proof / Protective circuit, load side	No / No				
General data					
Ambient temperature (operational)	-20 °C...60 °C				
Storage temperature	-40 °C...70 °C				
Humidity	5-95% rel. humidity, T <sub>v</sub> = 40°C, no condensation				
Approvals	CE, cULus, EAC, GL				
Insulation coordination (EN 50178)					
Rated voltage	300 V				
Impulse withstand voltage	6 kV (1.2/50 µs)				
Dielectric strength for control side - load side	2.5 kV <sub>eff</sub>				
Dielectric strength to mounting rail	4 kV <sub>eff</sub> / 1 min.				
Clearance and creepage distances for control side - load side	≥ 5.5 mm				
Overvoltage category	III				
Pollution degree	2				
Dimensions		Screw connection		Tension clamp conn.	
Clamping range (nominal / min. / max.)		mm <sup>2</sup> 1.5 / 0.14 / 2.5		1.5 / 0.14 / 2.5	
Depth x width x height		mm 88 / 6.4 / 90		88 / 6.4 / 90	
Note		Accessories and dimensional drawings: refer to the TERMSERIES Accessories page.			

**Ordering data**

Control side	
Rated control voltage	24...230 V UC ±10 %
Nominal control current	22 mA @ 24 V DC, 4 mA @ 230 V AC
Power rating	530 mW @ 24 V DC, 930 mVA @ 230 V AC
Cut-in / dropout voltage	11.5 V / 6 V AC 11.5 V / 5 V DC
Input frequency	3 Hz
Status indicator	Green LED
Protective circuit	Rectifier

**24 V - 230 V UC**

Load side	
Switch-on delay	< 20 ms
Switch-off delay	< 100 ms

Ordering data	
Screw connection	Type TOS 24-230VUC 230VAC1A
Order No.	<b>1127500000</b>
Tension clamp conn.	Type TOZ 24-230VUC 230VAC1A
Order No.	<b>1127620000</b>

Note	
Spare solid-state relay Type: SSS 24 V/230 V 1 A AC Orderno.: 4061210000	



**Solid-state relay, 0...33 V DC / 3.5 A**

**Output versions**

- Space saving, just 12.8 mm modular width
- 5 cross-connection levels
- Screw and tension clamp connection

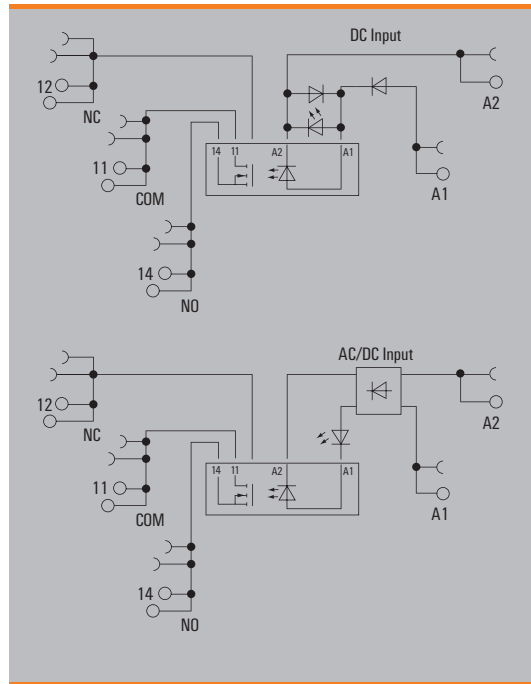
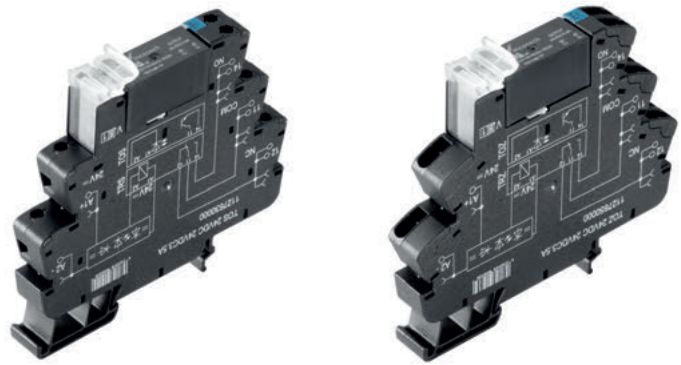

**Technical data**

Load side	
Rated switching voltage	3...33 V DC
Continuous current	3.5 A
Inrush current	
Solid-state type	MOS-FET
Voltage drop at max. load	≤ 0.3 V
Leakage current	< 10 µA
Protective circuit, load side	Integrated free-wheel diode
Short-circuit-proof / Protective circuit, load side	No / Integrated free-wheel diode
General data	
Ambient temperature (operational)	-20 °C...60 °C
Storage temperature	-40 °C...85 °C
Humidity	5-95% rel. humidity, T <sub>v</sub> = 40°C, no condensation
Approvals	CE, cULus, EAC, GL
Insulation coordination (EN 50178)	
Rated voltage	300 V
Impulse withstand voltage	6 kV (1.2/50 µs)
Dielectric strength for control side - load side	2.5 kV <sub>eff</sub>
Dielectric strength to mounting rail	4 kV <sub>eff</sub> / 1 min.
Clearance and creepage distances for control side - load side	≥ 5.5 mm
Overvoltage category	III
Pollution degree	2
Dimensions	
Clamping range (nominal / min. / max.)	mm <sup>2</sup> 1.5 / 0.14 / 2.5
Depth x width x height	mm 88 / 12.8 / 90
Screw connection	
	mm 1.5 / 0.14 / 2.5
	mm 88 / 12.8 / 90
Note	
Accessories and dimensional drawings: refer to the TERMSERIES Accessories page.	

**Ordering data**

	24 V DC	24 V - 230 V UC
<b>Control side</b>		
Rated control voltage	24 V DC ±20 %	24...230 V UC ±10 %
Nominal control current	10 mA DC ±20 %	28 mA @ 24 V UC, 4 mA @ 230 V UC
Power rating	240 mW	672 mW @ 24 V UC, 920 mW @ 230 V UC
Cut-in / dropout voltage	15 V / 5 V DC	12 V / 6 V AC 12 V / 5 V DC
Input frequency	300 Hz	3 Hz
Status indicator	Green LED	Green LED
Protective circuit	Reverse polarity protection, Integrated free-wheel diode	Rectifier
<b>Load side</b>		
Switch-on delay	< 55 µs	≤ 10 ms
Switch-off delay	< 600 µs	< 100 ms

Ordering data		24 V DC	24 V - 230 V UC
Screw connection	Type	TOS 24VDC 24VDC3,5A	TOS 24-230VUC 24VDC3,5A
	Order No.	<b>1127630000</b>	<b>1127640000</b>
Tension clamp conn.	Type	TOZ 24VDC 24VDC3,5A	TOZ 24-230VUC 24VDC3,5A
	Order No.	<b>1127650000</b>	<b>1127670000</b>
<b>Note</b>		Spare solid-state relay Type: SSR 10-32 V DC/0-35 V DC 5 A Orderno.: 1132310000	Spare solid-state relay Type: SSR 10-32 V DC/0-35 V DC 5 A Orderno.: 1132310000



**Solid-state relay, 0...33 VDC / 5 A**

**Output versions**

- Space-saving, 12.8 mm wide
- 5 A DC output current
- Internal cross-connection of the output terminals
- Screw and tension clamp connection
- Multi-voltage input: 24...230 V UC in one module

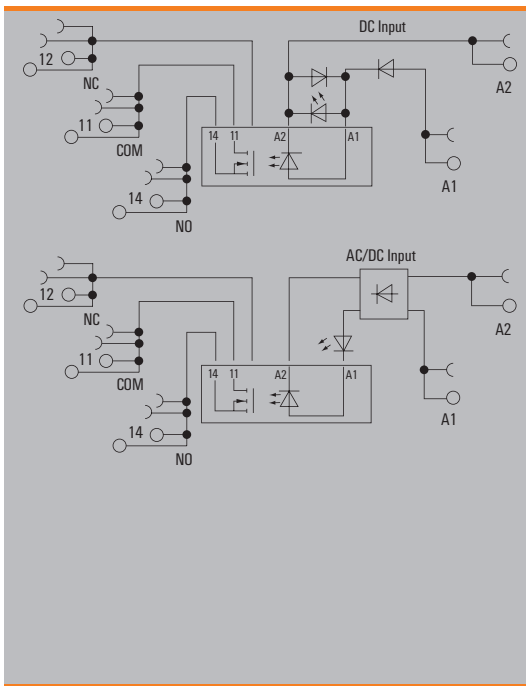
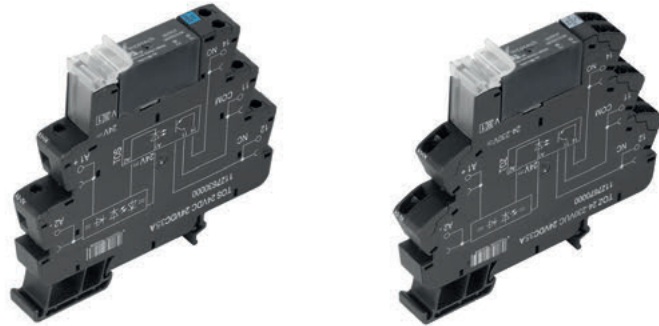

**Technical data**

Load side	
Rated switching voltage	3...33 V DC
Continuous current	5 A
Inrush current	
Solid-state type	MOS-FET
Voltage drop at max. load	≤ 0.3 V
Leakage current	< 10 µA
Protective circuit, load side	Integrated free-wheel diode
Short-circuit-proof / Protective circuit, load side	/ Integrated free-wheel diode
General data	
Ambient temperature (operational)	-20 °C...60 °C
Storage temperature	-40 °C...70 °C
Humidity	5-95% rel. humidity, T <sub>v</sub> = 40°C, no condensation
Approvals	CE
Insulation coordination (EN 50178)	
Rated voltage	300 V
Impulse withstand voltage	6 kV (1.2/50 µs)
Dielectric strength for control side - load side	2.5 kV <sub>eff</sub>
Dielectric strength to mounting rail	4 kV <sub>eff</sub> / 1 min.
Clearance and creepage distances for control side - load side	≥ 5.5 mm
Overvoltage category	III
Pollution degree	2
Dimensions	
Clamping range (nominal / min. / max.)	/ 0.14 / 2.5 / 0.14 / 2.5
Depth x width x height	mm 88 / 12.8 / 90 88 / 12.8 / 90
Note	

**Ordering data**

	24 V DC	24 V - 230 V UC
<b>Control side</b>		
Rated control voltage	24 V DC ±20 %	24...230 V UC ±10 %
Nominal control current	10 mA DC ±20 %	28 mA @ 24 V UC, 4 mA @ 230 V UC
Power rating	240 mW	672 mW @ 24 V UC, 920 mW @ 230 V UC
Cut-in / dropout voltage	15 V / 5 V DC	12 V / 6 V AC 12 V / 5 V DC
Input frequency	300 Hz	3 Hz
Status indicator	Green LED	Green LED
Protective circuit	Reverse polarity protection, Integrated free-wheel diode	Rectifier
<b>Load side</b>		
Switch-on delay	< 55 µs	≤ 10 ms
Switch-off delay	< 600 µs	< 100 ms

Ordering data			
Screw connection	Type	TOS 24VDC 24VDC5A	TOS 24-230VUC 24VDC5A
	Order No.	<b>1990960000</b>	<b>1990970000</b>
Tension clamp conn.	Type	TOZ 24VDC 24VDC5A	TOZ 24-230VUC 24VDC5A
	Order No.	<b>1990980000</b>	<b>1990990000</b>
<b>Note</b>			

**Solid-state relay, 12...275 V AC / 1 A**

**Output versions**

- Space saving, just 12.8 mm modular width
- 5 cross-connection levels
- Screw and tension clamp connection

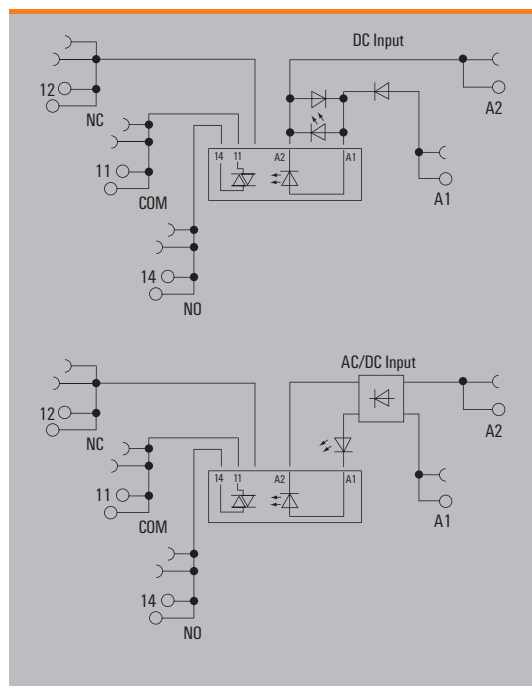
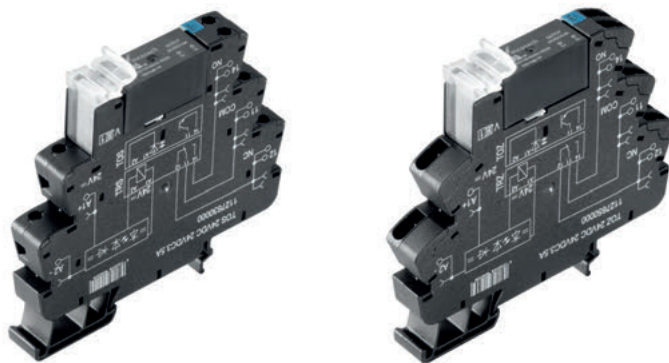

**Technical data**

<b>Load side</b>	
Rated switching voltage	12...275 V AC
Continuous current	1 A
Inrush current	
Solid-state type	Triac (zero-cross switch)
Voltage drop at max. load	≤ 1.1 V
Leakage current	< 10 µA
Protective circuit, load side	No
Short-circuit-proof / Protective circuit, load side	No / No
<b>General data</b>	
Ambient temperature (operational)	-20 °C...60 °C
Storage temperature	-40 °C...70 °C
Humidity	5-95% rel. humidity, T <sub>v</sub> = 40°C, no condensation
Approvals	CE, EAC, GL
<b>Insulation coordination (EN 50178)</b>	
Rated voltage	300 V
Impulse withstand voltage	6 kV (1.2/50 µs)
Dielectric strength for control side - load side	2.5 kV <sub>eff</sub>
Dielectric strength to mounting rail	4 kV <sub>eff</sub> / 1 min.
Clearance and creepage distances for control side - load side	≥ 5.5 mm
Overvoltage category	III
Pollution degree	2
<b>Dimensions</b>	
Clamping range (nominal / min. / max.)	mm <sup>2</sup> 1.5 / 0.14 / 2.5
Depth x width x height	mm 88 / 12.8 / 90
<b>Note</b>	
Accessories and dimensional drawings: refer to the TERMSERIES Accessories page.	

**Ordering data**

	24 V DC	24 V - 230 V UC
<b>Control side</b>		
Rated control voltage	24 V DC ±20 %	24...230 V UC ±10 %
Nominal control current	10 mA DC ±20 %	28 mA @ 24 V UC, 4 mA @ 230 V UC
Power rating	240 mW	672 mW @ 24 V UC, 920 mW @ 230 V UC
Cut-in / dropout voltage	15 V / 5 V DC	12 V / 6 V AC 12 V / 5 V DC
Input frequency	3 Hz	3 Hz
Status indicator	Green LED	Green LED
Protective circuit	Reverse polarity protection, Integrated free-wheel diode	Rectifier
<b>Load side</b>		
Switch-on delay	< 1 ms	≤ 12 ms
Switch-off delay	< 4 ms	< 125 ms
<b>Ordering data</b>		
Screw connection Type	TOS 24VDC 230VAC1A	TOS 24-230VUC 230VAC1A
Order No.	<b>1127680000</b>	<b>1127690000</b>
Tension clamp conn. Type	TOZ 24VDC 230VAC1A	TOZ 24-230VUC 230VAC1A
Order No.	<b>1127700000</b>	<b>1127710000</b>
<b>Note</b>		
	Spare solid-state relay Type: SSR 10 - 32 VDC/ 12 - 275 VAC 3A Orderno.: 1132290000	Spare solid-state relay Type: SSR 10 - 32 VDC/ 12 - 275 VAC 3A Orderno.: 1132290000



1 CO contact, cl. 1, div. 2  
AC / DC / UC coil

- Space-saving, 6.4 mm wide
- AgNi contact

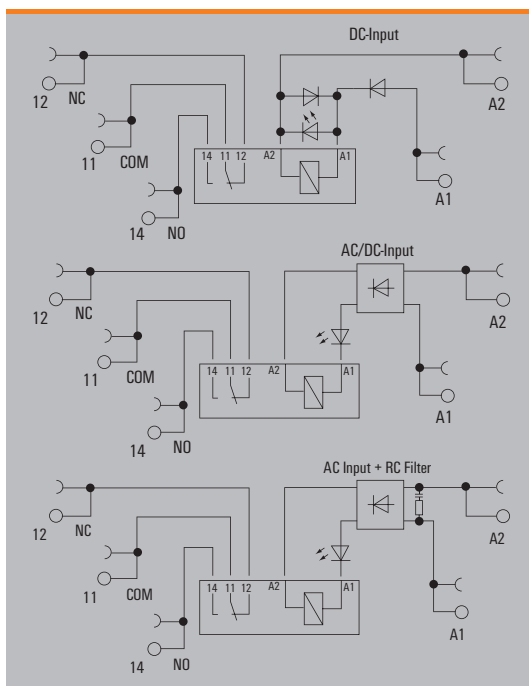
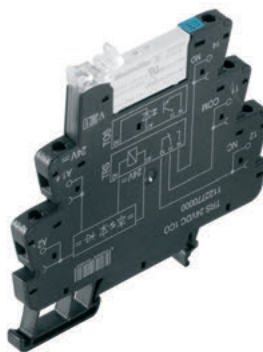

**Technical data**

Output	
Rated switching voltage / Continuous current	250 V AC / 6 A
Max. switching voltage, AC	250 V
Inrush current	20 A / 20 ms
Min. switching power	100 mA / 5 V, 12 V / 10 mA, 24 V / 1 mA
DC / AC Switching capacity (resistive), max.	144 W @ 24 V / 1500 VA
Contact material	AgNi
Mechanical service life	5 x 10 <sup>6</sup> switching cycles
Max. switching frequency at rated load	0.1 Hz
Rated data	
Ambient temperature (operational)	-40 °C...60 °C
Storage temperature	-40 °C...85 °C
Humidity	5-95% rel. humidity, T <sub>v</sub> = 40°C, no condensation
Approvals	CE, cULusEX
Insulation coordination (EN 50178)	
Rated voltage	300 V
Impulse withstand voltage	6 kV (1.2/50 µs)
Dielectric strength input - output	4 kV <sub>eff</sub> / 1 min.
Dielectric strength, contact / contact	
Dielectric strength to mounting rail	4 kV <sub>eff</sub> / 1 min.
Creepage and clearance distance input - output	≥ 5.5 mm
Overtoltage category	III
Pollution degree	2
Dimensions	
Clamping range (nominal / min. / max.)	mm <sup>2</sup> 1.5 / 0.14 / 2.5
Depth x width x height	mm 88 / 6.4 / 90
Screw connection	
<b>Note</b>	

**Applications**

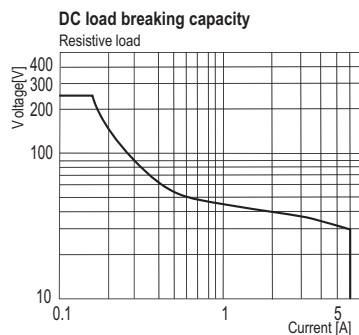
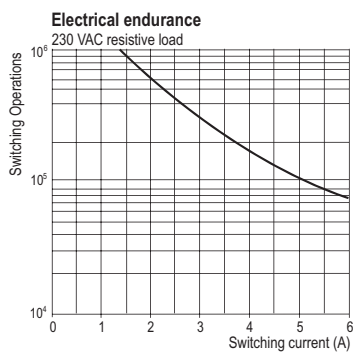

1 CO contact, cl. 1, div. 2  
AC / DC / UC coil

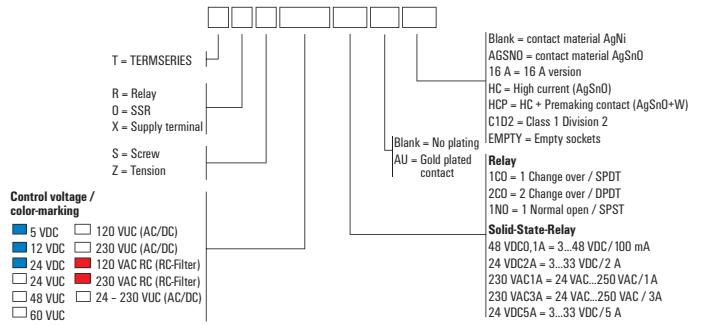

Ordering data	12 V DC	24 V DC	24 V UC	120 V AC RC	230 V AC RC
<b>Input</b>					
Rated control voltage	12 V DC ±20 %	24 V DC ±20 %	24 V UC ±10 %	120 V AC ±10 %	230 V AC ±10 %
Rated current AC / DC	/ 18 mA	/ 10 mA	11.7 mA / 6.4 mA	7 mA /	10.1 mA /
Power rating	210 mW	240 mW	270 mVA / 154 mW	0.84 VA	2.3 VA
Pull-in/drop-out voltage, typ.	8 V / 2 V DC	16 V / 4 V DC	16.5 V / 5.5 V AC 16.5 V / 5.5 V DC	79 V / 60 V AC	145 V / 85 V AC
Pull-in/drop-out current, typ.	9 mA / 3 mA DC	7 mA / 2 mA DC	4 mA / 1.2 mA AC 4 mA / 1.2 mA DC	4 mA / 2.5 mA AC	9.13 mA / 4.78 mA AC
Status indicator	Green LED	Green LED	Green LED	Green LED	Green LED
Protective circuit	Integrated free-wheel diode, Reverse polarity protection	Integrated free-wheel diode, Reverse polarity protection	Rectifier	Rectifier	Rectifier
<b>Output</b>					
Switch-on delay	< 7 ms	< 6 ms	< 4 ms	< 5.3 ms	< 22 ms
Switch-off delay	< 8 ms	< 7 ms	< 1.2 ms	< 4 ms	< 30 ms
<b>Ordering data</b>					
Screw connection	TRS 12VDC 1CO C1D2	TRS 24VDC 1CO C1D2	TRS 24VUC 1CO C1D2	TRS 120VACRC 1CO C1D2	TRS 230VACRC 1CO C1D2
Type Order No.	<b>1984560000</b>	<b>1984570000</b>	<b>1984580000</b>	<b>1984590000</b>	<b>1984600000</b>
Type Order No.					
<b>Note</b>					

Ordering data	24...230 V UC
<b>Input</b>	
Rated control voltage	24...230 V UC ±10 %
Rated current AC / DC	4 mA @ 230 V AC ±10 %, 28 mA @ 24 V AC ±10 % / 22 mA @ 24 V DC ±10 %
Power rating	530 mW @ 24 V DC, 930 mVA @ 230 V AC
Pull-in/drop-out voltage, typ.	11.5 V / 6 V AC 11.5 V / 5 V DC
Pull-in/drop-out current, typ.	
Status indicator	Green LED
Protective circuit	Rectifier
<b>Output</b>	
Switch-on delay	< 22 ms
Switch-off delay	< 100 ms
<b>Ordering data</b>	
Screw connection	TRS 24-230VUC 1CO C1D2
Type Order No.	<b>1984610000</b>
Type Order No.	
<b>Note</b>	

1 CO contact, cl. 1, div. 2  
 With hard gold-plated contacts  
 AC / DC / UC coil

- Space-saving, 6.4 mm wide
- AgNi contact

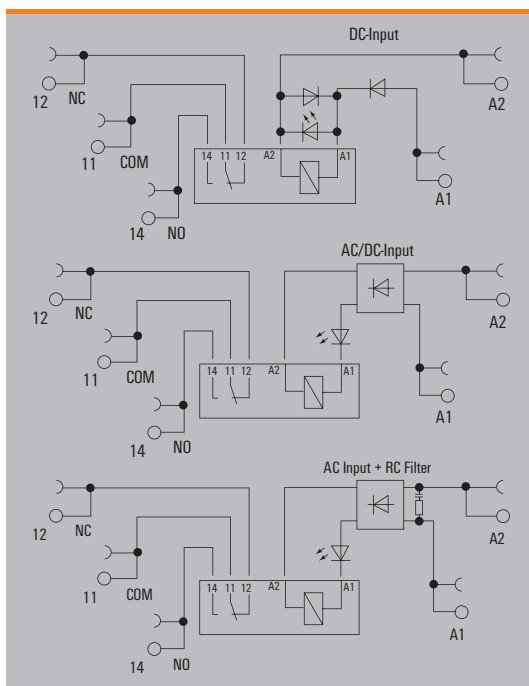
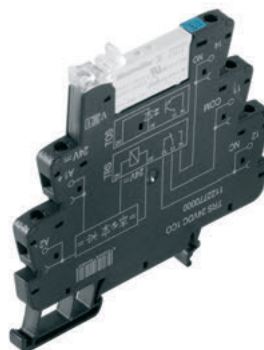

**Technical data**

Output	
Rated switching voltage / Continuous current	250 V AC / 6 A
Max. switching voltage, AC	250 V
Inrush current	20 A / 20 ms
Min. switching power	100 mA / 5 V, 12 V / 10 mA, 24 V / 1 mA
DC / AC Switching capacity (resistive), max.	144 W @ 24 V / 1500 VA
Contact material	AgNi
Mechanical service life	5 x 10 <sup>6</sup> switching cycles
Max. switching frequency at rated load	0.1 Hz
Rated data	
Ambient temperature (operational)	-40 °C...60 °C
Storage temperature	-40 °C...85 °C
Humidity	5-95% rel. humidity, T <sub>v</sub> = 40°C, no condensation
Approvals	CE, cULusEX
Insulation coordination (EN 50178)	
Rated voltage	300 V
Impulse withstand voltage	6 kV (1.2/50 µs)
Dielectric strength input - output	4 kV <sub>eff</sub> / 1 min.
Dielectric strength, contact / contact	
Dielectric strength to mounting rail	4 kV <sub>eff</sub> / 1 min.
Creepage and clearance distance input - output	≥ 5.5 mm
Overtoltage category	III
Pollution degree	2
Dimensions	
Clamping range (nominal / min. / max.)	mm <sup>2</sup> 1.5 / 0.14 / 2.5
Depth x width x height	mm 88 / 6.4 / 90
Screw connection	
<b>Note</b>	

**Applications**

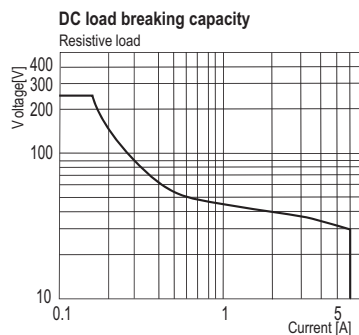
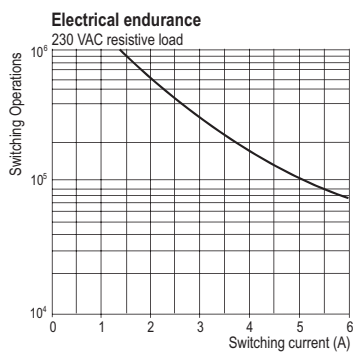

**1 CO contact, cl. 1, div. 2**  
**With hard gold-plated contacts**  
**AC / DC / UC coil**

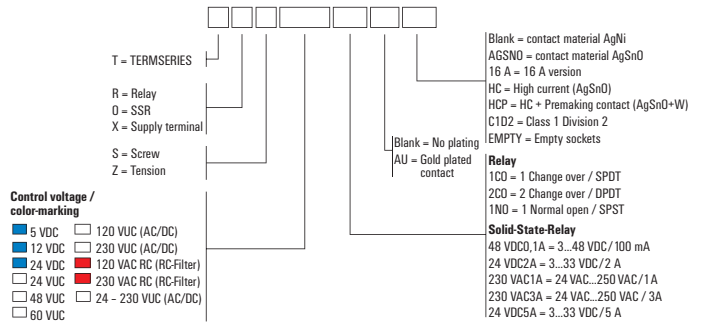

Ordering data	12 V DC	24 V DC	120 V AC RC	24-230 V UC
<b>Input</b>				
Rated control voltage	12 V DC ±20 %	24 V DC ±20 %	120 V AC ±10 %	24...230 V UC ±10 %
Rated current AC / DC	/ 18 mA	/ 10 mA	7 mA /	4 mA @ 230 V AC ±10 % 28 mA @ 24 V AC ±10 % / 22 mA @ 24 V DC ±10 %
Power rating	210 mW	240 mW	0.84 VA	530 mW @ 24 V DC, 930 mVA @ 230 V AC
Pull-in/drop-out voltage, typ.	8 V / 2 V DC	16 V / 4 V DC	79 V / 60 V AC	11.5 V / 6 V AC 11.5 V / 5 V DC
Pull-in/drop-out current, typ.	9 mA / 3 mA DC	7 mA / 2 mA DC	4 mA / 2.5 mA AC	
Status indicator	Green LED	Green LED	Green LED	Green LED
Protective circuit	Integrated free-wheel diode, Reverse polarity protection	Integrated free-wheel diode, Reverse polarity protection	Rectifier	Rectifier
<b>Output</b>				
Switch-on delay	< 7 ms	< 6 ms	< 5.3 ms	< 22 ms
Switch-off delay	< 8 ms	< 7 ms	< 4 ms	< 100 ms
<b>Ordering data</b>				
Screw connection	TRS 12VDC 1COAU C1D2	TRS 24VDC 1COAU C1D2	TRS 120VACRC 1COAU C1D2	TRS 24-230VUC 1COAUC1D2
Order No.	<b>1984620000</b>	<b>1984630000</b>	<b>1984640000</b>	<b>1984650000</b>
Type				
Order No.				
<b>Note</b>				

RSS relay module



Technical data	
Type of contact / Number of contacts	
Contact material	
Max. switching voltage / current	
Min. switching voltage / current	
Min. mechanical lifetime	
Min. electrical lifetime	
Max. switch-on / switch-off delay	
Ambient temperature (operational)	
Making / Dropout voltage coil	
<b>Note</b>	

RSS113...	RSS112...
1 CO contact	1 CO contact
AgNi	AgNi 5uAu <sup>3)</sup>
250 V / 6 A <sup>1)</sup>	250 V / 6 A <sup>1)</sup>
5 V / 100 mA <sup>2)</sup>	1 V / 1 mA
5 x 10 <sup>6</sup> <sup>1)</sup>	5 x 10 <sup>6</sup> <sup>1)</sup>
NO: 5 x 10 <sup>4</sup> ; NC: 3 x 10 <sup>4</sup> <sup>1)</sup>	NO: 5 x 10 <sup>4</sup> ; NC: 3 x 10 <sup>4</sup> <sup>1)</sup>
8 / 4 ms	8 / 4 ms
-40 °C ...+85 °C	-40 °C ...+85 °C
typ. 70 % / 5 % U <sub>NOM</sub>	typ. 70 % / 5 % U <sub>NOM</sub>
<b>Note</b>	
1) At resistive load	
2) 10 V / 10 mA; 24 V / 1 mA	
3) Au-plate operate up to 0.25 W	

Coil data
RSS...005
RSS...012
RSS...024
RSS...060

Nominal voltage / current
5 V DC / 34 mA
12 V DC / 14 mA
24 V DC / 7 mA
60 V DC / 3 mA

Order No.	Order No.
4061580000	1174540000
4061610000	1220670000
4060120000	4061590000
4061630000	4061600000

RCL relay module



Technical data	
Type of contact / Number of contacts	
Contact material	
Max. switching voltage / current	
Min. switching voltage / current	
Min. mechanical lifetime	
Min. electrical lifetime	
Max. switch-on / switch-off delay	
Ambient temperature (operational)	
Making / Dropout voltage coil	
<b>Note</b>	

RCL424...	RCL425...
2 CO contacts	2 CO contacts
AgNi	AgNi 5uAu <sup>3)</sup>
250 V / 8 A <sup>1)</sup>	250 V / 8 A <sup>1)</sup>
5 V / 100 mA <sup>2)</sup>	1 V / 1 mA
30 x 10 <sup>6</sup> <sup>1)</sup>	30 x 10 <sup>6</sup> <sup>1)</sup>
10 x 10 <sup>3</sup> <sup>1)</sup>	10 x 10 <sup>3</sup> <sup>1)</sup>
8 / 6 ms	8 / 6 ms
-40 °C ...+85 °C	-40 °C ...+85 °C
typ. 70 % / 10 % U <sub>NOM</sub>	typ. 70 % / 10 % U <sub>NOM</sub>
<b>Note</b>	
1) At resistive load	
2) 10 V / 10 mA; 24 V / 1 mA	
3) Au-plate operate up to 0.25 W	

Coil data
RCL...005
RCL...012
RCL...024
RCL...048
RCL...060
RCL...110

Nominal voltage / current	Nominal current
5 V DC / 80 mA	80 mA
12 V DC / 33 mA	33 mA
24 V DC / 16 mA	16 mA
48 V DC / 8 mA	8 mA
60 V DC / 6 mA	6 mA
110 V DC / 3 mA	3 mA

Order No.	Order No.
8693790000	1174490000
4058560000	4074580000
4058570000	4058580000
4058750000	1201230000
4058760000	1201260000
4058590000	8828370000



**Small solid-state relay**



Similar to illustration

Technical data	SSS...24 V 0.1 A DC	SSS...24 V 2 A DC	SSS...230 V 1 A AC
Output	Bipolar transistor	MOS-FET	TRIAC, zero cross switch
Switching voltage	0...48 V DC	0...24 V DC	24...240 V AC
Continuous current	100 mA	2 A	1 A
Peak reverse voltage	54 V	33 V	600 V
Forward voltage	< 1 V DC	< 120 mV	< 1 V
Test voltage input /output	2.5 kV	2.5 kV	3.75 kV
Ambient temperature (operational)	-20 °C ...+60 °C	-20 °C ...+60 °C	-20 °C ...+60 °C
Storage temperature	-40 °C ...+70 °C	-40 °C ...+70 °C	-40 °C ...+70 °C
Note			

Input
SSS 5 V...
SSS 24 V...
SSS 60 V...
SSS 5 V...
SSS 24 V...
SSS 60 V...
SSS 5 V...
SSS 24 V...
SSS 60 V...

Nominal voltage / current	Order No.	Order No.	Order No.
2.5...6 V DC / 4 mA	4064320000	-	-
16...30 V DC / 7 mA	4061180000	-	-
52...72 V DC / 3 mA	4061230000	-	-
2.5...6 V DC / 9 mA	-	4064310000	-
18...30 V DC / 7 mA	-	4061190000	-
40...72 V DC / 3 mA	-	4061200000	-
2.5...6 V DC / 15 mA	-	-	1132260000
18...30 V DC / 7 mA	-	-	4061210000
40...72 V DC / 3 mA	-	-	4061220000

**Solid-state relay**



Similar to illustration

Technical data	SSR.../0-35 V DC 3,5 A	SSR.../12-275 V AC 1 A
Output	MOS-FET	TRIAC, zero cross switch
Switching voltage	0...33 V DC	12...275 V AC
Continuous current	1 mA...3,5 A	50 mA...1 A
Peak reverse voltage	35 V	600 V
Forward voltage	< 300 mV	< 1.1 V
Test voltage input /output		2.5 kV
Ambient temperature (operational)		-20 °C ...+80 °C
Storage temperature		-40 °C ...+100 °C
Note		

Coil data
SSR10...32 V DC/...

Nominal voltage / current	Order No.	Order No.
10...32 V/3...13 mA	1132310000	1132290000

Empty socket 6.4 mm

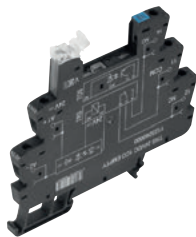

Input voltage	Qty.	Type / 1 CO, Screw connection	Order No.	Type / 1 CO, Tension clamp connection	Order No.
5 V DC <sup>1)</sup>	10	TRS 5VDC 1CO empty	1123220000	TRZ 5VDC 1CO empty	1123340000
12 V DC <sup>2)</sup>	10	TRS 12VDC 1CO empty	1123230000	TRZ 12VDC 1CO empty	1123350000
24 V DC <sup>3)</sup>	10	TRS 24VDC 1CO empty	1123240000	TRZ 24VDC 1CO empty	1123370000
24 V UC <sup>3)</sup>	10	TRS 24VUC 1CO empty	1123250000	TRZ 24VUC 1CO empty	1123380000
48 V UC <sup>3)</sup>	10	TRS 48VUC 1CO empty	1123270000	TRZ 48VUC 1CO empty	1123390000
60 V UC <sup>4)</sup>	10	TRS 60VUC 1CO empty	1123280000	TRZ 60VUC 1CO empty	1123400000
120 V UC <sup>4)</sup>	10	TRS 120VUC 1CO empty	1123290000	TRZ 120VUC 1CO empty	1123410000
230 V UC <sup>4)</sup>	10	TRS 230VUC 1CO empty	1123300000	TRZ 230VUC 1CO empty	1123420000
120 V AC <sup>4)</sup>	10	TRS 120VAC RC 1CO empty	1123310000	TRZ 120VAC RC 1CO empty	1123430000
230 V AC <sup>4)</sup>	10	TRS 230VAC RC 1CO empty	1123320000	TRZ 230VAC RC 1CO empty	1123440000
24...230 V AC / DC <sup>3)</sup>	10	TRS 24-230VUC 1CO empty	1123330000	TRZ 24-230VUC 1CO empty	1123450000

Useable with <sup>1)</sup>RSS...005; SSS 5V...      <sup>2)</sup>RSS...012 <sup>3)</sup>RSS...024; SSS 24V...      <sup>4)</sup>RSS...60V; SSS 60V...

Empty socket 12.8 mm

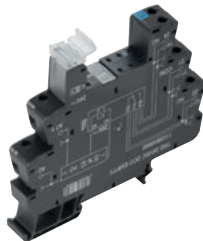

Input voltage	Qty.	Type / 1 CO, Screw connection	Order No.	Type / 1 CO, Tension clamp connection	Order No.
24 V DC	10	TOS 24VDC empty	1127720000	TOZ 24VDC empty	1127740000
24...230 V UC	10	TOS 24-230VUC empty	1127730000	TOZ 24-230VUC empty	1127750000
Input voltage	Qty.	Type / 2 CO, Screw connection	Order No.	Type / 2 CO, Tension clamp connection	Order No.
5 V DC <sup>2)</sup>	10	TRS 5VDC 2CO empty	1123950000	TRZ 5VDC 2CO empty	1124080000
12 V DC <sup>3)</sup>	10	TRS 12VDC 2CO empty	1123970000	TRZ 12VDC 2CO empty	1124090000
24 V DC <sup>4)</sup>	10	TRS 24VDC 2CO empty	1123980000	TRZ 24VDC 2CO empty	1124100000
24 V UC <sup>4)</sup>	10	TRS 24VUC 2CO empty	1123990000	TRZ 24VUC 2CO empty	1124110000
48 V UC <sup>5)</sup>	10	TRS 48VUC 2CO empty	1124000000	TRZ 48VUC 2CO empty	1124120000
60 V UC <sup>6)</sup>	10	TRS 60VUC 2CO empty	1124010000	TRZ 60VUC 2CO empty	1124130000
120 V UC <sup>7)</sup>	10	TRS 120VUC 2CO empty	1124020000	TRZ 120VUC 2CO empty	1124140000
230 V UC <sup>7)</sup>	10	TRS 230VUC 2CO empty	1124030000	TRZ 230VUC 2CO empty	1124150000
120 V AC <sup>7)</sup>	10	TRS 120VAC RC 2CO empty	1124040000	TRZ 120VAC RC 2CO empty	1124170000
230 V AC <sup>7)</sup>	10	TRS 230VAC RC 2CO empty	1124050000	TRZ 230VAC RC 2CO empty	1124180000
24...230 V AC / DC <sup>7)</sup>	10	TRS 24-230VUC 2CO empty	1124070000	TRZ 24-230VUC 2CO empty	1124190000

Useable with <sup>1)</sup>RCL31024; SSR 10...32VDC/...      <sup>2)</sup>RCL42005, <sup>3)</sup>RCL42012      <sup>4)</sup>RCL42024      <sup>5)</sup>RCL42048, <sup>6)</sup>RCL42060,      <sup>7)</sup>RCL42110

Technical data

Conductor		Screw connection		Tension clamp connection	
Plug gauge to IEC 60947-1	Size	A1 / B1		A1 / B1	
1 conductor					
Solid HO7V-U	mm <sup>2</sup>	0.14...2.5		0.14...1.5	
Stranded HO7V-K	mm <sup>2</sup>	0.14...1.5		0.14...1.5	
... with wire end ferrule	mm <sup>2</sup>	0.25...1.5		0.14...1.5	
... with wire end ferrule with plastic collar	mm <sup>2</sup>	0.25...1.5		0.14...1.5	
Clamping range AWG.../1	AWG	26...14		26...16	
Clamping range AWG.../7	AWG	26...16		26...16	
Clamping range AWG.../19	AWG	26...16		26...16	
2 conductor with same size					
Solid HO7V-U	mm <sup>2</sup>	0.5...1.0			
Stranded HO7V-K	mm <sup>2</sup>	0.5...1.0			
... with twin wire end ferrule H...D ZH	mm <sup>2</sup>	0.5...1.0		0.5...1.0	
General data					
Nominal torque	Nm	0.4			
Stripping length	mm	8		8	
Continuous current ZQV 1.5N/R6.4	A	17.5; UL: 10		17.5; UL: 10	
No. Contact durability relay / ZQV		10		10	
Note					

**Pluggable cross connection**



Type	No. of poles / Pitch	Colour	Qty.	Order No.
ZQV 1.5N/R6.4/2 GE	2 / 6.4 mm	yellow	10	1193670000
ZQV 1.5N/R6.4/10 GE	10 / 6.4 mm	yellow	10	1193680000
ZQV 1.5N/R6.4/19 GE	19 / 6.4 mm	yellow	10	1193690000
ZQV 1.5N/R12.8/10 GE	10 / 12.8 mm	yellow	10	1193700000
ZQV 1.5N/R6.4/10 SW	10 / 6.4 mm	black	10	1391630000
ZQV 1.5N/R6.4/19 SW	19 / 6.4 mm	black	10	1391600000
ZQV 1.5N/R6.4/10 RT	10 / 6.4 mm	red	10	1391640000
ZQV 1.5N/R6.4/19 RT	19 / 6.4 mm	red	10	1391610000
ZQV 1.5N/R6.4/10 BL	10 / 6.4 mm	blue	10	1390350000
ZQV 1.5N/R6.4/19 BL	19 / 6.4 mm	blue	10	1391620000

**Supply terminal**



Type	Connection technology	Qty.	Order No.
TXS SUPPLY	Screw connection	10	1240780000
TXZ SUPPLY	Tension clamp connection	10	1240790000

**Other accessories**



Isolation plate	Note	Qty.	Order No.
TW TXS/TXZ R3.2	Isolation plate 3.2 mm pitch	10	1240800000

Markers	Note	Qty.	Order No.
WS 10/6 MC Middle	10 * 6 mm	600	1818400000



Screwdriver	Note	Qty.	Order No.
SDK PH0	only screw connection	1	9008470000
SD 0.6 x 3.5 x 100		1	9008330000
SD TO 0.6 x 3.0	only tension clamp connection (angled)	1	1323880000

End bracket	Qty.	Order No.
WEW35/2 SW	100	1061210000

**Dimensions**

**Tension clamp connection**

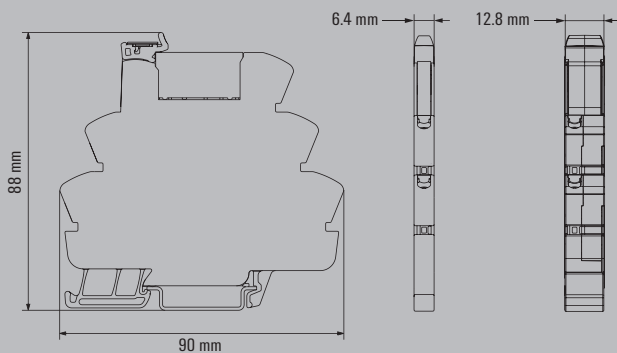

**Screw connection**

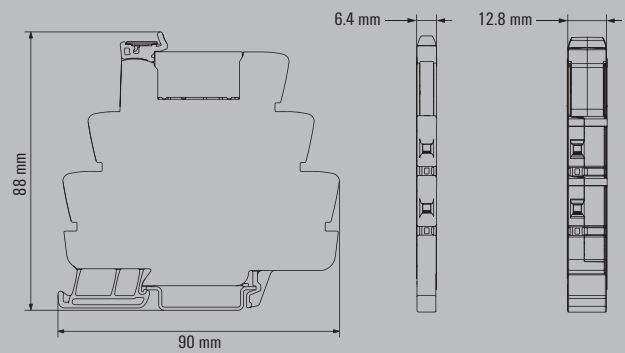

**TERMSERIES adapters**

**TERMSERIES adapters**

- Suitable for input and output logic
- Version for 6.4 mm TERMSERIES base
- Supply connections (PUSH IN) in double execution for simple supply voltage bridging
- User-friendly and unique marking
- 10-pin connecting plug according to DIN EN 60603-13

**TIA F10**

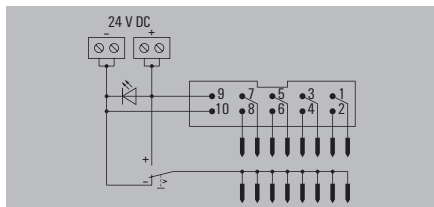

**Technical data**

**Supply**

Supply voltage  
Status display

**Signals**

Rated voltage  
Voltage, max.  
Rated current (per signal path)  
Current (per signal path), max.  
Total current of all signals, max.  
Number of signal paths

**Connection data (supply)**

Wire connection method  
Clamping range, rated connection, min.  
Clamping range, rated connection, max.  
Number of terminals

**Connection data (signal)**

Plug type

**General data**

Ambient temperature (operational)  
Storage temperature  
Humidity  
UL 94 flammability rating  
Approvals

**Insulation coordination**

Pollution degree  
Overvoltage category  
Impulse withstand voltage  
Rated voltage  
Protection degree

**Dimensions**

Depth x width x height mm

**Note**

**Ordering data**

Type	Qty.	Order No.
TIA F10	1	1463520000

**Note**

24 V DC ± 20 %

Green LED

24 V DC

30 V DC

125 mA

1 A

1 A

8

PUSH IN

0.13 mm<sup>2</sup>

1.5 mm<sup>2</sup>

4 (+, +, -, -)

10-pole plug according to DIN EN 60603-13, long locking lever

-40 °C...60 °C

-40 °C...85 °C

5...95% (indoor), T<sub>a</sub> = 40°C, no condensation

V-0

CE; cULus; GL

2

III

1.5 kV

32 V

IP 20 in installed condition

62 / 51 / 43

Suitable for 6.4 mm wide TERMSERIES base

**Accessories**

**Note**

**Potential change-over switch**

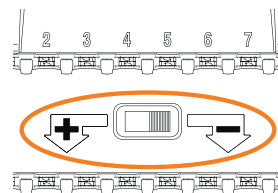

The potential change-over switch is located between contact rows of the TERMSERIES adaptor. It is used to switch the potential of the lower contact row to "+" or "-" potential of the supply voltage.

**Installation input**

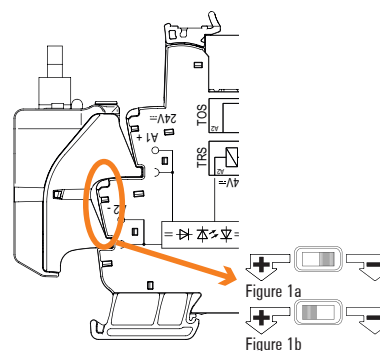

Figure 1a: **Positive-switching logic:** Potential change-over switch to "+", installation on **24 V DC input** (A1/A2).

Figure 1b: **Negative-switching logic:** Potential change-over switch to "-", installation on **24 V UC input** (A1/A2).

**Installation output**

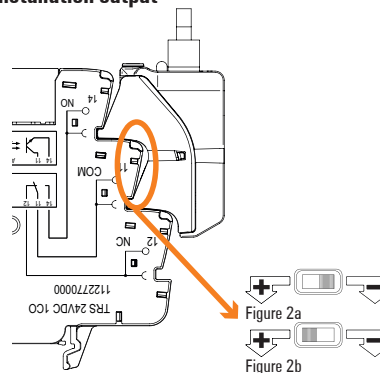

Figure 2a: **Positive-switching logic:** Potential change-over switch to "+", installation on **output** (11/14).

Figure 2b: **Negative-switching logic:** Potential change-over switch to "-", installation on **output** (11/14).

**TERMSERIES adapters**

- Suitable for input and output logic
- Version for 6.4 mm TERMSERIES base
- User-friendly and unique marking
- 15-pin sub-D plug according to DIN 41652 / IEC 60807

**TIA SUBD 15S**

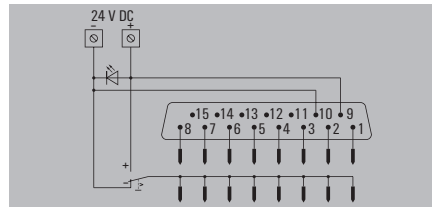

**Technical data**

**Supply**

Supply voltage  
Status display

**Signals**

Rated voltage  
Voltage, max.  
Rated current (per signal path)  
Current (per signal path), max.  
Total current of all signals, max.  
Number of signal paths

**Connection data (supply)**

Wire connection method  
Clamping range, rated connection, min.  
Clamping range, rated connection, max.  
Number of terminals

**Connection data (signal)**

Plug type

**General data**

Ambient temperature (operational)  
Storage temperature  
Humidity  
UL 94 flammability rating  
Approvals

**Insulation coordination**

Pollution degree  
Overvoltage category  
Impulse withstand voltage  
Rated voltage  
Protection degree

**Dimensions**

Depth x width x height mm

**Note**

**Ordering data**

**Supply**

24 V DC ± 20 %  
Green LED

**Signals**

24 V DC  
30 V DC  
125 mA  
1 A  
1 A  
8

**Connection data (supply)**

PUSH IN  
0.13 mm<sup>2</sup>  
1.5 mm<sup>2</sup>  
2 (+,-)

**Connection data (signal)**

Sub-D, 15-pole, DIN 41652 / IEC 60807

**General data**

-40 °C...60 °C  
-40 °C...85 °C  
5...95% (indoor), T<sub>v</sub> = 40°C, no condensation  
V-0  
CE; cULus; GL

**Insulation coordination**

2  
III  
1.5 kV  
32 V  
IP 20 in installed condition

52 / 51 / 43

**Note**

Type	Qty.	Order No.
TIA SUBD 15S	1	1463530000

**Note**

Suitable for 6.4 mm wide TERMSERIES base

**Accessories**

**Note**

**Potential change-over switch**

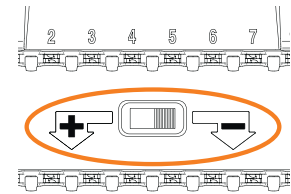

The potential change-over switch is located between contact rows of the TERMSERIES adaptor. It is used to switch the potential of the lower contact row to "+" or "-" potential of the supply voltage.

**Installation input**

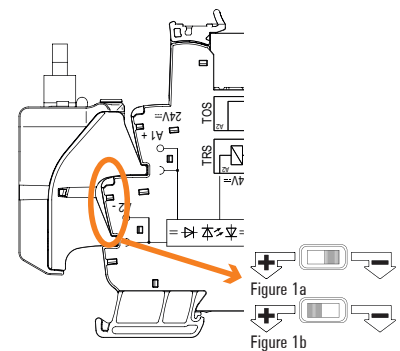

Figure 1a: **Positive-switching logic:** Potential change-over switch to "-", installation on **24 V DC input** (A1/A2).  
Figure 1b: **Negative-switching logic:** Potential change-over switch to "+", installation on **24 V UC input** (A1/A2).

**Installation output**

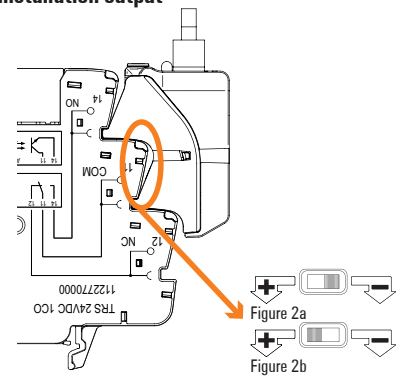

Figure 2a: **Positive-switching logic:** Potential change-over switch to "+", installation on output (11/14).  
Figure 2b: **Negative-switching logic:** Potential change-over switch to "-", installation on output (11/14).

**TERMSERIES adapters**

**TERMSERIES adapters**

- Suitable for input and output logic
- Version for 12.8 mm TERMSERIES base
- Supply connections (PUSH IN) in double execution for simple supply voltage bridging
- User-friendly and unique marking
- 10-pin connecting plug according to DIN EN 60603-13

**TIAL F10**

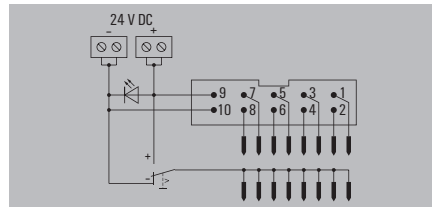

**Technical data**

<b>Supply</b>	
Supply voltage	24 V DC ± 20 %
Status display	Green LED
<b>Signals</b>	
Rated voltage	24 V DC
Voltage, max.	30 V DC
Rated current (per signal path)	125 mA
Current (per signal path), max.	1 A
Total current of all signals, max.	1 A
Number of signal paths	8
<b>Connection data (supply)</b>	
Wire connection method	PUSH IN
Clamping range, rated connection, min.	0.13 mm <sup>2</sup>
Clamping range, rated connection, max.	1.5 mm <sup>2</sup>
Number of terminals	4 (+, +, -, -)
<b>Connection data (signal)</b>	
Plug type	10-pole plug according to DIN EN 60603-13, long locking lever
<b>General data</b>	
Ambient temperature (operational)	-40 °C...60 °C
Storage temperature	-40 °C...85 °C
Humidity	5...95% (indoor), T <sub>v</sub> = 40°C, no condensation
UL 94 flammability rating	V-0
Approvals	CE; cULus; GL
<b>Insulation coordination</b>	
Pollution degree	2
Overvoltage category	III
Impulse withstand voltage	1.5 kV
Rated voltage	32 V
Protection degree	IP 20 in installed condition

<b>Dimensions</b>	
Depth x width x height	mm 62 / 102 / 43

<b>Note</b>	
-------------	--

**Ordering data**

Type	Qty.	Order No.
TIAL F10	1	1463540000

<b>Note</b>	Suitable for 12.8 mm wide TERMSERIES base
-------------	---

**Accessories**

<b>Note</b>	
-------------	--

**Potential change-over switch**

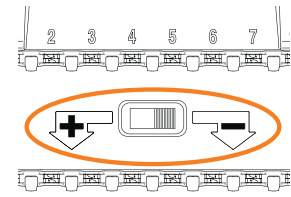

The potential change-over switch is located between contact rows of the TERMSERIES adaptor. It is used to switch the potential of the lower contact row to "+" or "-" potential of the supply voltage.

**Installation input**

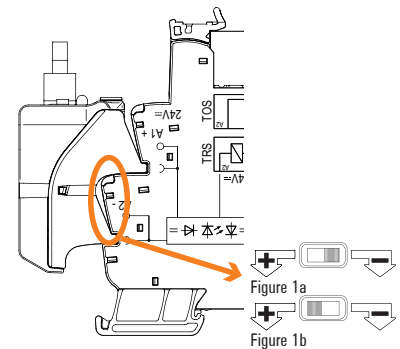

Figure 1a: **Positive-switching logic:** Potential change-over switch to "-", installation on **24 V DC input** (A1/A2).  
Figure 1b: **Negative-switching logic:** Potential change-over switch to "+", installation on **24 V UC input** (A1/A2).

**Installation output**

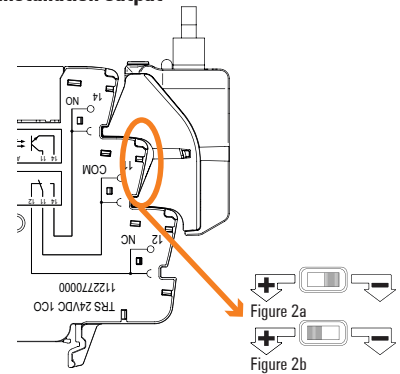
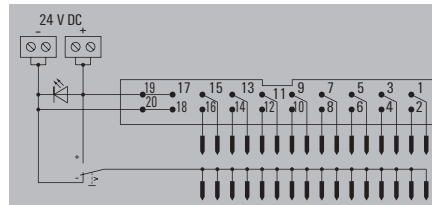

Figure 2a: **Positive-switching logic:** Potential change-over switch to "+", installation on **output** (11/14).  
Figure 2b: **Negative-switching logic:** Potential change-over switch to "-", installation on **output** (11/14).

**TERMSERIES adapters**

- Suitable for input and output logic
- Version for 6.4 mm TERMSERIES base
- Supply connections (PUSH IN) in double execution for simple supply voltage bridging
- User-friendly and unique marking
- 20-pin connecting plug according to DIN EN 60603-13

**TIAL F20**



**Technical data**

<b>Supply</b>	
Supply voltage	24 V DC ± 20 %
Status display	Green LED
<b>Signals</b>	
Rated voltage	24 V DC
Voltage, max.	30 V DC
Rated current (per signal path)	60 mA
Current (per signal path), max.	1 A
Total current of all signals, max.	1 A
Number of signal paths	16
<b>Connection data (supply)</b>	
Wire connection method	PUSH IN
Clamping range, rated connection, min.	0.13 mm <sup>2</sup>
Clamping range, rated connection, max.	1.5 mm <sup>2</sup>
Number of terminals	4 (+, +, -, -)
<b>Connection data (signal)</b>	
Plug type	20-pole plug according to DIN EN 60603-13, long locking lever
<b>General data</b>	
Ambient temperature (operational)	-40 °C...60 °C
Storage temperature	-40 °C...85 °C
Humidity	5...95% (indoor, T <sub>a</sub> = 40°C, no condensation)
UL 94 flammability rating	V-0
Approvals	CE; cULus; GL
<b>Insulation coordination</b>	
Pollution degree	2
Overvoltage category	III
Impulse withstand voltage	1.5 kV
Rated voltage	32 V
Protection degree	IP 20 in installed condition

<b>Dimensions</b>	
Depth x width x height	62 / 102 / 43 mm
<b>Note</b>	
Suitable for 6.4 mm wide TERMSERIES base	

**Dimensions**

Depth x width x height	62 / 102 / 43 mm
------------------------	------------------

<b>Note</b>	Suitable for 6.4 mm wide TERMSERIES base
-------------	--

**Ordering data**

Type	Qty.	Order No.
TIAL F20	1	1463550000

<b>Note</b>	Suitable for 6.4 mm wide TERMSERIES base
-------------	--

**Accessories**

<b>Note</b>	
-------------	--

**Potential change-over switch**

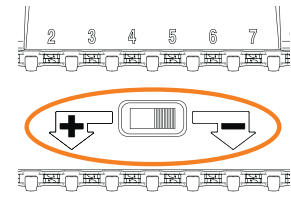

The potential change-over switch is located between contact rows of the TERMSERIES adaptor. It is used to switch the potential of the lower contact row to "+" or "-" potential of the supply voltage.

**Installation input**

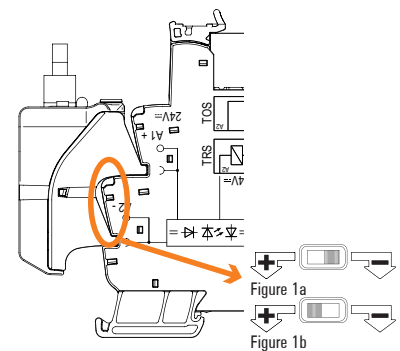

Figure 1a: **Positive-switching logic:** Potential change-over switch to "-", installation on **24 V DC input** (A1/A2).  
Figure 1b: **Negative-switching logic:** Potential change-over switch to "+", installation on **24 V UC input** (A1/A2).

**Installation output**

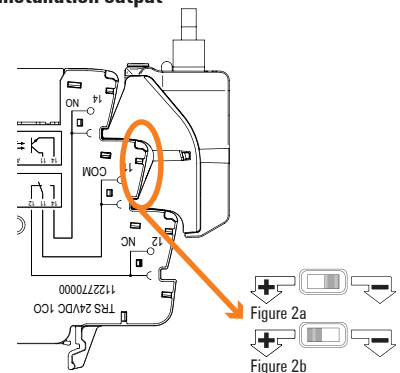

Figure 2a: **Positive-switching logic:** Potential change-over switch to "+", installation on output (11/14).  
Figure 2b: **Negative-switching logic:** Potential change-over switch to "-", installation on output (11/14).



# No-wear isolation of potentials in terminal block design



A

## Space saving solid-state relay with "PUSH IN" connection technology

The TERMOPTO opto modules are characterised by a particularly compact design, pluggable cross-connections and an optimal price-performance ratio.

TERMOPTO offers a compact, electronic alternative to the electromechanical relay for electrical isolation and signal conditioning. Instead of an electromechanical solution that is susceptible to wear, a maintenance-free and compact terminal block with integrated electrical isolation is used. This saves space, reduces the amount of servicing and increases system availability. In addition, the overall accessory needs are reduced, because cross-connectors and markers from the terminal portfolio can be used.

### Compact

Compact design reduces space requirements in the switching cabinet by > 80 % compared to conventional relay solutions.

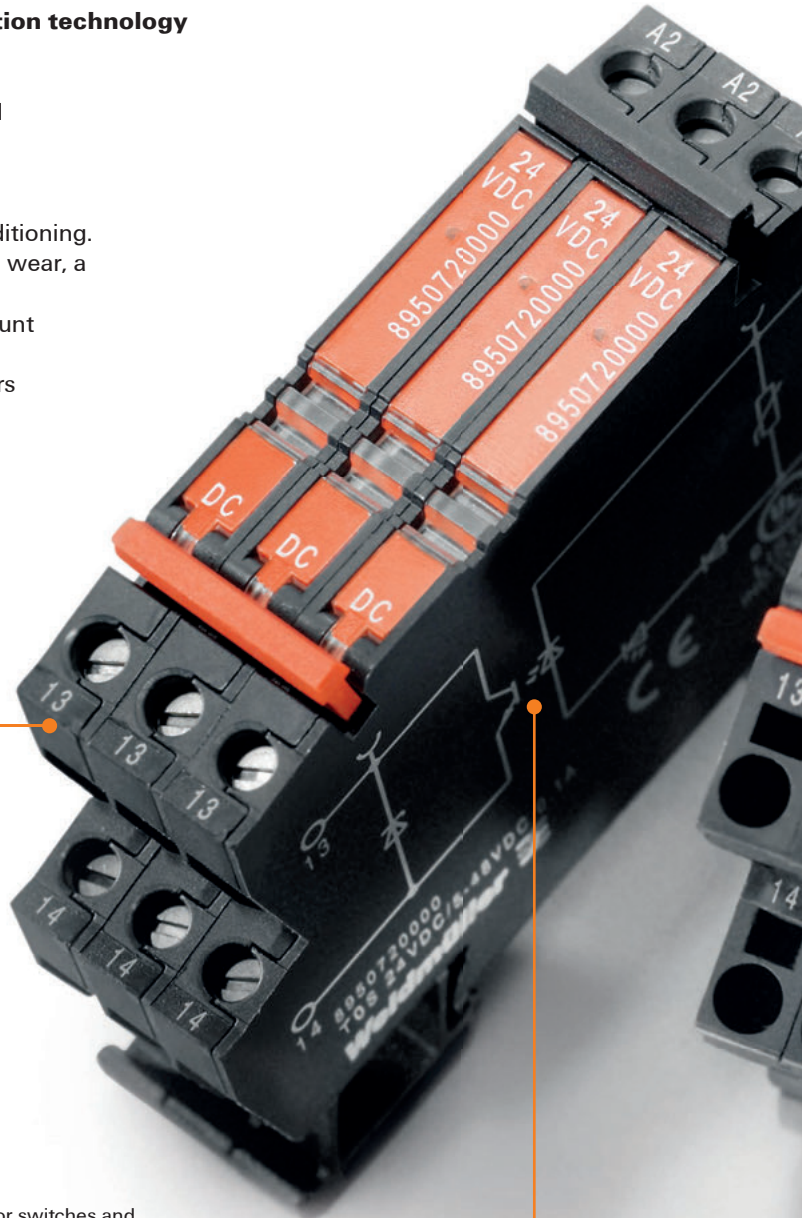
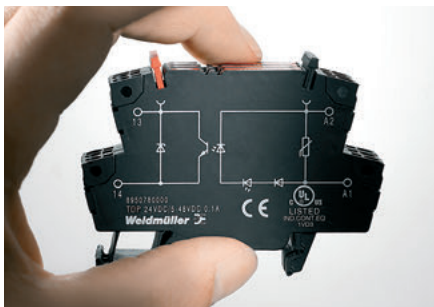

### Long lifetime

Wear-free semiconductor switches and extensive protective circuits ensure long service life and reliable switching cycles.

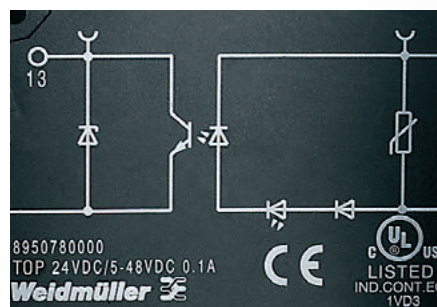

**Status indicator**

LED status indicator provides information on the switching state.



**Closed design**

Closed design for space-saving, side-by-side arrangement. No end plate necessary; the electronics are mechanically protected.



**Time-saving**

PUSH IN screwless connection system and the pluggable cross-connection reduce wiring time by > 50 %.

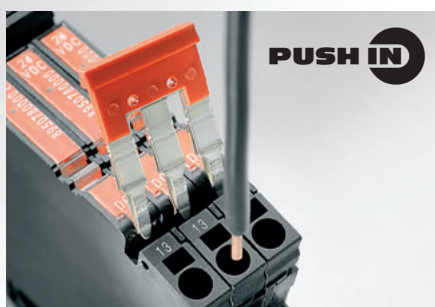

**TERMOPTO – solid-state relays**

**Solid-state relays 5...48 V DC / 100 mA**

**Output versions**

- Space-saving 6.1 mm width
- Plug-in cross-connections
- Screw and PUSH IN wire connection
- Enclosed design

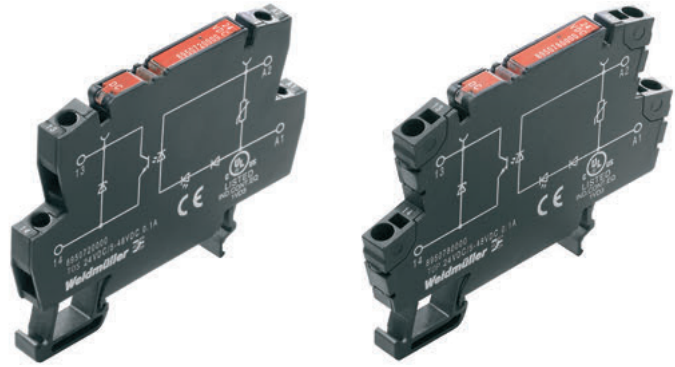

**5 V DC**

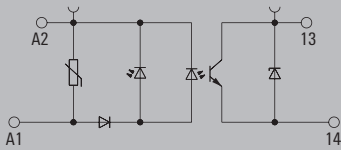

**12...220 DC**

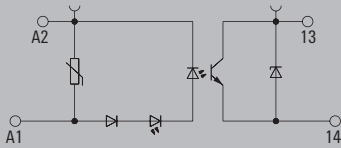

**24...230 V AC**

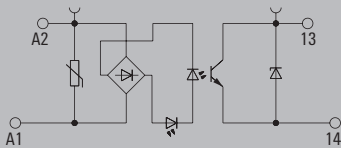

**Technical data**

Load side		
Rated switching voltage	5...48 V DC	
Continuous current	100 mA	
Inrush current		
Solid-state type	Transistor	
Voltage drop at max. load	< 1 V	
Leakage current	< 10 µA	
Protective circuit, load side	Integrated free-wheel diode	
Short-circuit-proof / Protective circuit, load side	No / Integrated free-wheel diode	
General data		
Ambient temperature (operational)	-20 °C...60 °C	
Storage temperature	-40 °C...80 °C	
Humidity	5-95% rel. humidity, T <sub>v</sub> = 40°C, no condensation	
Approvals	CE, cULus, EAC	
Insulation coordination (EN 50178)		
Rated voltage	300 V	
Impulse withstand voltage	4 kV (1.2/50 µs)	
Dielectric strength for control side - load side	1.2 kV <sub>eff</sub> / 1 min.	
Dielectric strength to mounting rail		
Clearance and creepage distances for control side - load side	> 3 mm	
Overvoltage category	III	
Pollution degree	2	
Dimensions		
Clamping range (nominal / min. / max.)	Screw connection	2.5 / 0.5 / 2.5
	PUSH IN connection	1.5 / 0.5 / 2.5
Depth x width x height	Screw connection	55 / 6.1 / 74.5
	PUSH IN connection	55 / 6.1 / 79.5
<b>Note</b>	Accessories and dimensioned drawings: refer to the TERMOPTO Accessories page.	

**Applications**

The **TERMOPTO** opto module is used in industrial applications in which electrical isolation and signal conditioning without switching amplification is sufficient.

The compact design in terminal-block format saves space on the rail and offers the option of a pluggable cross connection.

The choice between 10 input voltages and 3 output voltages, as well as screw or PUSH IN connection technology, gives 60 variations for different applications.

The integrated protective circuit ensures sufficient protection in applications with resistive, as well as slightly inductive and capacitive loads. For purely inductive, capacitive or comparable loads with high switch-on and switch-off peaks, such as solenoid valves or filament lamps, ensure that the module is dimensioned appropriately or an additional safeguard is used.

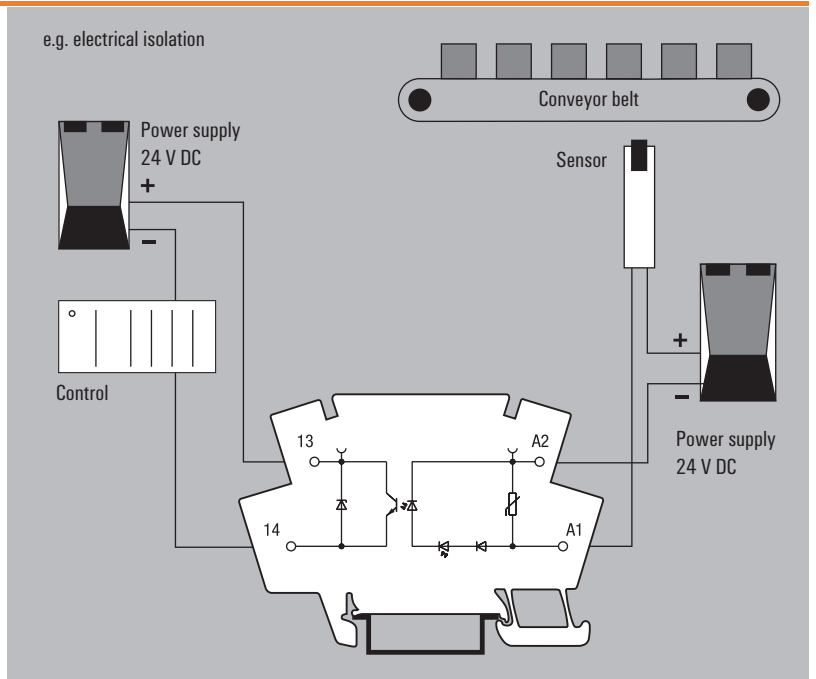

Solid-state relays 5...48 V DC / 100 mA

Output versions

Ordering data	5 V DC	12 V DC	24 V DC	48...60 V DC	110 V DC
<b>Control side</b>					
Rated control voltage	5 V DC ±20 %	12 V DC ±20 %	24 V DC ±20 %	48...60 V DC ±20 %	110 V DC ±20 %
Nominal control current	7.7 mA DC	7.8 mA DC	7 mA DC	4.3 mA DC	2.6 mA DC
Power rating	< 40 mW	< 95 mW	≤ 170 mW	< 200 mW	< 280 mW
Cut-in / dropout voltage	4 V / 1.25 V DC	9.6 V / 3 V DC	19.2 V / 6 V DC	38.4 V / 12 V DC	88 V / 27.5 V DC
Input frequency	3 kHz	3 kHz	3 kHz	500 Hz	500 Hz
Status indicator	Green LED	Green LED	Green LED	Green LED	Green LED
Protective circuit	Varistor, rev. polarity protection	Varistor, rev. polarity protection	Varistor, rev. polarity protection	Varistor, rev. polarity protection	Varistor, rev. polarity protection
<b>Load side</b>					
Switch-on delay	< 13 µs	< 13 µs	< 13 µs	< 170 µs	< 170 µs
Switch-off delay	< 42 µs	< 42 µs	< 42 µs	< 310 µs	< 310 µs

Ordering data						
Screw connection	Type	TOS 5VDC/48VDC 0,1A	TOS 12VDC/48VDC 0,1A	TOS 24VDC/48VDC 0,1A	TOS 48-60VDC/48VDC 0,1A	TOS 110VDC/48VDC 0,1A
	Order No.	<b>8950700000</b>	<b>8950710000</b>	<b>8950720000</b>	<b>8950730000</b>	<b>8950740000</b>
PUSH IN connection	Type	TOP 5VDC/48VDC 0,1A	TOP 12VDC/48VDC 0,1A	TOP 24VDC/48VDC 0,1A	TOP 48-60VDC/48VDC 0,1A	TOP 110VDC/48VDC 0,1A
	Order No.	<b>8950760000</b>	<b>8950770000</b>	<b>8950780000</b>	<b>8950790000</b>	<b>8950800000</b>
<b>Note</b>						

Ordering data	220 V DC	24 V AC	48...60 V AC	120 V AC	230 V AC
<b>Control side</b>					
Rated control voltage	220 V DC +10 % / -15 %	24 V AC ±20%	48...60 V AC ±20 %	120 V AC ±20 %	230 V AC +10 % / -20 %
Nominal control current	1.65 mA DC	7.4 mA AC	4.3 mA AC	2.9 mA AC	1.75 mA AC
Power rating	≤ 360 mW	< 0.18 VA	≤ 0.2 VA	≤ 0.3 VA	≤ 0.4 VA
Cut-in / dropout voltage	187 V / 55 V DC	21.6 V / 9.6 V AC	38.4 V / 19.2 V AC	102 V / 48 V AC	207 V / 92 V AC
Input frequency	500 Hz	10 Hz	10 Hz	10 Hz	10 Hz
Status indicator	Green LED	Green LED	Green LED	Green LED	Green LED
Protective circuit	Varistor, rev. polarity protection	Varistor	Varistor	Varistor	Varistor
<b>Load side</b>					
Switch-on delay	< 170 µs	< 12 ms	< 12 ms	< 12 ms	< 12 ms
Switch-off delay	< 310 µs	< 14 ms	< 14 ms	< 14 ms	< 14 ms

Ordering data						
Screw connection	Type	TOS 220VDC/48VDC 0,1A	TOS 24VAC/48VDC 0,1A	TOS 48-60VAC/48VDC 0,1A	TOS 120VAC/48VDC 0,1A	TOS 230VAC/48VDC 0,1A
	Order No.	<b>8950750000</b>	<b>8950820000</b>	<b>8950830000</b>	<b>8950840000</b>	<b>8950850000</b>
PUSH IN connection	Type	TOP 220VDC/48VDC 0,1A	TOP 24VAC/48VDC 0,1A	TOP 48-60VAC/48VDC 0,1A	TOP 120VAC/48VDC 0,1A	TOP 230VAC/48VDC 0,1A
	Order No.	<b>8950810000</b>	<b>8950860000</b>	<b>8950870000</b>	<b>8950880000</b>	<b>8950890000</b>
<b>Note</b>						



**TERMOPTO – solid-state relays**

**Solid-state relays, 5...48 V DC / 500 mA**

**Output versions**

- Space-saving 6.1 mm width
- Plug-in cross-connections
- Screw and PUSH IN wire connection
- Enclosed design

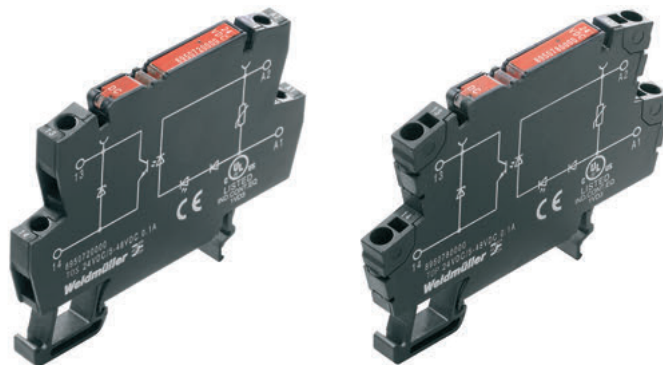

**5 V DC**

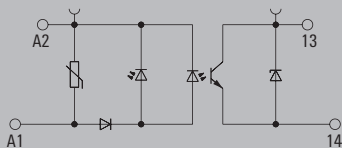

**12...220 DC**

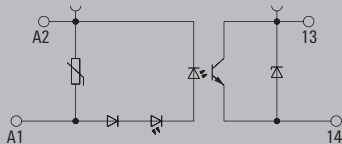

**24...230 V AC**

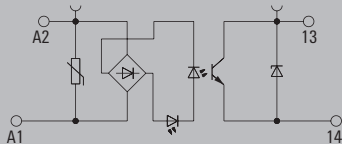

**Technical data**

Load side			
Rated switching voltage	5...48 V DC		
Continuous current	500 mA		
Inrush current			
Solid-state type	Transistor		
Voltage drop at max. load	< 1 V		
Leakage current	< 10 µA		
Protective circuit, load side	Integrated free-wheel diode		
Short-circuit-proof / Protective circuit, load side	No / Integrated free-wheel diode		
General data			
Ambient temperature (operational)	-20 °C...60 °C		
Storage temperature	-40 °C...80 °C		
Humidity	5-95% rel. humidity, T <sub>v</sub> = 40°C, no condensation		
Approvals	CE, cULus, EAC		
Insulation coordination (EN 50178)			
Rated voltage	300 V		
Impulse withstand voltage	4 kV (1.2/50 µs)		
Dielectric strength for control side - load side	1.2 kV <sub>eff</sub> / 1 min.		
Dielectric strength to mounting rail			
Clearance and creepage distances for control side - load side	> 3 mm		
Overvoltage category	III		
Pollution degree	2		
Dimensions			
Clamping range (nominal / min. / max.)	mm <sup>2</sup>	<b>Screw connection</b> 2.5 / 0.5 / 2.5	<b>PUSH IN connection</b> 1.5 / 0.5 / 2.5
	mm	55 / 6.1 / 74.5	55 / 6.1 / 79.5
<b>Note</b>		Accessories and dimensioned drawings: refer to the TERMOPTO Accessories page.	

**Applications**

The **TERMOPTO** opto module is used in industrial applications in which electrical isolation and signal conditioning without switching amplification is sufficient.

The compact design in terminal-block format saves space on the rail and offers the option of a pluggable cross connection.

The choice between 10 input voltages and 3 output voltages, as well as screw or PUSH IN connection technology, gives 60 variations for different applications.

The integrated protective circuit ensures sufficient protection in applications with resistive, as well as slightly inductive and capacitive loads. For purely inductive, capacitive or comparable loads with high switch-on and switch-off peaks, such as solenoid valves or filament lamps, ensure that the module is dimensioned appropriately or an additional safeguard is used.

e.g. electrical isolation

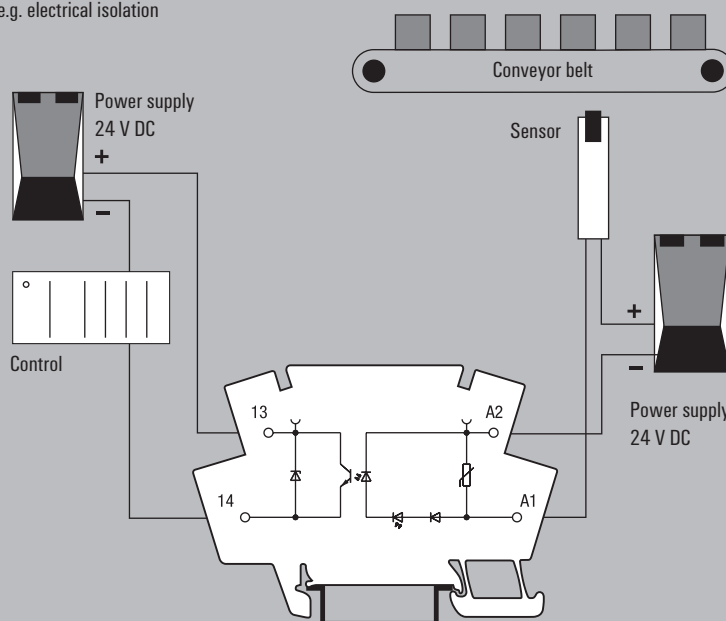

Solid-state relays, 5...48 V DC / 500 mA

Output versions

Ordering data	5 V DC	12 V DC	24 V DC	48...60 V DC	110 V DC
<b>Control side</b>					
Rated control voltage	5 V DC ±20 %	12 V DC ±20 %	24 V DC ±20 %	48...60 V DC ±20 %	110 V DC ±20 %
Nominal control current	7.7 mA DC	7.8 mA DC	7 mA DC	4.3 mA DC	2.6 mA DC
Power rating	< 40 mW	< 95 mW	≤ 170 mW	≤ 200 mW	≤ 280 mW
Cut-in / dropout voltage	4 V / 1.25 V DC	9.6 V / 3 V DC	19.2 V / 6 V DC	38.4 V / 12 V DC	88 V / 27.5 V DC
Input frequency	200 Hz	200 Hz	200 Hz	200 Hz	200 Hz
Status indicator	Green LED	Green LED	Green LED	Green LED	Green LED
Protective circuit	Varistor, rev. polarity protection	Varistor, rev. polarity protection	Varistor, rev. polarity protection	Varistor, rev. polarity protection	Varistor, rev. polarity protection
<b>Load side</b>					
Switch-on delay	< 20 µs	< 20 µs	< 20 µs	< 18 µs	< 18 µs
Switch-off delay	< 200 µs	< 200 µs	< 200 µs	< 340 µs	< 340 µs

Ordering data						
Screw connection	Type	TOS 5VDC/48VDC 0,5A	TOS 12VDC/48VDC 0,5A	TOS 24VDC/48VDC 0,5A	TOS 48-60VDC/48VDC 0,5A	TOS 110VDC/48VDC 0,5A
	Order No.	8950900000	8950910000	8950920000	8950930000	8950940000
PUSH IN connection	Type	TOP 5VDC/48VDC 0,5A	TOP 12VDC/48VDC 0,5A	TOP 24VDC/48VDC 0,5A	TOP 48-60VDC/48VDC 0,5A	TOP 110VDC/48VDC 0,5A
	Order No.	8950960000	8950970000	8950980000	8950990000	8951000000
<b>Note</b>						

Ordering data	220 V DC	24 V AC	48...60 V AC	120 V AC	230 V AC
<b>Control side</b>					
Rated control voltage	220 V DC +10 % / -15 %	24 V AC ±20%	48...60 V AC ±20 %	120 V AC ±20 %	230 V AC +10 % / -20 %
Nominal control current	1.65 mA DC	7.4 mA AC	4.3 mA AC	2.9 mA AC	1.75 mA AC
Power rating	≤ 360 mW	< 0.18 VA	≤ 0.2 VA	≤ 0.3 VA	≤ 0.4 VA
Cut-in / dropout voltage	187 V / 55 V DC	21.6 V / 9.6 V AC	38.4 V / 19.2 V AC	102 V / 48 V AC	207 V / 92 V AC
Input frequency	200 Hz	10 Hz	10 Hz	10 Hz	10 Hz
Status indicator	Green LED	Green LED	Green LED	Green LED	Green LED
Protective circuit	Varistor, rev. polarity protection	Varistor	Varistor	Varistor	Varistor
<b>Load side</b>					
Switch-on delay	< 18 µs	< 12 ms	< 12 ms	< 12 ms	< 12 ms
Switch-off delay	< 340 µs	< 14 ms	< 14 ms	< 14 ms	< 14 ms

Ordering data						
Screw connection	Type	TOS 220VDC/48VDC 0,5A	TOS 24VAC/48VDC 0,5A	TOS 48-60VAC/48VDC 0,5A	TOS 120VAC/48VDC 0,5A	TOS 230VAC/48VDC 0,5A
	Order No.	8950950000	8951020000	8951030000	8951040000	8951050000
PUSH IN connection	Type	TOP 220VDC/48VDC 0,5A	TOP 24VAC/48VDC 0,5A	TOP 48-60VAC/48VDC 0,5A	TOP 120VAC/48VDC 0,5A	TOP 230VAC/48VDC 0,5A
	Order No.	8951010000	8951060000	8951070000	8951080000	8951090000
<b>Note</b>						

**TERMOPTO – solid-state relays**

**Solid-state relays 24...230 V AC / 100 mA**

**Output versions**

- Space-saving 6.1 mm width
- Plug-in cross-connections
- Screw and PUSH IN wire connection
- Enclosed design

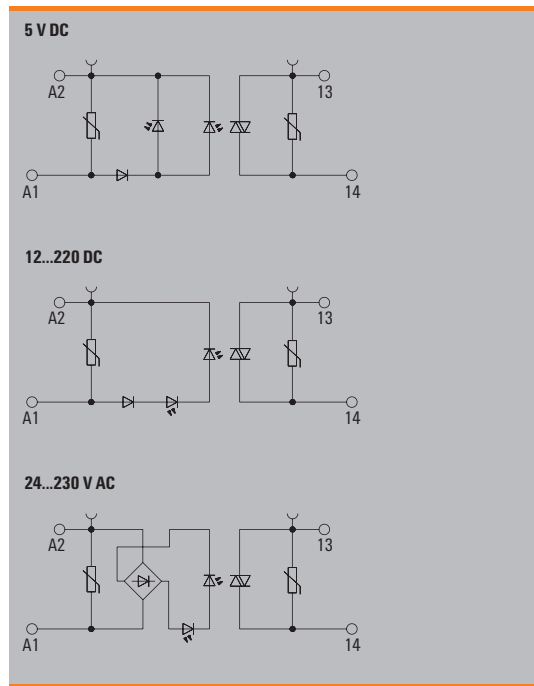
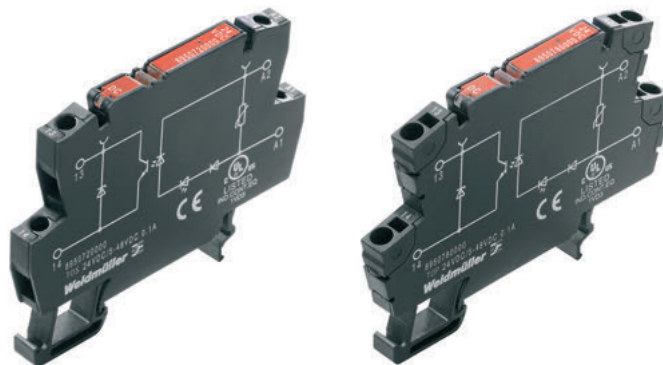

**Technical data**

Load side	
Rated switching voltage	24...230 V AC
Continuous current	100 mA
Inrush current	
Solid-state type	Triac (zero-cross switch)
Voltage drop at max. load	< 1.8 V
Leakage current	< 10 µA
Protective circuit, load side	Varistor
Short-circuit-proof / Protective circuit, load side	No / Varistor
General data	
Ambient temperature (operational)	-20 °C...60 °C
Storage temperature	-40 °C...80 °C
Humidity	5-95% rel. humidity, T <sub>v</sub> = 40°C, no condensation
Approvals	CE, cULus, EAC
Insulation coordination (EN 50178)	
Rated voltage	300 V
Impulse withstand voltage	4 kV (1.2/50 µs)
Dielectric strength for control side - load side	1.2 kV <sub>eff</sub> / 1 min.
Dielectric strength to mounting rail	
Clearance and creepage distances for control side - load side	> 3 mm
Overvoltage category	III
Pollution degree	2
Dimensions	
Clamping range (nominal / min. / max.)	mm <sup>2</sup> 2.5 / 0.5 / 2.5
Depth x width x height	mm 55 / 6.1 / 74.5
	mm 1.5 / 0.5 / 2.5
Note	
Accessories and dimensioned drawings: refer to the TERMOPTO Accessories page.	

**Applications**

The **TERMOPTO** opto module is used in industrial applications in which electrical isolation and signal conditioning without switching amplification is sufficient.

The compact design in terminal-block format saves space on the rail and offers the option of a pluggable cross connection.

The choice between 10 input voltages and 3 output voltages as well as between screw or PUSH IN connection technology gives 60 variations for different applications.

The integrated protective circuit ensures sufficient protection in applications with resistive as well as slightly inductive and capacitive loads. For purely inductive, capacitive or comparable loads with high switch-on and switch-off peaks, such as solenoid valves or filament lamps, ensure that the module is dimensioned appropriately or an additional safeguard is used.

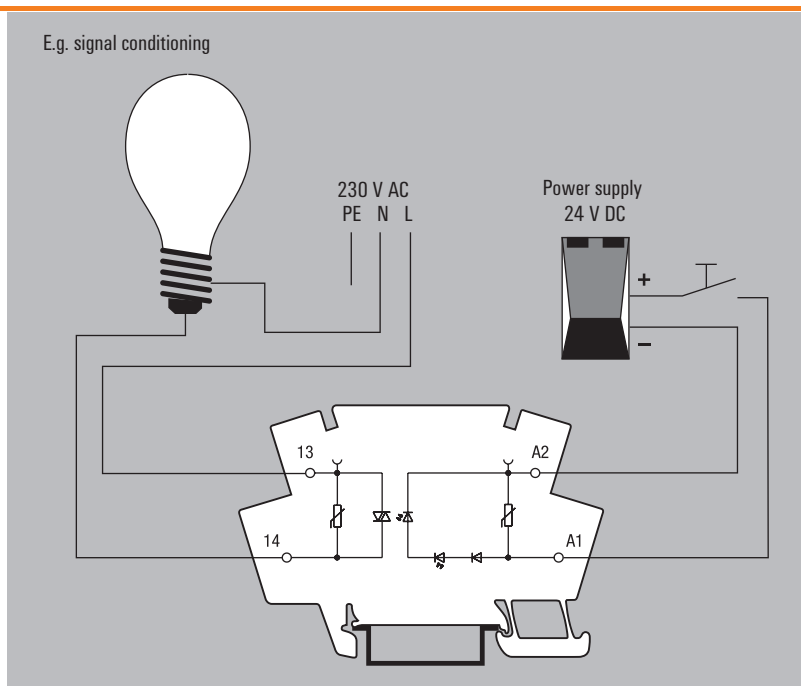

Solid-state relays 24...230 V AC / 100 mA

Output versions

Ordering data	5 V DC	12 V DC	24 V DC	48...60 V DC	110 V DC
<b>Control side</b>					
Rated control voltage	5 V DC ±20 %	12 V DC ±20 %	24 V DC ±20 %	48...60 V DC ±20 %	110 V DC ±20 %
Nominal control current	7.8 mA DC	3.6 mA DC	3.6 mA DC	3.7 mA DC	3.6 mA DC
Power rating	< 40 mW	< 45 mW	≤ 80 mW	≤ 170 mW	≤ 360 mW
Cut-in / dropout voltage	4 V / 1.25 V DC	9.6 V / 3 V DC	19.2 V / 6 V DC	38.4 V / 12 V DC	88 V / 27.5 V DC
Input frequency	10 Hz	10 Hz	10 Hz	10 Hz	10 Hz
Status indicator	Green LED	Green LED	Green LED	Green LED	Green LED
Protective circuit	Varistor, rev. polarity protection	Varistor, rev. polarity protection	Varistor, rev. polarity protection	Varistor, rev. polarity protection	Varistor, rev. polarity protection
<b>Load side</b>					
Switch-on delay	≤ 10 ms	≤ 10 ms	≤ 10 ms	≤ 10 ms	≤ 10 ms
Switch-off delay	< 12 ms	< 12 ms	< 12 ms	< 12 ms	< 12 ms

Ordering data						
Screw connection	Type	TOS 5VDC/230VAC 0,1A	TOS 12VDC/230VAC 0,1A	TOS 24VDC/230VAC 0,1A	TOS 48-60VDC/230VAC 0,1A	TOS 110VDC/230VAC 0,1A
	Order No.	8951100000	8951110000	8951120000	8951130000	8951140000
PUSH IN connection	Type	TOP 5VDC/230VAC 0,1A	TOP 12VDC/230VAC 0,1A	TOP 24VDC/230VAC 0,1A	TOP 48-60VDC/230VAC 0,1A	TOP 110VDC/230VAC 0,1A
	Order No.	8951160000	8951170000	8951180000	8951190000	8951200000
<b>Note</b>						

Ordering data	220 V DC	24 V AC	48...60 V AC	120 V AC	230 V AC
<b>Control side</b>					
Rated control voltage	220 V DC +10 % / -15 %	24 V AC ±20%	48...60 V AC ±20 %	120 V AC ±20 %	230 V AC +10 % / -20 %
Nominal control current	2.9 mA DC	8.8 mA AC	6.4 mA AC	8.5 mA AC	7.7 mA AC
Power rating	≤ 640 mW	≤ 0.2 VA	≤ 0.3 VA	≤ 1 VA	≤ 1.7 VA
Cut-in / dropout voltage	187 V / 55 V DC	19.2 V / 9.6 V AC	38.4 V / 19.2 V AC	96 V / 48 V AC	184 V / 92 V AC
Input frequency	10 Hz	10 Hz	10 Hz	10 Hz	10 Hz
Status indicator	Green LED	Green LED	Green LED	Green LED	Green LED
Protective circuit	Varistor, rev. polarity protection	Varistor	Varistor	Varistor	Varistor
<b>Load side</b>					
Switch-on delay	≤ 10 ms	< 14 ms	< 14 ms	< 22 ms	< 22 ms
Switch-off delay	< 12 ms	< 16 ms	< 16 ms	< 18 ms	< 18 ms

Ordering data						
Screw connection	Type	TOS 220VDC/230VAC 0,1A	TOS 24VAC/230VAC 0,1A	TOS 48-60VAC/230VAC 0,1A	TOS 120VAC/230VAC 0,1A	TOS 230VAC/230VAC 0,1A
	Order No.	8951150000	8951220000	8951230000	8951240000	8951250000
PUSH IN connection	Type	TOP 220VDC/230VAC 0,1A	TOP 24VAC/230VAC 0,1A	TOP 48-60VAC/230VAC 0,1A	TOP 120VAC/230VAC 0,1A	TOP 230VAC/230VAC 0,1A
	Order No.	8951210000	8951260000	8951270000	8951280000	8951290000
<b>Note</b>						



Solid-state relays, 5...48 V DC / 500 mA

Output versions with RC element

- Space-saving 6.1 mm width
- Plug-in cross-connections
- Screw and PUSH IN wire connection
- Enclosed design
- RC input circuitry for improved interference immunity

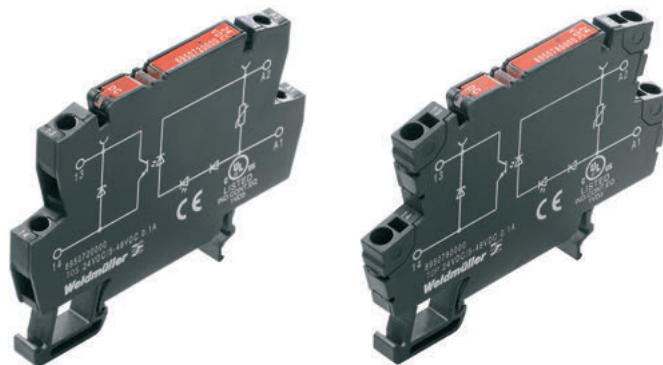

Relay modules and solid-state relays  
6 mm width

A

120 V...230 V AC

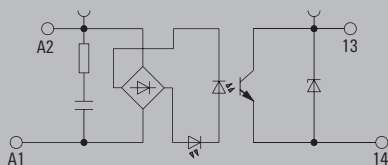

Technical data

Load side	
Rated switching voltage	5...48 V DC
Continuous current	500 mA
Inrush current	
Solid-state type	Transistor
Voltage drop at max. load	< 1 V
Leakage current	< 10 µA
Protective circuit, load side	Diode
Short-circuit-proof / Protective circuit, load side	No / Diode
General data	
Ambient temperature (operational)	-20 °C...60 °C
Storage temperature	-40 °C...80 °C
Humidity	5-95% rel. humidity, T <sub>v</sub> = 40°C, no condensation
Approvals	CE, cULus, EAC
Insulation coordination (EN 50178)	
Rated voltage	300 V
Impulse withstand voltage	4 kV (1.2/50 µs)
Dielectric strength for control side - load side	1.2 kV <sub>eff</sub> / 1 min.
Dielectric strength to mounting rail	
Clearance and creepage distances for control side - load side	> 3 mm
Overvoltage category	III
Pollution degree	2
Dimensions	
Clamping range (nominal / min. / max.)	mm <sup>2</sup> 2.5 / 0.5 / 2.5
Depth x width x height	mm 55 / 6.1 / 74.5
	mm 55 / 6.1 / 79.5
Note	
Accessories and dimensioned drawings: refer to the TERMOPTO Accessories page.	

Ordering data

Control side

Rated control voltage	120 V AC ±20 %	230 V AC +10 %/-15 %
Nominal control current	6.4 mA AC	6.4 mA AC
Power rating	≤ 0.61 VA	≤ 1.5 VA
Cut-in / dropout voltage	102 V / 48 V AC	207 V / 92 V AC

Input frequency	10 Hz	10 Hz
Status indicator	Green LED	Green LED
Protective circuit	RC element	RC element

Load side

Switch-on delay	< 12.6 ms	< 12.6 ms
Switch-off delay	< 20.8 ms	< 20.8 ms

120 V AC

230 V AC

Ordering data

Screw connection	Type	TOS 120VAC/48VDC 0.5A RC	TOS 230VAC/48VDC 0.5A RC
	Order No.	<b>1180290000</b>	<b>1189270000</b>
PUSH IN connection	Type	TOP 120VAC/48VDC 0.5A RC	TOP 230VAC/48VDC 0.5A RC
	Order No.	<b>1188830000</b>	<b>1189260000</b>

Note

**Solid-state relay, 3...33 V DC / 4 A**
**Output versions**

- Space-saving 6.1 mm width
- Plug-in cross-connections
- Screw and PUSH IN wire connection
- Enclosed design

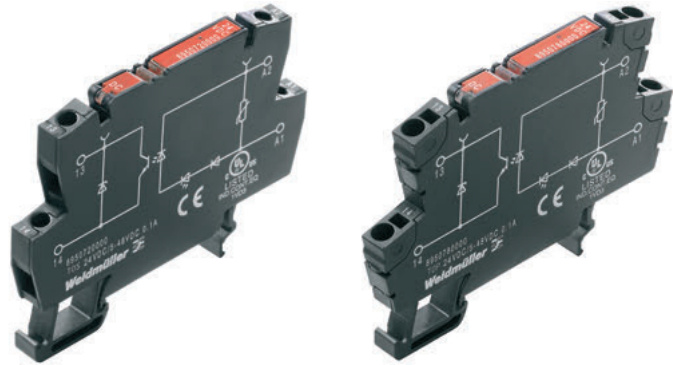
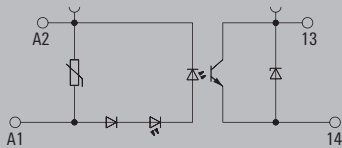
**24 V DC**

**Technical data**

Load side	
Rated switching voltage	3...33 V DC
Continuous current	4 A
Inrush current	
Solid-state type	MOS-FET
Voltage drop at max. load	90 mV
Leakage current	< 10 µA
Protective circuit, load side	Integrated free-wheel diode
Short-circuit-proof / Protective circuit, load side	No / Integrated free-wheel diode
General data	
Ambient temperature (operational)	-20 °C...60 °C
Storage temperature	-40 °C...80 °C
Humidity	5-95% rel. humidity, T <sub>v</sub> = 40°C, no condensation
Approvals	CE, cULus, EAC
Insulation coordination (EN 50178)	
Rated voltage	300 V
Impulse withstand voltage	4 kV (1.2/50 µs)
Dielectric strength for control side - load side	1.2 kV <sub>eff</sub> / 1 min.
Dielectric strength to mounting rail	
Clearance and creepage distances for control side - load side	> 3 mm
Overvoltage category	III
Pollution degree	2
Dimensions	
Clamping range (nominal / min. / max.)	mm <sup>2</sup> 2.5 / 0.5 / 2.5
Depth x width x height	mm 55 / 6.1 / 74.5
	mm 55 / 6.1 / 79.5
Note	
Accessories and dimensioned drawings: refer to the TERMOPTO Accessories page.	

**Ordering data**

Control side	
Rated control voltage	24 V DC ±20 %
Nominal control current	7 mA DC
Power rating	≤ 170 mW
Cut-in / dropout voltage	16.8 V / 6 V DC
Input frequency	10 Hz
Status indicator	Green LED
Protective circuit	Varistor, rev. polarity protection
Load side	
Switch-on delay	< 12 ms
Switch-off delay	< 14 ms

Ordering data	
Screw connection	Type TOS 24VDC/24VDC 4A
Order No.	1275100000
PUSH IN connection	Type TOP 24VDC/24VDC 4A
Order No.	1254880000

**Note**

Accessories



Plug-in cross-connection

Type	No. of poles	Qty.	Order No.
<b>yellow</b>			
ZQV 4N / 2 GE	2	60	1758250000
ZQV 4N / 3 GE	3	60	1762630000
ZQV 4N / 4 GE	4	60	1762620000
ZQV 4N / 10 GE	10	20	1758260000
ZQV 4N / 20 GE	20	20	1909020000
<b>red</b>			
ZQV 4N / 2 RT	2	60	1793950000
ZQV 4N / 3 RT	3	60	1793980000
ZQV 4N / 4 RT	4	60	1794010000
ZQV 4N / 10 RT	10	20	1794040000
ZQV 4N / 20 RT	20	20	1909150000
<b>blue</b>			
ZQV 4N / 2 BL	2	60	1793960000
ZQV 4N / 3 BL	3	60	1793990000
ZQV 4N / 4 BL	4	60	1794020000
ZQV 4N / 10 BL	10	20	1794050000
ZQV 4N / 20 BL	20	20	1909100000
<b>black</b>			
ZQV 4N / 2 SW	2	60	1793970000
ZQV 4N / 3 SW	3	60	1794000000
ZQV 4N / 4 SW	4	60	1794030000
ZQV 4N / 10 SW	10	20	1794060000
ZQV 4N / 20 SW	20	20	1909120000

Other accessories

Type	Qty.	Order No.	
<b>Markers</b>			
WS 12/6	12 x 6 mm	600	1609900000
<b>Screwdriver</b>			
SD 0.6 x 3.5 x 100		10	9008330000

Screwdriver - blade shape

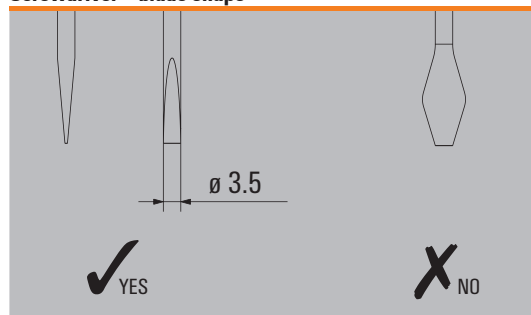

General data - TERMOPTO

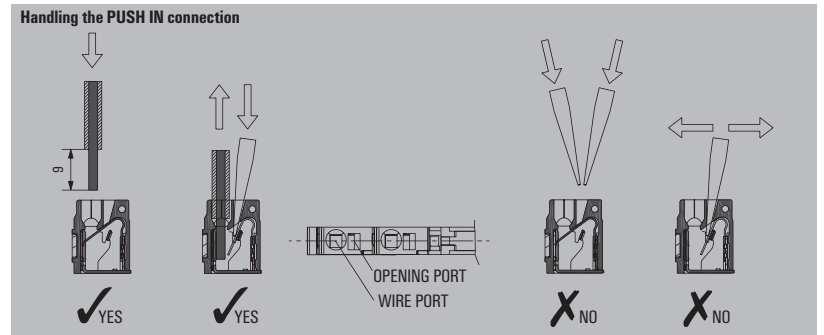

Technical data

Conductor		PUSH IN connection	Screw-connection
Solid H07V-U	mm <sup>2</sup>	0.5...1.5	0.5...2.5
Stranded H07V-K	mm <sup>2</sup>	0.5...1.5	0.5...2.5
"f" with wire end ferrules to DIN 46228-1	mm <sup>2</sup>	0.5...1.5	0.5...1.5
"f" with wire end ferrules with plastic collar	mm <sup>2</sup>	0.5...1.5	0.5...1.5
Max. clamping range	mm <sup>2</sup>	0.13...1.5	0.13...2.5
Plug gauge to IEC 60947-1	Size	A 2	A 3
<b>General technical data</b>			
Nominal torque	Nm	-	0.6
Continuous current for 2-pole cross-connection	A	10	10
Continuous current for multi-pole cross-connection	A	10	10
Stripping length	mm	10	9
Ingress protection class		IP 20	IP 20
Housing material		Wemid	Wemid
UL94 flammability rating		V-0	V-0
Nominal current	A	6	6
Nominal voltage	V	250	250

Dimensions

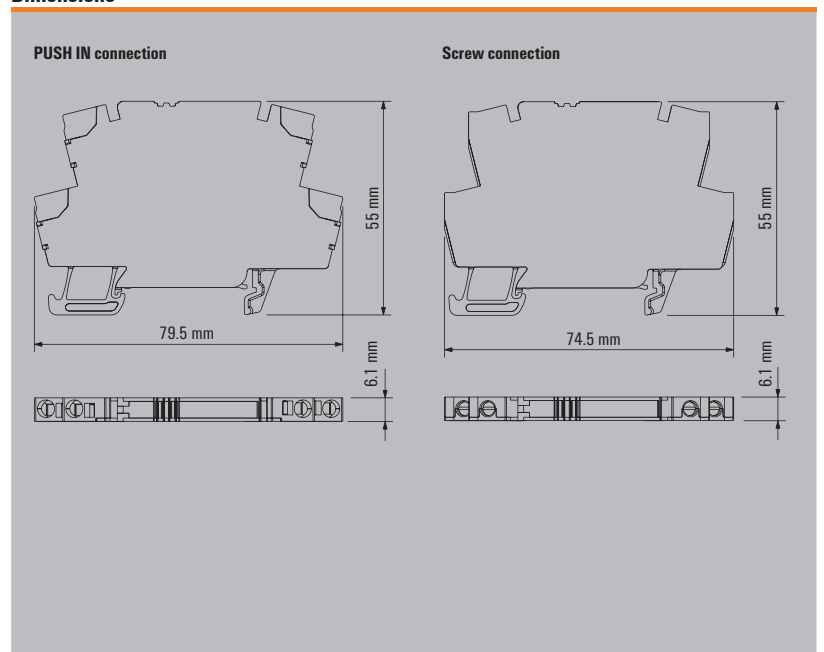



# Short-circuit-proof switching amplifier for inductive loads up to 10 A

## Powerful, compact solid-state relay with error signalling contact

The MICROOPTO family offers the customer high-quality optos and solid-state relays for application-oriented problem solutions. All products are designed in the space-saving 6 mm terminal size. The new solid-state relay can be connected in the output circuits of control systems and feedback control modules for selective activation of inductive loads up to 24 V DC / 10 A, such as solenoid valves, contactors etc. The error controlled output monitors short-circuits and, if necessary, switched off; a potential-free signalling contact provides feedback to the control system – the system can be shut down in a controlled manner for error rectification.

The powerful output of the MICROOPTO SOLENOID switches 10 A at 55 °C. The product can be used worldwide thanks to international approvals: CE, cULus and GL.

### Alarm function

Clear condition display through status and error LEDs in the output.



### Space-saving

Space-saving 6 mm modular width.

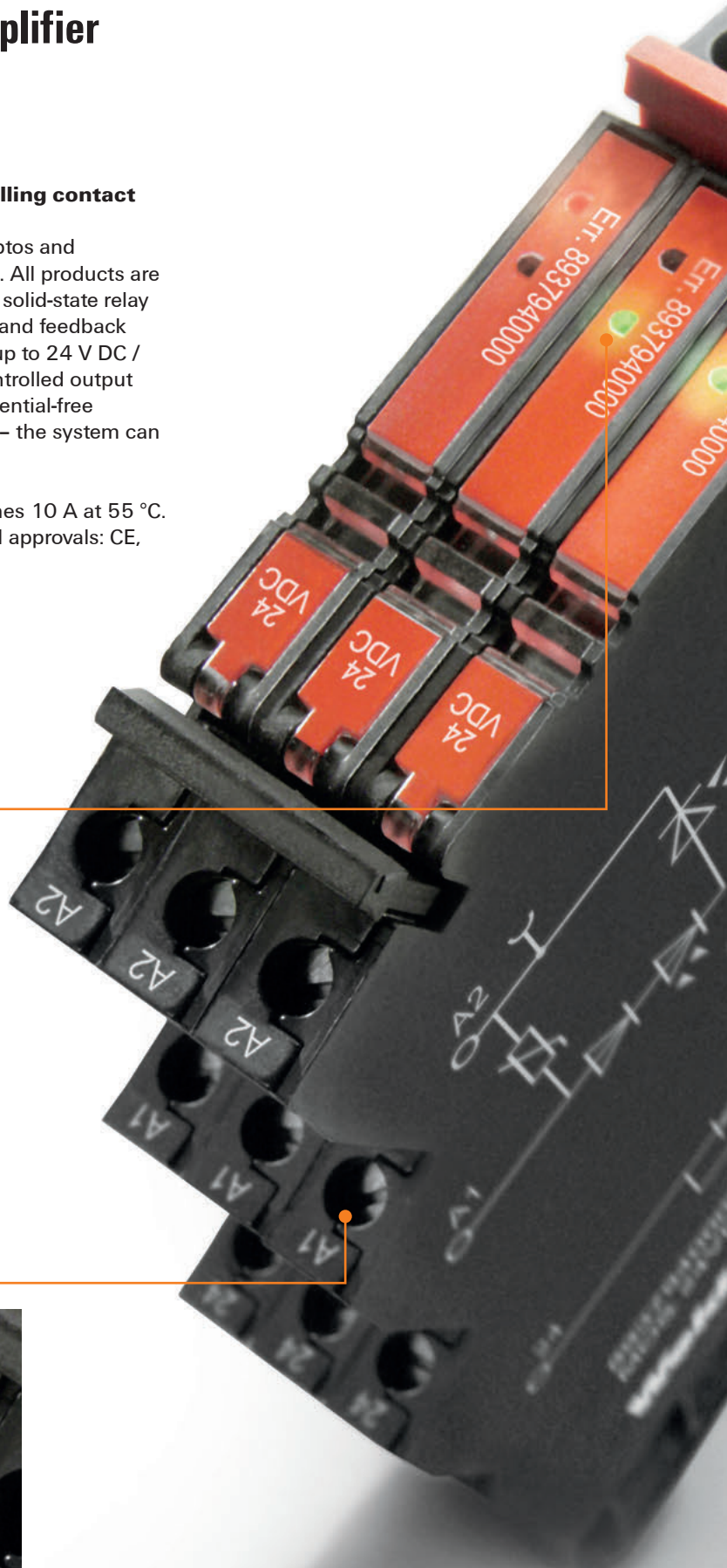





**Not sensitive**

Protected by suppressor circuit on input and output circuits.



**Tough and sturdy**

With a short-circuit-proof output.

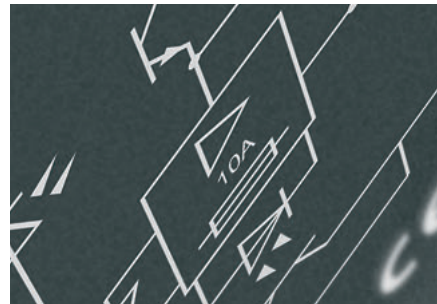

**Auxiliary contact**

An auxiliary contact issues alerts in event of short circuits.



**For switching valves up to  
24 VDC 10 A**

- Width only 6 mm
- Plug-in cross-connector
- For mounting on TS 35
- Status display and error signaling contact with an error in the output

**24 V DC / 5-33 V DC 10 A**

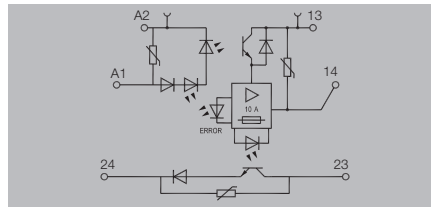

The **MICROOPTO SOLENOID** solid-state relay is used specifically as a switching amplifier for actuators up to 24 V DC and 10 A with inductive loads such as solenoid valves and contactors.

A potential-free signalling contact transmits errors, such as short circuits, to the controller.

The **MICROOPTO SOLENOID** solid-state relay is short-circuit-proof and protected against power-related transients and voltage peaks by extensive protective circuits. The closed housing also offers a high level of protection against contact.

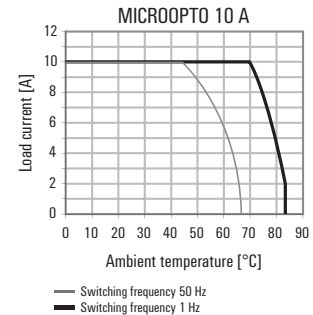

**Technical data**

**Control side**

Rated control voltage  
Power rating  
Cut-in / dropout voltage

Input frequency  
Status indicator  
Protective circuit

**Load side**

Solid-state type  
Rated switching voltage  
Continuous current  
Voltage drop at max. load  
Leakage current  
Short-circuit-proof / Protective circuit, load side

Switch-on delay / Switch-off delay  
Pulse load, max. current  
Load category

**General data**

Alarm contact  
Ambient temperature (operational)  
Storage temperature  
UL 94 flammability rating  
Humidity  
Approvals

**Insulation coordination (EN 50178)**

Rated voltage  
Impulse withstand voltage  
Dielectric strength for control side - load side  
Dielectric strength to mounting rail  
Clearance and creepage distances for control side - load side  
Overvoltage category  
Pollution degree

**Dimensions**

Clamping range (nominal / min. / max.) mm<sup>2</sup>  
Depth x width x height mm

**Note**

24 V DC ±20 %  
400 mW  
18 V / 13 V DC

50 Hz  
Error LED red; Status LED green  
Varistor, rev. polarity protection

**POWER MOS-FET**  
5...33 V DC  
10 A  
approx. 100 mV  
< 1 mA  
Yes (limited for 4 h / current limitation external < 200 A) / Current sensor, Varistor, integrated free-wheel diode  
typical. 250 µs / typical. 700 µs  
≤ 11 A (≤ 200 µs)

LC A  
5...48 V DC / 0.1 A  
-25 °C...60 °C  
-40 °C...60 °C  
V-0  
40 °C / 93 % rel. humidity, no condensation  
CE; cULus; EAC; GL

300 V  
4 kV (1.2/50 µs)  
1.2 kV<sub>eff</sub> / 1 min.  
1.2 kV<sub>eff</sub> / 1 min.  
> 3 mm  
III  
2

**Screw connection**

2.5 / 0.5 / 4  
98 / 6.1 / 88

Suppressor circuitry for inductive loads, 10 cm installation clearance to inductive switching devices.

**Ordering data**

Screw connection

Type	Qty.	Order No.
MOS 24VDC/5-33VDC 10A	1	8937940000

**Note**

**Accessories**

**Note**

Accessories and dimensioned drawings: refer to the MICROOPTO Accessories page.

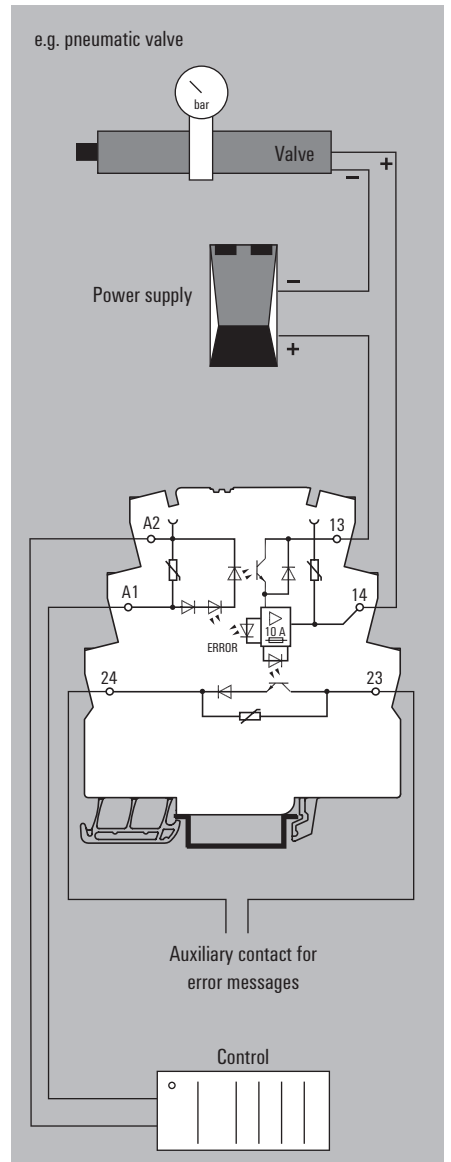

e.g. pneumatic valve

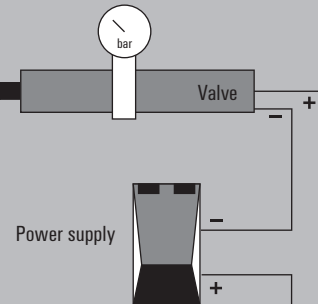

Auxiliary contact for error messages

Control

**For DC loads up to 300 V DC and 1A**

- Only 6 mm modular width
- Plug-in cross-connection
- Power Boost: 20 A / 20 ms, 5 A / 1 sec

**12...300 V DC 1 A**

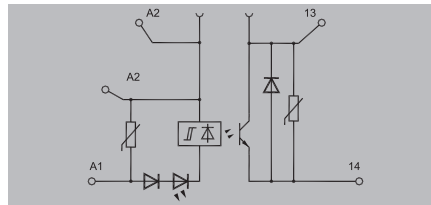

The solid-state relay **MICROOPTO 300 V DC** has been developed as a switching amplifier for high inductive loads up to 300 V DC and 1 A in motor brakes and contactors.

A power boost in the load circuit compensates transient overloads (20 A for 20 ms / 5 A for 1 s) such as making or breaking spikes. Additional protective circuits counter higher overloads.

**derating curve**

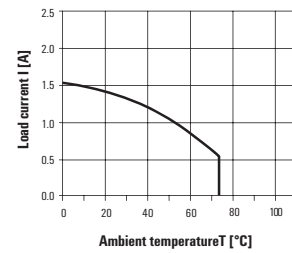

**Technical data**

Control side	
Rated control voltage	24 V DC ±20 %
Power rating	0.36 W
Cut-in / dropout voltage	18.8 V / 14.7 V DC
Input frequency	50...60 Hz
Status indicator	Green LED
Protective circuit	Varistor, rev. polarity protection
Load side	
Solid-state type	POWER MOS-FET
Rated switching voltage	12...300 V DC
Continuous current	1 A
Voltage drop at max. load	≤ 0.4 V
Leakage current	< 1 µA
Short-circuit-proof / Protective circuit, load side	No / Varistor, integrated free-wheel diode
Switch-on delay / Switch-off delay	< 18 µs / < 1 ms
Pulse load, max. current	27 A (10 ms)
Load category	LC A
General data	
Alarm contact	
Ambient temperature (operational)	-20 °C... °C
Storage temperature	-40 °C...80 °C
UL 94 flammability rating	V-0
Humidity	5-95% rel. humidity, T <sub>v</sub> = 55°C, no condensation
Approvals	CE; cULus; EAC; GL
Insulation coordination (EN 50178)	
Rated voltage	300 V
Impulse withstand voltage	2.5 kV (1.2/50 µs)
Dielectric strength for control side - load side	1.2 kV <sub>eff</sub> / 1 min.
Dielectric strength to mounting rail	1.2 kV <sub>eff</sub> / 1 min.
Clearance and creepage distances for control side - load side	> 3 mm
Overvoltage category	II
Pollution degree	2

Dimensions	
Clamping range (nominal / min. / max.)	mm <sup>2</sup>
Depth x width x height	mm
Note	
Screw connection	
2.5 / 0.5 / 4	
98 / 6.1 / 88	
Note	

**Ordering data**

Type	Qty.	Order No.
MOS 24VDC/12-300VDC 1A	1	8937830000

Type	Qty.	Order No.
MOS 24VDC/12-300VDC 1A	1	8937830000

**Accessories**

Accessories and dimensioned drawings: refer to the MICROOPTO Accessories page.

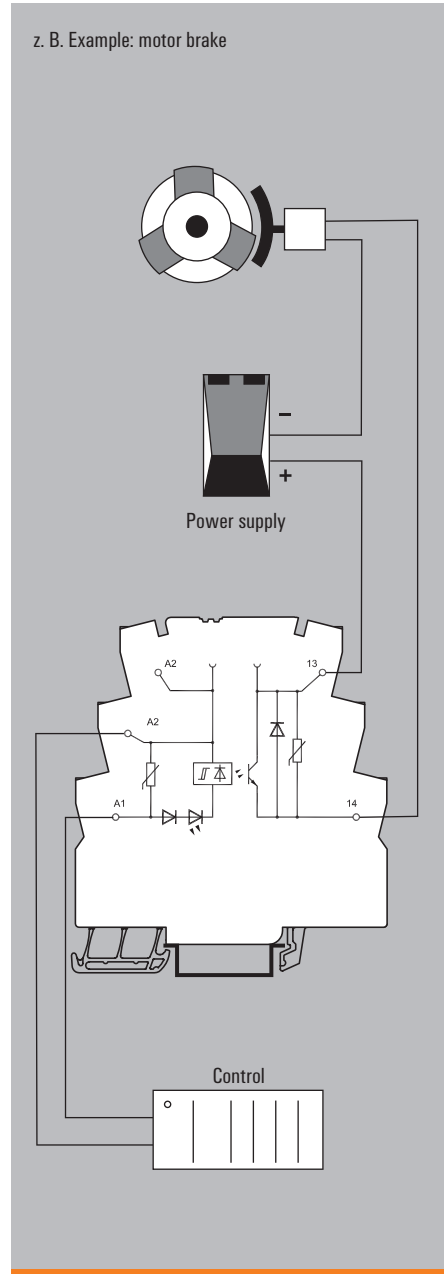

z. B. Example: motor brake



**For direct connection of actuators  
up to 24 V DC 2 A**

- Only 6 mm modular width
- Plug-in cross-connection
- PE connection direct to mounting rail
- Status display when error in output

**8...30 V DC 2 A**

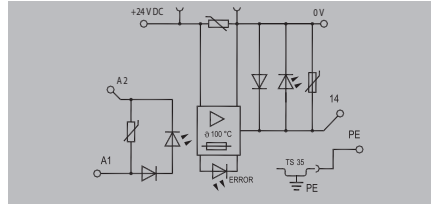

The solid-state relay **MICROOPTO ACTOR** has been specifically designed as a switching amplifier for actuators up to 24 V DC and 2 A with inductive loads such as solenoid valves and contactors. 3-wire actuators can be connected directly to the module.

This is short-circuit proof and protected against application-related transients and spikes by extensive protective circuitry.

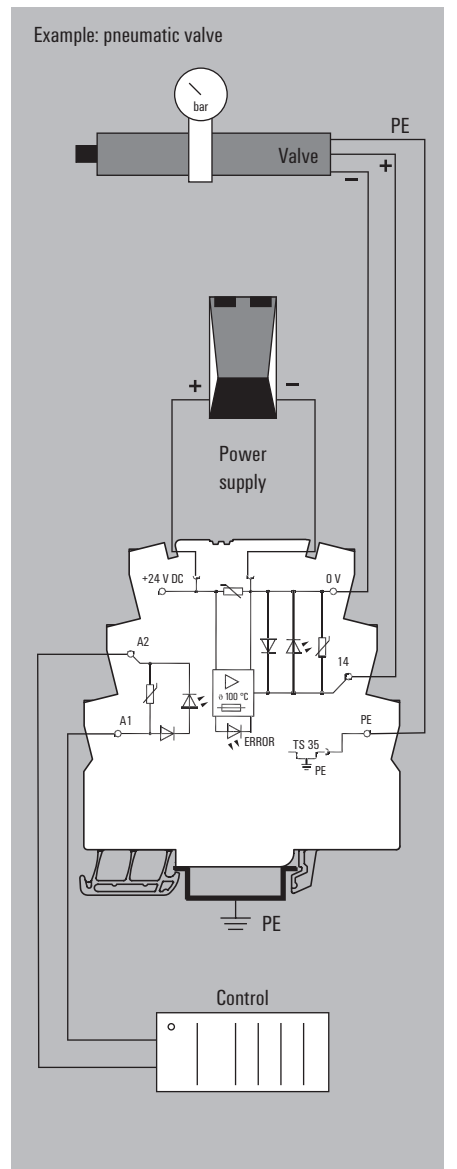
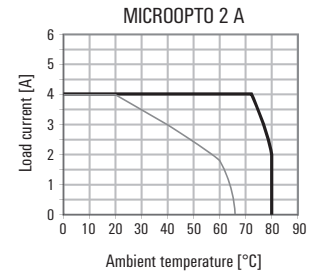

**Technical data**

**Control side**

Rated control voltage  
Power rating  
Cut-in / dropout voltage

Input frequency  
Status indicator  
Protective circuit

**Load side**

Solid-state type  
Rated switching voltage  
Continuous current  
Voltage drop at max. load  
Leakage current  
Short-circuit-proof / Protective circuit, load side

Switch-on delay / Switch-off delay  
Pulse load, max. current  
Load category

**General data**

Alarm contact  
Ambient temperature (operational)  
Storage temperature  
UL 94 flammability rating  
Humidity  
Approvals

**Insulation coordination (EN 50178)**

Rated voltage  
Impulse withstand voltage  
Dielectric strength for control side - load side  
Dielectric strength to mounting rail  
Clearance and creepage distances for control side - load side  
Overvoltage category  
Pollution degree

**Dimensions**

Clamping range (nominal / min. / max.) mm<sup>2</sup>  
Depth x width x height

**Note**

**Ordering data**

Screw connection

**Note**

**Accessories**

**Note**

24 V DC ±20 %

≤ 170 mW

13.8 V / 13.6 V DC

125 Hz

Error indication LED red; status LED green

Varistor, rev. polarity protection

Intelligent POWER MOS-FET

8...30 V DC

2 A

≤ 50 mV

< 10 µA

Yes (thermal cut-out) / Varistor, integrated free-wheel diode

0.1 ms / < 0.5 ms

LC A

-20 °C... °C

-40 °C...80 °C

V-0

5-95% rel. humidity, T<sub>v</sub> = 55°C, no condensation

CE; cULus; EAC; GL

30 V

500 V (1,2/50 µ)

350 V<sub>eff</sub> / 1 min.

350 V<sub>eff</sub> / 1 min.

II

2

**Screw connection**

2.5 / 0.5 / 4

98 / 6.1 / 88

Type	Qty.	Order No.
MOS 24VDC/8-30VDC 2A	1	8937970000

Accessories and dimensioned drawings: refer to the MICROOPTO Accessories page.

**For direct connection  
of actuators up to 24 VDC 2 A**

- Width only 6 mm
- Plug-in cross-connector
- Status display when error in output

**24 V DC / 8-30 V DC 2 A E**



The solid-state relay **MICROOPTO ACTOR** has been specifically designed as a switching amplifier for actuators up to 24 V DC and 2 A with inductive loads such as solenoid valves and contactors. 3-wire actuators can be connected directly to the module. This is short-circuit proof and protected against application-related transients and spikes by extensive protective circuitry.

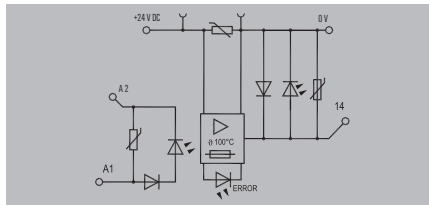

**Technical data**

Control side	
Rated control voltage	24 V DC ±20 %
Power rating	≤ 170 mW
Cut-in / dropout voltage	13.8 V / 13.6 V DC
Input frequency	10 Hz
Status indicator	Error indication LED red; status LED green
Protective circuit	Varistor, rev. polarity protection
Load side	
Solid-state type	Intelligent POWER MOS-FET
Rated switching voltage	8...30 V DC
Continuous current	2 A
Voltage drop at max. load	≤ 50 mV
Leakage current	< 10 µA
Short-circuit-proof / Protective circuit, load side	Yes (thermal cut-out) / Varistor, integrated free-wheel diode
Switch-on delay / Switch-off delay	0.1 ms / < 0.5 ms
Pulse load, max. current	LC A
Load category	
General data	
Alarm contact	
Ambient temperature (operational)	-20 °C...60 °C
Storage temperature	-40 °C...80 °C
UL 94 flammability rating	V-0
Humidity	5-95% rel. humidity, T <sub>v</sub> = 55°C, no condensation
Approvals	EAC; GL
Insulation coordination (EN 50178)	
Rated voltage	30 V
Impulse withstand voltage	500 V (1,2/50 µ)
Dielectric strength for control side - load side	350 V <sub>eff</sub> / 1 min.
Dielectric strength to mounting rail	350 V <sub>eff</sub> / 1 min.
Clearance and creepage distances for control side - load side	
Overvoltage category	II
Pollution degree	2

Screw connection		
2.5 / 0.5 / 4		
98 / 6.1 / 88		

Dimensions	
Clamping range (nominal / min. / max.)	mm <sup>2</sup>
Depth x width x height	
Note	

Type		
MOS 24VDC/8-30VDC 2A E	Qty. 10	Order No. 1283230000

**Ordering data**

Screw connection	
Note	

**Accessories**

Note	
Accessories and dimensional drawings: refer to the MICROOPTO Accessories page	

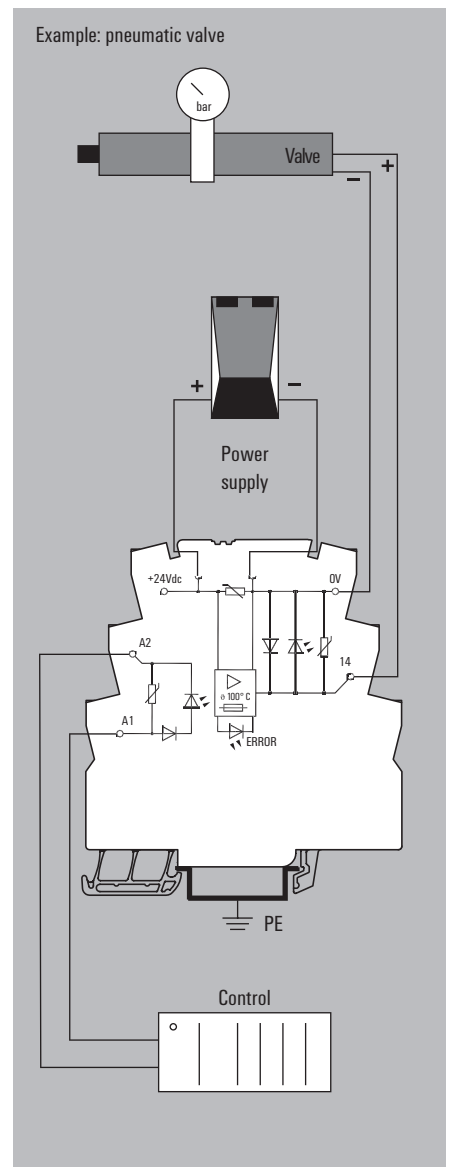

**MICROOPTO – solid-state relays**

**For electronically switching  
or inverting signals**

**24 V DC / 5-48 V DC 0.5 A**



Electronic CO contacts are used anywhere output signals need to be changed over.

For this purpose, the input signal is directly switched through to the output side and inverted; as a result, the opto module can also be used as a pure inverter.

The advantage over electromechanical relays lies in the wear-free switching and the possibility of realising high switching frequencies.

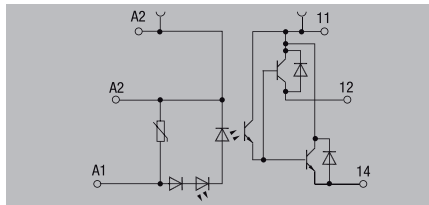

**Technical data**

Control side	
Rated control voltage	24 V DC ±20 %
Power rating	160 mW
Cut-in / dropout voltage	19.5 V / 12 V DC
Input frequency	1 kHz
Status indicator	Green status LED
Protective circuit	Varistor, rev. polarity protection
Load side	
Solid-state type	Transistor
Rated switching voltage	5...48 V DC
Continuous current	500 mA
Voltage drop at max. load	Max. 1 V
Leakage current	< 1,5 mA
Short-circuit-proof / Protective circuit, load side	No / Integrated free-wheel diode
Switch-on delay / Switch-off delay	< 30 µs / < 50 µs
Pulse load, max. current	LC A
Load category	
General data	
Alarm contact	
Ambient temperature (operational)	-25 °C...60 °C
Storage temperature	-40 °C...60 °C
UL 94 flammability rating	V-0
Humidity	40 °C / 93 % rel. humidity, no condensation
Approvals	CE; cULus; EAC; GL
Insulation coordination (EN 50178)	
Rated voltage	300 V
Impulse withstand voltage	4 kV (1.2/50 µs)
Dielectric strength for control side - load side	1.2 kV <sub>eff</sub> / 1 min.
Dielectric strength to mounting rail	1.2 kV <sub>eff</sub> / 1 min.
Clearance and creepage distances for control side - load side	> 3 mm
Overvoltage category	III
Pollution degree	2
Dimensions	
Clamping range (nominal / min. / max.)	mm <sup>2</sup>
Depth x width x height	mm
Note	

Screw connection		
Type	Qty.	Order No.
MOS 24VDC/5-48VDC 0,5A	1	8937980000

**Ordering data**

Screw connection	
Note	

**Accessories**

Accessories and dimensioned drawings: refer to the MICROOPTO Accessories page.
--

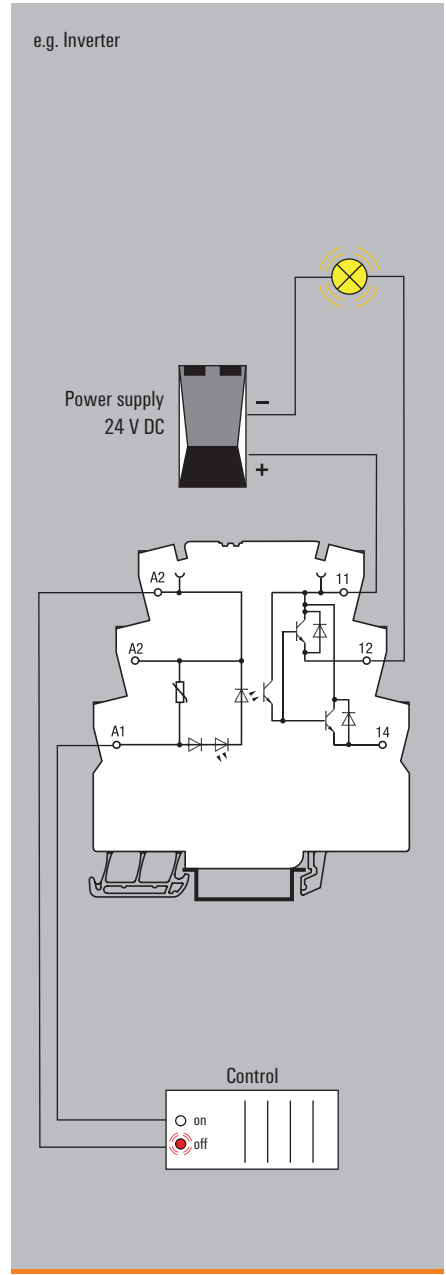

**For high switching frequency  
up to 100 kHz**

- Width only 6 mm
- Plug-in cross-connector
- For mounting on TS 35

**12...28 V DC 100 kHz**

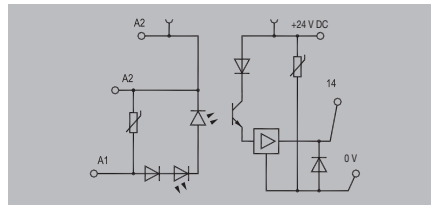

A special interior circuit in the opto module **MICROOPTO 100 kHz** ensures that rapidly transmitted signals are isolated from one another and that they can be transferred practically without delay. This allows switching frequencies up to 100 kHz to be achieved. Comprehensive suppressor circuits safeguard the module against conducted transients and voltage spikes.

**Max. switching frequency is dependent  
on the duty cycle deviation**

MOS 12-28 V DC 100 kHz (switching current 50 mA, ohmic load)

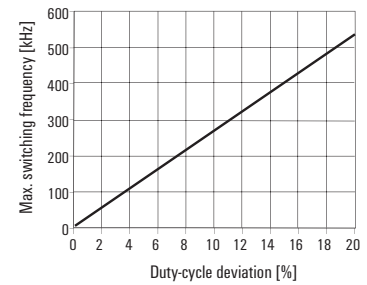

**Technical data**

**Control side**

Rated control voltage  
Power rating  
Cut-in / dropout voltage

Input frequency  
Status indicator  
Protective circuit

**Load side**

Solid-state type  
Rated switching voltage  
Continuous current  
Voltage drop at max. load  
Leakage current  
Short-circuit-proof / Protective circuit, load side

Switch-on delay / Switch-off delay  
Pulse load, max. current  
Load category

**General data**

Alarm contact  
Ambient temperature (operational)  
Storage temperature  
UL 94 flammability rating  
Humidity  
Approvals

**Insulation coordination (EN 50178)**

Rated voltage  
Impulse withstand voltage  
Dielectric strength for control side - load side  
Dielectric strength to mounting rail  
Clearance and creepage distances for control side - load side  
Overvoltage category  
Pollution degree

**Dimensions**

Clamping range (nominal / min. / max.) mm<sup>2</sup>  
Depth x width x height mm

**Note**

12 V DC...28 V DC  
≤ 280 mW  
5.6 V / 5 V DC

100 kHz  
Green LED  
Varistor, rev. polarity protection

Transistor  
19.6...28.8 V  
max. 50 mA  
≤ 2 V  
< 1 μA  
No / Varistor, rev. polarity protection

< 200 ns / < 400 ns  
0.6 A (20 ms)  
LC A

-20 °C...60 °C  
-40 °C...80 °C  
V-0  
5-95% rel. humidity, T<sub>v</sub> = 55°C, no condensation  
CE; cULus; EAC; GL

30 V  
500 V (1,2/50 μ)  
350 V<sub>eff</sub> / 1 min.  
350 V<sub>eff</sub> / 1 min.

II  
2

**Screw connection**

2.5 / 0.5 / 4  
98 / 6.1 / 88

Type	Qty.	Order No.
MOS 12-28VDC 100kHz	1	8937990000

**Ordering data**

Screw connection

**Note**

**Accessories**

**Note**

Accessories and dimensioned drawings: refer to the MICROOPTO Accessories page.

For example rotational speed measurement

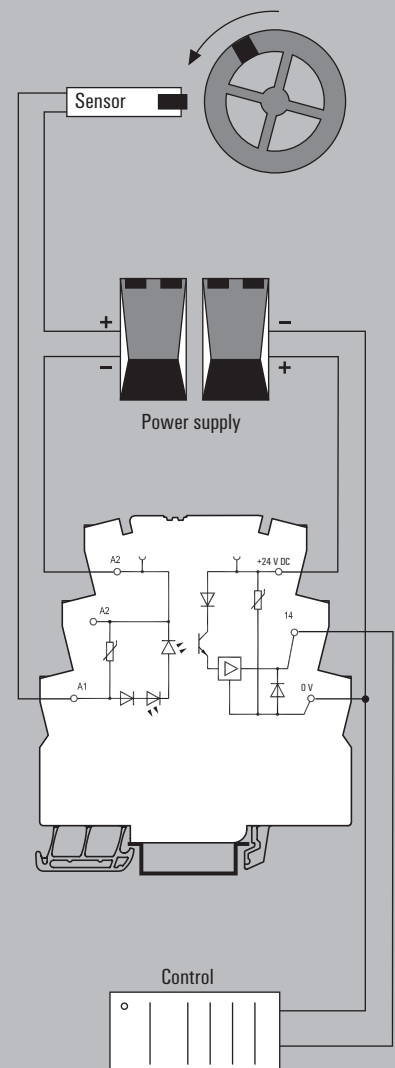

For adjusting TTL signals

5 V TTL / 24 V DC 0.1 A



To adjust sensitive TTL signals to the typical voltage level of 24 V DC used in industrial automation applications, the **MICROOPTO TTL** modules are used.

For the protection of the electronics, the sensitive TTL signals require electrical isolation from the 24 V world.

To control the optical coupler circuit via the 5 V TTL signal, an additional auxiliary voltage is fed in.

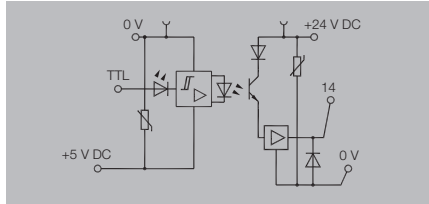

Technical data

Control side	
Rated control voltage	5 V TTL
Power rating	< 0.5 mW
Cut-in / dropout voltage	2 V / 1 V DC
Input frequency	100 kHz
Status indicator	Green status LED
Protective circuit	Varistor, rev. polarity protection
Load side	
Solid-state type	TTL
Rated switching voltage	24 VDC ±20%
Continuous current	100 mA
Voltage drop at max. load	< 1 V
Leakage current	< 20 µA
Short-circuit-proof / Protective circuit, load side	No / Integrated free-wheel diode
Switch-on delay / Switch-off delay	< 1.3 µs / < 1 µs
Pulse load, max. current	LC A
Load category	
General data	
Alarm contact	
Ambient temperature (operational)	-25 °C...60 °C
Storage temperature	-40 °C...60 °C
UL 94 flammability rating	V-0
Humidity	40 °C / 93 % rel. humidity, no condensation
Approvals	CE; cULus; EAC; GL
Insulation coordination (EN 50178)	
Rated voltage	300 V
Impulse withstand voltage	4 kV (1.2/50 µs)
Dielectric strength for control side - load side	1.2 kV <sub>eff</sub> / 1 min.
Dielectric strength to mounting rail	1.2 kV <sub>eff</sub> / 1 min.
Clearance and creepage distances for control side - load side	> 3 mm
Overvoltage category	III
Pollution degree	2
Dimensions	
Clamping range (nominal / min. / max.)	mm <sup>2</sup>
Depth x width x height	mm
Note	

Screw connection		
Type	Qty.	Order No.
MOS 5VTTL/24VDC 0,1A	1	8937920000

Ordering data

Screw connection	
Note	

Accessories

Note	
Accessories and dimensioned drawings: refer to the MICROOPTO Accessories page.	

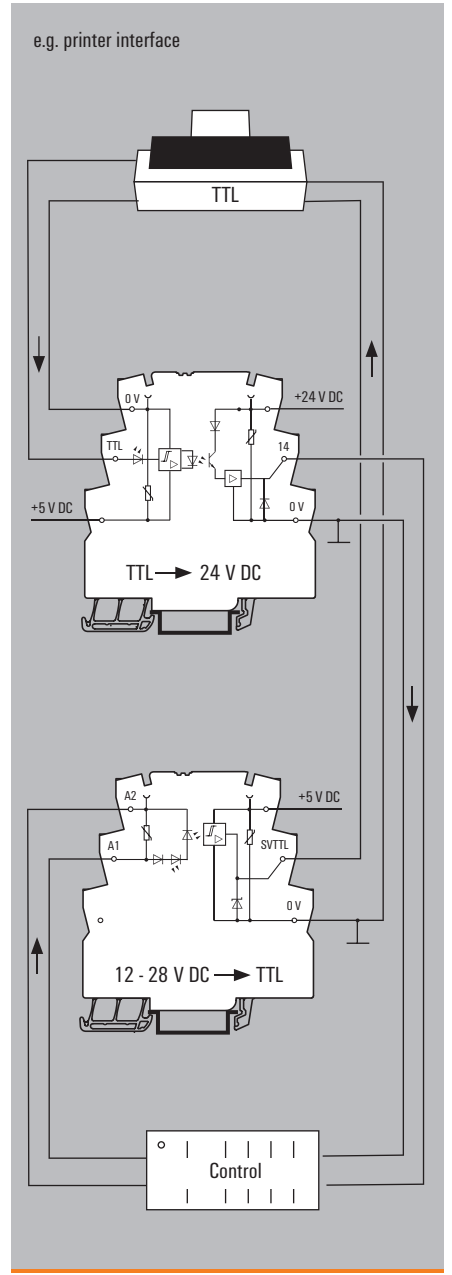

For adjusting TTL signals

12-28 V DC / 5 V TTL



To adjust sensitive TTL signals to the typical voltage level of 24 V DC used in industrial automation applications, the MICROOPTO TTL modules are used.

For the protection of the electronics, the sensitive TTL signals require electrical isolation from the 24 V world.

To control the optical coupler circuit via the 5 V TTL signal, an additional auxiliary voltage is fed in.

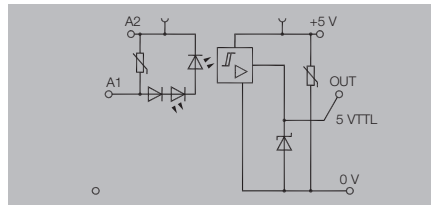

Technical data

Control side	
Rated control voltage	12 V DC..28 V DC
Power rating	150 mW
Cut-in / dropout voltage	10.7 V / 10.6 V DC
Input frequency	100 kHz
Status indicator	Green status LED
Protective circuit	Varistor, rev. polarity protection
Load side	
Solid-state type	TTL
Rated switching voltage	5 V TTL
Continuous current	max. 50 mA
Voltage drop at max. load	90 mV
Leakage current	< 1 µA
Short-circuit-proof / Protective circuit, load side	No / Varistor
Switch-on delay / Switch-off delay	typical. < 1 µs / typical. < 4 µs
Pulse load, max. current	LC A
Load category	
General data	
Alarm contact	
Ambient temperature (operational)	-25 °C..60 °C
Storage temperature	-40 °C..60 °C
UL 94 flammability rating	V-0
Humidity	40 °C / 93 % rel. humidity, no condensation
Approvals	CE; cULus; EAC; GL
Insulation coordination (EN 50178)	
Rated voltage	300 V
Impulse withstand voltage	4 kV (1.2/50 µs)
Dielectric strength for control side - load side	1.2 kV <sub>eff</sub> / 1 min.
Dielectric strength to mounting rail	1.2 kV <sub>eff</sub> / 1 min.
Clearance and creepage distances for control side - load side	> 3 mm
Overvoltage category	III
Pollution degree	2
Dimensions	
Clamping range (nominal / min. / max.)	mm <sup>2</sup>
Depth x width x height	mm
Note	

Screw connection		
Type	Qty.	Order No.
MOS 12-28VDC/5VTTL	1	8937930000

Ordering data

Screw connection	
Note	

Accessories

Note	
Accessories and dimensioned drawings: refer to the MICROOPTO Accessories page.	

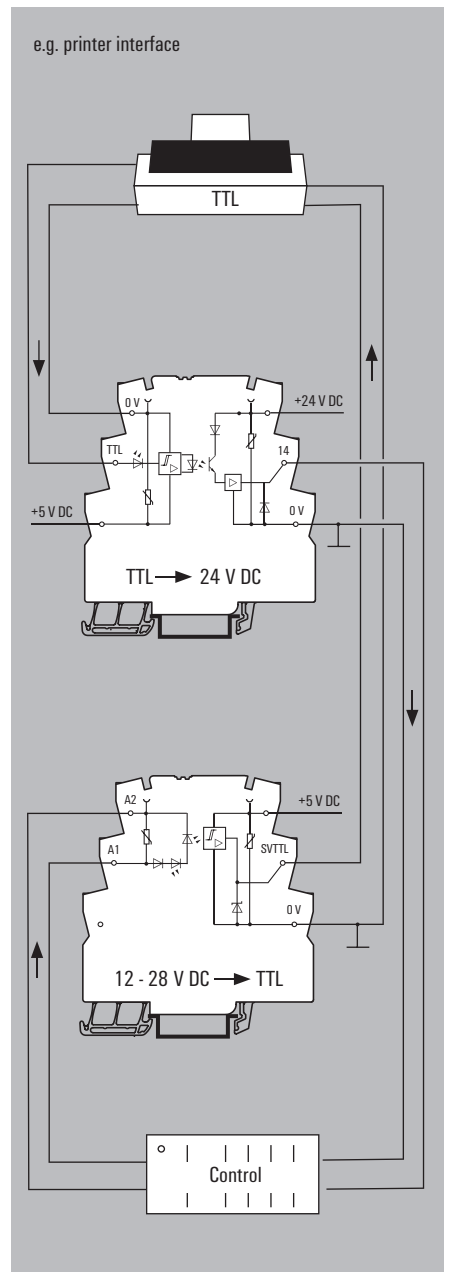

Accessories

General data – MICROOPTO

Relay modules and solid-state relays in 6 mm width

A



Plug-in cross-connection

Type	No. of poles	Qty.	Order No.
<b>yellow</b>			
ZQV 4N / 2 GE	2	60	1758250000
ZQV 4N / 3 GE	3	60	1762630000
ZQV 4N / 4 GE	4	60	1762620000
ZQV 4N / 10 GE	10	20	1758260000
ZQV 4N / 20 GE	20	20	1909020000
<b>red</b>			
ZQV 4N / 2 RT	2	60	1793950000
ZQV 4N / 3 RT	3	60	1793980000
ZQV 4N / 4 RT	4	60	1794010000
ZQV 4N / 10 RT	10	20	1794040000
ZQV 4N / 20 RT	20	20	1909150000
<b>blue</b>			
ZQV 4N / 2 BL	2	60	1793960000
ZQV 4N / 3 BL	3	60	1793990000
ZQV 4N / 4 BL	4	60	1794020000
ZQV 4N / 10 BL	10	20	1794050000
ZQV 4N / 20 BL	20	20	1909100000
<b>black</b>			
ZQV 4N / 2 SW	2	60	1793970000
ZQV 4N / 3 SW	3	60	1794000000
ZQV 4N / 4 SW	4	60	1794030000
ZQV 4N / 10 SW	10	20	1794060000
ZQV 4N / 20 SW	20	20	1909120000

Technical data

Conductor		Screw-connection
Solid H07V-U	mm <sup>2</sup>	0.5 ... 4.0
Stranded H07V-K	mm <sup>2</sup>	0.5 ... 2.5
"f" with wire end ferrules to DIN 46228-1	mm <sup>2</sup>	0.5 ... 1.5
"f" with wire end ferrules with plastic collar	mm <sup>2</sup>	0.5 ... 1.5
Max. clamping range	mm <sup>2</sup>	0.13 ... 4.0
Plug gauge to IEC 60947-1	Size	A 3
<b>General technical data</b>		
Nominal torque	Nm	0.6
Continuous current for 2-pole cross-connection	A	10
Continuous current for multi-pole cross-connection	A	10
Stripping length	mm	7
Ingress protection class		IP 20
Housing material		Wemid
UL 94 flammability rating		V-0
Nominal current	A	6
Nominal voltage	V	250

Other accessories

Type	Qty.	Order No.	
<b>Supply terminals</b>			
MOS SUPPLY	1	8973460000	
MOS FEED THROUGH	1	8973450000	
<b>Markers</b>			
WS 12/6	12 x 6 mm	600	1609900000
<b>Screwdriver</b>			
SD 0.6 x 3.5 x 100		10	9008330000
<b>Cross-connector for plugging into the clamping point</b>			
QB 75/6.2/15		10	0535200000
<b>Coloured insulating profile for QB</b>			
ISPF QB75 black		10	0526700000
ISPF QB75 blue		10	0526780000
ISPF QB75 red		10	0526760000
<b>End bracket</b>			
WEW 35/2		100	1061210000

Drawings: Supply terminals

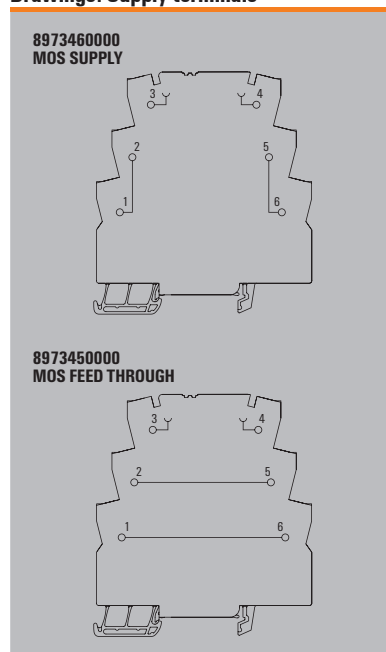

Dimensions

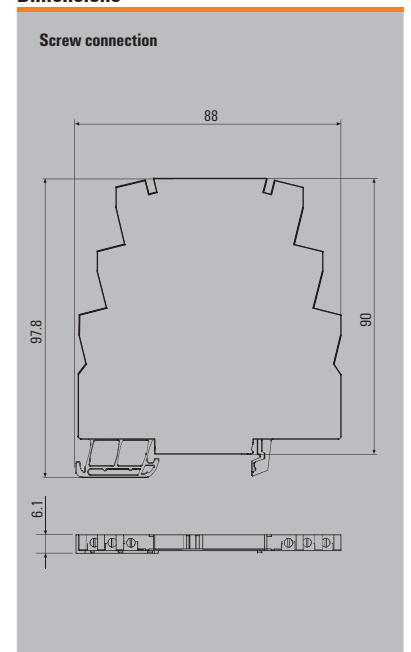





MiniConditioner MCZ R

1 CO contact AC/DC/UC coil

The module can be used as a universal interface between the controller and the actuator to switch small and medium-sized loads

- Reduced installation and commissioning costs, thanks to the use of the proven tension-spring connection system
- Pluggable cross-connection at input and output minimises the wiring workload.
- Width 6 mm
- For mounting on TS 35

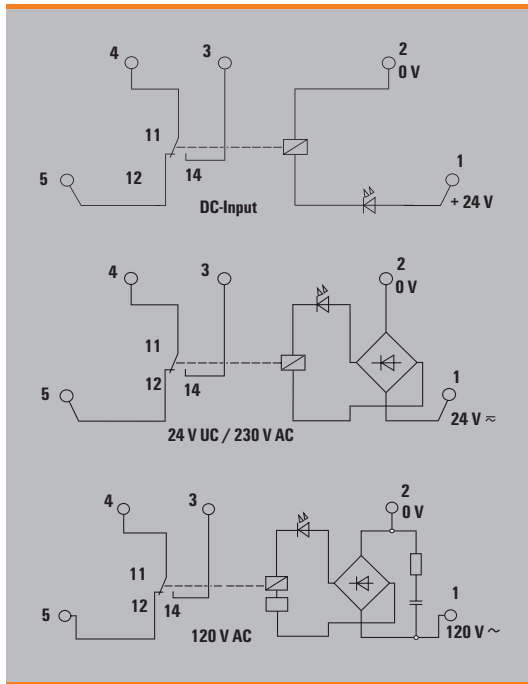
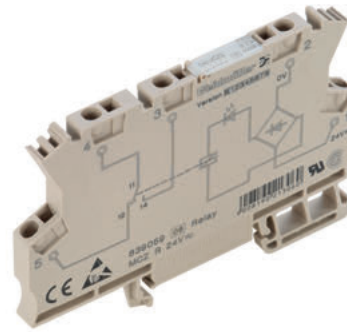

Technical data

Output	
Rated switching voltage / Continuous current	250 V AC / 6 A
Max. switching voltage, AC	250 V
Inrush current	6 A
Min. switching power	100 mA / 5 V, 10 V / 10 mA, 24 V / 1 mA
DC / AC Switching capacity (resistive), max.	144 W @ 24 V / 1500 VA
Contact material	AgSnO
Mechanical service life	10 x 10 <sup>6</sup> switching cycles
Max. switching frequency at rated load	0.1 Hz
Rated data	
Ambient temperature (operational)	-25 °C...50 °C
Storage temperature	-40 °C...60 °C
Humidity	40 °C / 93 % rel. humidity, no condensation
Approvals	CE, CSA, cURus, EAC, GL
Insulation coordination (EN 50178)	
Rated voltage	300 V
Impulse withstand voltage	4 kV (1.2/50 µs)
Dielectric strength input - output	4 kV <sub>eff</sub> / 1 s
Dielectric strength, contact / contact	
Dielectric strength to mounting rail	4 kV <sub>eff</sub> / 1 min.
Creepage and clearance distance input - output	≥ 5.5 mm
Overtoltage category	III
Pollution degree	2
Dimensions	
Clamping range (nominal / min. / max.)	mm <sup>2</sup> 1.5 / 0.5 / 2.5
Depth x width x height	mm 63.2 / 6 / 91
Note	
End plate AP MCZ 1.5: 8389030000 Accessories and dimensional drawings: refer to the MCZ Accessories page.	

Applications

Limit curve

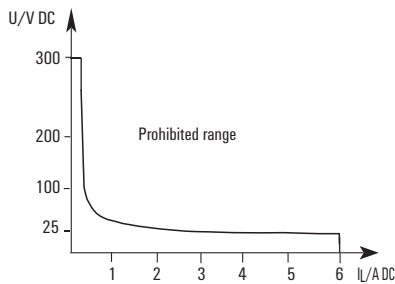

Derating curve

- in a row without spacing on terminal rail
- - - in a row with 20 mm spacing on terminal rail

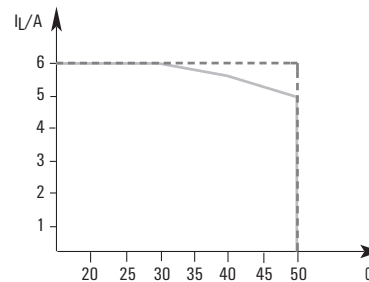

**MiniConditioner MCZ R**  
**1 CO contact AC/DC/UC coil**

<b>Ordering data</b>		<b>24 V DC 1 CO</b>	<b>24 V DC 1 CO Au</b>	<b>24 V UC 1 CO</b>	<b>110 V DC 1 CO</b>
<b>Input</b>					
Rated control voltage		24 V DC ±20 %	24 V DC ±20 %	24 V UC ±10 %	110 V DC ±10 %
Rated current AC / DC		/ 6.3 mA	/ 6.3 mA	11 mA / 6.4 mA	/ 2.85 mA
Power rating		156 mW	156 mW	160 mVA / 150 mW	340 mW
Pull-in/drop-out voltage, typ.		19 V / 4 V DC	19 V / 4 V DC	19.5 V / 3 V AC 19.5 V / 3 V DC	68 V / 19 V DC
Pull-in/drop-out current, typ.					1.6 mA / 0.6 mA DC
Status indicator		Green LED	Green LED	Green LED	Green LED
Protective circuit		Integrated free-wheel diode, Reverse polarity protection	Integrated free-wheel diode, Reverse polarity protection	Rectifier	Rectifier
<b>Load side</b>					
Switch-on delay		< 5 ms	< 5 ms	< 6 ms	< 6 ms
Switch-off delay		< 15 ms	< 15 ms	< 35 ms	< 15 ms
<b>Ordering data Complete module</b>					
CO contact	Type	MCZ R 24VDC	MCZ R 24VDC 5uAu	MCZ R 24VUC	MCZ R 110VDC
	Order No.	<b>8365980000</b>	<b>8442960000</b>	<b>8390590000</b>	<b>8467470000</b>
	Type				
	Order No.				
<b>Note</b>			Can safely switch a load of: 1...60 V AC/DC, 1...300 mA. If higher loads are switched this can damage the gold plating.		
<b>Ordering data</b>		<b>120 V AC 1 CO</b>	<b>230 V AC 1 CO</b>		
<b>Input</b>					
Rated control voltage		120 V AC -15 % / +10 %	230 V AC ±10 %		
Rated current AC / DC		7 mA /	9.5 mA /		
Power rating		0.85 VA	2.1 VA		
Pull-in/drop-out voltage, typ.		85 V / 17 V AC	150 V / 60 V AC		
Pull-in/drop-out current, typ.		4 mA / 1.3 mA AC	5 mA / 2.5 mA AC		
Status indicator		Green LED	Green LED		
Protective circuit		Rectifier	Rectifier		
<b>Load side</b>					
Switch-on delay		< 17 ms	< 11 ms		
Switch-off delay		< 35 ms	< 35 ms		
<b>Ordering data Complete module</b>					
CO contact	Type	MCZ R 120VAC	MCZ R 230VAC		
	Order No.	<b>8420880000</b>	<b>8237710000</b>		
	Type				
	Order No.				
<b>Note</b>					

**MCZ R TRAK**

**1 CO contact or 1 NO contact DC coil**

- 1 CO contact
- Component for rail industry applications
- Vibration requirements according to EN 61373, requirements category 1 class B
- Voltage fluctuations -30 %/+25 % and ±40 % for 0.1 sec
- Voltage interruptions at input up to 10 ms
- Condensation permissible

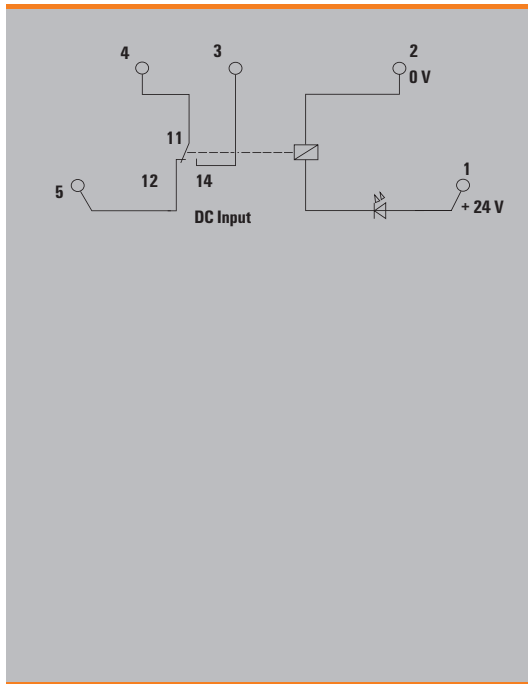
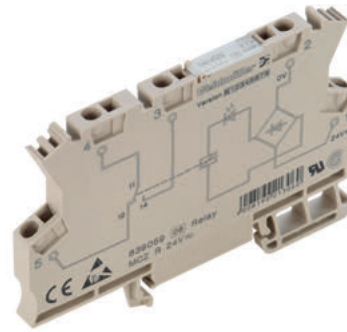

**Technical data**

Output	
Rated switching voltage / Continuous current	250 V AC / 6 A
Max. switching voltage, AC	250 V
Inrush current	6 A
Min. switching power	12 V / 100 mA
DC / AC Switching capacity (resistive), max.	120 W @ 24 V / 1500 VA
Contact material	AgSnO
Mechanical service life	10 x 10 <sup>6</sup> switching cycles
Max. switching frequency at rated load	0.1 Hz
Rated data	
Ambient temperature (operational)	-25 °C...70 °C
Storage temperature	-40 °C...85 °C
Humidity	95 % for 30 days, minimal condensation to EN 50155
Approvals	CE, EAC
Insulation coordination (EN 50178)	
Rated voltage	300 V
Impulse withstand voltage	4 kV (1.2/50 µs)
Dielectric strength input - output	4 kV <sub>eff</sub> / 1 s
Dielectric strength, contact / contact	
Dielectric strength to mounting rail	4 kV <sub>eff</sub> / 1 min.
Creepage and clearance distance input - output	≥ 5.5 mm
Overtoltage category	III
Pollution degree	2
Dimensions	
Clamping range (nominal / min. / max.)	mm <sup>2</sup> 1.5 / 0.5 / 2.5
Depth x width x height	mm 63.2 / 6 / 91
Tension clamp connection	
<b>Note</b> End plate AP MCZ 1.5: 8389030000 Accessories and dimensional drawings: refer to the MCZ Accessories page.	

**Applications**

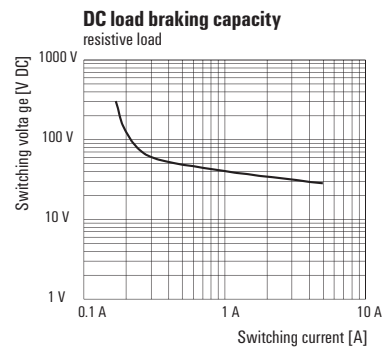
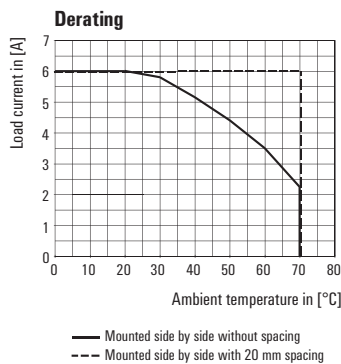

**MCZ R TRAK**

1 CO contact or 1 NO contact DC coil

<b>Ordering data</b>		<b>24 V DC TRAK</b>	<b>36 V DC TRAK</b>	<b>48...110 V DC TRAK</b>
<b>Input</b>				
Rated control voltage		24 V DC +25 % / -30 %	36 V DC +25 % / -30 %	48 V...110 V DC +25 % / -30 %
Rated current AC / DC		/ 11.5...16.5 mA	/ 8...12 mA	/ < 3 mA
Power rating		195...500 mW	200...540 mW	< 300 mW
Pull-in/drop-out voltage, typ.		14 V / 3 V DC	18 V / 4.5 V DC	25 V / 6 V DC
Pull-in/drop-out current, typ.				
Status indicator		Green LED	Green LED	Green LED
Protective circuit		Integrated free-wheel diode, Reverse polarity protection	Integrated free-wheel diode, Reverse polarity protection	Integrated free-wheel diode, Reverse polarity protection
<b>Load side</b>				
Switch-on delay		< 11 ms	< 6 ms	< 4 ms
Switch-off delay		< 50 ms	< 70 ms	< 100 ms
<b>Ordering data</b>				
<b>Complete module</b>				
CO contact	Type	MCZ R 24Vdc 1CO TRAK	MCZ R 36Vdc 1CO TRAK	MCZ R 48...110Vdc 1CO TRAK
	Order No.	<b>8713890000</b>	<b>8713900000</b>	<b>8713910000</b>
NO contact	Type	MCZ R 24Vdc 1NO TRAK		MCZ R 48...110Vdc 1NO TRAK
	Order No.	<b>8499550000</b>		<b>8574070000</b>
<b>Note</b>				

**MCZ R TRAK Au**

**1 CO contact or 1 NO contact DC coil**

- 1 CO with hard gold-plated contacts
- Component for rail industry applications
- Vibration requirements according to EN 61373, requirements category 1 class B
- Voltage fluctuations -30 %/+25 % and ±40 % for 0.1 sec
- Voltage interruptions at input up to 10 ms
- Condensation permissible

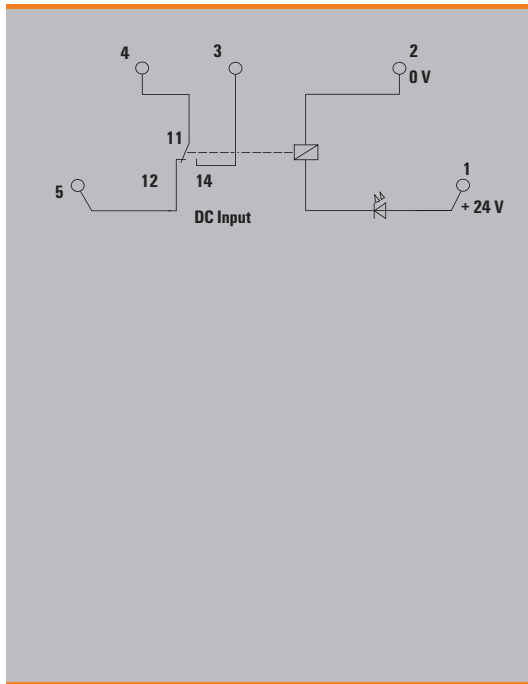
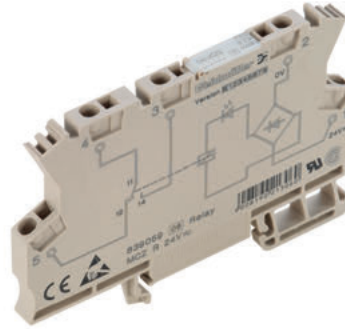

**Technical data**

Output	
Rated switching voltage / Continuous current	250 V AC / 6 A
Max. switching voltage, AC	250 V
Inrush current	6 A
Min. switching power	1 V / 1 mA
DC / AC Switching capacity (resistive), max.	120 W @ 24 V / 1500 VA
Contact material	AgSnO 5µm Au
Mechanical service life	10 x 10 <sup>8</sup> switching cycles
Max. switching frequency at rated load	0.1 Hz
Rated data	
Ambient temperature (operational)	-25 °C...70 °C
Storage temperature	-40 °C...85 °C
Humidity	95 % for 30 days, minimal condensation to EN 50155
Approvals	CE, EAC
Insulation coordination (EN 50178)	
Rated voltage	300 V
Impulse withstand voltage	4 kV (1.2/50 µs)
Dielectric strength input - output	4 kV <sub>eff</sub> / 1 s
Dielectric strength, contact / contact	
Dielectric strength to mounting rail	4 kV <sub>eff</sub> / 1 min.
Creepage and clearance distance input - output	≥ 5.5 mm
Overtoltage category	III
Pollution degree	2
Dimensions	
Clamping range (nominal / min. / max.)	mm <sup>2</sup> 1.5 / 0.5 / 2.5
Depth x width x height	mm 63.2 / 6 / 91
Note	
End plate AP MCZ 1.5: 8389030000 Accessories and dimensional drawings: refer to the MCZ Accessories page.	

**Applications**

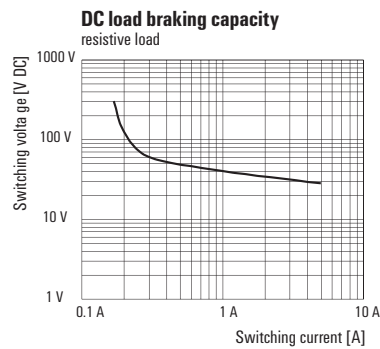
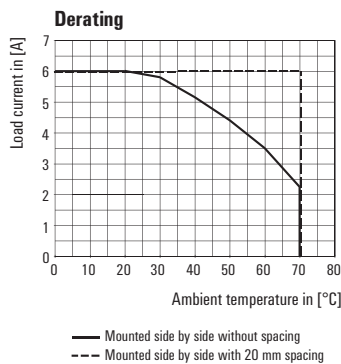

**MCZ R TRAK Au**

1 CO contact or 1 NO contact DC coil

**Ordering data**

	24 V DC TRAK Au	36 V DC TRAK Au	48...110 V DC TRAK Au
<b>Input</b>			
Rated control voltage	24 V DC +25 % / -30 %	36 V DC +25 % / -30 %	48 V...110 V DC +25 % / -30 %
Rated current AC / DC	11.5...16.5 mA	8...12 mA	< 3 mA
Power rating	195...500 mW	200...540 mW	< 300 mW
Pull-in/drop-out voltage, typ.	14 V / 3 V DC	18 V / 4.5 V DC	25 V / 6 V DC
Pull-in/drop-out current, typ.			
Status indicator	Green LED	Green LED	Green LED
Protective circuit	Integrated free-wheel diode, Reverse polarity protection	Integrated free-wheel diode, Reverse polarity protection	Integrated free-wheel diode, Reverse polarity protection
<b>Load side</b>			
Switch-on delay	< 11 ms	< 6 ms	< 4 ms
Switch-off delay	< 50 ms	< 70 ms	< 100 ms

**Ordering data**

CO contact	Type	MCZ R 24VDC 1CO AU TRAK	MCZ R 36VDC 1CO AU TRAK	MCZ R 48...110VDC 1CO AU TRAK
	Order No.	<b>8790520000</b>	<b>8790510000</b>	<b>8790500000</b>
	Type			
	Order No.			

**Note**

Can safely switch a load of: 1...60 V AC/DC, 1...300 mA. If higher loads are switched this can damage the gold plating.	Can safely switch a load of: 1...60 V AC/DC, 1...300 mA. If higher loads are switched this can damage the gold plating.	Can safely switch a load of: 1...60 V AC/DC, 1...300 mA. If higher loads are switched this can damage the gold plating.
---	---	---

**MCZ-SERIES – solid-state relays**

**MiniConditioner MCZ 0**

- Universal interface between controller and sensor/ actuator
- Tension-clamp connection system
- Plug-in cross-connection
- 6 mm modular wide

**24 V UC**

**Connection system**

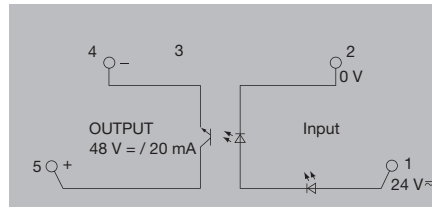
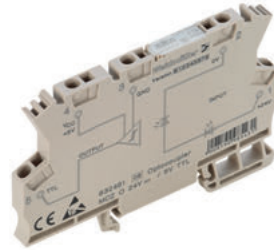

**24 V UC / 24 V 2 A**

**Connection system**

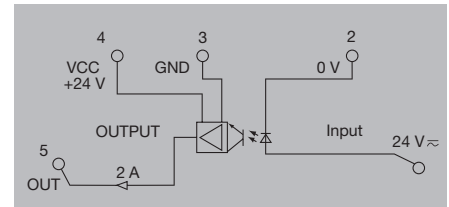
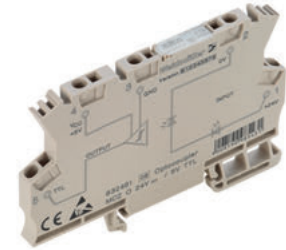

**Technical data**

Control side	
Rated control voltage	24 V UC ±20 %
Nominal control current	10 mA DC ±20 %, 10 mA AC ±20 %
Cut-in / dropout voltage	14.4 V / 13 V AC 16.8 V / 15.7 V DC
Input frequency	AC: 5 Hz / DC: 10 Hz
Power rating	230 mW / 280 mVA
Status indicator	Green LED
Protective circuit	
Load side	
Rated switching voltage	5...48 V DC
Continuous current	20 mA
Inrush current	
Solid-state type	Transistor
Voltage drop at max. load	≤ 1 V
Leakage current	
Protective circuit, load side	Integrated free-wheel diode
Short-circuit-proof	No
Switch-on delay	AC: 10 ms / DC: 20 ms
Switch-off delay	AC: 45 ms / DC: 40 ms
General data	
Ambient temperature (operational)	-25 °C...50 °C
Storage temperature	-40 °C...85 °C
Humidity	40 °C / 93 % rel. humidity, no condensation
Approvals	CE; CSA; cURus; EAC
Insulation coordination (EN 50178)	
Rated voltage	300 V
Impulse withstand voltage	6 kV (1.2/50 µs)
Dielectric strength for control side - load side	4 kV <sub>eff</sub> / 1 min.
Dielectric strength to mounting rail	4 kV <sub>eff</sub> / 1 min.
Clearance and creepage distances for control side - load side	≥ 5.5 mm
Overvoltage category	III
Pollution degree	2

Rated switching voltage	24 V UC ±20 %
Continuous current	10 mA DC ±20 %, 10 mA AC ±20 %
Inrush current	14.4 V / 13 V AC 15 V / 15 V DC
Solid-state type	AC: 10 Hz / DC: 30 Hz
Power rating	195 mW / 220 mVA
Status indicator	LED
Protective circuit, load side	
Rated switching voltage	24 VDC ±20%
Continuous current	2 A
Inrush current	
Solid-state type	Transistor
Voltage drop at max. load	≤ 1.8 V
Leakage current	
Protective circuit, load side	Varistor
Short-circuit-proof	Yes
Switch-on delay	≤ 10 ms
Switch-off delay	≤ 10 ms
Ambient temperature (operational)	-25 °C...40 °C
Storage temperature	-40 °C...60 °C
Humidity	40 °C / 93 % rel. humidity, no condensation
Approvals	CE; CSA; cURus; EAC
Rated voltage	300 V
Impulse withstand voltage	6 kV (1.2/50 µs)
Dielectric strength for control side - load side	1.2 kV <sub>eff</sub> / 5 s
Dielectric strength to mounting rail	4 kV <sub>eff</sub> / 1 min.
Clearance and creepage distances for control side - load side	≥ 5.5 mm
Overvoltage category	III
Pollution degree	2

Dimensions	
Clamping range (nominal / min. / max.)	mm <sup>2</sup>
Depth x width x height	mm
Note	

Tension clamp connection	
Clamping range (nominal / min. / max.)	mm <sup>2</sup>
Depth x width x height	mm
Note	

Tension clamp connection	
Clamping range (nominal / min. / max.)	mm <sup>2</sup>
Depth x width x height	mm
Note	

**Ordering data**

Tension-clamp connection
--------------------------

Type	Qty.	Order No.
MCZ 0 24VUC	10	8365940000

Type	Qty.	Order No.
MCZ 0 24VUC	10	8287730000

**Note**

**Accessories**

<b>Note</b>
-------------

End plate AP MCZ 1.5: 8389030000 Accessories and dimensional drawings: refer to the MCZ Accessories page.
--

End plate AP MCZ 1.5: 8389030000 Accessories and dimensional drawings: refer to the MCZ Accessories page.
--

**MiniConditioner MCZ O**

- Universal interface between controller and sensor/ actuator
- Tension-clamp connection system
- Plug-in cross-connection
- 6 mm modular wide

**120 V UC**

**Connection system**

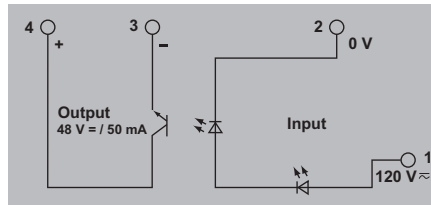
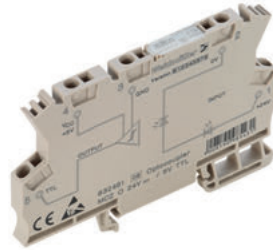

**230 V AC**

**Connection system**

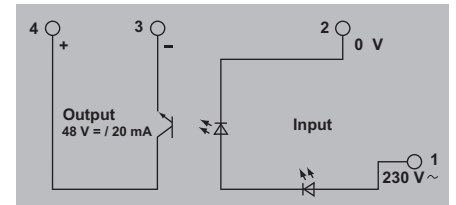
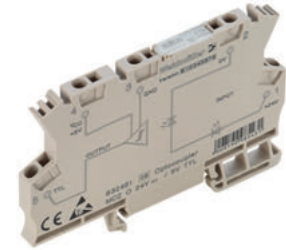

**Technical data**

Control side	
Rated control voltage	120 V UC +5 / -15 %
Nominal control current	3 mA DC (±10 %), 3 mA AC (±10 %)
Cut-in / dropout voltage	65 V / 64 V AC 70 V / 64 V DC
Input frequency	AC: 5 Hz / DC: 20 Hz
Power rating	350 mW / 400 mVA
Status indicator	Green LED
Protective circuit	
Load side	
Rated switching voltage	5...48 V DC
Continuous current	50 mA
Inrush current	
Solid-state type	Transistor
Voltage drop at max. load	1.6 V
Leakage current	≤ 1 mA
Protective circuit, load side	Integrated free-wheel diode
Short-circuit-proof	No
Switch-on delay	≤ 30 ms
Switch-off delay	≤ 40 ms
General data	
Ambient temperature (operational)	-25 °C...40 °C
Storage temperature	-40 °C...60 °C
Humidity	40 °C / 93 % rel. humidity, no condensation
Approvals	CE; CSA; cURus; EAC
Insulation coordination (EN 50178)	
Rated voltage	300 V
Impulse withstand voltage	6 kV (1.2/50 µs)
Dielectric strength for control side - load side	1.2 kV <sub>eff</sub> / 5 s
Dielectric strength to mounting rail	4 kV <sub>eff</sub> / 1 min.
Clearance and creepage distances for control side - load side	≥ 5.5 mm
Overvoltage category	III
Pollution degree	2

Rated control voltage	230 V AC +5 % / -15 %
Nominal control current	10 mA AC ±20 %
Cut-in / dropout voltage	175 V / 125 V AC
Input frequency	AC: 5 Hz duty factor 1:2
Power rating	2.3 VA
Status indicator	Green LED
Protective circuit	
Rated switching voltage	5...48 V DC
Continuous current	20 mA
Inrush current	
Solid-state type	Transistor
Voltage drop at max. load	1.6 V
Leakage current	≤ 1 mA
Protective circuit, load side	Integrated free-wheel diode
Short-circuit-proof	No
Switch-on delay	≤ 30 ms
Switch-off delay	≤ 40 ms
Ambient temperature (operational)	-25 °C...40 °C
Storage temperature	-40 °C...60 °C
Humidity	40 °C / 93 % rel. humidity, no condensation
Approvals	CE; CSA; cURus; EAC
Rated voltage	300 V
Impulse withstand voltage	6 kV (1.2/50 µs)
Dielectric strength for control side - load side	1.2 kV <sub>eff</sub> / 5 s
Dielectric strength to mounting rail	4 kV <sub>eff</sub> / 1 min.
Clearance and creepage distances for control side - load side	≥ 5.5 mm
Overvoltage category	III
Pollution degree	2

Tension clamp connection	
Clamping range (nominal / min. / max.)	1.5 / 0.5 / 1.5
Depth x width x height	63.2 / 6 / 91

**Dimensions**

Clamping range (nominal / min. / max.)	mm <sup>2</sup>
Depth x width x height	mm

**Note**

**Ordering data**

Tension-clamp connection
--------------------------

**Note**

**Accessories**

<b>Note</b>
-------------

Type	Qty.	Order No.
MCZ O 120VUC	10	8421060000

End plate AP MCZ 1.5: 8389030000 Accessories and dimensional drawings: refer to the MCZ Accessories page.
--

Type	Qty.	Order No.
MCZ O 230VAC	10	8421380000

End plate AP MCZ 1.5: 8389030000 Accessories and dimensional drawings: refer to the MCZ Accessories page.
--



**MCZ-SERIES – solid-state relays**

**MiniConditioner MCZ 0**

- Universal interface between controller and sensor/ actuator
- Tension-clamp connection system
- Plug-in cross-connection
- 6 mm modular wide

**24 V DC / 5 V TTL**

**Connection system**

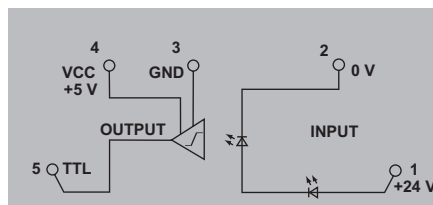
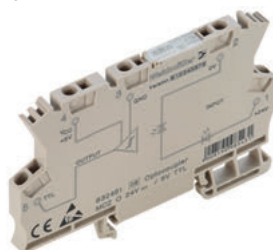

**5 V TTL / 5...48 V DC**

**Connection system**

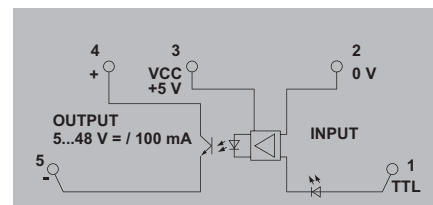
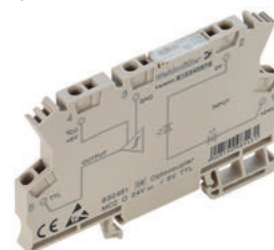

**Technical data**

Control side	
Rated control voltage	24 V DC ±16 %
Nominal control current	5 mA DC (±20 %)
Cut-in / dropout voltage	16.8 V / 16.5 V DC
Input frequency	100 kHz
Power rating	112 mW
Status indicator	Green LED
Protective circuit	
Load side	
Rated switching voltage	5 V TTL
Continuous current	8 ma, Fan out = 20 LS-TTL
Inrush current	
Solid-state type	TTL
Voltage drop at max. load	
Leakage current	
Protective circuit, load side	Diode
Short-circuit-proof	No
Switch-on delay	1 µs (at 20 V DC)
Switch-off delay	2.5 µs (at 28 V DC)
General data	
Ambient temperature (operational)	-25 °C...40 °C
Storage temperature	-40 °C...60 °C
Humidity	40 °C / 93 % rel. humidity, no condensation
Approvals	CE; CSA; cURus; EAC
Insulation coordination (EN 50178)	
Rated voltage	300 V
Impulse withstand voltage	6 kV (1.2/50 µs)
Dielectric strength for control side - load side	1.2 kV <sub>eff</sub> / 5 s
Dielectric strength to mounting rail	4 kV <sub>eff</sub> / 1 min.
Clearance and creepage distances for control side - load side	≥ 5.5 mm
Overvoltage category	III
Pollution degree	2

Rated control voltage	24 V DC ±16 %
Nominal control current	5 mA DC (±20 %)
Cut-in / dropout voltage	16.8 V / 16.5 V DC
Input frequency	100 kHz
Power rating	112 mW
Status indicator	Green LED
Protective circuit	
Rated switching voltage	5 V TTL
Continuous current	8 ma, Fan out = 20 LS-TTL
Inrush current	
Solid-state type	TTL
Voltage drop at max. load	
Leakage current	
Protective circuit, load side	Diode
Short-circuit-proof	No
Switch-on delay	1 µs (at 20 V DC)
Switch-off delay	2.5 µs (at 28 V DC)
Ambient temperature (operational)	-25 °C...40 °C
Storage temperature	-40 °C...60 °C
Humidity	40 °C / 93 % rel. humidity, no condensation
Approvals	CE; CSA; cURus; EAC
Rated voltage	300 V
Impulse withstand voltage	6 kV (1.2/50 µs)
Dielectric strength for control side - load side	1.2 kV <sub>eff</sub> / 5 s
Dielectric strength to mounting rail	4 kV <sub>eff</sub> / 1 min.
Clearance and creepage distances for control side - load side	≥ 5.5 mm
Overvoltage category	III
Pollution degree	2

Rated control voltage	5 V TTL
Nominal control current	1.65 mA DC
Cut-in / dropout voltage	
Input frequency	2.4 kHz
Power rating	10 mW
Status indicator	Green LED
Protective circuit	
Rated switching voltage	5...48 V DC
Continuous current	100 mA
Inrush current	
Solid-state type	TTL
Voltage drop at max. load	≤ 1.8 V
Leakage current	
Protective circuit, load side	Diode
Short-circuit-proof	No
Switch-on delay	< 17 µs
Switch-off delay	< 250 µs
Ambient temperature (operational)	-25 °C...40 °C
Storage temperature	-40 °C...60 °C
Humidity	40 °C / 93 % rel. humidity, no condensation
Approvals	CE; CSA; cURus; EAC
Rated voltage	300 V
Impulse withstand voltage	6 kV (1.2/50 µs)
Dielectric strength for control side - load side	1.2 kV <sub>eff</sub> / 5 s
Dielectric strength to mounting rail	4 kV <sub>eff</sub> / 1 min.
Clearance and creepage distances for control side - load side	≥ 5.5 mm
Overvoltage category	III
Pollution degree	2

**Dimensions**

Clamping range (nominal / min. / max.)	mm <sup>2</sup>
Depth x width x height	mm

**Note**

**Tension clamp connection**

1.5 / 0.5 / 1.5
63.2 / 6 / 91

**Tension clamp connection**

1.5 / 0.5 / 1.5
63.2 / 6 / 91

**Ordering data**

Tension-clamp connection
--------------------------

Type	Qty.	Order No.
MCZ 0 24VDC	10	8324610000

Type	Qty.	Order No.
MCZ 0 5VTTL	10	8398940000

**Note**

**Accessories**

Note
------

End plate AP MCZ 1.5: 8389030000 Accessories and dimensional drawings: refer to the MCZ Accessories page.
--

End plate AP MCZ 1.5: 8389030000 Accessories and dimensional drawings: refer to the MCZ Accessories page.
--

**MCZ O TRAK**

- Component for railway engineering
- Meets the requirements of EN 50155
- Voltage fluctuations of -30% / +25%
- Operating temperature: -25 °C...+70 °C (85 °C / 10 min.) acc. to EN 50155
- Condensation permissible

**24 V DC TRAK**

**Connection system**

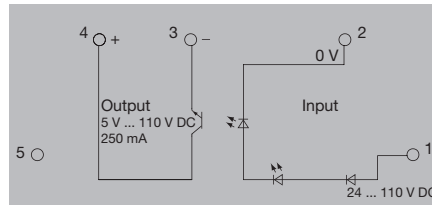
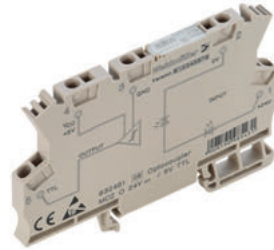

**Technical data**

**Control side**

Rated control voltage  
Nominal control current  
Cut-in / dropout voltage

24...110 V DC -30 / +25 %  
2.8 mA DC  
9.6 V / 9 V DC

Input frequency  
Power rating  
Status indicator  
Protective circuit

10 Hz  
Green LED

**Load side**

Rated switching voltage  
Continuous current  
Inrush current  
Solid-state type  
Voltage drop at max. load  
Leakage current  
Protective circuit, load side  
Short-circuit-proof  
Switch-on delay  
Switch-off delay

5...137.5 V DC  
180 mA  
Transistor  
≤ 1.7 V  
Varistor, integrated free-wheel diode  
No  
≤ 10 ms  
≤ 40 ms

**General data**

Ambient temperature (operational)  
Storage temperature  
Humidity  
Approvals

-25 °C...70 °C  
-40 °C...85 °C  
95 % for 30 days, minimal condensation to EN 50155  
CE, EAC

**Insulation coordination (EN 50178)**

Rated voltage  
Impulse withstand voltage  
Dielectric strength for control side - load side  
Dielectric strength to mounting rail  
Clearance and creepage distances for control side - load side  
Overvoltage category  
Pollution degree

300 V  
6 kV (1.2/50 µs)  
1.2 kV<sub>eff</sub> / 5 s  
4 kV<sub>eff</sub> / 1 min.  
≥ 5.5 mm  
III  
2

**Dimensions**

Clamping range (nominal / min. / max.) mm<sup>2</sup>  
Depth x width x height mm

**Tension clamp connection**

1.5 / 0.5 / 1.5  
63.2 / 6 / 91

**Note**

**Ordering data**

Tension-clamp connection

Type	Qty.	Order No.
MCZ O TRAK 24.110VDC	10	8820710000

**Note**

**Accessories**

**Note**

End plate AP MCZ 1.5: 8389030000  
Accessories and dimensional drawings: refer to the MCZ Accessories page.

MCZ accessories

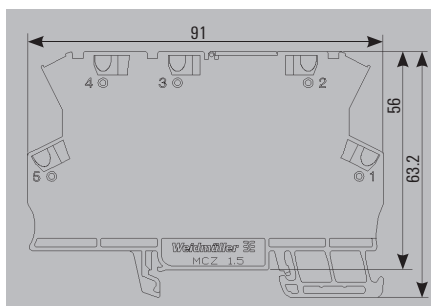

Ordering data

Type	Qty.	Order No.
End plate		

Type	Qty.	Order No.
AP MCZ 1.5	50	8389030000



Ordering data

Type	No. of poles
Plug-in cross-connection, yellow	2
Plug-in cross-connection, yellow	3
Plug-in cross-connection, yellow	4
Plug-in cross-connection, yellow	10
Plug-in cross-connection, yellow	20
Plug-in cross-connection, red	2
Plug-in cross-connection, red	3
Plug-in cross-connection, red	4
Plug-in cross-connection, red	10
Plug-in cross-connection, red	20
Plug-in cross-connection, blue	2
Plug-in cross-connection, blue	3
Plug-in cross-connection, blue	4
Plug-in cross-connection, blue	10
Plug-in cross-connection, blue	20
Plug-in cross-connection, black	2
Plug-in cross-connection, black	3
Plug-in cross-connection, black	4
Plug-in cross-connection, black	10
Plug-in cross-connection, black	20

Type	Qty.	Order No.
ZQV 4N / 2 GE	60	1758250000
ZQV 4N / 3 GE	60	1762630000
ZQV 4N / 4 GE	60	1762620000
ZQV 4N / 10 GE	20	1758260000
ZQV 4N / 20 GE	20	1909020000
<b>red</b>		
ZQV 4N / 2 RT	60	1793950000
ZQV 4N / 3 RT	60	1793980000
ZQV 4N / 4 RT	60	1794010000
ZQV 4N / 10 RT	20	1794040000
ZQV 4N / 20 RT	20	1909150000
<b>blue</b>		
ZQV 4N / 2 BL	60	1793960000
ZQV 4N / 3 BL	60	1793990000
ZQV 4N / 4 BL	60	1794020000
ZQV 4N / 10 BL	20	1794050000
ZQV 4N / 20 BL	20	1909100000
<b>black</b>		
ZQV 4N / 2 SW	60	1793970000
ZQV 4N / 3 SW	60	1794000000
ZQV 4N / 4 SW	60	1794030000
ZQV 4N / 10 SW	20	1794060000
ZQV 4N / 20 SW	20	1909120000



Ordering data

Type	Qty.	Order No.
Terminal markers		
Screwdriver		
End bracket		

Type	Qty.	Order No.
WS 10/6 MC NEUTRAL	600	1828450000
SD 0.6x3.5x100	1	9008330000
WEW 35/2	100	1061200000

# Industrial relay modules

<b>Industrial relay modules</b>	Industrial relay modules - Overview	B.2
	D-SERIES - Overview	B.4
	D-SERIES - relay modules	B.6
	RIDERSERIES - Overview	B.42
	RIDERSERIES - relay modules	B.44
	RIDERSERIES FG - Overview	B.72
	RIDERSERIES FG - relay module with positively-driven contacts	B.74

# Industrial relay module with the proven connection technology

## Easy handling and safe connections

**B** Weidmüller's relay bases are remarkable for their secure connection systems and their ease of use during wiring and installation. Pluggable cross-connection and the extra-quick PUSH IN connection help you to further reduce wiring times. In combination with the established relay technology, our industrial relay modules provide users with excellent reliability and service convenience. The wide range of relay modules provides the right solution for every industrial application.

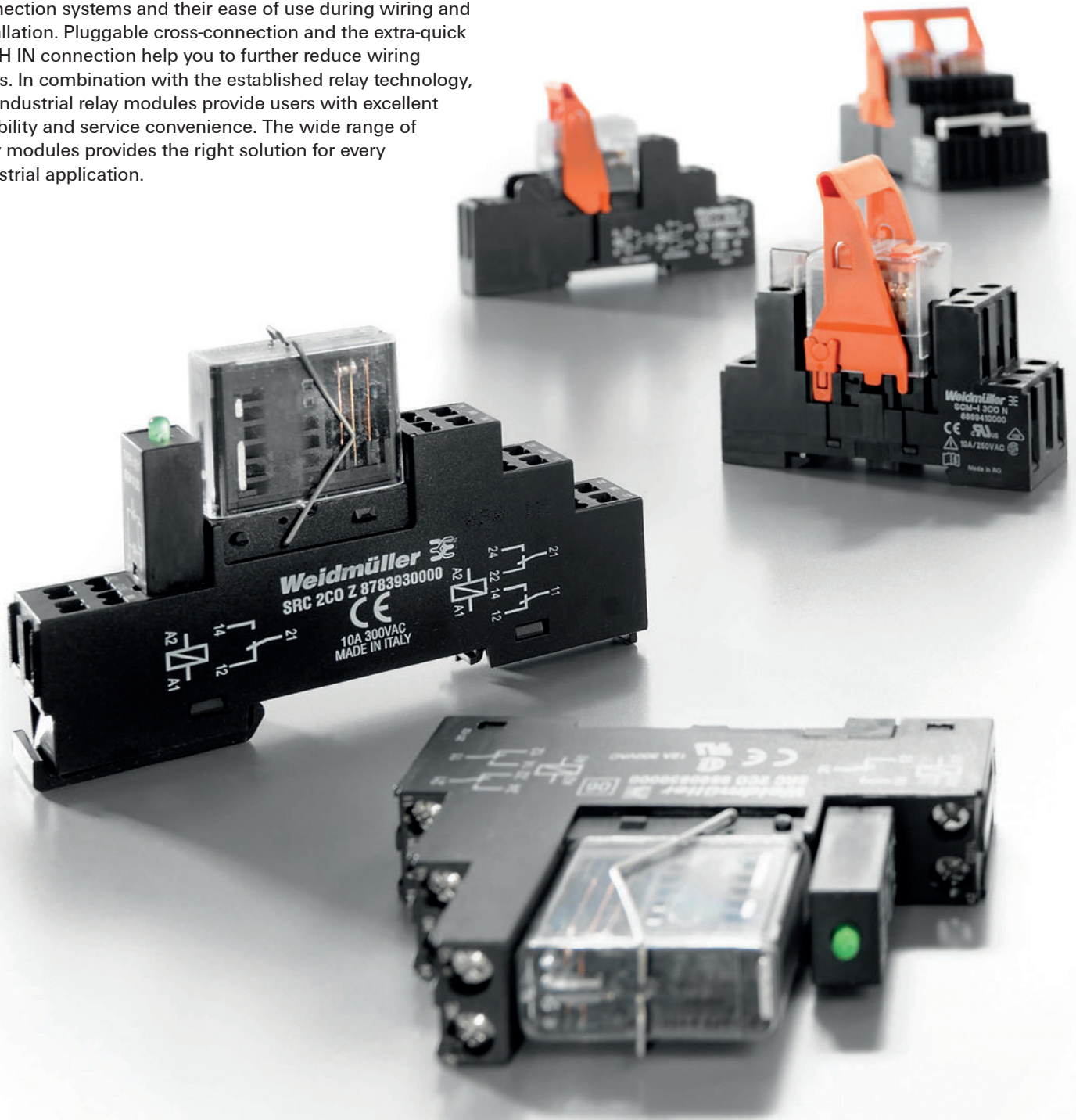

B





## A long service life is a key factor in a wide range of industrial applications

D-SERIES relay modules deliver impressively long-lasting high performance

### B

**You stringent requirements on your relay combinations in an industrial environment. Our D-SERIES relay modules were specially designed for ambitious industrial applications. Let's connect.**

In many industrial applications, voltages between 110 and 220 V are used to control actuators. Load currents greater than 100 mA cause these high voltages to create wear-intensive light arcs on the relay contacts.

We have specially designed our D-SERIES relay modules for all-purpose use in a wide range of industrial applications. They are much more reliable than conventional solutions and so help to minimise maintenance and replacement costs.

The formation of light arcs is effectively avoided with D-SERIES products thanks to contact series connection, built-in blow magnets and low-wear contacts – for a noticeably longer service life.

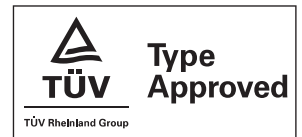

#### **Reliable at high currents and voltages**

Requirements increase where current consumption is high. D-SERIES industrial relay modules are used where high voltages and load currents impact on the actuators. For example, when motors, solenoid valves or brakes are actuated in machine construction.

**For convenient servicing**

Optional LED status indicator and test button.



**With a long service life**

The smart contact series connection and a built-in blow magnet reduce the contact erosion at loads of up to 220 V DC/10 A.

**Contacts for every application**

Thanks to various contact materials (AgNi, AgSnO, AgCdO), the products of the D-SERIES are equipped for small, medium and high loads.

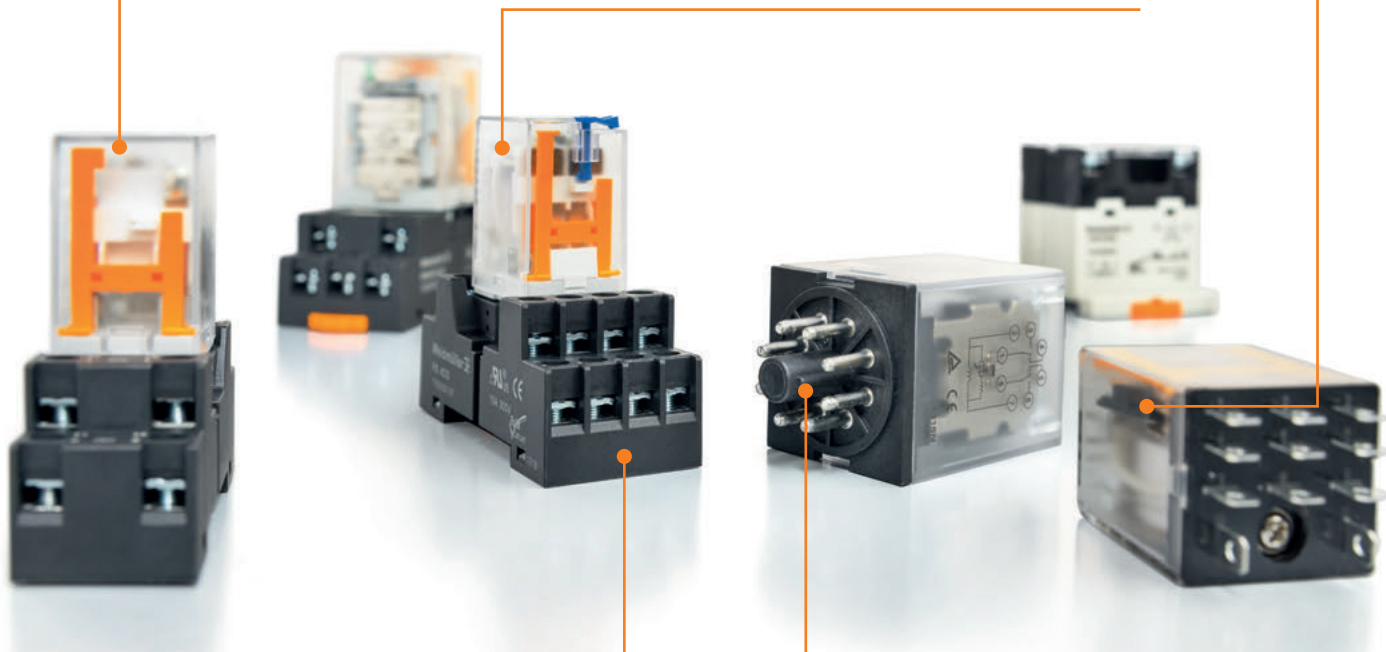

**With extensive accessories**

Flexible in use thanks to relay bases, markers and pluggable circuits (e.g. LED or free-wheel diode).



**For every control voltage**

The wide range of coil voltages from 5 V DC – 380 V AC enable them to be used on any control voltage imaginable.





**D-SERIES – relay module**

**DRM 270 relay**  
**2 CO, AC/DC coil**

- Compact design combined with high switching capacity
- Wide range of coil voltages
- Optional test button (AC red, DC blue)
- Optional status LED (AC red, DC green)
- Optional free-wheel diode



**B**

**Circuit diagram**

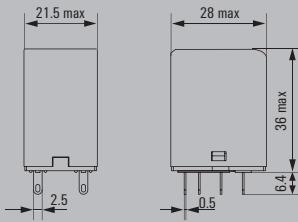
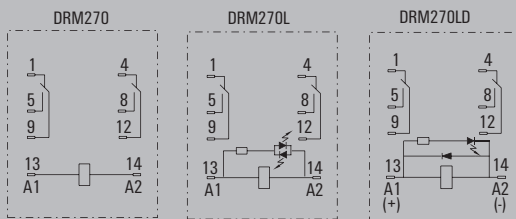

**Technical data**

Output	
Rated switching voltage / Continuous current	250 V AC / 10 A
Max. switching voltage, AC	250 V
Inrush current	
Min. switching power	12 V / 10 mA
DC / AC Switching capacity (resistive), max.	240 W @ 24 V / 2500 VA
Contact material	AgNi 0.15 gold flashed
Mechanical service life	20 x 10 <sup>6</sup> switching cycles
Max. switching frequency at rated load	0.1 Hz
Rated data	
Ambient temperature (operational)	-40 °C...60 °C
Storage temperature	-40 °C...70 °C
Humidity	35...85 % rel. humidity, no condensation
Approvals	cURus; EAC
Insulation coordination (EN 50178)	
Rated voltage	250 V
Impulse withstand voltage	6 kV (1.2/50 µs)
Dielectric strength input - output	1.8 kV <sub>eff</sub> / 1 min.
Dielectric strength, contact / contact	
Dielectric strength to mounting rail	
Creepage and clearance distance input - output	≥ 5.5 mm
Overvoltage category	III
Pollution degree	2
Dimensions	
Depth x width x height	mm 36 / 21.5 / 28
Plug-in connection	
Depth x width x height	mm 36 / 21.5 / 28
Note	

**Applications**

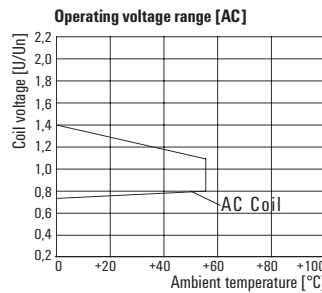
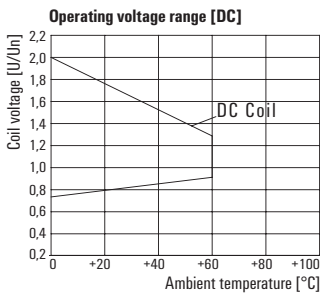
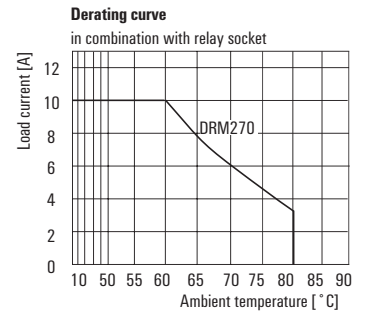
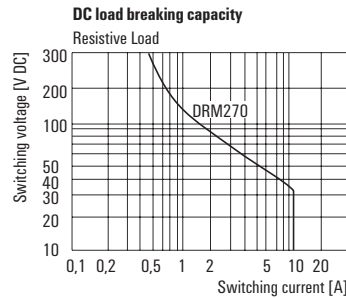
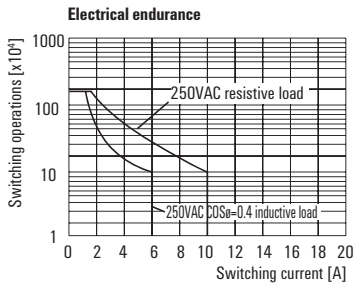

**DRM 270 relay**  
**2 CO, AC/DC coil**

<b>Type code</b>		DRM					
Type	DRM						
Type of construction	270 2 change over contact						
Coil voltage	006	6 V DC / 012	12 V DC				
	024	24 V DC / 048	48 V DC				
	110	110 V DC / 220	220 V DC				
	524	24 V AC / 548	48 V AC				
	615	115 V AC / 730	230 V AC				
LED	L (Red for AC coil; green for DC coil)						
Test lever	T (Red for AC coil; green for DC coil)						
Free-wheel diode	D						

**Ordering data**

	12 V DC 2CO	24 V DC 2CO	48 V DC 2CO	110 V DC 2CO	220 V DC 2CO
<b>Input</b>					
Rated control voltage	12 V DC	24 V DC	48 V DC	110 V DC	220 V DC
Rated current AC / DC	/ 75 mA	/ 36.9 mA	/ 18.5 mA	/ 10 mA	/ 5.2 mA
Power rating	0.9 W	0.9 W	0.9 W	1.2 W	1.2 W
Pull-in/drop-out voltage, typ.	9 V / 1.2 V DC	18 V / 2.4 V DC	36 V / 4.8 V DC	82.5 V / 11 V DC	154 V / 22 V DC
Pull-in/drop-out current, typ.					
<b>Output</b>					
Switch-on delay	< 20 ms	< 20 ms	< 20 ms	< 20 ms	< 20 ms
Switch-off delay	< 20 ms	< 20 ms	< 20 ms	< 20 ms	< 20 ms
<b>Ordering data</b>					
Standard Type	DRM270012	DRM270024	DRM270048	DRM270110	DRM270220
Order No.	<b>7760056050</b>	<b>7760056051</b>	<b>7760056052</b>	<b>7760056053</b>	<b>7760056054</b>
with LED Type	DRM270012L	DRM270024L	DRM270048L	DRM270110L	DRM270220L
Order No.	<b>7760056059</b>	<b>7760056060</b>	<b>7760056061</b>	<b>7760056062</b>	<b>7760056063</b>
With test button + LED Type	DRM270012LT	DRM270024LT	DRM270048LT	DRM270110LT	DRM270220LT
Order No.	<b>7760056068</b>	<b>7760056069</b>	<b>7760056070</b>	<b>7760056071</b>	<b>7760056072</b>
with LED Type		DRM270024LD			
+ Free-wheel diode Order No.		<b>7760056077</b>			
<b>Note</b>					

**Ordering data**

	24 V AC 2CO	48 V AC 2CO	115 V AC 2CO	230 V AC 2CO
<b>Input</b>				
Rated control voltage	24 V AC	48 V AC	115 V AC	230 V AC
Rated current AC / DC	62.4 mA (50 Hz), 52.2 mA (60 Hz) /	33.3 mA (50 Hz), 27.8 mA (60 Hz) /	12.6 mA (50 Hz), 10.8 mA (60 Hz) /	6.1 mA (50 Hz), 5.2 mA (60 Hz) /
Power rating	1.0...1.2VA (60HZ)	1.0...1.2VA (60HZ)	1.0...1.2VA (60HZ)	1.0...1.2VA (60HZ)
Pull-in/drop-out voltage, typ.	19.2 V / 7.2 V AC	38.4 V / 14.4 V AC	92 V / 34.5 V AC	184 V / 69 V AC
Pull-in/drop-out current, typ.				
<b>Output</b>				
Switch-on delay	< 20 ms	< 20 ms	< 20 ms	< 20 ms
Switch-off delay	< 20 ms	< 20 ms	< 20 ms	< 20 ms
<b>Ordering data</b>				
Standard Type	DRM270524	DRM270548	DRM270615	DRM270730
Order No.	<b>7760056055</b>	<b>7760056056</b>	<b>7760056057</b>	<b>7760056058</b>
with LED Type	DRM270524L	DRM270548L	DRM270615L	DRM270730L
Order No.	<b>7760056064</b>	<b>7760056065</b>	<b>7760056066</b>	<b>7760056067</b>
With test button + LED Type	DRM270524LT	DRM270548LT	DRM270615LT	DRM270730LT
Order No.	<b>7760056073</b>	<b>7760056074</b>	<b>7760056075</b>	<b>7760056076</b>
Type				
Order No.				
<b>Note</b>				

**D-SERIES – relay module**

**DRM 570 relay**  
**4 CO AC/DC coil**

- Compact design combined with high switching capacity
- Wide range of coil voltages
- Optional test button (AC red, DC blue)
- Optional status LED (AC red, DC green)
- Optional free-wheel diode



**Circuit diagram**

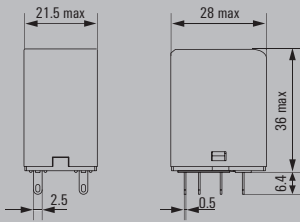
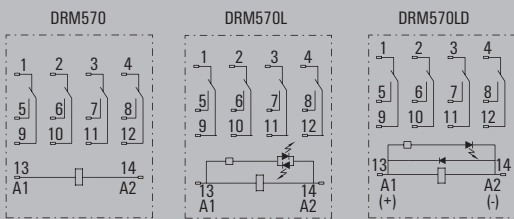

**Technical data**

Output	
Rated switching voltage / Continuous current	250 V AC / 5 A
Max. switching voltage, AC	250 V
Inrush current	
Min. switching power	12 W / 10 mA
DC / AC Switching capacity (resistive), max.	120 W @ 24 V / 1250 VA
Contact material	AgNi 0.15 gold flashed
Mechanical service life	20 x 10 <sup>6</sup> switching cycles
Max. switching frequency at rated load	0.1 Hz
Rated data	
Ambient temperature (operational)	-40 °C...60 °C
Storage temperature	-40 °C...70 °C
Humidity	35...85 % rel. humidity, no condensation
Approvals	cURus; EAC
Insulation coordination (EN 50178)	
Rated voltage	250 V
Impulse withstand voltage	6 kV (1.2/50 µs)
Dielectric strength input - output	1.8 kV <sub>eff</sub> / 1 min.
Dielectric strength, contact / contact	
Dielectric strength to mounting rail	
Creepage and clearance distance input - output	≥ 5.5 mm
Overvoltage category	III
Pollution degree	2
Dimensions	
Depth x width x height	mm 36 / 21.5 / 28
Plug-in connection	

**Note**

**Applications**

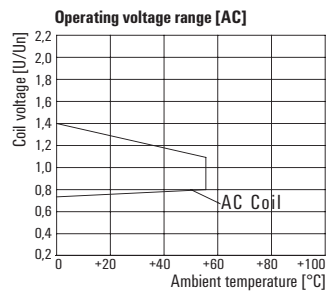
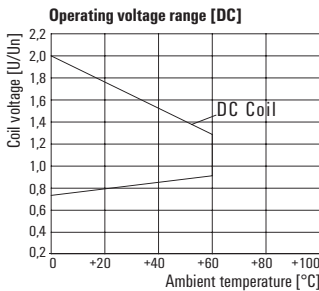
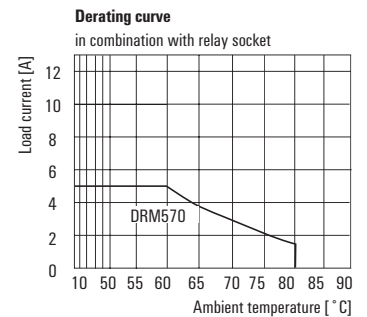
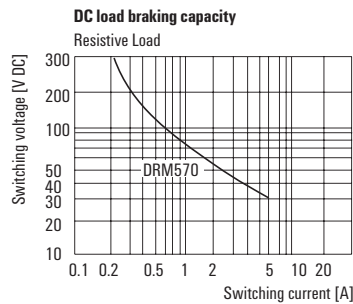
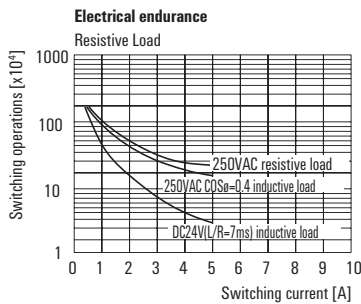

**DRM 570 relay**  
**4 CO AC/DC coil**

Type code		DRM					
Type	DRM						
Type of construction	570 4 change over contact						
Coil voltage	006	6 V DC / 012	12 V DC				
	024	24 V DC / 048	48 V DC				
	110	110 V DC / 220	220 V DC				
	524	24 V AC / 548	48 V AC				
	615	115 V AC / 730	230 V AC				
LED	L (Red for AC coil; green for DC coil)						
Test lever	T (Red for AC coil; green for DC coil)						
Free-wheel diode	D						

**Ordering data**

	12 V DC 4CO	24 V DC 4CO	48 V DC 4CO	110 V DC 4CO	220 V DC 4CO
<b>Input</b>					
Rated control voltage	12 V DC	24 V DC	48 V DC	110 V DC	220 V DC
Rated current AC / DC	/ 75 mA	/ 36.9 mA	/ 18.5 mA	/ 10 mA	/ 5.2 mA
Power rating	0.9 W	0.9 W	0.9 W	1.2 W	1.2 W
Pull-in/drop-out voltage, typ.	9 V / 1.2 V DC	18 V / 2.4 V DC	36 V / 4.8 V DC	82.5 V / 11 V DC	154 V / 22 V DC
Pull-in/drop-out current, typ.					
<b>Output</b>					
Switch-on delay	< 20 ms	< 20 ms	< 20 ms	< 20 ms	< 20 ms
Switch-off delay	< 20 ms	< 20 ms	< 20 ms	< 20 ms	< 20 ms
<b>Ordering data</b>					
Standard Type	DRM570012	DRM570024	DRM570048	DRM570110	DRM570220
Order No.	<b>7760056078</b>	<b>7760056079</b>	<b>7760056080</b>	<b>7760056081</b>	<b>7760056082</b>
with LED Type	DRM570012L	DRM570024L	DRM570048L	DRM570110L	DRM570220L
Order No.	<b>7760056087</b>	<b>7760056088</b>	<b>7760056089</b>	<b>7760056090</b>	<b>7760056091</b>
With test button + LED Type	DRM570012LT	DRM570024LT	DRM570048LT	DRM570110LT	DRM570220LT
Order No.	<b>7760056096</b>	<b>7760056097</b>	<b>7760056098</b>	<b>7760056099</b>	<b>7760056100</b>
with LED Type		DRM570024LD			
+ Free-wheel diode Order No.		<b>7760056105</b>			
<b>Note</b>					

**Ordering data**

	24 V AC 4CO	48 V AC 4CO	115 V AC 4CO	230 V AC 4CO
<b>Input</b>				
Rated control voltage	24 V AC	48 V AC	115 V AC	230 V AC
Rated current AC / DC	62.4 mA (50 Hz), 52.2 mA (60 Hz) /	33.3 mA (50 Hz), 27.8 mA (60 Hz) /	12.6 mA (50 Hz), 10.8 mA (60 Hz) /	6.1 mA (50 Hz), 5.2 mA (60 Hz) /
Power rating	1.0...1.2VA (60HZ)	1.0...1.2VA (60HZ)	1.0...1.2VA (60HZ)	1.0...1.2VA (60HZ)
Pull-in/drop-out voltage, typ.	19.2 V / 7.2 V AC	38.4 V / 14.4 V AC	92 V / 34.5 V AC	184 V / 69 V AC
Pull-in/drop-out current, typ.				
<b>Output</b>				
Switch-on delay	< 20 ms	< 20 ms	< 20 ms	< 20 ms
Switch-off delay	< 20 ms	< 20 ms	< 20 ms	< 20 ms
<b>Ordering data</b>				
Standard Type	DRM570524	DRM570548	DRM570615	DRM570730
Order No.	<b>7760056083</b>	<b>7760056084</b>	<b>7760056085</b>	<b>7760056086</b>
with LED Type	DRM570524L	DRM570548L	DRM570615L	DRM570730L
Order No.	<b>7760056092</b>	<b>7760056093</b>	<b>7760056094</b>	<b>7760056095</b>
With test button + LED Type	DRM570524LT	DRM570548LT	DRM570615LT	DRM570730LT
Order No.	<b>7760056101</b>	<b>7760056102</b>	<b>7760056103</b>	<b>7760056104</b>
Type				
Order No.				
<b>Note</b>				

## D-SERIES – DRM relays accessories

## Accessories for DRM relays



## Ordering data

Technical data		
Rated current	2CO/4CO	4 x 6 A, 2 x 12 A
Rated voltage		300 V AC
Dielectric strength for input - output		>4000 Vrms
Insulating material group (VDE 0110b)		C / 250 V AC
Ambient temperature		-40...+70 °C
Protection class		IP 20
Wire cross section / with wire end ferrule		2 x 2.5 mm <sup>2</sup> / 2 x 1.5 mm <sup>2</sup>
Max. torque		0.5 Nm / 0.8 Nm
Packing unit		10 pcs.
Description		Order No.
Socket, snaps onto DIN-rail, 2CO		7760056263
Socket, snaps onto DIN-rail, 4CO		7760056264

## Metal clip (recommended in applications with vibrations)

Type	Order No.
DRM clip M (for DRM relay)	7760056108

## Dimensions in mm

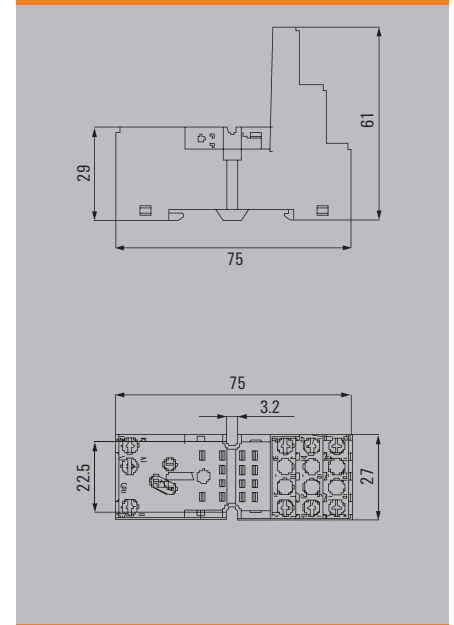

## Ordering data

Technical data			
Rated current	2CO/4CO	2 x 12 A / 4 x 10 A	
Rated voltage		300 V AC	
Dielectric strength for input - output		2500 Vrms	
Dielectric strength between the contacts		2500 Vrms	
Max. torque		0.5 Nm/0.8 Nm	
Wire cross section		0.5-2.5 mm <sup>2</sup>	
Ambient temperature (operational)		-40 °C...+70 °C	
Weight	2CO/4CO	35 g/43 g	
Packing unit		20 pcs	
Description		Qty.	Order No.
Socket, snaps onto DIN-rail, 2CO		10	7760056106
Socket, snaps onto DIN-rail, 4CO		10	7760056107

\* Functional module is not suitable for this type of sockets.

## Metal clip (recommended in applications with vibrations)

Type	Order No.
DRM clip M (for DRM relay)	7760056108

## Functional modules

Technical data	Type	Order No.
Free-wheel diode 6...230 V DC	RIM 1 6/230 V DC	7760056169
RC-combined protection 110...230 V AC	RIM 3 110/230 V AC	7760056014
RC-combined protection 110...230 V AC with LED*	RIM 3 110/230 V AC LED	7760056045
Green LED 6...24 V DC with free-wheel diode	RIM 2 6/24 V DC	7760056015
Green LED 24...60 V DC with free-wheel diode	RIM 2 24/60 V DC	7760056016
Green LED 110...230 V DC	RIM 2 110/230 V DC	7760056017
Green LED 6...24 V DC / V AC	RIM 3 6/24 V UC	7940018457
Green LED 24...60 V DC / V AC	RIM 3 24/60 V UC	7760056018
Green LED 110...230 V DC / V AC	RIM 3 110/230 V UC	7940018455

\*Not for FS sockets just for SCM sockets

## Dimensions in mm

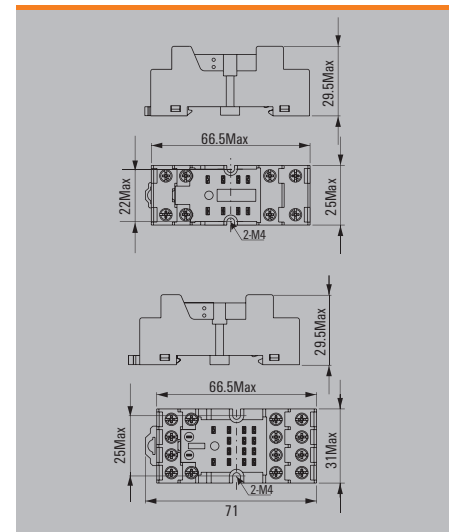

DRM clip M





**D-SERIES – relay module**

**DRL power relay**

**1 CO AC/DC coil**

- High wear resistance in case of AC loads
- High dielectric strength: 2,000 V



**B**

**Circuit diagram**

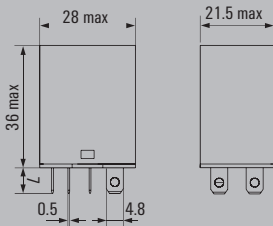
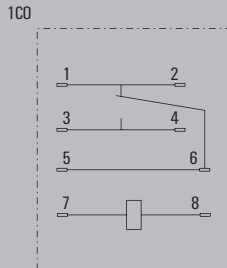

**Technical data**

Output	
Rated switching voltage / Continuous current	250 V AC / 16 A
Max. switching voltage, AC	250 V
Inrush current	
Min. switching power	12 V / 100 mA
DC / AC Switching capacity (resistive), max.	384 W @ 24 V / 4000 VA
Contact material	AgCdO
Mechanical service life	10 x 10 <sup>6</sup> switching cycles
Max. switching frequency at rated load	0.1 Hz
Rated data	
Ambient temperature (operational)	-25 °C...55 °C
Storage temperature	-25 °C...55 °C
Humidity	35 % to 85 % relative humidity level
Approvals	cURus; EAC
Insulation coordination (EN 50178)	
Rated voltage	250 V
Impulse withstand voltage	5 kV (1.2/50 µs)
Dielectric strength input - output	2 kV <sub>eff</sub> / 1 min
Dielectric strength, contact / contact	
Dielectric strength to mounting rail	
Creepage and clearance distance input - output	≥ 4 mm
Overvoltage category	III
Pollution degree	3
Dimensions	
Depth x width x height	mm 36 / 21.5 / 28
Plug-in connection	
Depth x width x height	mm 36 / 21.5 / 28

**Note**

**Applications**

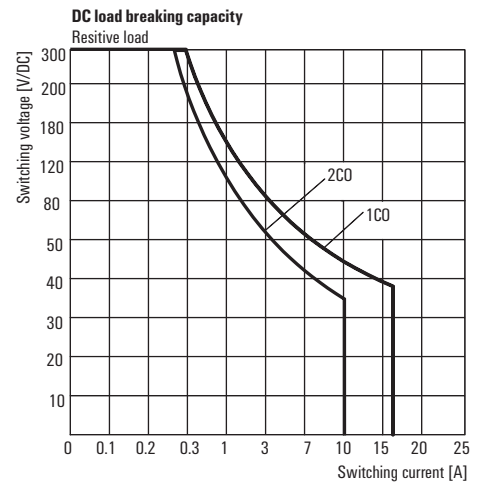
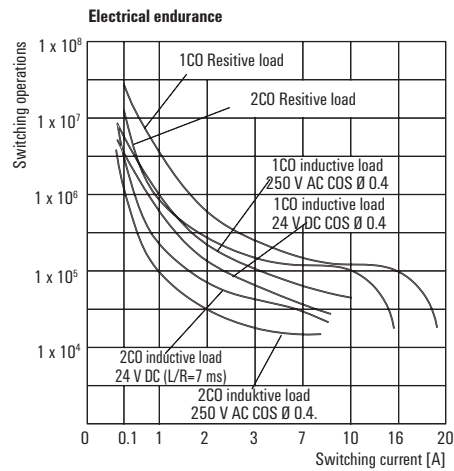
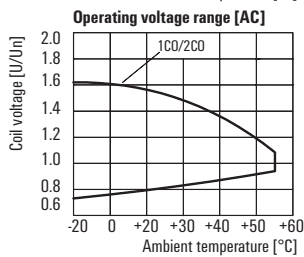
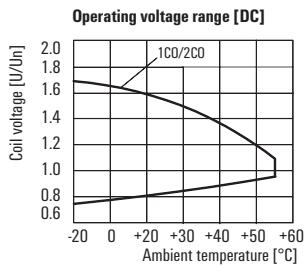

**DRL power relay**  
**1 CO AC/DC coil**

Type code	DRL			
Type	DRL			
Type of construction	170 1 change over contact			
	270 2 change over contacts			
Coil voltage	012 12 V DC / 024 24 V DC			
	048 48 V DC / 110 110 V DC			
	220 220 V DC / 524 24 V AC			
	615 115 V AC / 730 230 V AC			
LED indicator	L			

**Ordering data**

	12 V DC	24 V DC	48 V DC	110 V DC	220 V DC
<b>Input</b>					
Rated control voltage	12 V DC	24 V DC	48 V DC	110 V DC	220 V DC
Rated current AC / DC	/ 75 mA	/ 36.9 mA	/ 18.5 mA	/ 10 mA	/ 5.2 mA
Power rating	0.9 W	0.9 W	0.9 W	0.9 W	0.9 W
Pull-in/drop-out voltage, typ.	9 V / 1.2 V DC	18 V / 2.4 V DC	36 V / 4.8 V DC	82.5 V / 11 V DC	154 V / 22 V DC
Pull-in/drop-out current, typ.					
Status indicator	Green LED, Mechanical	Green LED, Mechanical	Green LED, Mechanical	Green LED, Mechanical	Green LED, Mechanical
<b>Output</b>					
Switch-on delay	< 20 ms	< 20 ms	< 20 ms	< 20 ms	< 20 ms
Switch-off delay	< 20 ms	< 20 ms	< 20 ms	< 20 ms	< 20 ms

Ordering data					
1 change over contact	Type	DRL170012L	DRL170024L	DRL170048L	DRL170110L
	Order No.	1133450000	1133460000	1133470000	1133480000
	Type				
	Order No.				
<b>Note</b>					

**Ordering data**

	24 V AC	115 V AC	230 V AC
<b>Input</b>			
Rated control voltage	24 V AC	115 V AC	230 V AC
Rated current AC / DC	54 mA /	12,9 mA /	6.8 mA /
Power rating	1.2 VA	1.2 VA	1.2 VA
Pull-in/drop-out voltage, typ.	19.2 V / 7.2 V AC	92 V / 34.5 V AC	184 V / 69 V AC
Pull-in/drop-out current, typ.			
Status indicator	red LED, Mechanical	red LED, Mechanical	red LED, Mechanical
<b>Output</b>			
Switch-on delay	< 20 ms	< 20 ms	< 20 ms
Switch-off delay	< 20 ms	< 20 ms	< 20 ms

Ordering data			
1 change over contact	Type	DRL170524L	DRL170615L
	Order No.	1133840000	1133850000
	Type		
	Order No.		
<b>Note</b>			



**D-SERIES – relay module**

**DRL power relay**

**2 CO AC/DC coil**

- High wear resistance in case of AC loads
- High dielectric strength: 2,000 V



**B**

**Circuit diagram**

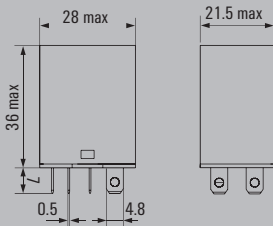
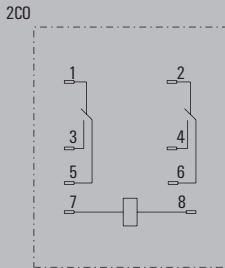

**Technical data**

Output	
Rated switching voltage / Continuous current	250 V AC / 10 A
Max. switching voltage, AC	250 V
Inrush current	
Min. switching power	12 V / 100 mA
DC / AC Switching capacity (resistive), max.	240 W @ 24 V / 2500 VA
Contact material	AgCdO
Mechanical service life	10 x 10 <sup>6</sup> switching cycles
Max. switching frequency at rated load	0.1 Hz
Rated data	
Ambient temperature (operational)	-25 °C...55 °C
Storage temperature	-25 °C...55 °C
Humidity	35 % to 85 % relative humidity level
Approvals	cURus; EAC
Insulation coordination (EN 50178)	
Rated voltage	250 V
Impulse withstand voltage	5 kV (1.2/50 µs)
Dielectric strength input - output	2 kV <sub>eff</sub> / 1 min
Dielectric strength, contact / contact	
Dielectric strength to mounting rail	
Creepage and clearance distance input - output	≥ 4 mm
Overvoltage category	III
Pollution degree	3
Dimensions	
Depth x width x height	mm 36 / 21.5 / 28
Plug-in connection	
Depth x width x height	mm 36 / 21.5 / 28
Note	

**Applications**

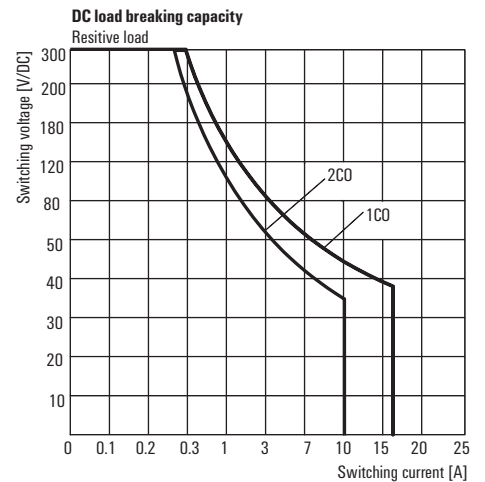
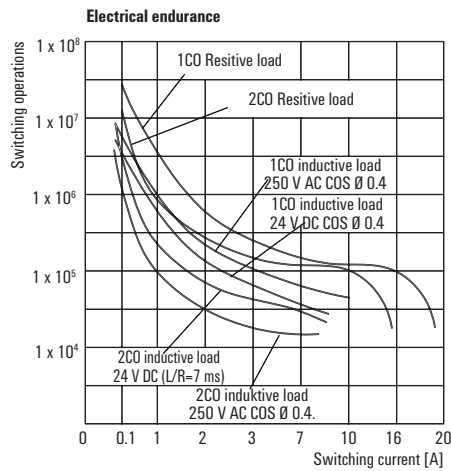
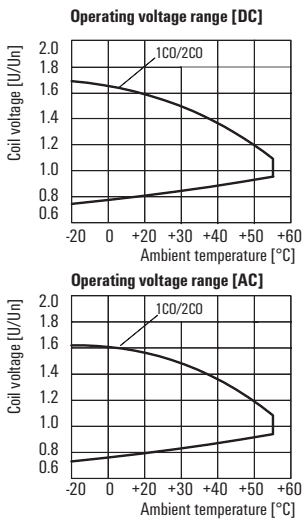

**DRL power relay  
2 CO AC/DC coil**

Type code	DRL			
Type	DRL			
Type of construction	170 1 change over contact 270 2 change over contacts			
Coil voltage	012 12 V DC / 024 24 V DC 048 48 V DC / 110 110 V DC 220 220 V DC / 524 24 V AC 615 115 V AC / 730 230 V AC			
LED indicator	L			

**Ordering data**

	12 V DC	24 V DC	48 V DC	110 V DC	220 V DC
<b>Input</b>					
Rated control voltage	12 V DC	24 V DC	48 V DC	110 V DC	220 V DC
Rated current AC / DC	/ 75 mA	/ 36.9 mA	/ 18.5 mA	/ 10 mA	/ 5.2 mA
Power rating	0.9 W	0.9 W	0.9 W	0.9 W	0.9 W
Pull-in/drop-out voltage, typ.	9 V / 1.2 V DC	18 V / 2.4 V DC	36 V / 4.8 V DC	82.5 V / 11 V DC	154 V / 22 V DC
Pull-in/drop-out current, typ.					
Status indicator	Green LED, Mechanical	Green LED, Mechanical	Green LED, Mechanical	Green LED, Mechanical	Green LED, Mechanical
<b>Output</b>					
Switch-on delay	< 20 ms	< 20 ms	< 20 ms	< 20 ms	< 20 ms
Switch-off delay	< 20 ms	< 20 ms	< 20 ms	< 20 ms	< 20 ms

Ordering data					
2 change over contacts Type	DRL270012L	DRL270024L	DRL270048L	DRL270110L	DRL270220L
Order No.	<b>1133510000</b>	<b>1133520000</b>	<b>1133530000</b>	<b>1133540000</b>	<b>1133550000</b>
Type					
Order No.					
<b>Note</b>					

**Ordering data**

	24 V AC	115 V AC	230 V AC
<b>Input</b>			
Rated control voltage	24 V AC	115 V AC	230 V AC
Rated current AC / DC	54 mA /	12,9 mA /	6.8 mA /
Power rating	1.2 VA	1.2 VA	1.2 VA
Pull-in/drop-out voltage, typ.	19.2 V / 7.2 V AC	92 V / 34.5 V AC	184 V / 69 V AC
Pull-in/drop-out current, typ.			
Status indicator	red LED, Mechanical	red LED, Mechanical	red LED, Mechanical
<b>Output</b>			
Switch-on delay	< 20 ms	< 20 ms	< 20 ms
Switch-off delay	< 20 ms	< 20 ms	< 20 ms

Ordering data			
2 change over contacts Type	DRL270524L	DRL270615L	DRL270730L
Order No.	<b>1133870000</b>	<b>1133880000</b>	<b>1133890000</b>
Type			
Order No.			
<b>Note</b>			

**D-SERIES – relay module**

**DRL power relay**

**3 CO AC/DC coil**

- High wear resistance in case of AC loads
- High dielectric strength: 2,000 V



**B**

**Circuit diagram**

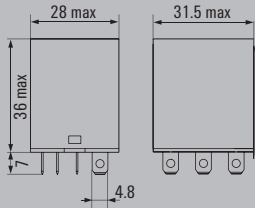
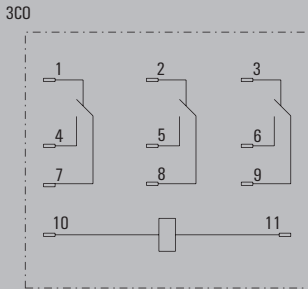

**Technical data**

Output	
Rated switching voltage / Continuous current	250 V AC / 10 A
Max. switching voltage, AC	250 V
Inrush current	
Min. switching power	12 V / 100 mA
DC / AC Switching capacity (resistive), max.	240 W @ 24 V / 2500 VA
Contact material	AgCdO
Mechanical service life	10 x 10 <sup>6</sup> switching cycles
Max. switching frequency at rated load	0.1 Hz
Rated data	
Ambient temperature (operational)	-25 °C...55 °C
Storage temperature	-25 °C...55 °C
Humidity	35 % to 85 % relative humidity level
Approvals	cURus; EAC
Insulation coordination (EN 50178)	
Rated voltage	250 V
Impulse withstand voltage	5 kV (1.2/50 µs)
Dielectric strength input - output	2 kV <sub>eff</sub> / 1 min
Dielectric strength, contact / contact	
Dielectric strength to mounting rail	
Creepage and clearance distance input - output	≥ 4 mm
Overtoltage category	III
Pollution degree	3
Dimensions	
Depth x width x height	mm 36 / 31.5 / 28
Plug-in connection	
Depth x width x height	mm 36 / 31.5 / 28
Note	

**Applications**

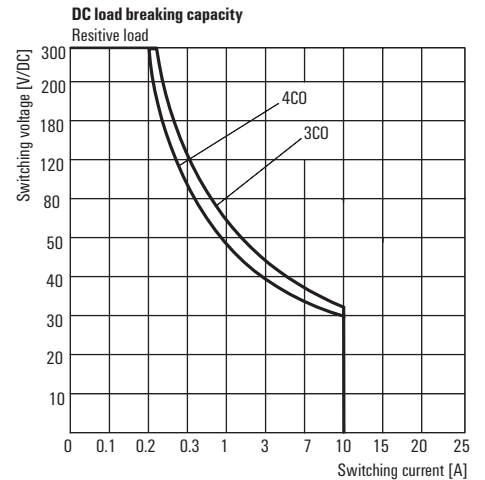
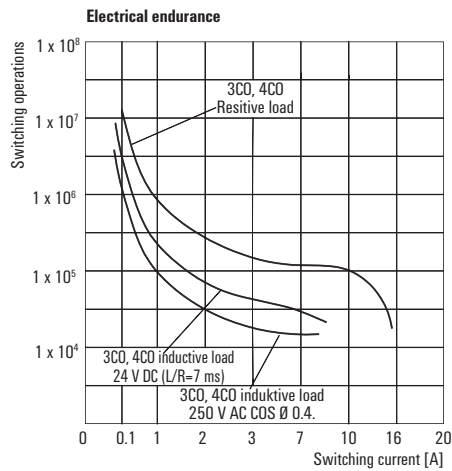
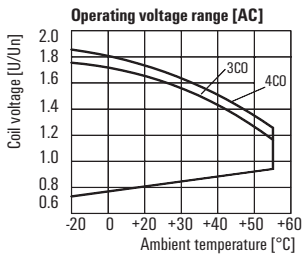
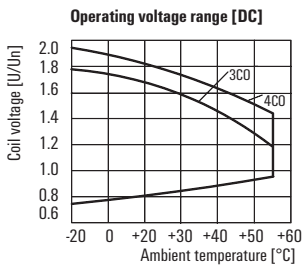

**DRL power relay  
3 CO AC/DC coil**

Type code	DRL			
Type	DRL			
Type of construction	370 3 change over contact 570 4 change over contacts			
Coil voltage	012 12 V DC / 024 24 V DC 048 48 V DC / 110 110 V DC 220 220 V DC / 524 24 V AC 615 115 V AC / 730 230 V AC			
LED indicator	L			

**Ordering data**

	12 V DC	24 V DC	48 V DC	110 V DC	220 V DC
<b>Input</b>					
Rated control voltage	12 V DC	24 V DC	48 V DC	110 V DC	220 V DC
Rated current AC / DC	/ 120 mA	/ 60 mA	/ 30 mA	/ 13.1 mA	/ 6.7 mA
Power rating	1.4 W	1.4 W	1.4 W	1.4 W	1.4 W
Pull-in/drop-out voltage, typ.	9 V / 1.2 V DC	18 V / 2.4 V DC	36 V / 4.8 V DC	82.5 V / 11 V DC	154 V / 22 V DC
Pull-in/drop-out current, typ.					
Status indicator	Green LED, Mechanical	Green LED, Mechanical	Green LED, Mechanical	Green LED, Mechanical	Green LED, Mechanical
<b>Output</b>					
Switch-on delay	< 20 ms	< 20 ms	< 20 ms	< 20 ms	< 20 ms
Switch-off delay	< 20 ms	< 20 ms	< 20 ms	< 20 ms	< 20 ms

Ordering data					
3 change over contacts Type	DRL370012L	DRL370024L	DRL370048L	DRL370110L	DRL370220L
Order No.	<b>1133570000</b>	<b>1133580000</b>	<b>1133590000</b>	<b>1133600000</b>	<b>1133610000</b>
Type					
Order No.					
<b>Note</b>					

**Ordering data**

	24 V AC	115 V AC	230 V AC
<b>Input</b>			
Rated control voltage	24 V AC	115 V AC	230 V AC
Rated current AC / DC	80 mA /	16 mA /	10 mA /
Power rating	2 VA	2 VA	2 VA
Pull-in/drop-out voltage, typ.	19.2 V / 7.2 V AC	92 V / 34.5 V AC	184 V / 69 V AC
Pull-in/drop-out current, typ.			
Status indicator	red LED, Mechanical	red LED, Mechanical	red LED, Mechanical
<b>Output</b>			
Switch-on delay	< 20 ms	< 20 ms	< 20 ms
Switch-off delay	< 20 ms	< 20 ms	< 20 ms

Ordering data			
3 change over contacts Type	DRL370524L	DRL370615L	DRL370730L
Order No.	<b>1133910000</b>	<b>1133920000</b>	<b>1133930000</b>
Type			
Order No.			
<b>Note</b>			

**D-SERIES – relay module**

**DRL power relay**

**4 CO AC/DC coil**

- High wear resistance in case of AC loads
- High dielectric strength: 2,000 V



**B**

**Circuit diagram**

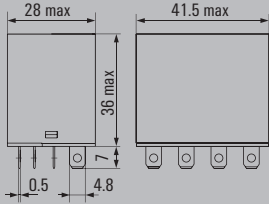
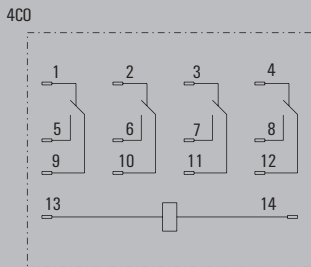

**Technical data**

Output	
Rated switching voltage / Continuous current	250 V AC / 10 A
Max. switching voltage, AC	250 V
Inrush current	
Min. switching power	12 V / 100 mA
DC / AC Switching capacity (resistive), max.	240 W @ 24 V / 2500 VA
Contact material	AgCdO
Mechanical service life	10 x 10 <sup>6</sup> switching cycles
Max. switching frequency at rated load	0.1 Hz
Rated data	
Ambient temperature (operational)	-25 °C...55 °C
Storage temperature	-25 °C...55 °C
Humidity	35 % to 85 % relative humidity level
Approvals	cURus; EAC
Insulation coordination (EN 50178)	
Rated voltage	250 V
Impulse withstand voltage	5 kV (1.2/50 µs)
Dielectric strength input - output	2 kV <sub>eff</sub> / 1 min
Dielectric strength, contact / contact	
Dielectric strength to mounting rail	
Creepage and clearance distance input - output	≥ 4 mm
Overvoltage category	III
Pollution degree	3
Dimensions	
Depth x width x height	mm 36 / 41.5 / 28
Plug-in connection	
Depth x width x height	mm 36 / 41.5 / 28
Note	

**Applications**

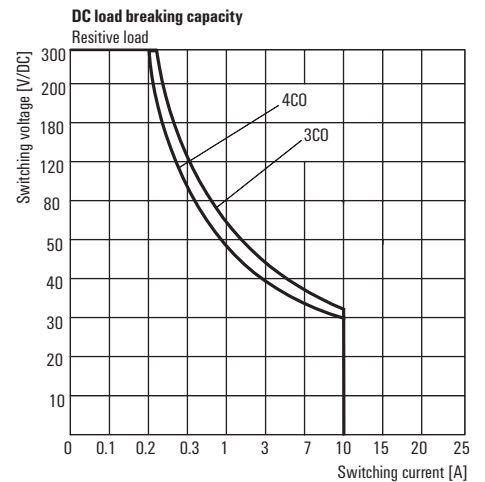
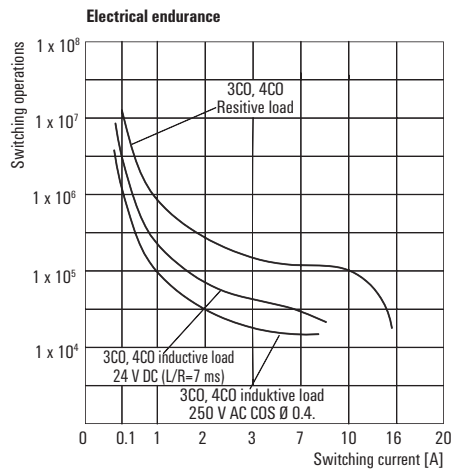
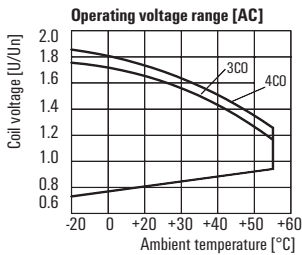
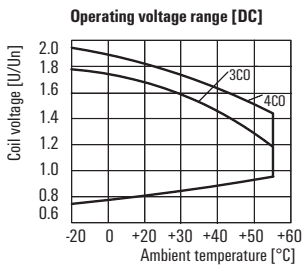

**DRL power relay  
4 CO AC/DC coil**

Type code	DRL			
Type	DRL			
Type of construction	370 3 change over contact 570 4 change over contacts			
Coil voltage	012 12 V DC / 024 24 V DC 048 48 V DC / 110 110 V DC 220 220 V DC / 524 24 V AC 615 115 V AC / 730 230 V AC			
LED indicator	L			

**Ordering data**

	12 V DC	24 V DC	48 V DC	110 V DC	220 V DC
<b>Input</b>					
Rated control voltage	12 V DC	24 V DC	48 V DC	110 V DC	220 V DC
Rated current AC / DC	/ 125 mA	/ 66.7 mA	/ 31.2 mA	/ 16.2 mA	/ 7.6 mA
Power rating	1.5 W	1.5 W	1.5 W	1.5 W	1.5 W
Pull-in/drop-out voltage, typ.	9 V / 1.2 V DC	18 V / 2.4 V DC	36 V / 4.8 V DC	82.5 V / 11 V DC	154 V / 22 V DC
Pull-in/drop-out current, typ.					
Status indicator	Green LED, Mechanical	Green LED, Mechanical	Green LED, Mechanical	Green LED, Mechanical	Green LED, Mechanical
<b>Output</b>					
Switch-on delay	< 20 ms	< 20 ms	< 20 ms	< 20 ms	< 20 ms
Switch-off delay	< 20 ms	< 20 ms	< 20 ms	< 20 ms	< 20 ms

Ordering data					
4 change over contacts					
Type	DRL570012L	DRL570024L	DRL570048L	DRL570110L	DRL570220L
Order No.	<b>1133620000</b>	<b>1133630000</b>	<b>1133640000</b>	<b>1133650000</b>	<b>1133660000</b>
Type					
Order No.					
<b>Note</b>					

**Ordering data**

	24 V AC	115 V AC	230 V AC
<b>Input</b>			
Rated control voltage	24 V AC	115 V AC	230 V AC
Rated current AC / DC	/ 93.5 mA	/ 25.5 mA	/ 13.1 mA
Power rating	2.5 VA	2.5 VA	2.5 VA
Pull-in/drop-out voltage, typ.	19.2 V / 7.2 V AC	92 V / 34.5 V AC	184 V / 69 V AC
Pull-in/drop-out current, typ.			
Status indicator	red LED, Mechanical	red LED, Mechanical	red LED, Mechanical
<b>Output</b>			
Switch-on delay	< 20 ms	< 20 ms	< 20 ms
Switch-off delay	< 20 ms	< 20 ms	< 20 ms

Ordering data			
4 change over contacts			
Type	DRL570524L	DRL570615L	DRL570730L
Order No.	<b>1133940000</b>	<b>1133950000</b>	<b>1133960000</b>
Type			
Order No.			
<b>Note</b>			

**D-SERIES – DRL relays accessories**

**Accessories for DRL relay**



**Ordering data**

Technical data	
Rated voltage	300 V
Rated current	10 A
Dielectric strength for input - output	2,000 V
Dielectric strength between the contacts	2,500 V
Ambient temperature (operational)	-40 ... 85 °C
Pollution severity	2
Over voltage class	III
Max. torque	1.0 Nm
Wire cross section	0.5 ... 2.5 mm <sup>2</sup>
Protection class (IEC 61810)	IP10
Approvals	CE, cURus
Description	
Socket, snaps onto DIN-rail, 2CO	
Socket, snaps onto DIN-rail, 3CO	
Socket, snaps onto DIN-rail, 4CO	

Type	Qty.	Order No.
SLD F 2CO	10	7760056225
SLD F 3CO	10	7760056226
SLD F 4CO	10	7760056227

**Ordering data**

Technical data		Order No.
Metal clips SLD F 2CO	SLD clip 2CO	7760056108
Metal clips SLD F 3CO	SLD clip 3CO	7760056234
Metal clips SLD F 4CO	SLD clip 4CO	7760056235

**Ordering data**

Technical data		Order No.
Free-wheel diode 6...230 V DC, for SLD F 2CO/3CO	RIM 1 6/230 V DC	7760056169
RC element 110...230 V AC, for SLD F 2CO/3CO	RIM 3 110/230 V AC	7760056014
RC element 6 ... 230 V AC, for SLD F 4CO	RIM 5 6/230 V AC	1174670000
Free-wheel diode 6...230 V DC, for SLD F 4CO	RIM 5 6/230 V DC	1174650000

**Dimensions in mm**

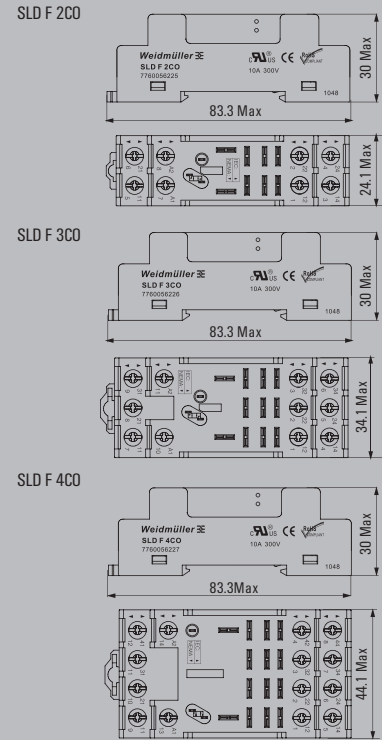





**D-SERIES – relay module**

**DRW power relay**

**2 CO AC/DC coil**

**3 CO AC/DC coil**

- Suitable for switching high load voltages
- With LED and test lever



**B**

**Circuit diagram**

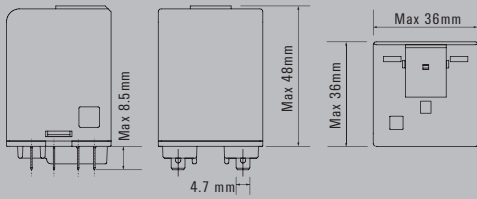
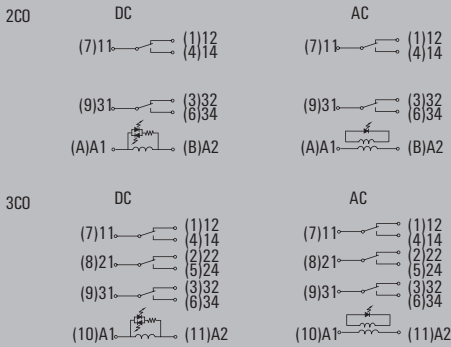

**Technical data**

Output	
Rated switching voltage / Continuous current	400 VAC / 16 A
Max. switching voltage, AC	400 V
Inrush current	
Min. switching power	12 V / 100 mA
DC / AC Switching capacity (resistive), max.	384 W @ 24 V / 6400 VA
Contact material	AgCdO
Mechanical service life	10 x 10 <sup>6</sup> switching cycles
Max. switching frequency at rated load	1 Hz
Rated data	
Ambient temperature (operational)	-40 °C...60 °C
Storage temperature	-40 °C...60 °C
Humidity	35 % to 85 % relative humidity level
Approvals	cURus
Insulation coordination (EN 50178)	
Rated voltage	400 V
Impulse withstand voltage	6 kV (1.2/50 μs)
Dielectric strength input - output	2.5 KV <sub>eff</sub> / 1 min.
Dielectric strength, contact / contact	
Dielectric strength to mounting rail	
Creepage and clearance distance input - output	≥ 5.5 mm
Overvoltage category	III
Pollution degree	3
Dimensions	
Depth x width x height	mm 48 / 36 / 36
Plug-in connection	
Depth x width x height	mm 48 / 36 / 36
Note	

**Applications**

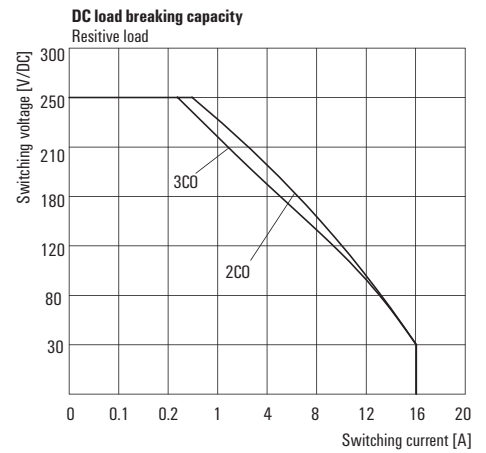
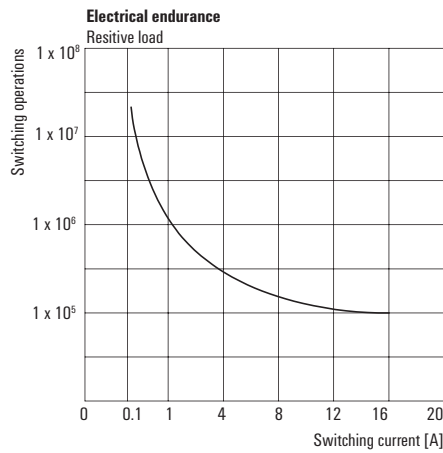
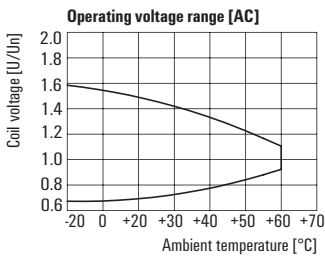
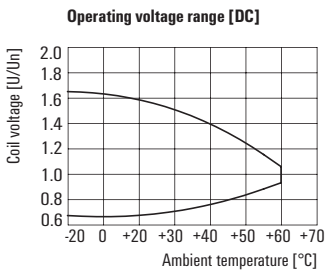

**DRW power relay**  
**2 CO AC/DC coil**  
**3 CO AC/DC coil**

Type code	DRW			
Type	DRW			
Type of construction	270 2CO 174 1NC			
Coil voltage	012 12 V DC / 024 24 V DC 048 48 V DC / 110 110 V DC 220 220 V DC / 524 24 V AC 548 48 V AC / 615 115 V AC 730 230 V AC / 900 400 V AC			
With LED and test lever	LT			

**Ordering data**

	12 V DC	24 V DC	48 V DC	110 V DC	220 V DC
<b>Input</b>					
Rated control voltage	12 V DC	24 V DC	48 V DC	110 V DC	220 V DC
Rated current AC / DC	/ 120 mA	/ 60 mA	/ 30 mA	/ 13 mA	/ 6.7 mA
Power rating	1.5 W	1.5 W	1.5 W	1.5 W	1.5 W
Pull-in/drop-out voltage, typ.	9 V / 1.2 V DC	18 V / 2.4 V DC	36 V / 4.8 V DC	82.5 V / 11 V DC	165 V / 22 V DC
Pull-in/drop-out current, typ.					
Status indicator	Green LED, Mechanical	Green LED, Mechanical	Green LED, Mechanical	Green LED, Mechanical	Green LED, Mechanical
<b>Output</b>					
Switch-on delay	< 20 ms	< 20 ms	< 20 ms	< 20 ms	< 20 ms
Switch-off delay	< 10 ms	< 10 ms	< 10 ms	< 10 ms	< 10 ms
<b>Ordering data</b>					
2 CO contact Type	DRW270012LT	DRW270024LT	DRW270048LT	DRW270110LT	DRW270220LT
Order No.	<b>1219730000</b>	<b>1219740000</b>	<b>1219750000</b>	<b>1219760000</b>	<b>1219770000</b>
3 CO contact Type	DRW370012LT	DRW370024LT	DRW370048LT	DRW370110LT	DRW370220LT
Order No.	<b>1219780000</b>	<b>1219790000</b>	<b>1219810000</b>	<b>1219820000</b>	<b>1219830000</b>
<b>Ordering data</b>					
<b>Test-button lock</b>					
Type	Test Lever Block DRH/DRW	Test Lever Block DRH/DRW	Test Lever Block DRH/DRW	Test Lever Block DRH/DRW	Test Lever Block DRH/DRW
Order No.	<b>7760056249</b>	<b>7760056249</b>	<b>7760056249</b>	<b>7760056249</b>	<b>7760056249</b>
<b>Note</b>					

**Ordering data**

	24 V AC	48 V AC	115 V AC	230 V AC	400 V AC
<b>Input</b>					
Rated control voltage	24 V AC	48 V AC	115 V AC	230 V AC	400 V AC
Rated current AC / DC	101.7 mA /	50.5 mA /	21 mA /	10,6 mA /	6.1 mA /
Power rating	2.5 VA	2.5 VA	2.5 VA	2.5 VA	2.5 VA
Pull-in/drop-out voltage, typ.	19.2 V / 7.2 V AC	38.4 V / 14.4 V AC	92 V / 34.5 V AC	184 V / 69 V AC	320 V / 120 V AC
Pull-in/drop-out current, typ.					
Status indicator	red LED, Mechanical	red LED, Mechanical	red LED, Mechanical	red LED, Mechanical	red LED, Mechanical
<b>Output</b>					
Switch-on delay	< 20 ms	< 20 ms	< 20 ms	< 20 ms	< 20 ms
Switch-off delay	< 10 ms	< 10 ms	< 10 ms	< 10 ms	< 10 ms
<b>Ordering data</b>					
2 CO contact Type	DRW270524LT	DRW270548LT	DRW270615LT	DRW270730LT	DRW270900LT
Order No.	<b>1219350000</b>	<b>1219360000</b>	<b>1219370000</b>	<b>1219380000</b>	<b>1219390000</b>
3 CO contact Type	DRW370524LT	DRW370548LT	DRW370615LT	DRW370730LT	DRW370900LT
Order No.	<b>1219410000</b>	<b>1219420000</b>	<b>1219430000</b>	<b>1219440000</b>	<b>1219450000</b>
<b>Ordering data</b>					
<b>Test-button lock</b>					
Type	Test Lever Block DRH/DRW	Test Lever Block DRH/DRW	Test Lever Block DRH/DRW	Test Lever Block DRH/DRW	Test Lever Block DRH/DRW
Order No.	<b>7760056249</b>	<b>7760056249</b>	<b>7760056249</b>	<b>7760056249</b>	<b>7760056249</b>
<b>Note</b>					

**D-SERIES – relay module**

**DRH DC relay**

- 1 NO AC/DC coil**
- 1 NC AC/DC coil**

- Suitable for switching high DC loads
- With blowout magnet
- With LED and test button
- For switching high DC loads up to 10 A at 220 V DC



**B**

**Circuit diagram**

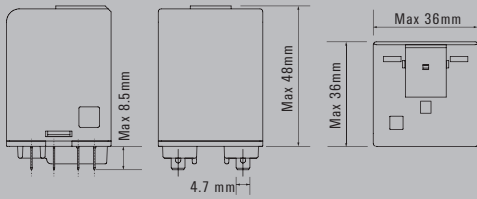
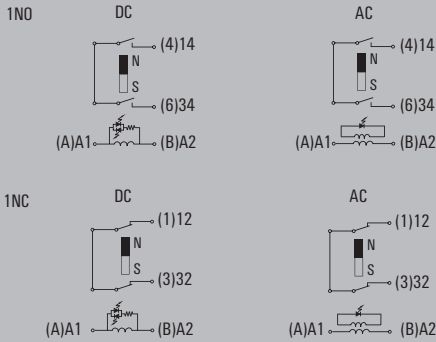

**Technical data**

Output	
Rated switching voltage / Continuous current	500 V AC / 16 A
Max. switching voltage, AC	500 V
Inrush current	
Min. switching power	12 V / 100 mA
DC / AC Switching capacity (resistive), max.	2200 W @ 220 V / 8000 VA
Contact material	AgSnO2
Mechanical service life	10 x 10 <sup>6</sup> switching cycles
Max. switching frequency at rated load	1 Hz
Rated data	
Ambient temperature (operational)	-40 °C...60 °C
Storage temperature	-40 °C...60 °C
Humidity	35 % to 85 % relative humidity level
Approvals	cURus; EAC
Insulation coordination (EN 50178)	
Rated voltage	400 V
Impulse withstand voltage	6 kV (1.2/50 µs)
Dielectric strength input - output	4 kV <sub>eff</sub> / 1 min
Dielectric strength, contact / contact	
Dielectric strength to mounting rail	
Creepage and clearance distance input - output	≥ 5.5 mm
Overvoltage category	III
Pollution degree	3
Dimensions	
Depth x width x height	mm 48 / 36 / 36
Plug-in connection	
Depth x width x height	mm 48 / 36 / 36

**Note**

**Applications**

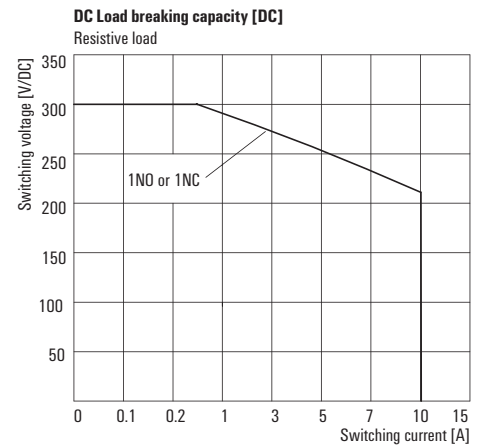
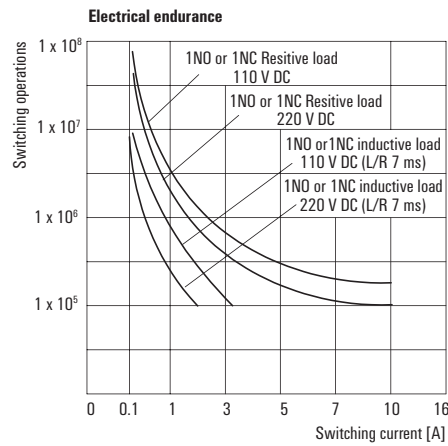
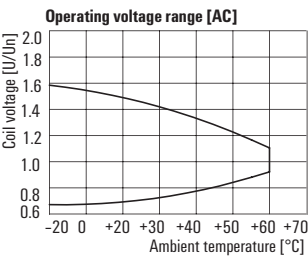
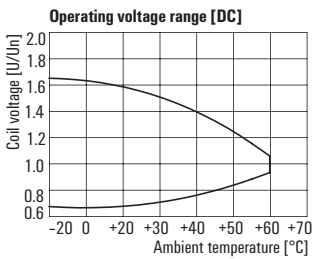

**DRH DC relay**  
**1 NO AC/DC coil**  
**1 NC AC/DC coil**

<b>Type code</b>	DRH				
Type	DRH				
Type of construction	173 1NO		174 1NC		
Coil voltage	012	12 V DC / 024	24 V DC		
	048	48 V DC / 110	110 V DC		
	220	220 V DC / 524	24 V AC		
	548	48 V AC / 615	115 V AC		
	730	230 V AC			
With LED and test lever	LT				

**Ordering data**

	12 V DC	24 V DC	48 V DC	110 V DC	220 V DC
<b>Input</b>					
Rated control voltage	12 V DC	24 V DC	48 V DC	110 V DC	220 V DC
Rated current AC / DC	/ 120 mA	/ 60 mA	/ 30 mA	/ 13 mA	/ 6.7 mA
Power rating	1.5 W	1.5 W	1.5 W	1.5 W	1.5 W
Pull-in/drop-out voltage, typ.	9 V / 1.2 V DC	18 V / 2.4 V DC	36 V / 4.8 V DC	82.5 V / 11 V DC	154 V / 22 V DC
Pull-in/drop-out current, typ.					
Status indicator	Green LED, Mechanical	Green LED, Mechanical	Green LED, Mechanical	Green LED, Mechanical	red LED, Mechanical
<b>Output</b>					
Switch-on delay	< 20 ms	< 20 ms	< 20 ms	< 20 ms	< 20 ms
Switch-off delay	< 20 ms	< 20 ms	< 20 ms	< 20 ms	< 20 ms
<b>Ordering data</b>					
1 NO contact Type	DRH173012LT	DRH173024LT	DRH173048LT	DRH173110LT	DRH173220LT
Order No.	<b>1219840000</b>	<b>1219850000</b>	<b>1219860000</b>	<b>1219870000</b>	<b>1219880000</b>
1 NC contact Type	DRH174012LT	DRH174024LT	DRH174048LT	DRH174110LT	DRH174220LT
Order No.	<b>1219940000</b>	<b>1219950000</b>	<b>1219960000</b>	<b>1219970000</b>	<b>1219980000</b>
<b>Ordering data</b>					
<b>Test-button lock</b>					
Type	Test Lever Block DRH/DRW	Test Lever Block DRH/DRW	Test Lever Block DRH/DRW	Test Lever Block DRH/DRW	Test Lever Block DRH/DRW
Order No.	<b>7760056249</b>	<b>7760056249</b>	<b>7760056249</b>	<b>7760056249</b>	<b>7760056249</b>
<b>Note</b>					

**Ordering data**

	24 V AC	48 V AC	115 V AC	230 V AC
<b>Input</b>				
Rated control voltage	24 V AC	48 V AC	115 V AC	230 V AC
Rated current AC / DC	101.7 mA /	50.5 mA /	21 mA /	10,6 mA /
Power rating	2.5 VA	2.5 VA	2.5 VA	2.5 VA
Pull-in/drop-out voltage, typ.	19.2 V / 7.2 V AC	38.4 V / 14.4 V AC	92 V / 34.5 V AC	184 V / 69 V AC
Pull-in/drop-out current, typ.				
Status indicator	red LED, Mechanical	red LED, Mechanical	red LED, Mechanical	red LED, Mechanical
<b>Output</b>				
Switch-on delay	< 20 ms	< 20 ms	< 20 ms	< 20 ms
Switch-off delay	< 20 ms	< 20 ms	< 20 ms	< 20 ms
<b>Ordering data</b>				
1 NO contact Type	DRH173524LT	DRH173548LT	DRH173615LT	DRH173730LT
Order No.	<b>1219890000</b>	<b>1219910000</b>	<b>1219920000</b>	<b>1219930000</b>
1 NC contact Type	DRH174524LT	DRH174548LT	DRH174615LT	DRH174730LT
Order No.	<b>1219990000</b>	<b>1220010000</b>	<b>1220020000</b>	<b>1220030000</b>
<b>Ordering data</b>				
<b>Test-button lock</b>				
Type	Test Lever Block DRH/DRW	Test Lever Block DRH/DRW	Test Lever Block DRH/DRW	Test Lever Block DRH/DRW
Order No.	<b>7760056249</b>	<b>7760056249</b>	<b>7760056249</b>	<b>7760056249</b>
<b>Note</b>				

**D-SERIES – relay module**

**DRH DC relay**

**1 NO / 1 NC AC/DC coil**

- Suitable for switching high DC loads
- With blowout magnet
- With LED and test button
- For switching high DC loads up to 3 A at 220 V DC



**B**

**Circuit diagram**

**1NO/1NC**

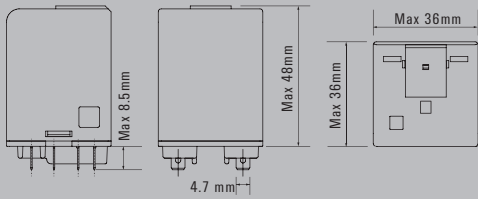
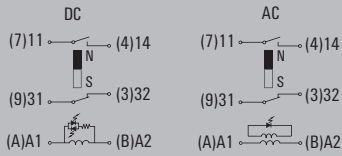

**Technical data**

Output	
Rated switching voltage / Continuous current	250 V AC / 16 A
Max. switching voltage, AC	250 V
Inrush current	
Min. switching power	12 V / 100 mA
DC / AC Switching capacity (resistive), max.	660 W @ 220 V / 4000 VA
Contact material	AgSnO2
Mechanical service life	10 x 10 <sup>6</sup> switching cycles
Max. switching frequency at rated load	1 Hz
Rated data	
Ambient temperature (operational)	-40 °C...60 °C
Storage temperature	-40 °C...60 °C
Humidity	35 % to 85 % relative humidity level
Approvals	cURus; EAC
Insulation coordination (EN 50178)	
Rated voltage	400 V
Impulse withstand voltage	6 kV (1.2/50 µs)
Dielectric strength input - output	4 kV <sub>eff</sub> / 1 min
Dielectric strength, contact / contact	
Dielectric strength to mounting rail	
Creepage and clearance distance input - output	≥ 5.5 mm
Overvoltage category	III
Pollution degree	3
Dimensions	
Depth x width x height	mm 48 / 36 / 36
Plug-in connection	
Depth x width x height	mm 48 / 36 / 36

**Note**

**Applications**

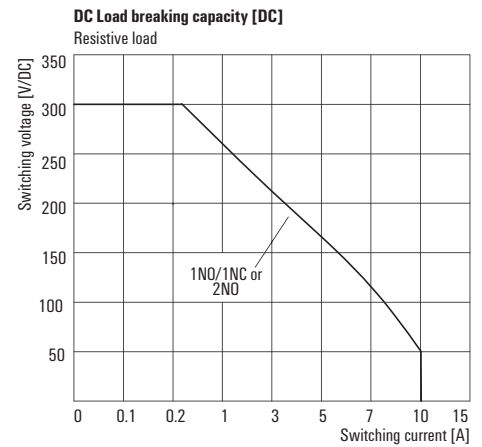
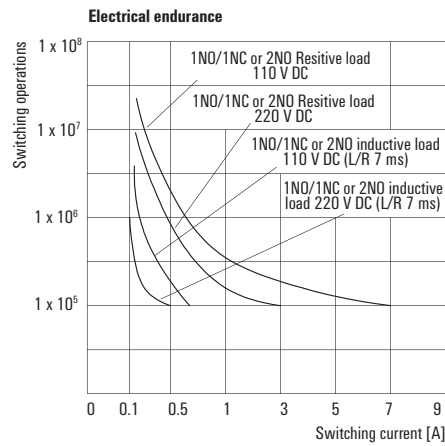
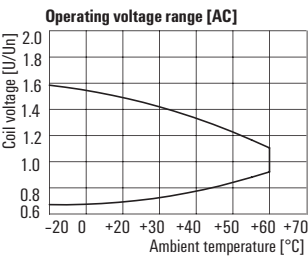
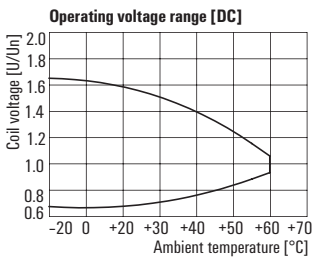

**DRH DC relay**  
1 NO / 1 NC AC/DC coil

<b>Type code</b>	DRH			
Type	DRH			
Type of construction	275 1NO/1NC			
	276 2NO			
<b>Coil voltage</b>	012 12 V DC / 024 24 V DC			
	048 48 V DC / 110 110 V DC			
	220 220 V DC / 524 24 V AC			
	548 48 V AC / 615 115 V AC			
	730 230 V AC			
<b>With LED and test lever</b>	LT			

**Ordering data**

	12 V DC	24 V DC	48 V DC	110 V DC	220 V DC
<b>Input</b>					
Rated control voltage	12 V DC	24 V DC	48 V DC	110 V DC	220 V DC
Rated current AC / DC	/ 120 mA	/ 60 mA	/ 30 mA	/ 13 mA	/ 6.7 mA
Power rating	1.5 W	1.5 W	1.5 W	1.5 W	1.5 W
Pull-in/drop-out voltage, typ.	9 V / 1.2 V DC	18 V / 2.4 V DC	36 V / 4.8 V DC	82.5 V / 11 V DC	154 V / 22 V DC
Pull-in/drop-out current, typ.					
Status indicator	Green LED, Mechanical	Green LED, Mechanical	Green LED, Mechanical	Green LED, Mechanical	Green LED, Mechanical
<b>Output</b>					
Switch-on delay	< 20 ms	< 20 ms	< 20 ms	< 20 ms	< 20 ms
Switch-off delay	< 20 ms	< 20 ms	< 20 ms	< 20 ms	< 20 ms
<b>Ordering data</b>					
1 NO / 1 NC contact	DRH275012LT	DRH275024LT	DRH275048LT	DRH275110LT	DRH275220LT
Type					
Order No.	1220040000	1220050000	1220060000	1220070000	1220080000
Type					
Order No.					
<b>Ordering data</b>					
<b>Test-button lock</b>					
Type	Test Lever Block DRH/DRW	Test Lever Block DRH/DRW	Test Lever Block DRH/DRW	Test Lever Block DRH/DRW	Test Lever Block DRH/DRW
Order No.	7760056249	7760056249	7760056249	7760056249	7760056249
<b>Note</b>					

**Ordering data**

	24 V AC	48 V AC	115 V AC	230 V AC
<b>Input</b>				
Rated control voltage	24 V AC	48 V AC	115 V AC	230 V AC
Rated current AC / DC	101.7 mA /	50.5 mA /	21 mA /	10,6 mA /
Power rating	2.5 VA	2.5 VA	2.5 VA	2.5 VA
Pull-in/drop-out voltage, typ.	19.2 V / 7.2 V AC	38.4 V / 14.4 V AC	92 V / 34.5 V AC	184 V / 69 V AC
Pull-in/drop-out current, typ.				
Status indicator	red LED, Mechanical	red LED, Mechanical	red LED, Mechanical	red LED, Mechanical
<b>Output</b>				
Switch-on delay	< 20 ms	< 20 ms	< 20 ms	< 20 ms
Switch-off delay	< 20 ms	< 20 ms	< 20 ms	< 20 ms
<b>Ordering data</b>				
1 NO / 1 NC contact	DRH275524LT	DRH275548LT	DRH275615LT	DRH275730LT
Type				
Order No.	1220090000	1220110000	1220120000	1220130000
Type				
Order No.				
<b>Ordering data</b>				
<b>Test-button lock</b>				
Type	Test Lever Block DRH/DRW	Test Lever Block DRH/DRW	Test Lever Block DRH/DRW	Test Lever Block DRH/DRW
Order No.	7760056249	7760056249	7760056249	7760056249
<b>Note</b>				

**D-SERIES – relay module**

**DRH DC relay**  
**2 NO AC/DC coil**

- Suitable for switching high DC loads
- With blowout magnet
- With LED and test button
- For switching high DC loads up to 3 A at 220 V DC



**B**

**Circuit diagram**

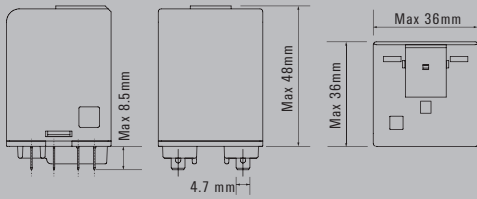
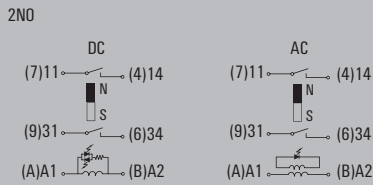

**Technical data**

Output	
Rated switching voltage / Continuous current	250 V AC / 16 A
Max. switching voltage, AC	250 V
Inrush current	
Min. switching power	12 V / 100 mA
DC / AC Switching capacity (resistive), max.	660 W @ 220 V / 4000 VA
Contact material	AgSnO2
Mechanical service life	10 x 10 <sup>6</sup> switching cycles
Max. switching frequency at rated load	1 Hz
Rated data	
Ambient temperature (operational)	-40 °C...60 °C
Storage temperature	-40 °C...60 °C
Humidity	35 % to 85 % relative humidity level
Approvals	cURus; EAC
Insulation coordination (EN 50178)	
Rated voltage	400 V
Impulse withstand voltage	6 kV (1.2/50 µs)
Dielectric strength input - output	4 kV <sub>eff</sub> / 1 min
Dielectric strength, contact / contact	
Dielectric strength to mounting rail	
Creepage and clearance distance input - output	≥ 5.5 mm
Overvoltage category	III
Pollution degree	3
Dimensions	
Depth x width x height	mm 48 / 36 / 36
Plug-in connection	
Depth x width x height	mm 48 / 36 / 36

**Note**

**Applications**

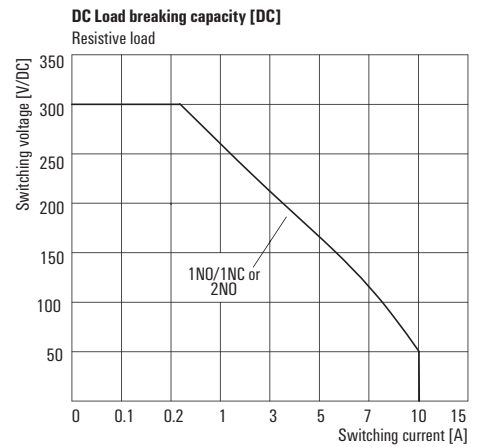
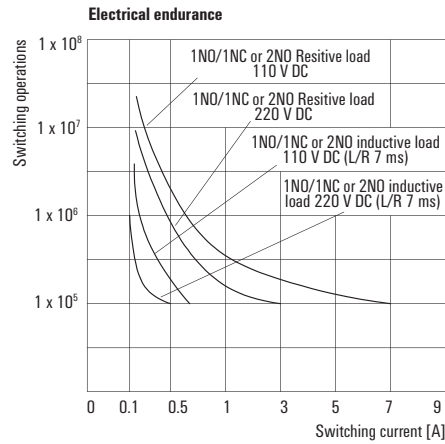
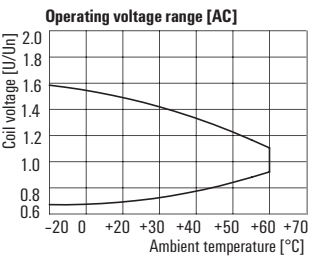
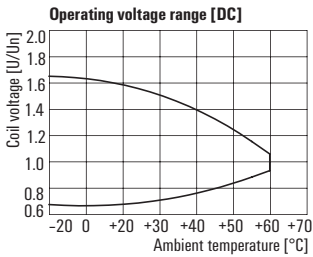

**DRH DC relay**  
**2 NO AC/DC coil**

<b>Type code</b>	DRH			
Type	DRH			
Type of construction	275 1NO/1NC			
	276 2NO			
<b>Coil voltage</b>	012 12 V DC / 024 24 V DC			
	048 48 V DC / 110 110 V DC			
	220 220 V DC / 524 24 V AC			
	548 48 V AC / 615 115 V AC			
	730 230 V AC			
<b>With LED and test lever</b>	LT			

**Ordering data**

	12 V DC	24 V DC	48 V DC	110 V DC	220 V DC
<b>Input</b>					
Rated control voltage	12 V DC	24 V DC	48 V DC	110 V DC	220 V DC
Rated current AC / DC	/ 120 mA	/ 60 mA	/ 30 mA	/ 13 mA	/ 6.7 mA
Power rating	1.5 W	1.5 W	1.5 W	1.5 W	1.5 W
Pull-in/drop-out voltage, typ.	9 V / 1.2 V DC	18 V / 2.4 V DC	36 V / 4.8 V DC	82.5 V / 11 V DC	154 V / 22 V DC
Pull-in/drop-out current, typ.					
Status indicator	Green LED, Mechanical	Green LED, Mechanical	Green LED, Mechanical	Green LED, Mechanical	Green LED, Mechanical
<b>Output</b>					
Switch-on delay	< 20 ms	< 20 ms	< 20 ms	< 20 ms	< 20 ms
Switch-off delay	< 20 ms	< 20 ms	< 20 ms	< 20 ms	< 20 ms
<b>Ordering data</b>					
2 NO contact	Type DRH276012LT	Type DRH276024LT	Type DRH276048LT	Type DRH276110LT	Type DRH276220LT
Order No.	1220140000	1220150000	1220170000	1220180000	1220190000
Type					
Order No.					
<b>Ordering data</b>					
<b>Test-button lock</b>					
Type	Test Lever Block DRH/DRW	Test Lever Block DRH/DRW	Test Lever Block DRH/DRW	Test Lever Block DRH/DRW	Test Lever Block DRH/DRW
Order No.	7760056249	7760056249	7760056249	7760056249	7760056249
<b>Note</b>					

**Ordering data**

	24 V AC	48 V AC	115 V AC	230 V AC
<b>Input</b>				
Rated control voltage	24 V AC	48 V AC	115 V AC	230 V AC
Rated current AC / DC	101.7 mA /	50.5 mA /	21 mA /	10,6 mA /
Power rating	2.5 VA	2.5 VA	2.5 VA	2.5 VA
Pull-in/drop-out voltage, typ.	19.2 V / 7.2 V AC	38.4 V / 14.4 V AC	92 V / 34.5 V AC	184 V / 69 V AC
Pull-in/drop-out current, typ.				
Status indicator	red LED, Mechanical	red LED, Mechanical	red LED, Mechanical	red LED, Mechanical
<b>Output</b>				
Switch-on delay	< 20 ms	< 20 ms	< 20 ms	< 20 ms
Switch-off delay	< 20 ms	< 20 ms	< 20 ms	< 20 ms
<b>Ordering data</b>				
2 NO contact	Type DRH276524LT	Type DRH276548LT	Type DRH276615LT	Type DRH276730LT
Order No.	1220200000	1220210000	1220220000	1220230000
Type				
Order No.				
<b>Ordering data</b>				
<b>Test-button lock</b>				
Type	Test Lever Block DRH/DRW	Test Lever Block DRH/DRW	Test Lever Block DRH/DRW	Test Lever Block DRH/DRW
Order No.	7760056249	7760056249	7760056249	7760056249
<b>Note</b>				



**D-SERIES – DRH and DRW relays accessories**

**Accessories for DRH and DRW relay**



**Dimensions in mm**

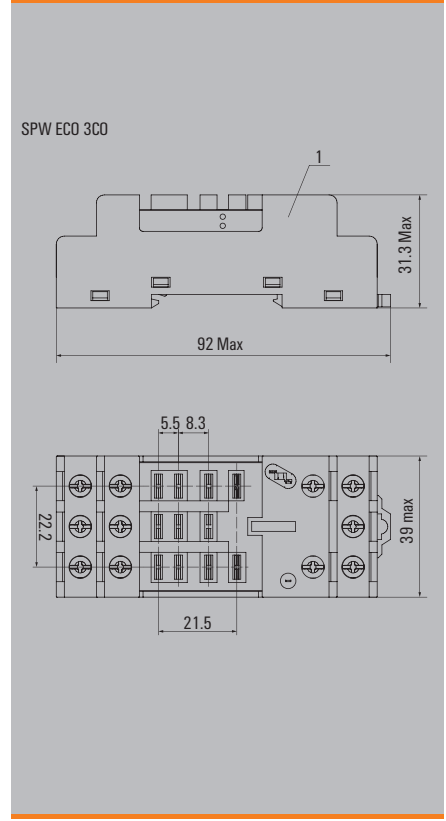

**Ordering data**

Technical data	
Rated voltage	400 V AC
Rated current	16 A
Dielectric strength for input - output	4,000 V
Dielectric strength between the contacts	4,000 V
Ambient temperature (operational)	-40 ... 60 °C
Pollution severity	2
Over voltage class	II
Max. torque/max.	1.2 Nm
Wire cross section	0.5 ... 4 mm <sup>2</sup>
Protection class (IEC 61810)	IP10
Weight	64 g
Approvals	CE, cURus
Description	
Socket, snaps onto DIN-rail, 3C0	
Metal clip	

Type	Qty.	Order No.
SPW ECO 3C0	10	1220250000
Metal clip DRH/DRW	10	1220260000



**Functional modules**

Technical data	
RC element 6 ... 230 V AC	
Free-wheel diode 6 ... 230 V DC	

	Order No.
RIM 5 6/230 V AC	1174670000
RIM 5 6/230 V DC	1174650000



**D-SERIES – relay module**

**DRR power relay**

**2 CO AC/DC coil**

- 2,500 VA switching capacity
- 8-pole relay



**B**

**Circuit diagram**

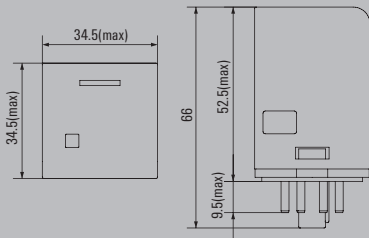
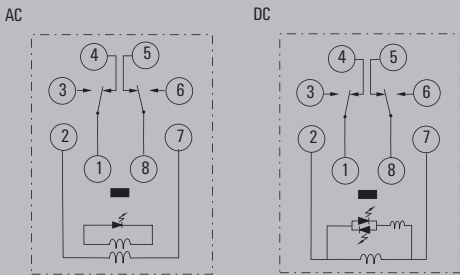

**Technical data**

Output	
Rated switching voltage / Continuous current	250 V AC / 10 A
Max. switching voltage, AC	250 V
Inrush current	
Min. switching power	12 V / 100 mA
DC / AC Switching capacity (resistive), max.	240 W @ 24 V / 2500 VA
Contact material	AgNi
Mechanical service life	10 x 10 <sup>6</sup> switching cycles
Max. switching frequency at rated load	0.1 Hz
Rated data	
Ambient temperature (operational)	-25 °C...55 °C
Storage temperature	-25 °C...55 °C
Humidity	5...85 % rel. humidity, no condensation
Approvals	EAC
Insulation coordination (EN 50178)	
Rated voltage	250 V
Impulse withstand voltage	4 kV (1.2/50 µs)
Dielectric strength input - output	2.5 KV <sub>eff</sub> / 1 min.
Dielectric strength, contact / contact	
Dielectric strength to mounting rail	
Creepage and clearance distance input - output	≥ 3 mm
Overvoltage category	III
Pollution degree	3
Dimensions	
Depth x width x height	mm 66 / 34.5 / 34.5
Plug-in connection	
Depth x width x height	mm 66 / 34.5 / 34.5
Note	

**Applications**

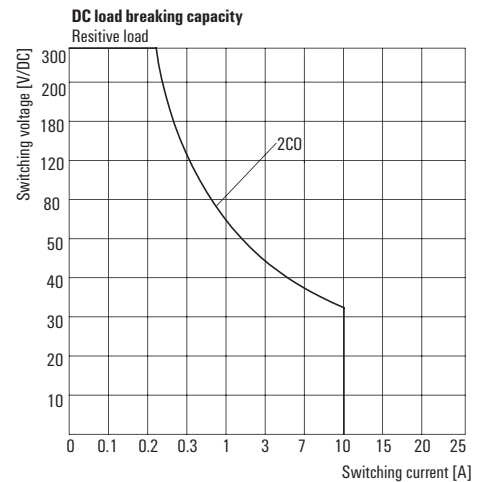
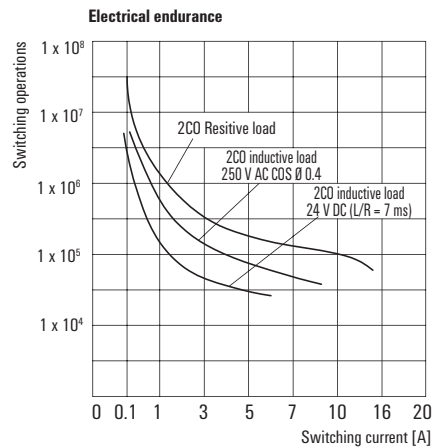
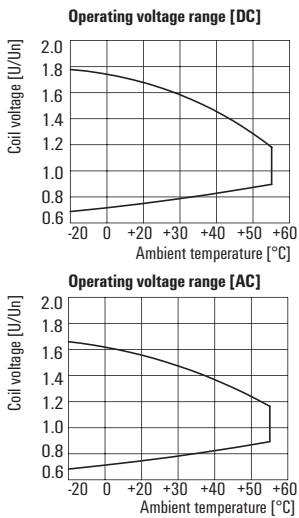

**DRR power relay  
2 CO AC/DC coil**

Type code	DRR			
Type	DRR			
Type of construction	270	2 change over contacts		
Coil voltage	012	12 V DC / 024	24 V DC	
	048	48 V DC / 110	110 V DC	
	220	220 V DC / 524	24 V AC	
	615	115 V AC / 730	230 V AC	
LED indicator	L			

**Ordering data**

	12 V DC 2CO	24 V DC 2CO	48 V DC 2CO	110 V DC 2CO	220 V DC 2CO
<b>Input</b>					
Rated control voltage	12 V DC	24 V DC	48 V DC	110 V DC	220 V DC
Rated current AC / DC	/ 125 mA	/ 55.8 mA	/ 29.2 mA	/ 15 mA	/ 7.6 mA
Power rating	1.5 W	1.5 W	1.5 W	1.5 W	1.5 W
Pull-in/drop-out voltage, typ.	9 V / 1.8 V DC	18 V / 3.6 V DC	36 V / 7.2 V DC	82.5 V / 16.5 V DC	165 V / 33 V DC
Pull-in/drop-out current, typ.					
Status indicator	Green LED, Mechanical	Green LED, Mechanical	Green LED, Mechanical	Green LED, Mechanical	Green LED, Mechanical
<b>Output</b>					
Switch-on delay	< 30 ms	< 30 ms	< 30 ms	< 30 ms	< 30 ms
Switch-off delay	< 20 ms	< 20 ms	< 20 ms	< 20 ms	< 20 ms

Ordering data					
Type	DRR270012L	DRR270024L	DRR270048L	DRR270110L	DRR270220L
Order No.	<b>1133360000</b>	<b>1133370000</b>	<b>1133380000</b>	<b>1133390000</b>	<b>1133400000</b>
Type					
Order No.					
<b>Note</b>					

**Ordering data**

	24 V AC 2CO	115 V AC 2CO	230 V AC 2CO
<b>Input</b>			
Rated control voltage	24 V AC	115 V AC	230 V AC
Rated current AC / DC	130 mA (50 Hz), 116 mA (60 Hz) /	29.8 mA (50 Hz), 25.4 mA (60 Hz) /	14.9 mA (50 Hz), 12.7 mA (60 Hz) /
Power rating	2.7 VA	2.7 VA	2.7 VA
Pull-in/drop-out voltage, typ.	19.2 V / 7.2 V AC	92 V / 34.5 V AC	184 V / 69 V AC
Pull-in/drop-out current, typ.			
Status indicator	red LED, Mechanical	red LED, Mechanical	red LED, Mechanical
<b>Output</b>			
Switch-on delay	< 30 ms	< 30 ms	< 30 ms
Switch-off delay	< 20 ms	< 20 ms	< 20 ms

Ordering data			
Type	DRR270524L	DRR270615L	DRR270730L
Order No.	<b>1133760000</b>	<b>1133780000</b>	<b>1133800000</b>
Type			
Order No.			
<b>Note</b>			

**D-SERIES – relay module**

**DRR power relay**

**3 CO AC/DC coil**

- 2,500 VA switching capacity
- 11-pole relay



**B**

**Circuit diagram**

**DRR310**

AC

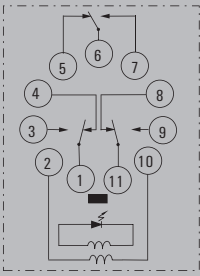

DC

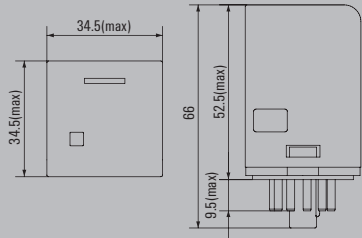
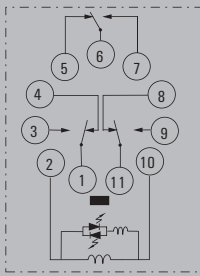

**Technical data**

Output	
Rated switching voltage / Continuous current	250 V AC / 10 A
Max. switching voltage, AC	250 V
Inrush current	
Min. switching power	12 V / 100 mA
DC / AC Switching capacity (resistive), max.	240 W @ 24 V / 2500 VA
Contact material	AgNi
Mechanical service life	10 x 10 <sup>6</sup> switching cycles
Max. switching frequency at rated load	0.1 Hz
Rated data	
Ambient temperature (operational)	-25 °C...55 °C
Storage temperature	-25 °C...55 °C
Humidity	5...85 % rel. humidity, no condensation
Approvals	EAC
Insulation coordination (EN 50178)	
Rated voltage	250 V
Impulse withstand voltage	4 kV (1.2/50 µs)
Dielectric strength input - output	2.5 KV <sub>eff</sub> / 1 min.
Dielectric strength, contact / contact	
Dielectric strength to mounting rail	
Creepage and clearance distance input - output	≥ 3 mm
Overvoltage category	III
Pollution degree	3
Dimensions	
Depth x width x height	mm 66 / 34.5 / 34.5
Plug-in connection	
Depth x width x height	mm 66 / 34.5 / 34.5
Note	

**Applications**

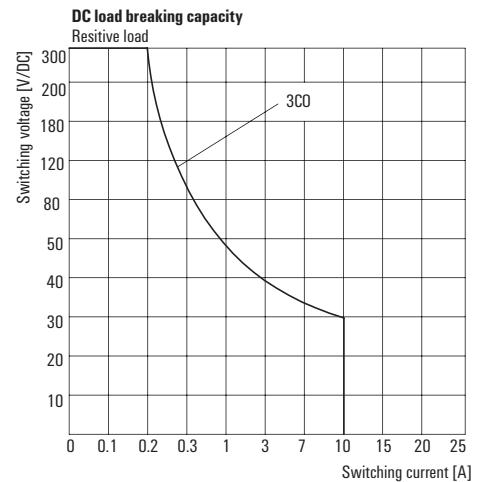
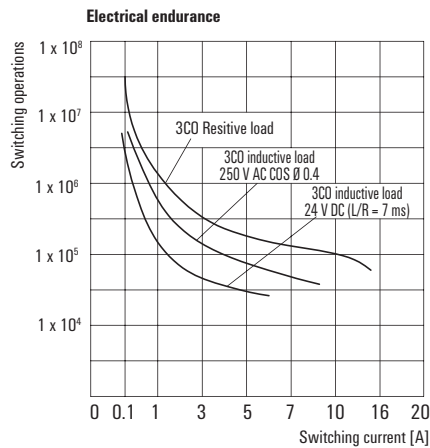
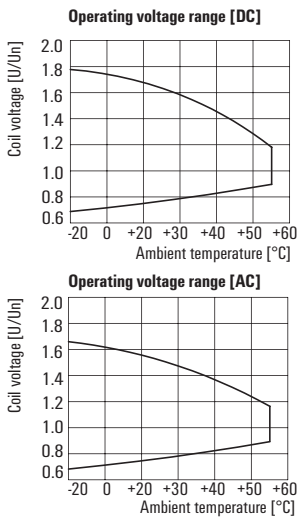

**DRR power relay  
3 CO AC/DC coil**

Type code	DRR			
Type	DRR			
Type of construction	370	3 change over contacts		
Coil voltage	012	12 V DC / 024	24 V DC	
	048	48 V DC / 110	110 V DC	
	220	220 V DC / 524	24 V AC	
	615	115 V AC / 730	230 V AC	
LED indicator	L			

**Ordering data**

	12 V DC 3CO	24 V DC 3CO	48 V DC 3CO	110 V DC 3CO	220 V DC 3CO
<b>Input</b>					
Rated control voltage	12 V DC	24 V DC	48 V DC	110 V DC	220 V DC
Rated current AC / DC	/ 125 mA	/ 55.8 mA	/ 29.2 mA	/ 15 mA	/ 7.6 mA
Power rating	1.5 W	1.5 W	1.5 W	1.5 W	1.5 W
Pull-in/drop-out voltage, typ.	9 V / 1.8 V DC	18 V / 3.6 V DC	36 V / 7.2 V DC	82.5 V / 16.5 V DC	165 V / 33 V DC
Pull-in/drop-out current, typ.					
Status indicator	Green LED, Mechanical	Green LED, Mechanical	Green LED, Mechanical	Green LED, Mechanical	Green LED, Mechanical
<b>Output</b>					
Switch-on delay	< 30 ms	< 30 ms	< 30 ms	< 30 ms	< 30 ms
Switch-off delay	< 20 ms	< 20 ms	< 20 ms	< 20 ms	< 20 ms

Ordering data					
Type	DRR370012L	DRR370024L	DRR370048L	DRR370110L	DRR370220L
Order No.	<b>1133410000</b>	<b>1133420000</b>	<b>1133430000</b>	<b>1133440000</b>	<b>1133560000</b>
Type					
Order No.					
<b>Note</b>					

**Ordering data**

	24 V AC 3CO	115 V AC 3CO	230 V AC 3CO
<b>Input</b>			
Rated control voltage	24 V AC	115 V AC	230 V AC
Rated current AC / DC	130 mA (50 Hz), 116 mA (60 Hz) /	29.8 mA (50 Hz), 25.4 mA (60 Hz) /	14.9 mA (50 Hz), 12.7 mA (60 Hz) /
Power rating	2.7 VA	2.7 VA	2.7 VA
Pull-in/drop-out voltage, typ.	19.2 V / 7.2 V AC	92 V / 34.5 V AC	184 V / 69 V AC
Pull-in/drop-out current, typ.			
Status indicator	red LED, Mechanical	red LED, Mechanical	red LED, Mechanical
<b>Output</b>			
Switch-on delay	< 30 ms	< 30 ms	< 30 ms
Switch-off delay	< 20 ms	< 20 ms	< 20 ms

Ordering data			
Type	DRR370524L	DRR370615L	DRR370730L
Order No.	<b>1133810000</b>	<b>1133820000</b>	<b>1133830000</b>
Type			
Order No.			
<b>Note</b>			

**D-SERIES – DRR relays accessories**

**Accessories for DRR relay**



**Ordering data**

Technical data	
Rated voltage	300 V
Rated current	12 A
Dielectric strength for input - output	4,000 V
Dielectric strength between the contacts	2,500 V
Operating temperature	-40 ... 85 °C
Pollution severity	2
Over voltage class	III
Max. torque	1.0 Nm
Wire cross section	0.5 ... 2.5 mm <sup>2</sup>
Protection class (IEC 61810)	IP20
Weight	50 g
Approvals	CE
Description	
Socket, snaps onto DIN-rail, 8-pin	
Socket, snaps onto DIN-rail, 11-pin	

Type	Qty.	Order No.
SRD ECO 2CO	10	1132810000
SRD ECO 3CO	10	1132820000

**Metal clip**

Description	Order No.
Metal clip for DRR relay sockets	1134160000

Description	Order No.
DRR SOCKET METAL CLIP	1134160000



**Functional modules**

Technical data	Order No.
RC element 6 ... 230 V AC	1174670000
Free-wheel diode 6 ... 230 V DC	1174650000

Technical data	Order No.
RIM 5 6/230 V AC	1174670000
RIM 5 6/230 V DC	1174650000

**Dimensions in mm**

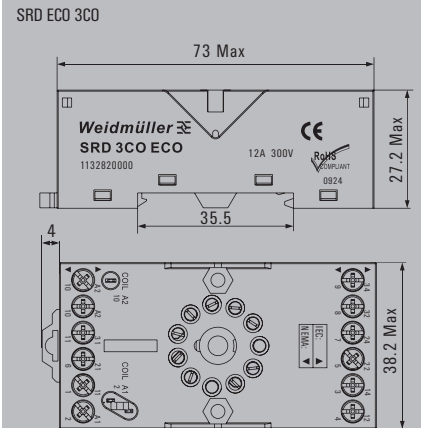
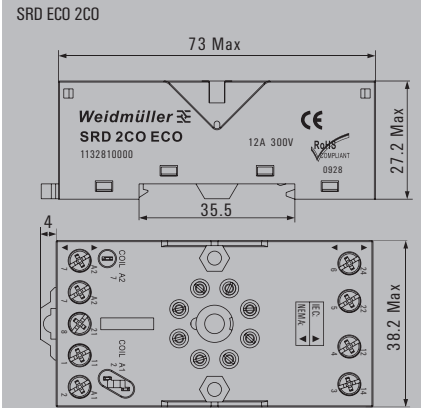





**D-SERIES – relay module**

**PWR high-power relay**

**1 NO AC/DC coil**

- Max. load current: 30 A

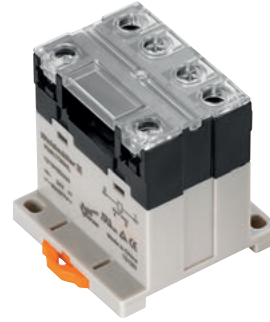

**B**

**Circuit diagram**

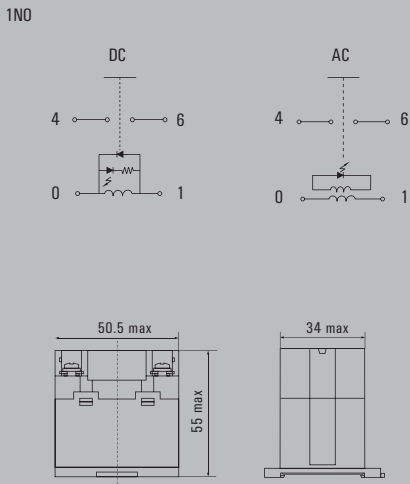

**Technical data**

Output	
Rated switching voltage / Continuous current	277 V AC / 30 A
Max. switching voltage, AC	277 V
Inrush current	
Min. switching power	12 W / 100 mA
DC / AC Switching capacity (resistive), max.	720 W @ 24 V / 8300 VA
Contact material	AgNi
Mechanical service life	
Max. switching frequency at rated load	0.1 Hz
Rated data	
Ambient temperature (operational)	-25 °C...55 °C
Storage temperature	-25 °C...55 °C
Humidity	35...85 % rel. humidity, no condensation
Approvals	cURus; EAC
Insulation coordination (EN 50178)	
Rated voltage	250 V
Impulse withstand voltage	6 kV (1.2/50 µs)
Dielectric strength input - output	4 kV <sub>eff</sub> / 1 min
Dielectric strength, contact / contact	
Dielectric strength to mounting rail	
Creepage and clearance distance input - output	≥ 5.5 mm
Overvoltage category	III
Pollution degree	3
Dimensions	
Depth x width x height	mm 55 / 50.5 / 34
Note	

**Applications**

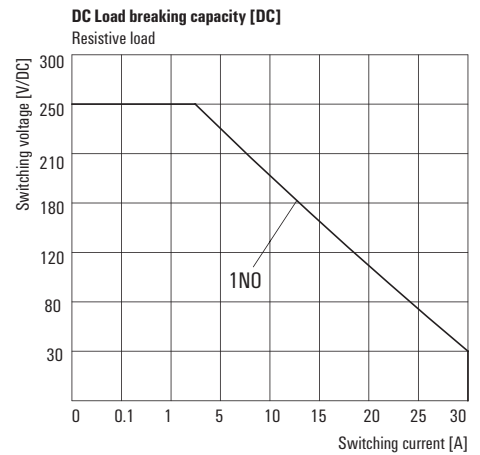
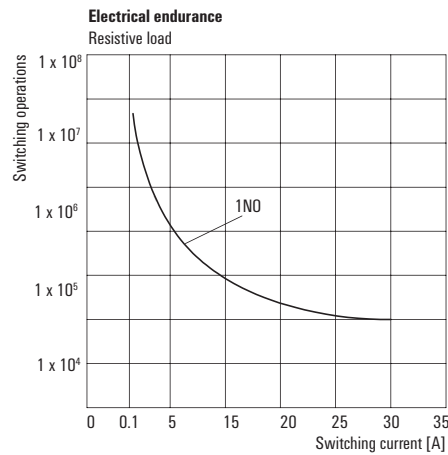
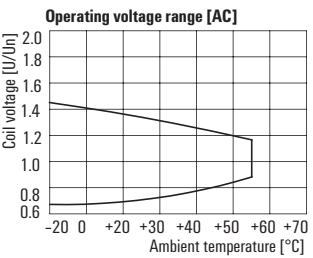
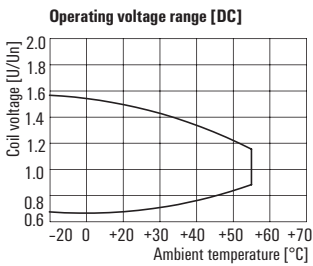

**PWR high-power relay  
1 NO AC/DC coil**

Type code	PWR			
Type	PWR			
Type of construction and mounting	173 1N.O. contact, DIN-rail mounting			
Coil voltage	006	6 V DC / 012	12 V DC	
	024	24 V DC / 048	48 V DC	
	110	110 V DC / 220	220 V DC	
	524	24 V AC / 548	48 V AC	
	615	115 V AC / 730	230 V AC	
	880	380 V AC		
LED indicator	L with LED			

**Ordering data**

	12 V DC 1 NO	24 V DC 1 NO	48 V DC 1 NO	110 V DC 1 NO	220 V DC 1 NO
<b>Input</b>					
Rated control voltage	12 V DC	24 V DC	48 V DC	110 V DC	220 V DC
Rated current AC / DC	/ 160 mA	/ 79.2 mA	/ 39.3 mA	/ 17.3 mA	/ 8.7 mA
Power rating	1.9 W	1.9 W	1.9 W	1.9 W	1.9 W
Pull-in/drop-out voltage, typ.	9 V / 1.8 V DC	18 V / 3.6 V DC	36 V / 7.2 V DC	82.5 V / 16.5 V DC	165 V / 33 V DC
Pull-in/drop-out current, typ.					
Status indicator					
<b>Output</b>					
Switch-on delay	< 20 ms	< 20 ms	< 20 ms	< 20 ms	< 20 ms
Switch-off delay	< 10 ms	< 10 ms	< 10 ms	< 10 ms	< 10 ms

Ordering data						
Din rail installation	Type	PWR173012L	PWR173024L	PWR173048L	PWR173110L	PWR173220L
	Order No.	<b>1219470000</b>	<b>1219480000</b>	<b>1219490000</b>	<b>1219510000</b>	<b>1219520000</b>
	Type					
	Order No.					
<b>Note</b>						

**Ordering data**

	24 V AC 1 NO	48 V AC 1 NO	115 V AC 1 NO	230 V AC 1 NO	380 V AC 1 NO
<b>Input</b>					
Rated control voltage	24 V AC	48 V AC	115 V AC	230 V AC	380 V AC
Rated current AC / DC	87.3 mA /	43.6 mA /	22.1 mA /	11 mA /	6.1 mA /
Power rating	2.5 VA	2.5 VA	2.5 VA	2.5 VA	2.5 VA
Pull-in/drop-out voltage, typ.	18 V / 3.6 V AC	36 V / 7.2 V AC	86.3 V / 17.3 V AC	172.5 V / 34.5 V AC	285 V / 57 V AC
Pull-in/drop-out current, typ.					
Status indicator					
<b>Output</b>					
Switch-on delay	< 20 ms	< 20 ms	< 20 ms	< 20 ms	< 20 ms
Switch-off delay	< 10 ms	< 10 ms	< 10 ms	< 10 ms	< 10 ms

Ordering data						
Din rail installation	Type	PWR173524L	PWR173548L	PWR173615L	PWR173730L	PWR173880L
	Order No.	<b>1219090000</b>	<b>1219120000</b>	<b>1219130000</b>	<b>1219140000</b>	<b>1219150000</b>
	Type					
	Order No.					
<b>Note</b>						

**D-SERIES – relay module**

**PWR high-power relay  
2 NO AC/DC coil**

- Max. load current: 25 A



**B**

**Circuit diagram**

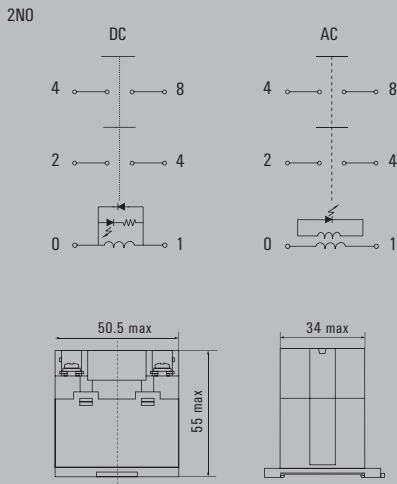

**Technical data**

Output	
Rated switching voltage / Continuous current	277 V AC / 25 A
Max. switching voltage, AC	277 V
Inrush current	
Min. switching power	12 W / 100 mA
DC / AC Switching capacity (resistive), max.	600 W @ 24 V / 6900 VA
Contact material	AgNi
Mechanical service life	
Max. switching frequency at rated load	0.1 Hz
Rated data	
Ambient temperature (operational)	-25 °C...55 °C
Storage temperature	-25 °C...55 °C
Humidity	35...85 % rel. humidity, no condensation
Approvals	cURus; EAC
Insulation coordination (EN 50178)	
Rated voltage	250 V
Impulse withstand voltage	6 kV (1.2/50 µs)
Dielectric strength input - output	4 kV <sub>eff</sub> / 1 min
Dielectric strength, contact / contact	
Dielectric strength to mounting rail	
Creepage and clearance distance input - output	≥ 5.5 mm
Overvoltage category	III
Pollution degree	3
Dimensions	
Depth x width x height	mm 55 / 50.5 / 34
Note	

**Applications**

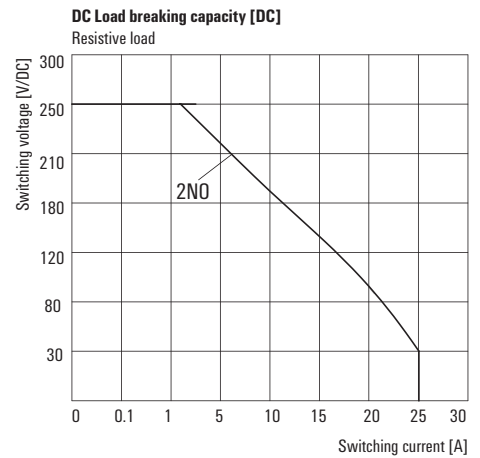
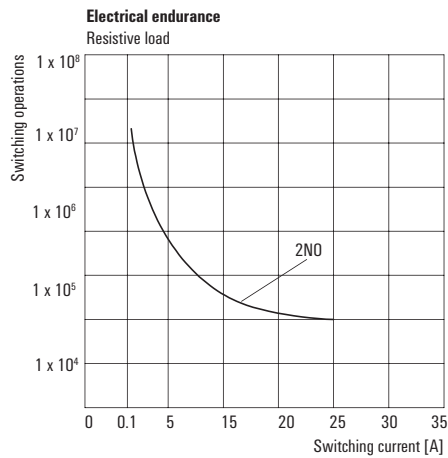
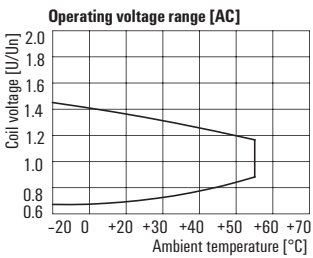
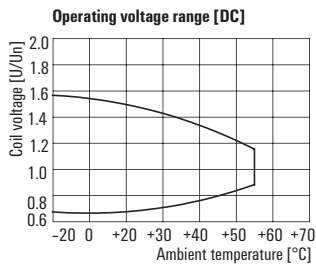

**PWR high-power relay  
2 NO AC/DC coil**

Type code	PWR				
Type	PWR				
Type of construction and mounting	276 2N.O. contact, DIN-rail mounting				
Coil voltage	006	6 V DC / 012	12 V DC		
	024	24 V DC / 048	48 V DC		
	110	110 V DC / 220	220 V DC		
	524	24 V AC / 548	48 V AC		
	615	115 V AC / 730	230 V AC		
	880	380 V AC			
LED indicator	L with LED				

**Ordering data**

	12 V DC 2 NO	24 V DC 2 NO	48 V DC 2 NO	110 V DC 2 NO	220 V DC 2 NO
<b>Input</b>					
Rated control voltage	12 V DC	24 V DC	48 V DC	110 V DC	220 V DC
Rated current AC / DC	/ 160 mA	/ 79.2 mA	/ 39.3 mA	/ 17.3 mA	/ 8.7 mA
Power rating	1.9 W	1.9 W	1.9 W	1.9 W	1.9 W
Pull-in/drop-out voltage, typ.	9 V / 1.8 V DC	18 V / 3.6 V DC	36 V / 7.2 V DC	82.5 V / 16.5 V DC	165 V / 33 V DC
Pull-in/drop-out current, typ.					
Status indicator					
<b>Output</b>					
Switch-on delay	< 30 ms	< 30 ms	< 30 ms	< 30 ms	< 30 ms
Switch-off delay	< 30 ms	< 30 ms	< 30 ms	< 30 ms	< 30 ms

Ordering data						
Din rail installation	Type	PWR276012L	PWR276024L	PWR276048L	PWR276110L	PWR276220L
	Order No.	<b>1219540000</b>	<b>1219550000</b>	<b>1219560000</b>	<b>1219570000</b>	<b>1219580000</b>
	Type					
	Order No.					
<b>Note</b>						

**Ordering data**

	24 V AC 2 NO	48 V AC 2 NO	115 V AC 2 NO	230 V AC 2 NO	380 V AC 2 NO
<b>Input</b>					
Rated control voltage	24 V AC	48 V AC	115 V AC	230 V AC	380 V AC
Rated current AC / DC	87.3 mA /	43.6 mA /	22.1 mA /	11 mA /	6.1 mA /
Power rating	2.5 VA	2.5 VA	2.5 VA	2.5 VA	2.5 VA
Pull-in/drop-out voltage, typ.	18 V / 3.6 V AC	36 V / 7.2 V AC	86.3 V / 17.3 V AC	172.5 V / 34.5 V AC	285 V / 57 V AC
Pull-in/drop-out current, typ.					
Status indicator					
<b>Output</b>					
Switch-on delay	< 30 ms	< 30 ms	< 30 ms	< 30 ms	< 30 ms
Switch-off delay	< 30 ms	< 30 ms	< 30 ms	< 30 ms	< 30 ms

Ordering data						
Din rail installation	Type	PWR276524L	PWR276548L	PWR276615L	PWR276730L	PWR276880L
	Order No.	<b>1219160000</b>	<b>1219170000</b>	<b>1219180000</b>	<b>1219190000</b>	<b>1219220000</b>
	Type					
	Order No.					
<b>Note</b>						

## Coupling modules – the industrial standard



### Relay module with 1 to 4 CO contacts

The RIDER SERIES and its RCI, RCM, RRD and RPW product lines have been successfully integrated into the entire Weidmüller line of relay products. This modular-designed product series formally complies with international standards. A variety of pluggable versions are available with from one to four CO contacts and your choice of connection method.

Our innovative relay bases with PUSH IN connection systems are available for both the RCI/RCL and RCM product lines. PUSH IN technology is safe and easy to use and it allows you to reduce costs with less wiring time. The relay modules are designed for industrial applications and feature sturdy relay pins and industrial-standard pinning. A mechanically operated, stay-down test button is integrated into the design. It enables switching statuses to be simulated during initial commissioning. Additional product features include LED status indicators and free-wheel diodes (DC).

Our relay kits are particularly convenient to use. They include the relay module with status display and the base with ejection lever. The kits are delivered fully assembled and with completely tested functionality. This saves time during assembly and reduces the number of products required.

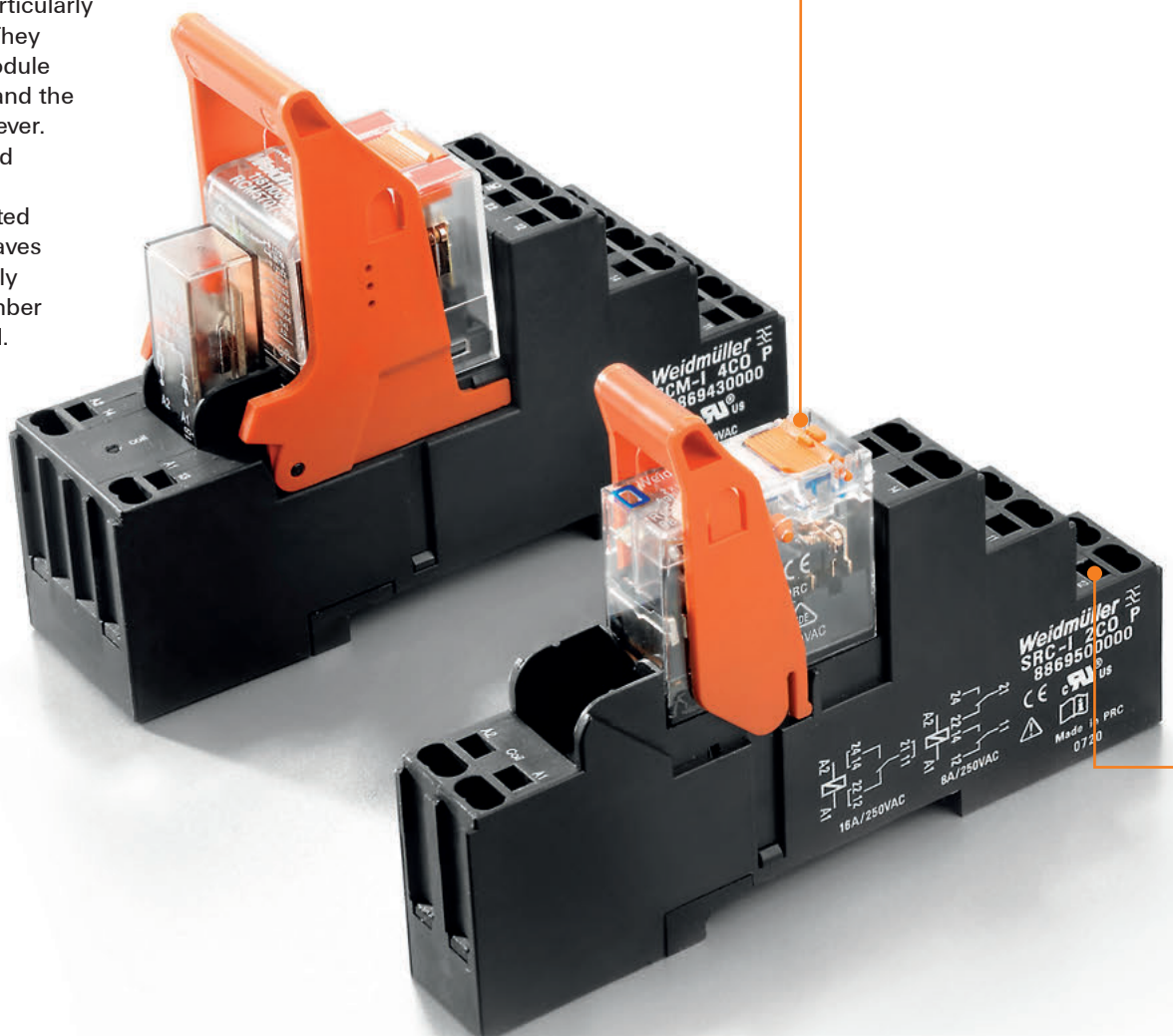

**Simple**

The stay-down test button simplifies commissioning and service work.



**Customised**

Suppressor circuitry and LED can be integrated into a relay module or as a pluggable module at the base.

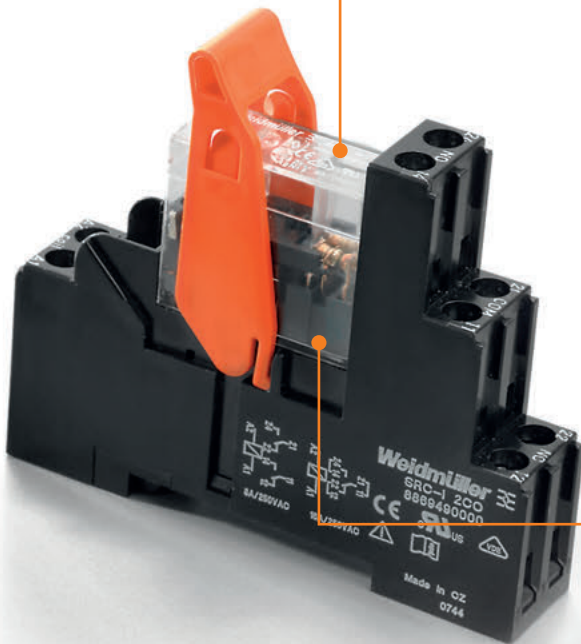

**Safe**

The heavy-duty industrial pins ensure a reliable connection.

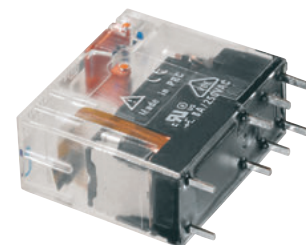

**Saves time**

No-screw PUSH IN connections and cross-connections can reduce wiring time by more than 50 %.

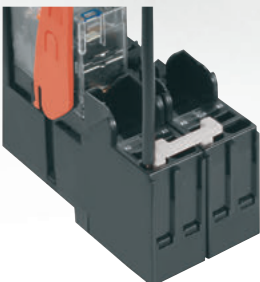

**RIDERSERIES relay modules**

**RCI KIT with screw connection**

**1 CO contact**

- 4000 VA switching capacity
- Stable plug-in connections
- LED (AC red / DC green) integrated in relay
- Protective suppressor circuit for DC coil
- Optional test button with latching function and inspection window
- Identification of coils (AC red / DC blue)



**B**

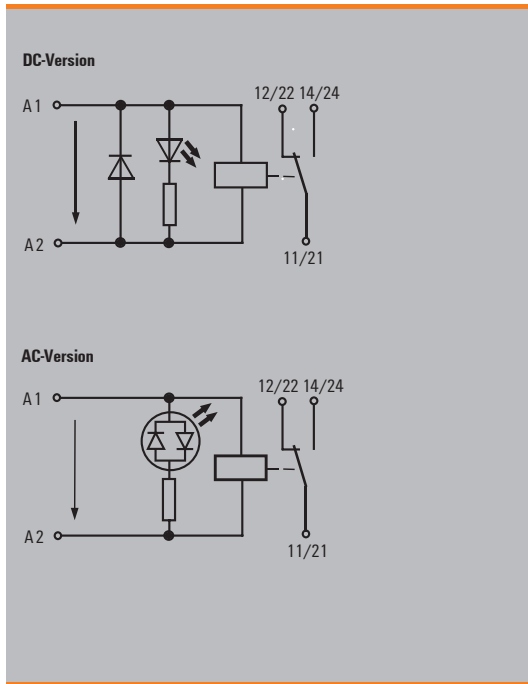

**Technical data**

Output	
Rated switching voltage / Continuous current	250 V AC / 16 A <sup>1)</sup>
Max. switching voltage, AC	400 V
Inrush current	30 A / 4 s
Min. switching power	100 mA / 5 V, 10 V / 10 mA, 24 V / 1 mA
DC / AC Switching capacity (resistive), max.	384 W @ 24 V / 4000 VA
Contact material	AgNi 90/10
Mechanical service life	AC coil 5 x 10 <sup>6</sup> Switch. cycles, DC coil 10 x 10 <sup>6</sup> Switch. cycles
Max. switching frequency at rated load	0.1 Hz
Rated data	
Ambient temperature (operational)	-40 °C...70 °C
Storage temperature	-40 °C...70 °C
Humidity	40 °C / 93 % rel. humidity, no condensation
Approvals	CE, EAC, GL
Insulation coordination (EN 50178)	
Rated voltage	250 V
Impulse withstand voltage	5 kV (1.2/50 µs)
Dielectric strength input - output	5 kV <sub>eff</sub> / 1min
Dielectric strength, contact / contact	
Dielectric strength to mounting rail	
Creepage and clearance distance input - output	≥ 8 mm
Overvoltage category	III
Pollution degree	2
Dimensions	
Clamping range (nominal / min. / max.)	mm <sup>2</sup> 2.5 / 0.5 / 2.5
Depth x width x height	mm 70 / 15.5 / 77
Screw connection	
Clamping range (nominal / min. / max.)	mm <sup>2</sup> 2.5 / 0.5 / 2.5
Depth x width x height	mm 70 / 15.5 / 77
<b>Note</b>	1) For full continuous current (16 A), relay connections 11 - 21, 12 - 22 and 14 - 24 must be bridged.

**Ordering data**

Input		24 V DC 1CO	24 V AC 1CO	115 V AC 1CO	230 V AC 1CO
Rated control voltage		24 V DC	24 V AC	115 V AC	230 V AC
Rated current AC / DC		/ 16.7 mA	31.6 mA /	7 mA /	3.5 mA /
Power rating		420 mW	0.75 VA	0.8 VA	0.8 VA
Pull-in/drop-out voltage, typ.		16.8 V / 2.4 V DC	18 V / 3.6 V AC	86.3 V / 17.3 V AC	172.5 V / 34.5 V AC
Status indicator		Green LED, Mechanical	red LED, Mechanical	red LED, Mechanical	red LED, Mechanical
Protective circuit		Integrated free-wheel diode			
Output					
Switch-on delay		≤ 8 ms	≤ 8 ms	≤ 8 ms	≤ 8 ms
Switch-off delay		≤ 6 ms	≤ 6 ms	≤ 6 ms	≤ 6 ms
Ordering data					
w. test button	Type	RCIKIT 24VDC 1CO LD/PB	RCIKIT 24VAC 1CO LD/PB	RCIKIT 115VAC 1CO LD/PB	RCIKIT 230VAC 1CO LD/PB
	Order No.	8881580000	8881590000	8897060000	8881600000
w.o. test button	Type	RCIKIT 24VDC 1CO LED	RCIKIT 24VAC 1CO LED	RCIKIT 115VAC 1CO LD	RCIKIT 230VAC 1CO LED
	Order No.	8871000000	8871010000	8897090000	8871020000
Ordering data					
Spare relay	Type	w. test button    w.o. test button	w. test button    w.o. test button	w. test button    w.o. test button	w. test button    w.o. test button
	Order No.	RCI374AC4    RCI314AC4	RCI374R24    RCI314R24	RCI374S15    RCI314S15	RCI374T30    RCI314T30
		8870250000    8870100000	8870280000    8870130000	8870290000    8870140000	8870300000    8870150000
<b>Note</b>					

**RCI-KITP with PUSH IN connection**

**1 CO contact**

- 4000 VA switching capacity
- Stable plug-in connections
- LED (AC red / DC green) integrated in relay
- Protective suppressor circuit for DC coil
- Optional test button with latching function and inspection window
- Identification of coils (AC red / DC blue)

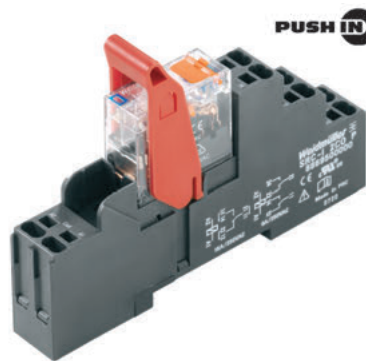

**DC-Version**

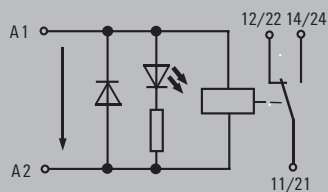

**AC-Version**

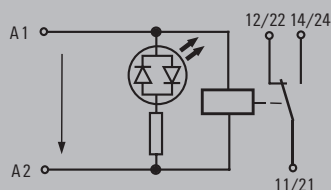

**Technical data**

Output	
Rated switching voltage / Continuous current	250 V AC / 16 A <sup>1)</sup>
Max. switching voltage, AC	400 V
Inrush current	30 A / 4 s
Min. switching power	100 mA / 5 V, 10 V / 10 mA, 24 V / 1 mA
DC / AC Switching capacity (resistive), max.	384 W @ 24 V / 4000 VA
Contact material	AgNi 90/10
Mechanical service life	AC coil 5 x 10 <sup>6</sup> Switch. cycles, DC coil 10 x 10 <sup>6</sup> Switch. cycles
Max. switching frequency at rated load	0.1 Hz
Rated data	
Ambient temperature (operational)	-40 °C...70 °C
Storage temperature	-40 °C...70 °C
Humidity	40 °C / 93 % rel. humidity, no condensation
Approvals	CE, EAC, GL
Insulation coordination (EN 50178)	
Rated voltage	250 V
Impulse withstand voltage	5 kV (1.2/50 µs)
Dielectric strength input - output	5 kV <sub>eff</sub> / 1min
Dielectric strength, contact / contact	
Dielectric strength to mounting rail	
Creepage and clearance distance input - output	≥ 8 mm
Overvoltage category	III
Pollution degree	2
Dimensions	
<b>PUSH IN spring connection</b>	
Clamping range (nominal / min. / max.)	mm <sup>2</sup> 1.5 / 0.75 / 1.5
Depth x width x height	mm 70 / 15.5 / 98
Note	
1) For full continuous current (16 A), relay connections 11 - 21, 12 - 22 and 14 - 24 must be bridged.	

**Ordering data**

	24 V DC 1CO	24 V AC 1CO	115 V AC 1CO	230 V AC 1CO
<b>Input</b>				
Rated control voltage	24 V DC	24 V AC	115 V AC	230 V AC
Rated current AC / DC	/ 16.7 mA	31.6 mA /	7 mA /	3.5 mA /
Power rating	420 mW	0.75 VA	0.8 VA	0.8 VA
Pull-in/drop-out voltage, typ.	16.8 V / 2.4 V DC	18 V / 3.6 V AC	86.3 V / 17.3 V AC	172.5 V / 34.5 V AC
Status indicator	Green LED, Mechanical	red LED, Mechanical	red LED, Mechanical	red LED, Mechanical
Protective circuit	Integrated free-wheel diode			
<b>Output</b>				
Switch-on delay	≤ 8 ms	≤ 8 ms	≤ 8 ms	≤ 8 ms
Switch-off delay	≤ 6 ms	≤ 6 ms	≤ 6 ms	≤ 6 ms

Ordering data					
w. test button	Type	RCIKITP 24VDC 1CO LD/PB	RCIKITP 24VAC 1CO LD/PB	RCIKITP115VAC 1CO LD/PB	RCIKITP230VAC 1CO LD/PB
	Order No.	8897190000	8897200000	8897210000	8897220000
w.o. test button	Type	RCIKITP 24VDC 1CO LD	RCIKITP 24VAC 1CO LD	RCIKITP 115VAC 1CO LD	RCIKITP 230VAC 1CO LD
	Order No.	8897110000	8897120000	8897130000	8897140000

Ordering data		w. test button		w.o. test button		w. test button		w.o. test button	
<b>Spare relay</b>	Type	RCI374R24	RCI314R24	RCI374R24	RCI314R24	RCI374S15	RCI314S15	RCI374T30	RCI314T30
	Order No.	8870280000	8870130000	8870280000	8870130000	8870290000	8870140000	8870300000	8870150000

Note	



**RIDERSERIES – RCI KIT 1 CO accessories**

**Accessories for RCI KIT relay modules, 1 CO**

**Plug-in module with PUSH IN connection**



**Plug-in module with screw connection**

Standard height

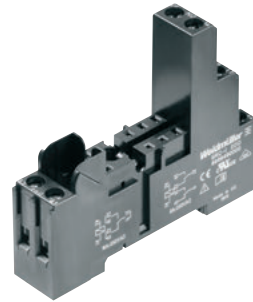

**Plug-in module with screw connection**

Low height

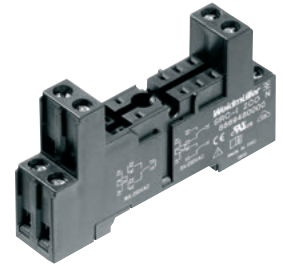

**Technical data**

Rated current	2 x 12 A*)
Rated voltage	240 V AC
Dielectric strength of coil contacts	4000 V <sub>eff</sub>
Ambient temperature (operational)	-25 °C...+85 °C
Protection class (IEC 61810)	IP 20
Stripping length	12 mm
Approvals	VDE, cURus, CSA
Connection cross-section	
- Solid-core wire	1 x 1.5 mm <sup>2</sup> / 2 x 1.0 mm <sup>2</sup>
- Stranded wire	1 x 1.5 mm <sup>2</sup> / 2 x 1.0 mm <sup>2</sup>
- with ferrule	1 x 1.0 mm <sup>2</sup> / 2 x 0.75 mm <sup>2</sup>
Rated torque acc. to IEC 61984 for screw connection	

Rated current	2 x 12 A*)
Rated voltage	240 V AC
Dielectric strength of coil contacts	> 3000 V <sub>eff</sub>
Ambient temperature (operational)	-25 °C...+85 °C
Protection class (IEC 61810)	IP 20
Stripping length	8 mm
Approvals	VDE, cURus, CSA
Connection cross-section	
- Solid-core wire	2 x 2.5 mm <sup>2</sup>
- Stranded wire	2 x 2.5 mm <sup>2</sup>
- with ferrule	2 x 1.5 mm <sup>2</sup>
Rated torque acc. to IEC 61984 for screw connection	0.5 Nm / max. 0.7 Nm

Rated current	2 x 12 A*)
Rated voltage	240 V AC
Dielectric strength of coil contacts	> 3000 V <sub>eff</sub>
Ambient temperature (operational)	-25 °C...+85 °C
Protection class (IEC 61810)	IP 20
Stripping length	8 mm
Approvals	VDE, cURus, CSA
Connection cross-section	
- Solid-core wire	2 x 2.5 mm <sup>2</sup>
- Stranded wire	2 x 2.5 mm <sup>2</sup>
- with ferrule	2 x 1.5 mm <sup>2</sup>
Rated torque acc. to IEC 61984 for screw connection	0.5 Nm / max. 0.7 Nm

Rated current	2 x 12 A*)
Rated voltage	240 V AC
Dielectric strength of coil contacts	> 3000 V <sub>eff</sub>
Ambient temperature (operational)	-25 °C...+85 °C
Protection class (IEC 61810)	IP 20
Stripping length	8 mm
Approvals	VDE, cURus, CSA
Connection cross-section	
- Solid-core wire	2 x 2.5 mm <sup>2</sup>
- Stranded wire	2 x 2.5 mm <sup>2</sup>
- with ferrule	2 x 1.5 mm <sup>2</sup>
Rated torque acc. to IEC 61984 for screw connection	0.5 Nm / max. 0.7 Nm

\* For 1-pole relay modules (16 A), the following terminals must be connected: 11 with 21, 12 with 22, and 14 with 24.

**Ordering data**

Description	Type	Qty.	Order No.
Plug-in module, snaps onto TS 35 DIN mounting rail, 2-pole	SRC-I 2CO P		8869500000

Type	Qty.	Order No.
SRC-I 2CO		8869490000

Type	Qty.	Order No.
SRC-I 2CO		8869490000

Type	Qty.	Order No.
SRC-I 2CO N		8869480000

**Accessories**

Description	Type	Qty.	Order No.
Plastic retaining clip	SRC-I CLIP HP	10	8869510000
Metal retaining clip	SRC-I CLIP HM RCI	20	1132090000
Label	SRC-I MARK	10	8869530000
MultiCard 6x15 mm	ESG 6/15 K MC	200	1880100000
	NEUTR. WS		
	SRC-I QV P		8870840000

Type	Qty.	Order No.
SRC-I CLIP HP	10	8869510000
SRC-I CLIP HM RCI	20	1132090000
SRC-I MARK	10	8869530000
ESG 6/15 K MC	200	1880100000
NEUTR. WS		
SRC-I QV P		8870840000

Type	Qty.	Order No.
SRC-I CLIP HP	10	8869510000
SRC-I CLIP HM RCI	20	1132090000
SRC-I MARK	10	8869530000
ESG 6/15 K MC	200	1880100000
NEUTR. WS		
SRC-I QV S		1132070000

Type	Qty.	Order No.
SRC-I CLIP HP	10	8869510000
SRC-I CLIP HM RCI	20	1132090000
SRC-I MARK	10	8869530000
ESG 6/15 K MC	200	1880100000
NEUTR. WS		
SRC-I QV S		1132070000

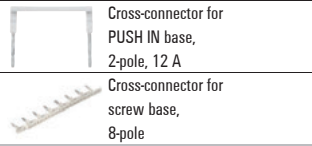

**Dimensions**

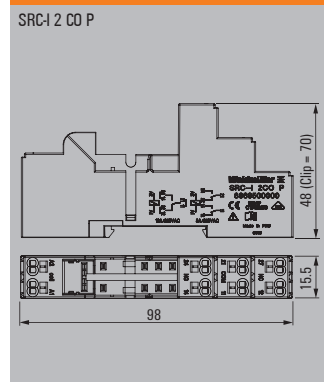

**Dimensions**

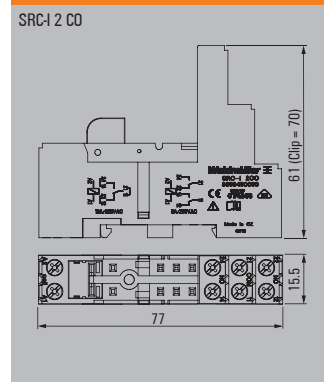

**Dimensions**

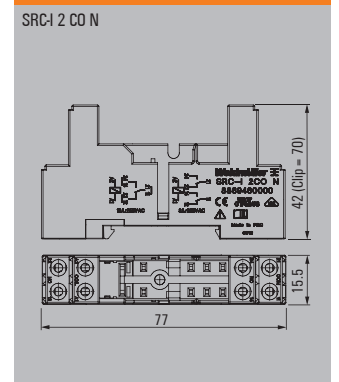

Dimensions in mm

**LED and protective modules for the SRC-I plug-in frame**

Simply plug into the base module; reverse-connect protection. Connect parallel to coil.

**Ordering data**

Description
Free Wheel diode 1N4007
Resistor 100 kΩ 1 Watt
RC-element 6 ... 60 V AC; 470 Ω / 220 nF
RC-element 110 ... 230 V AC; 4.7 Ω / 10 nF
Varistor protection 24 V; S07K30
Varistor protection 110 V; S07K130
Varistor protection 230 V; S07K275
LED
LED 6 ... 24 V DC with free wheel diode
LED 24 ... 60 V DC with free wheel diode
LED 110 ... 230 V DC with free wheel diode
LED 6 ... 24 V DC / V AC
LED 24 ... 60 V DC / V AC
LED 110 ... 230 V DC / V AC

Type	Qty.	Order No.	Order No.
RIM-I 1 6/230V	10	<b>8869580000</b>	
RIM-I 1 R 110/230V	10	<b>8870830000</b>	
RIM-I 3 6/60VAC	10	<b>8869770000</b>	
RIM-I 3 110/230VAC	10	<b>8869790000</b>	
RIM-I 4 24VUC	10	<b>8869710000</b>	
RIM-I 4 110VUC	10	<b>8869730000</b>	
RIM-I 4 230VUC	10	<b>8869750000</b>	
		red	green
RIM-I 2 6/24VDC	10	<b>8869590000</b>	<b>8869600000</b>
RIM-I 2 24/60VDC	10	<b>8869670000</b>	<b>8869680000</b>
RIM-I 2 110/230VDC	10	<b>8869690000</b>	<b>8869700000</b>
RIM-I 3 6/24VUC	10	<b>8869630000</b>	<b>8869640000</b>
RIM-I 3 24/60VUC	10	<b>8869610000</b>	<b>8869620000</b>
RIM-I 3 110/230VUC	10	<b>8869650000</b>	<b>8869660000</b>

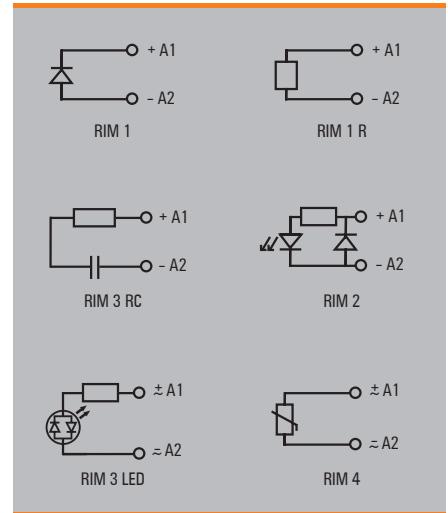

**Warnings and notes on usage**

Handling the PUSH IN connection

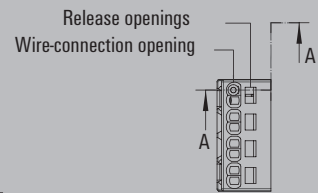
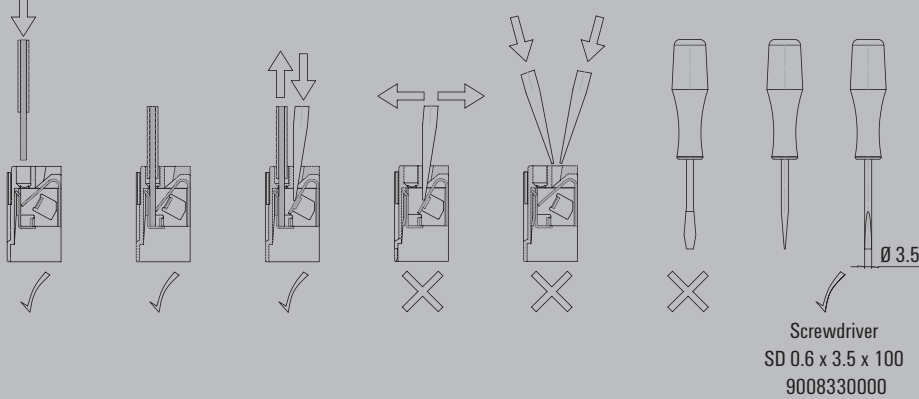

Cross-connector mounting for PUSH IN base

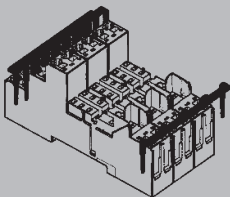

If more than two poles need to be connected with stacked cross-connector ridges, then the lower ridge must be stripped and shortened to the proper length so it will fit.

Cross-connector mounting for screw base

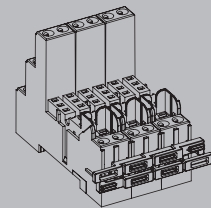



## RCI-KITP with PUSH IN connection

## 2 CO contacts

- 2000 VA switching capacity
- Stable plug-in connections
- LED (AC red / DC green) integrated in relay
- Protective suppressor circuit for DC coil
- Optional test button with latching function and inspection window
- Identification of coils (AC red / DC blue)

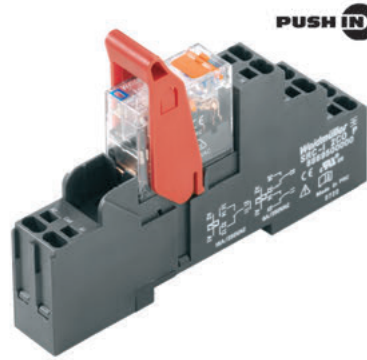

## Version DC

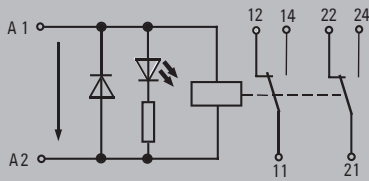

## Version AC

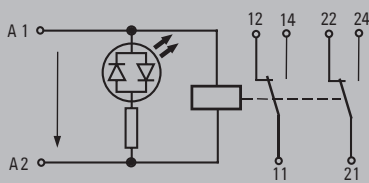

## Technical data

Output	
Rated switching voltage / Continuous current	250 V AC / 8 A
Max. switching voltage, AC	400 V
Inrush current	15 A / 4 s
Min. switching power	100 mA / 5 V, 10 V / 10 mA, 24 V / 1 mA
DC / AC Switching capacity (resistive), max.	192 W @ 24 V / 2000 VA
Contact material	AgNi 90/10
Mechanical service life	AC coil 5 x 10 <sup>6</sup> Switch. cycles, DC coil 10 x 10 <sup>6</sup> Switch. cycles
Max. switching frequency at rated load	0.1 Hz
Rated data	
Ambient temperature (operational)	-40 °C...70 °C
Storage temperature	-40 °C...70 °C
Humidity	40 °C / 93 % rel. humidity, no condensation
Approvals	CE, EAC, GL
Insulation coordination (EN 50178)	
Rated voltage	250 V
Impulse withstand voltage	5 kV (1.2/50 µs)
Dielectric strength input - output	5 kV <sub>eff</sub> / 1min
Dielectric strength, contact / contact	
Dielectric strength to mounting rail	
Creepage and clearance distance input - output	≥ 8 mm
Overvoltage category	III
Pollution degree	2
Dimensions	
Clamping range (nominal / min. / max.)	mm <sup>2</sup> 1.5 / 0.75 / 1.5
Depth x width x height	mm 70 / 15.5 / 98
Note	

## Ordering data

Input		24 V DC 2CO	24 V AC 2CO	115 V AC 2CO	230 V AC 2CO	
Rated control voltage		24 V DC	24 V AC	115 V AC	230 V AC	
Rated current AC / DC		/ 16.7 mA	31.6 mA /	7 mA /	3.5 mA /	
Power rating		420 mW	0.75 VA	0.8 VA	0.8 VA	
Pull-in/drop-out voltage, typ.		16.8 V / 2.4 V DC	18 V / 3.6 V AC	86.3 V / 17.3 V AC	172.5 V / 34.5 V AC	
Status indicator		Green LED, Mechanical	red LED, Mechanical	red LED, Mechanical	red LED, Mechanical	
Protective circuit		Integrated free-wheel diode				
Output						
Switch-on delay		≤ 10 ms	≤ 10 ms	≤ 10 ms	≤ 10 ms	
Switch-off delay		≤ 6 ms	≤ 6 ms	≤ 6 ms	≤ 6 ms	
Ordering data						
w. test button	Type	RCIKITP 24VDC 2CO LD/PB	RCIKITP 24VAC 2CO LD/PB	RCIKITP115VAC 2CO LD/PB	RCIKITP230VAC 2CO LD/PB	
	Order No.	8897230000	8897240000	8897250000	8897260000	
w.o. test button	Type	RCIKITP 24VDC 2CO LD	RCIKITP 24VAC 2CO LD	RCIKITP 115VAC 2CO LD	RCIKITP 230VAC 2CO LD	
	Order No.	8897150000	8897160000	8897170000	8897180000	
Ordering data						
Spare relay	Type	w. test button	w. test button	w. test button	w. test button	
	Order No.	RCI484AC4	RCI424AC4	RCI484R24	RCI424R24	
		8870320000	8870180000	8870350000	8870210000	
				RCI484S15	RCI424S15	
				8870360000	8870220000	
					RCI484T30	RCI424T30
					8870370000	8870230000
Note						

**RIDERSERIES – RCI KIT 2 CO accessories**

**Accessories for RCI KIT relay modules, 2 CO**

**Plug-in module with PUSH IN connection**

**Plug-in module with screw connection**

**Plug-in module with screw connection**

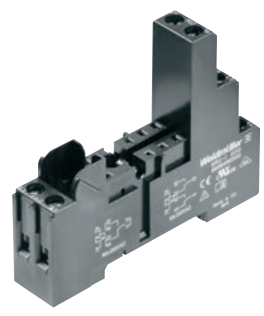
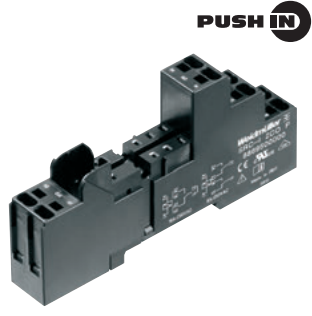

**Technical data**

Rated current	2 x 12 A
Rated voltage	240 V AC
Dielectric strength of coil contacts	4000 V <sub>eff</sub>
Ambient temperature (operational)	-25 °C...+85 °C
Protection class (IEC 61810)	IP 20
Stripping length	12 mm
Approvals	VDE, cURus, CSA
Connection cross-section	
- Solid-core wire	1 x 1.5 mm <sup>2</sup> / 2 x 1.0 mm <sup>2</sup>
- Stranded wire	1 x 1.5 mm <sup>2</sup> / 2 x 1.0 mm <sup>2</sup>
- with ferrule	1 x 1.0 mm <sup>2</sup> / 2 x 0.75 mm <sup>2</sup>
Rated torque acc. to IEC 61984 for screw connection	

Rated current	2 x 12 A
Rated voltage	240 V AC
Dielectric strength of coil contacts	> 3000 V <sub>eff</sub>
Ambient temperature (operational)	-25 °C...+85 °C
Protection class (IEC 61810)	IP 20
Stripping length	8 mm
Approvals	VDE, cURus, CSA
Connection cross-section	
- Solid-core wire	2 x 2.5 mm <sup>2</sup>
- Stranded wire	2 x 2.5 mm <sup>2</sup>
- with ferrule	2 x 1.5 mm <sup>2</sup>
Rated torque acc. to IEC 61984 for screw connection	0.5 Nm / max. 0.7 Nm

Rated current	2 x 12 A
Rated voltage	240 V AC
Dielectric strength of coil contacts	> 3000 V <sub>eff</sub>
Ambient temperature (operational)	-25 °C...+85 °C
Protection class (IEC 61810)	IP 20
Stripping length	8 mm
Approvals	VDE, cURus, CSA
Connection cross-section	
- Solid-core wire	2 x 2.5 mm <sup>2</sup>
- Stranded wire	2 x 2.5 mm <sup>2</sup>
- with ferrule	2 x 1.5 mm <sup>2</sup>
Rated torque acc. to IEC 61984 for screw connection	0.5 Nm / max. 0.7 Nm

Rated current	2 x 12 A
Rated voltage	240 V AC
Dielectric strength of coil contacts	> 3000 V <sub>eff</sub>
Ambient temperature (operational)	-25 °C...+85 °C
Protection class (IEC 61810)	IP 20
Stripping length	8 mm
Approvals	VDE, cURus, CSA
Connection cross-section	
- Solid-core wire	2 x 2.5 mm <sup>2</sup>
- Stranded wire	2 x 2.5 mm <sup>2</sup>
- with ferrule	2 x 1.5 mm <sup>2</sup>
Rated torque acc. to IEC 61984 for screw connection	0.5 Nm / max. 0.7 Nm

**Ordering data**

Description
Plug-in module, snaps onto TS35 DIN mounting rail, 2-pole

Type	Qty.	Order No.
SRC-I 2CO P		8869500000

Type	Qty.	Order No.
SRC-I 2CO		8869490000

Type	Qty.	Order No.
SRC-I 2CO N		8869480000

**Accessories**

Description
Plastic retaining clip
Metal retaining clip
Label
MultiCard 6x15 mm

Type	Qty.	Order No.
SRC-I CLIP HP	10	8869510000
SRC-I CLIP HM RCI	20	1132090000
SRC-I MARK	10	8869530000
ESG 6/15 K MC	200	1880100000
NEUTR. WS		
SRC-I QV P		8870840000

Type	Qty.	Order No.
SRC-I CLIP HP	10	8869510000
SRC-I CLIP HM RCI	20	1132090000
SRC-I MARK	10	8869530000
ESG 6/15 K MC	200	1880100000
NEUTR. WS		
SRC-I QV S		1132070000

Type	Qty.	Order No.
SRC-I CLIP HP	10	8869510000
SRC-I CLIP HM RCI	20	1132090000
SRC-I MARK	10	8869530000
ESG 6/15 K MC	200	1880100000
NEUTR. WS		
SRC-I QV S		1132070000

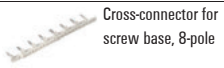
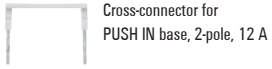

**Dimensions**

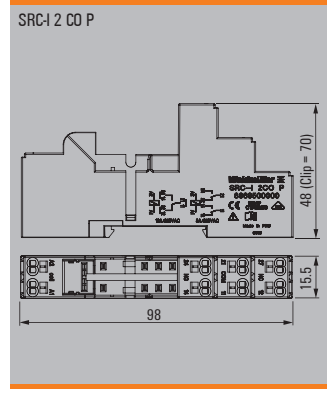

**Dimensions**

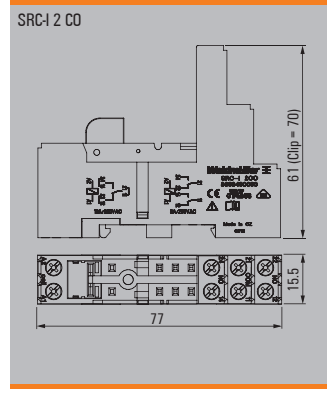

**Dimensions**

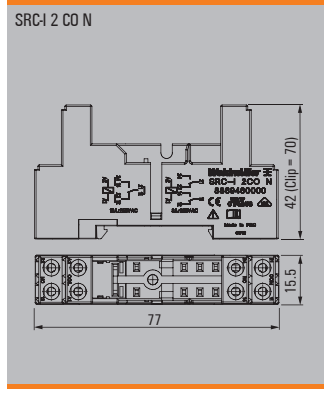

Dimensions in mm

**LED and protective modules for the SRC-I plug-in frame**

Simply plug into the base module; reverse-connect protection. Connect parallel to coil.

**Ordering data**

Description
Free Wheel diode 1N4007
Resistor 100 kΩ 1 Watt
RC-element 6 ... 60 V AC; 470 Ω / 220 nF
RC-element 110 ... 230 V AC; 4.7 Ω / 10 nF
Varistor protection 24 V; S07K30
Varistor protection 110 V; S07K130
Varistor protection 230 V; S07K275
LED
LED 6 ... 24 V DC with free wheel diode
LED 24 ... 60 V DC with free wheel diode
LED 110 ... 230 V DC with free wheel diode
LED 6 ... 24 V DC / V AC
LED 24 ... 60 V DC / V AC
LED 110 ... 230 V DC / V AC

Type	Qty.	Order No.	Order No.
RIM-I 1 6/230V	10	<b>8869580000</b>	
RIM-I 1 R 110/230V	10	<b>8870830000</b>	
RIM-I 3 6/60VAC	10	<b>8869770000</b>	
RIM-I 3 110/230VAC	10	<b>8869790000</b>	
RIM-I 4 24VUC	10	<b>8869710000</b>	
RIM-I 4 110VUC	10	<b>8869730000</b>	
RIM-I 4 230VUC	10	<b>8869750000</b>	
		<b>red</b>	<b>green</b>
RIM-I 2 6/24VDC	10	<b>8869590000</b>	<b>8869600000</b>
RIM-I 2 24/60VDC	10	<b>8869670000</b>	<b>8869680000</b>
RIM-I 2 110/230VDC	10	<b>8869690000</b>	<b>8869700000</b>
RIM-I 3 6/24VUC	10	<b>8869630000</b>	<b>8869640000</b>
RIM-I 3 24/60VUC	10	<b>8869610000</b>	<b>8869620000</b>
RIM-I 3 110/230VUC	10	<b>8869650000</b>	<b>8869660000</b>

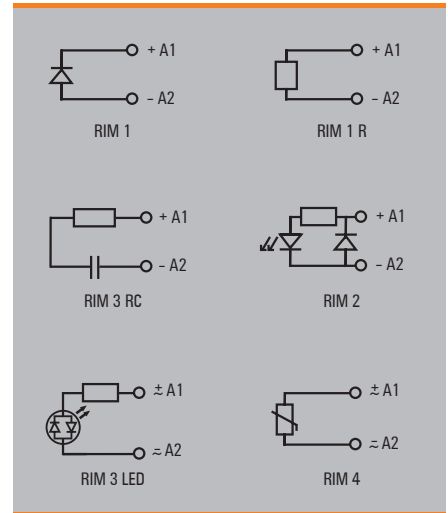

**Warnings and notes on usage**

Handling the PUSH IN connection

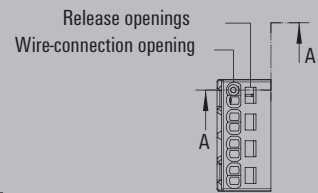
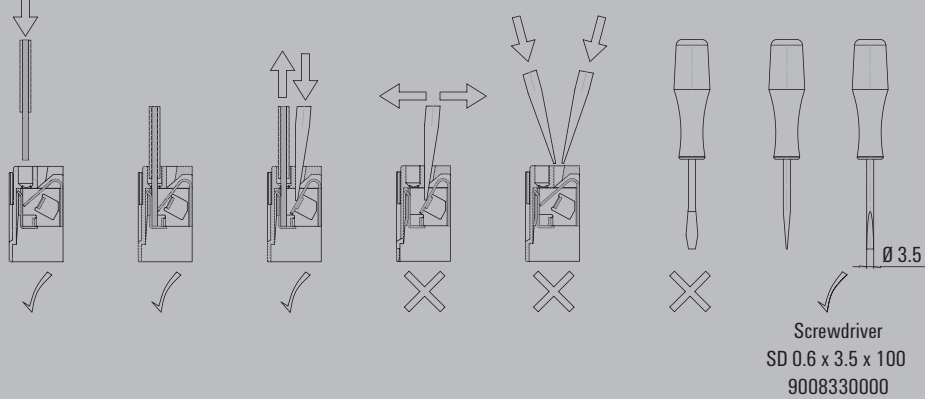

Cross-connector mounting for PUSH IN base

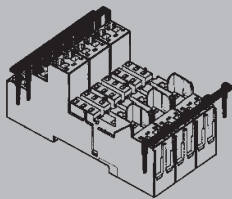

If more than two poles need to be connected with stacked cross-connector ridges, then the lower ridge must be stripped and shortened to the proper length so it will fit.

Cross-connector mounting for screw base

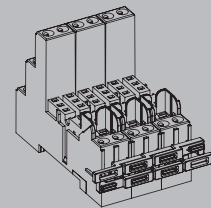

**RIDERSERIES relay modules**

**RCI relay**

**1 CO contact AC/DC coil**

- 4000 VA switching capacity
- Stable plug-in connections
- Optional test button with latching function and inspection window
- Optional status indicator (AC red / DC green)
- Optional protective suppressor circuit
- Identification of coils (AC red / DC blue)



**B**

**Circuit diagram**

View on solder pins  
dimensions in mm

1 C/O changeover contacts

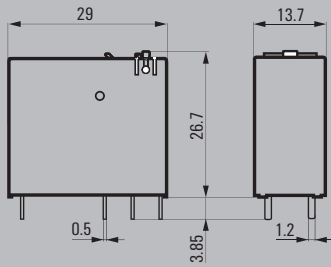
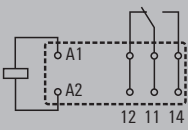

**Technical data**

Output	
Rated switching voltage / Continuous current	240 V AC / 16 A
Max. switching voltage, AC	400 V
Inrush current	30 A / 4 s
Min. switching power	100 mA / 5 V, 10 V / 10 mA, 24 V / 1 mA
DC / AC Switching capacity (resistive), max.	384 W @ 24 V / 4000 VA
Contact material	AgNi 90/10
Mechanical service life	AC coil 5 x 10 <sup>6</sup> Switch. cycles, DC coil 10 x 10 <sup>6</sup> Switch. cycles
Max. switching frequency at rated load	0.1 Hz
Rated data	
Ambient temperature (operational)	-40 °C...70 °C
Storage temperature	-40 °C...85 °C
Humidity	40 °C / 93 % rel. humidity, no condensation
Approvals	CSA; cURus; EAC; VDE
Insulation coordination (EN 50178)	
Rated voltage	250 V
Impulse withstand voltage	5 kV (1.2/50 µs)
Dielectric strength input - output	5 kV <sub>eff</sub> / 1min
Dielectric strength, contact / contact	
Dielectric strength to mounting rail	
Creepage and clearance distance input - output	≥ 8 mm
Overvoltage category	III
Pollution degree	2
Dimensions	
Depth x width x height	mm 25.5 / 13 / 29
Plug-in connection	
Depth x width x height	mm 25.5 / 13 / 29
Note	

**Applications**

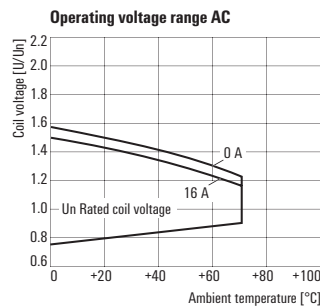
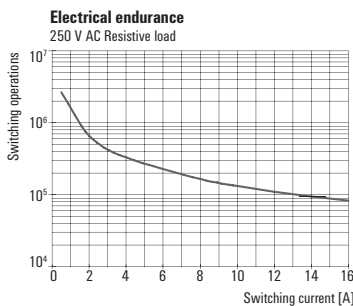
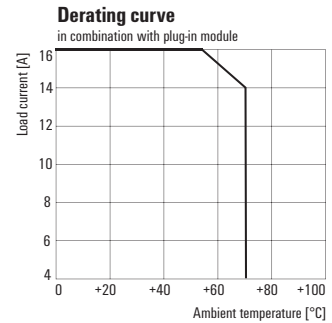
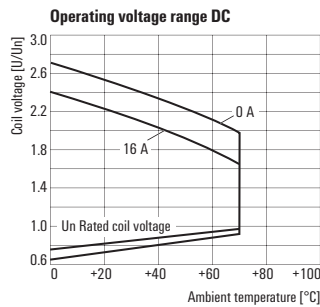
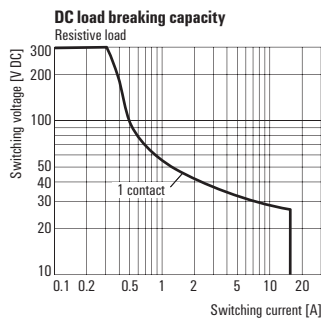

**Removal of snap lock**

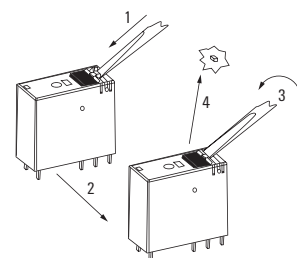

**RCI relay**  
**1 CO contact AC/DC coil**

Type code	RCI				
Type	RIDER Control Industrial				
Type of construction	3 1-pole, 16 A 4 2-pole, 8 A				
Type of contact	1 1 CO contact without test button 2 2 CO contacts without test button 7 1 CO contact with test button 8 2 CO contacts with test button				
Contact material	4 AgNi 90/10				
Coil	012 12 V DC 024 24 V DC 048 48 V DC 110 110 V DC 524 24 V AC 615 115 V AC 730 230 V AC AB2 12 V DC+LED+diode AC4 24 V DC+LED+diode AE8 48 V DC+LED+diode BB0 110 V DC+LED+diode R24 24 V AC+LED S15 115 V AC+LED T30 230 V AC+LED				

**Ordering data**

		12 V DC 1CO	24 V DC 1CO	48 V DC 1CO	110 V DC 1CO
<b>Input</b>					
Rated control voltage		12 V DC	24 V DC	48 V DC	110 V DC
Rated current AC / DC		/ 33.3 mA	/ 16.7 mA	/ 8.7 mA	/ 4.1 mA
Power rating		400 mW	400 mW	400 mW	400 mW
Pull-in/drop-out voltage, typ.		8.4 V / 1.2 V DC	16.8 V / 2.4 V DC	33.6 V / 4.8 V DC	77 V / 11 V DC
<b>Output</b>					
Switch-on delay		≤ 8 ms	≤ 8 ms	≤ 8 ms	≤ 8 ms
Switch-off delay		≤ 6 ms	≤ 6 ms	≤ 6 ms	≤ 6 ms
<b>Ordering data</b>					
Standard	Type	RCI314012	RCI314024	RCI314048	RCI314110
	Order No.	<b>8869800000</b>	<b>8869810000</b>	<b>8869820000</b>	<b>8869830000</b>
w. test button	Type	RCI374012	RCI374024		
	Order No.	<b>8869950000</b>	<b>8869960000</b>		
With LED + freewheel diode	Type	RCI314AB2	RCI314AC4	RCI314AE8	RCI314BB0
	Order No.	<b>8870090000</b>	<b>8870100000</b>	<b>8870110000</b>	<b>8870120000</b>
With test button + LED + Free-wheel diode	Type	RCI374AB2	RCI374AC4	RCI374AE8	RCI374BB0
	Order No.	<b>8870240000</b>	<b>8870250000</b>	<b>8870260000</b>	<b>8870270000</b>
<b>Note</b>					

**Ordering data**

		24 V AC 1CO	115 V AC 1CO	230 V AC 1CO
<b>Input</b>				
Rated control voltage		24 V AC	115 V AC	230 V AC
Rated current AC / DC		31.6 mA /	6.6 mA /	3.2 mA /
Power rating		0.75 VA	0.75 VA	0.75 VA
Pull-in/drop-out voltage, typ.		18 V / 3.6 V AC	86.3 V / 17.3 V AC	172.5 V / 34.5 V AC
<b>Output</b>				
Switch-on delay		≤ 8 ms	≤ 8 ms	≤ 8 ms
Switch-off delay		≤ 6 ms	≤ 6 ms	≤ 6 ms
<b>Ordering data</b>				
Standard	Type	RCI314524	RCI314615	RCI314730
	Order No.	<b>8869840000</b>	<b>8869850000</b>	<b>8869860000</b>
w. test button	Type	RCI374524		RCI374730
	Order No.	<b>8869990000</b>		<b>8870010000</b>
with LED	Type	RCI314R24	RCI314S15	RCI314T30
	Order No.	<b>8870130000</b>	<b>8870140000</b>	<b>8870150000</b>
With test button + LED	Type	RCI374R24	RCI374S15	RCI374T30
	Order No.	<b>8870280000</b>	<b>8870290000</b>	<b>8870300000</b>
<b>Note</b>				



**RIDERSERIES relay modules**

**RCI relay**

**2 CO contact AC / DC coil**

- 2000 VA switching capacity
- Stable plug-in connections
- Optional test button with latching function and inspection window
- Optional status indicator (AC red / DC green)
- Optional protective suppressor circuit
- Identification of coils (AC red / DC blue)



**B**

**Circuit diagram**

View on solder pins  
dimensions in mm

2 C/O changeover contacts

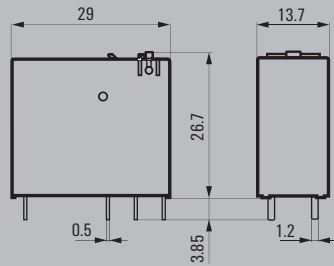
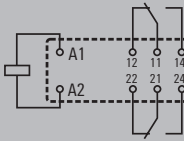

**Technical data**

Output	
Rated switching voltage / Continuous current	240 V AC / 8 A
Max. switching voltage, AC	400 V
Inrush current	15 A / 4 s
Min. switching power	100 mA / 5 V, 10 V / 10 mA, 24 V / 1 mA
DC / AC Switching capacity (resistive), max.	192 W @ 24 V / 2000 VA
Contact material	AgNi 90/10
Mechanical service life	AC coil 5 x 10 <sup>6</sup> Switch. cycles, DC coil 10 x 10 <sup>6</sup> Switch. cycles
Max. switching frequency at rated load	0.1 Hz
Rated data	
Ambient temperature (operational)	-40 °C...70 °C
Storage temperature	-40 °C...85 °C
Humidity	40 °C / 93 % rel. humidity, no condensation
Approvals	CSA; cURus; EAC; VDE
Insulation coordination (EN 50178)	
Rated voltage	250 V
Impulse withstand voltage	5 kV (1.2/50 µs)
Dielectric strength input - output	5 kV <sub>eff</sub> / 1min
Dielectric strength, contact / contact	
Dielectric strength to mounting rail	
Creepage and clearance distance input - output	≥ 8 mm
Overvoltage category	III
Pollution degree	2
Dimensions	
Depth x width x height	mm 25.5 / 13 / 29
Plug-in connection	
Depth x width x height	mm 25.5 / 13 / 29
Note	
	x = 25.5 without test button / 26.7 with test button

**Applications**

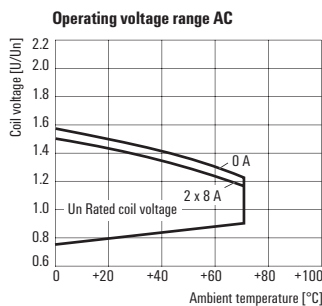
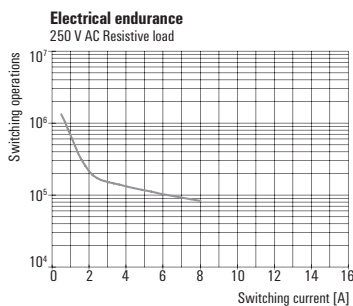
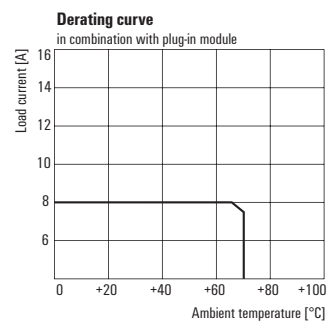
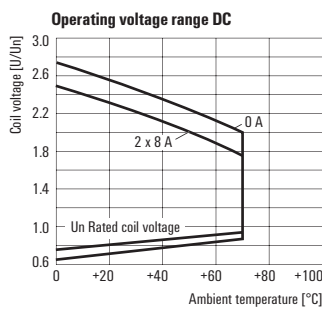
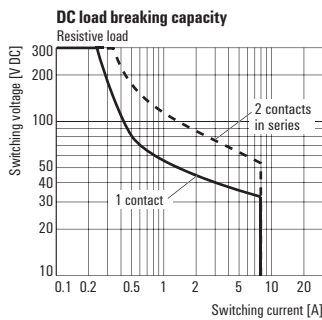

**Removal of snap lock**

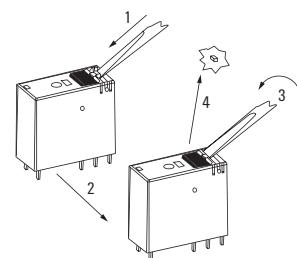

**RCI relay**  
**2 CO contact AC / DC coil**

Type code	RCI				
Type	RIDER Control Industrial				
Type of construction	3 1-pole, 16 A 4 2-pole, 8 A				
Type of contact	1 1 CO contact without test button 2 2 CO contacts without test button 7 1 CO contact with test button 8 2 CO contacts with test button				
Contact material	4 AgNi 90/10				
Coil	012 12 V DC 024 24 V DC 048 48 V DC 110 110 V DC 524 24 V AC 615 115 V AC 730 230 V AC AB2 12 V DC+LED+diode AC4 24 V DC+LED+diode AE8 48 V DC+LED+diode BB0 110 V DC+LED+diode R24 24 V AC+LED S15 115 V AC+LED T30 230 V AC+LED				

**Ordering data**

		12 V DC 2CO	24 V DC 2CO	48 V DC 2CO	110 V DC 2CO
<b>Input</b>					
Rated control voltage		12 V DC	24 V DC	48 V DC	110 V DC
Rated current AC / DC		/ 33.3 mA	/ 16.7 mA	/ 8.7 mA	/ 4.1 mA
Power rating		400 mW	400 mW	400 mW	400 mW
Pull-in/drop-out voltage, typ.		8.4 V / 1.2 V DC	16.8 V / 2.4 V DC	33.6 V / 4.8 V DC	77 V / 11 V DC
<b>Output</b>					
Switch-on delay		≤ 10 ms	≤ 10 ms	≤ 10 ms	≤ 10 ms
Switch-off delay		≤ 6 ms	≤ 6 ms	≤ 6 ms	≤ 6 ms
<b>Ordering data</b>					
Standard	Type	RCI424012	RCI424024	RCI424048	RCI424110
	Order No.	<b>8869870000</b>	<b>8869890000</b>	<b>8869900000</b>	<b>8869910000</b>
w. test button	Type	RCI484012	RCI484024	RCI484048	RCI484110
	Order No.	<b>8870020000</b>	<b>8870030000</b>	<b>8870040000</b>	<b>8870050000</b>
With LED + freewheel diode	Type	RCI424AB2	RCI424AC4	RCI424AE8	RCI424BB0
	Order No.	<b>8870170000</b>	<b>8870180000</b>	<b>8870190000</b>	<b>8870200000</b>
With test button + LED + Free-wheel diode	Type	RCI484AB2	RCI484AC4	RCI484AE8	RCI484BB0
	Order No.	<b>8870310000</b>	<b>8870320000</b>	<b>8870330000</b>	<b>8870340000</b>
<b>Note</b>					

**Ordering data**

		24 V AC 2CO	115 V AC 2CO	230 V AC 2CO
<b>Input</b>				
Rated control voltage		24 V AC	115 V AC	230 V AC
Rated current AC / DC		31.6 mA /	6.6 mA /	3.2 mA /
Power rating		0.75 VA	0.75 VA	0.75 VA
Pull-in/drop-out voltage, typ.		18 V / 3.6 V AC	86.3 V / 17.3 V AC	172.5 V / 34.5 V AC
<b>Output</b>				
Switch-on delay		≤ 10 ms	≤ 10 ms	≤ 10 ms
Switch-off delay		≤ 6 ms	≤ 6 ms	≤ 6 ms
<b>Ordering data</b>				
Standard	Type	RCI424524	RCI424615	RCI424730
	Order No.	<b>8869920000</b>	<b>8869930000</b>	<b>8869940000</b>
w. test button	Type	RCI484524	RCI484615	RCI484730
	Order No.	<b>8870060000</b>	<b>8870070000</b>	<b>8870080000</b>
with LED	Type	RCI424R24	RCI424S15	RCI424T30
	Order No.	<b>8870210000</b>	<b>8870220000</b>	<b>8870230000</b>
With test button + LED	Type	RCI484R24	RCI484S15	RCI484T30
	Order No.	<b>8870350000</b>	<b>8870360000</b>	<b>8870370000</b>
<b>Note</b>				

**RIDERSERIES relay modules**

**RCM KIT**

**2 CO contacts, AC/ DC coil**

Modular system comprising of:

- Relay socket for rail mounting
- LED display unit (AC red / DC green)
- Retaining clip
- Pluggable relays with coil identification (AC red / DC blue)
- Markers

Independent of connection system:

- Screw or PUSH IN connection system

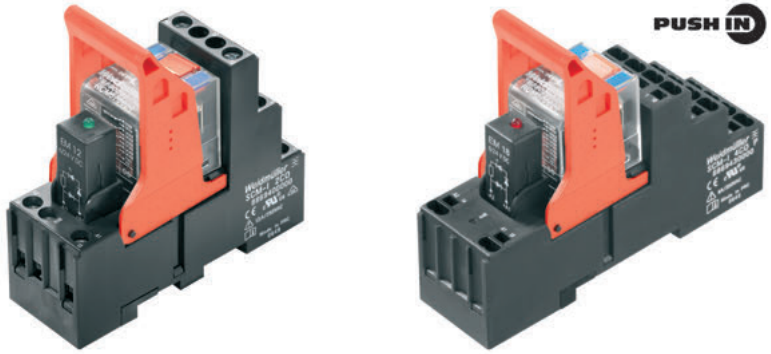

**B**

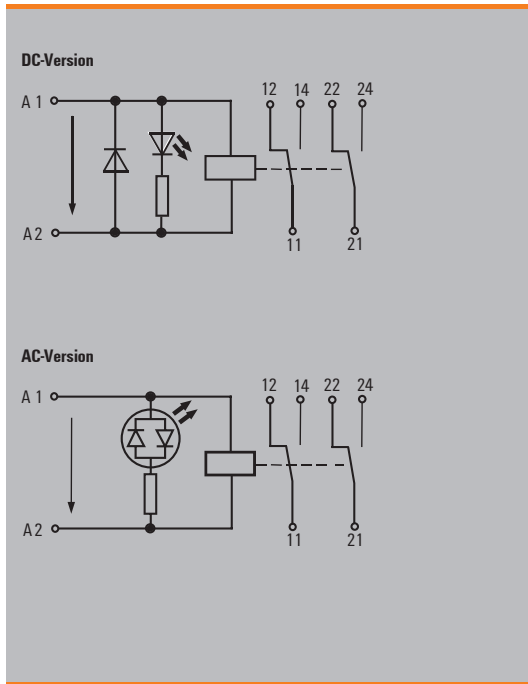

**Technical data**

<b>Output</b>		
Rated switching voltage / Continuous current	250 V AC / 12 A	
Max. switching voltage, AC	400 V	
Inrush current	24 A / 20 ms	
Min. switching power	100 mA / 5 V, 10 V / 10 mA, 24 V / 1 mA	
DC / AC Switching capacity (resistive), max.	288 W @ 24 V / 3000 VA	
Contact material	AgNi 90/10	
Mechanical service life	AC coil 20 x 10 <sup>6</sup> Switch. cycles, DC coil 30 x 10 <sup>6</sup> Switch. cycles	
Max. switching frequency at rated load	0.1 Hz	
<b>Rated data</b>		
Ambient temperature (operational)	-40 °C...70 °C	
Storage temperature	-40 °C...70 °C	
Humidity	40 °C / 93 % rel. humidity, no condensation	
Approvals	CE, EAC, GL	
<b>Insulation coordination (EN 50178)</b>		
Rated voltage	250 V	
Impulse withstand voltage	5 kV (1.2/50 µs)	
Dielectric strength input - output	2.5 KV <sub>eff</sub> / 1 min.	
Dielectric strength, contact / contact		
Dielectric strength to mounting rail		
Creepage and clearance distance input - output	≥ 4 mm	
Overvoltage category	III	
Pollution degree	2	
<b>Dimensions</b>		
	<b>Screw connection</b>	<b>PUSH IN spring connection</b>
Clamping range (nominal / min. / max.)	mm <sup>2</sup> 2.5 / 0.5 / 2.5	1.5 / 0.75 / 1.5
Depth x width x height	mm 79 / 28 / 77	79 / 28 / 98
<b>Note</b>		

**Ordering data**

		<b>24 V DC 2CO LED</b>	<b>24 V AC 2CO LED</b>	<b>115 V AC 2CO LED</b>	<b>230 V AC 2CO LED</b>
<b>Input</b>					
Rated control voltage		24 V DC	24 V AC	115 V AC	230 V AC
Rated current AC / DC		/ 31.3 mA	41.6 mA /	8.8 mA /	4.3 mA /
Power rating		740 mW	1.0 VA	1.0 VA	1.0 VA
Pull-in/drop-out voltage, typ.		18 V / 2.4 V DC	19.2 V / 7.2 V AC	92 V / 34.5 V AC	184 V / 69 V AC
Status indicator		Green LED, Mechanical	red LED, Mechanical	red LED, Mechanical	red LED, Mechanical
Protective circuit		Integrated free-wheel diode			
<b>Output</b>					
Switch-on delay		≤ 15 ms	≤ 15 ms	≤ 15 ms	≤ 15 ms
Switch-off delay		≤ 10 ms	≤ 10 ms	≤ 10 ms	≤ 10 ms
<b>Ordering data</b>					
Screw connection	Type	RCMKIT-I 24VDC 2CO LD	RCMKIT-I 24VAC 2CO LD	RCMKIT-I 115VAC 2CO LD	RCMKIT-I 230VAC 2CO LD
	Order No.	<b>8920940000</b>	<b>8920950000</b>	<b>8920960000</b>	<b>8920970000</b>
PUSH IN connection	Type	RCMKITP-I 24VDC 2CO LD	RCMKITP-I 24VAC 2CO LD	RCMKITP-I 115VAC 2CO LD	RCMKITP-I 230VAC 2CO LD
	Order No.	<b>8921080000</b>	<b>8921090000</b>	<b>8921100000</b>	<b>8921110000</b>
<b>Ordering data</b>					
Spare relay (pluggable)	Type	RCM270024	RCM270524	RCM270615	RCM270730
	Order No.	<b>8689860000</b>	<b>8689760000</b>	<b>8689800000</b>	<b>8689820000</b>
<b>Note</b>					

Accessories for  
RCM KIT relay modules, 2 CO

Plug-in module with PUSH IN connection

Plug-in module with screw connection

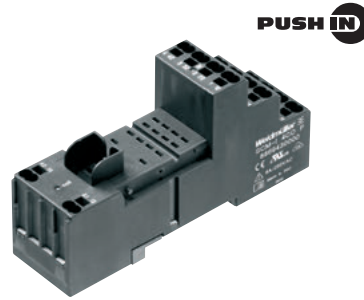

Technical data

Rated current	12 A
Rated voltage	240 V AC
Dielectric strength of coil contacts	> 2500 V <sub>eff</sub>
Ambient temperature (operational)	-45 °C ...+70 °C
Insulation group (VDE 0110b)	C / 250 V AC
Protection class (IEC 61810)	IP 20
Stripping length	12 mm
Approvals	VDE, cURus, CSA
Connection cross-section	
- Solid-core wire	1 x 0.75/1/1.5 mm <sup>2</sup> / 2 x 0.75/1 mm <sup>2</sup>
- Stranded wire	1 x 0.75/1/1.5 mm <sup>2</sup> / 2 x 0.75/1 mm <sup>2</sup>
- with ferrule	1 x 0.75/1 mm <sup>2</sup> / 2 x 0.75 mm <sup>2</sup>
Rated torque acc. to IEC 61984 for screw connection	
Plug-in cycles	A (10)

Rated current	12 A
Rated voltage	240 V AC
Dielectric strength of coil contacts	> 2500 V <sub>eff</sub>
Ambient temperature (operational)	-45 °C ...+70 °C
Insulation group (VDE 0110b)	C / 250 V AC
Protection class (IEC 61810)	IP 20
Stripping length	8 mm
Approvals	VDE, cURus, CSA
Connection cross-section	
- Solid-core wire	2 x 2.5 mm <sup>2</sup>
- Stranded wire	2 x 2.5 mm <sup>2</sup>
- with ferrule	2 x 1.5 mm <sup>2</sup>
Rated torque acc. to IEC 61984 for screw connection	0.5 Nm / max. 0.7 Nm
Plug-in cycles	A (10)

Rated current	12 A
Rated voltage	240 V AC
Dielectric strength of coil contacts	> 2500 V <sub>eff</sub>
Ambient temperature (operational)	-45 °C ...+70 °C
Insulation group (VDE 0110b)	C / 250 V AC
Protection class (IEC 61810)	IP 20
Stripping length	8 mm
Approvals	VDE, cURus, CSA
Connection cross-section	
- Solid-core wire	2 x 2.5 mm <sup>2</sup>
- Stranded wire	2 x 2.5 mm <sup>2</sup>
- with ferrule	2 x 1.5 mm <sup>2</sup>
Rated torque acc. to IEC 61984 for screw connection	0.5 Nm / max. 0.7 Nm
Plug-in cycles	A (10)



Ordering data

Description
Plug-in module, snaps onto TS35 DIN mounting rail, 2-pole

Type	Qty.	Order No.
SCM-H 2CO P		8876220000

Type	Qty.	Order No.
SCM-H 2CO		8869400000

Accessories

Description
Plastic retaining clip
Metal retaining clip
Marker
Marker, Multicard
 Cross-connector for PUSH IN base, 2-pole, 12 A
 Cross-connector for screw base, 6-pole

Type	Qty.	Order No.
SCM-H CLIP P	10	8869440000
SCM-H CLIP M	10	8869450000
SCM-H MARK	10	8869460000
ESG 9/11 K MC neutral	200	1857440000
SCM-H QV P	10	8870850000

Type	Qty.	Order No.
SCM-H CLIP P	10	8869440000
SCM-H CLIP M	10	8869450000
SCM-H MARK	10	8869460000
ESG 9/11 K MC neutral	200	1857440000
SCM-H QV S	10	1132080000

Dimensions

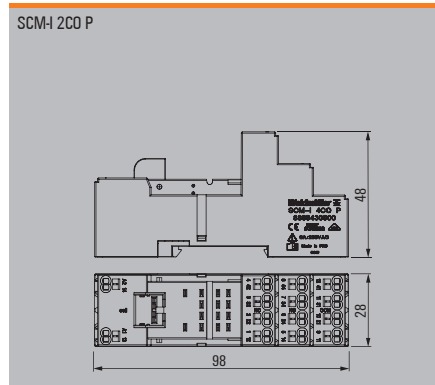

Dimensions

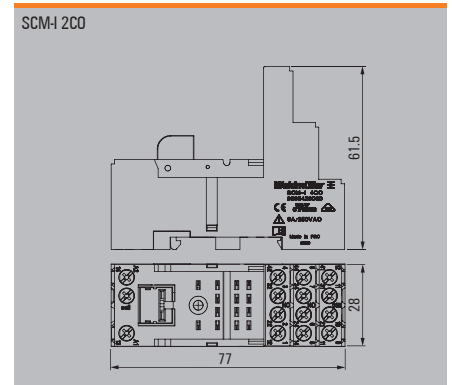

Dimensions in mm

**RIDERSERIES – RCM KIT 2 CO accessories**

**LED and protective modules for the SCM-I plug-in frame**

Plug simply into the base module; reverse-connect protection. Connect parallel to coil.

**Ordering data**

Description
Free Wheel diode 1N4007
Resistor 100 kΩ 1 Watt
RC element 6 ... 60 V AC; 470 Ω / 220 nF
RC element 110 ... 230 V AC; 4.7 Ω / 10 nF
Varistor protection 24 V; S07K30
Varistor protection 110 V; S07K130
Varistor protection 230 V; S07K275
LED
LED 6 ... 24 V DC with free wheel diode
LED 24 ... 60 V DC with free wheel diode
LED 110 ... 230 V DC with free wheel diode
LED 6 ... 24 V DC / V AC
LED 24 ... 60 V DC / V AC
LED 110 ... 230 V DC / V AC

Type	Qty.	Order No.	Order No.
RIM-I 1 6/230V	10	<b>8869580000</b>	
RIM-I 1 R 110/230V	10	<b>8870830000</b>	
RIM-I 3 6/60VAC	10	<b>8869770000</b>	
RIM-I 3 110/230VAC	10	<b>8869790000</b>	
RIM-I 4 24VUC	10	<b>8869710000</b>	
RIM-I 4 110VUC	10	<b>8869730000</b>	
RIM-I 4 230VUC	10	<b>8869750000</b>	
		<b>red</b>	<b>green</b>
RIM-I 2 6/24VDC	10	<b>8869590000</b>	<b>8869600000</b>
RIM-I 2 24/60VDC	10	<b>8869670000</b>	<b>8869680000</b>
RIM-I 2 110/230VDC	10	<b>8869690000</b>	<b>8869700000</b>
RIM-I 3 6/24VUC	10	<b>8869630000</b>	<b>8869640000</b>
RIM-I 3 24/60VUC	10	<b>8869610000</b>	<b>8869620000</b>
RIM-I 3 110/230VUC	10	<b>8869650000</b>	<b>8869660000</b>

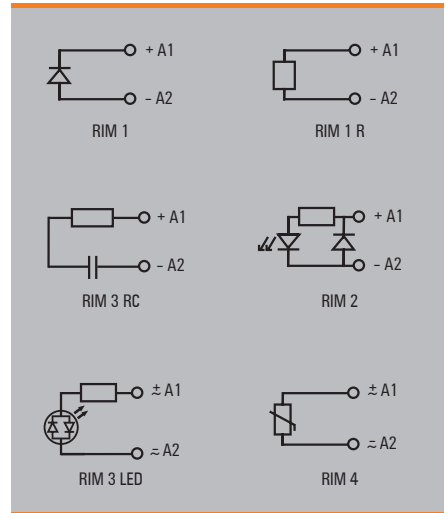

**Warnings and notes on usage**

**Handling the PUSH IN connection**

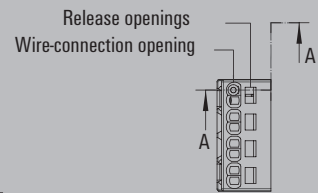
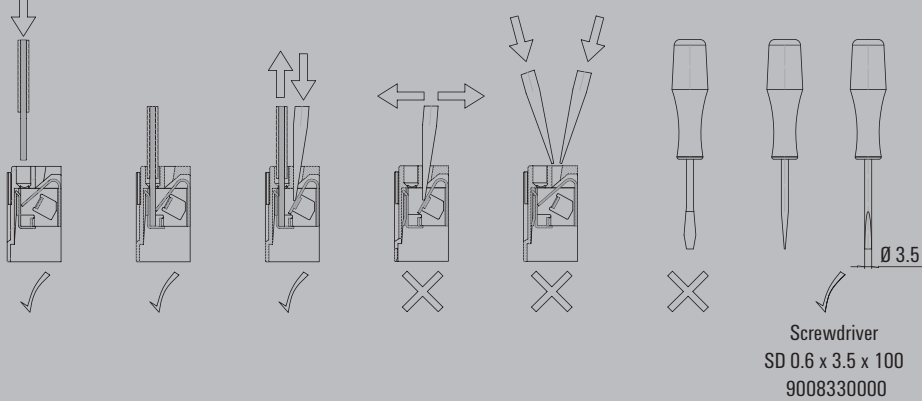

**Cross-connector mounting for PUSH IN base**

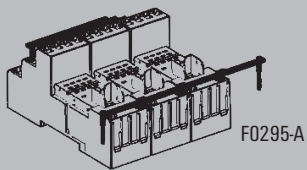

If more than two poles need to be connected with stacked cross-connector ridges, then the lower ridge must be stripped and shortened to the proper length so it will fit.

**Cross-connector mounting for screw base**

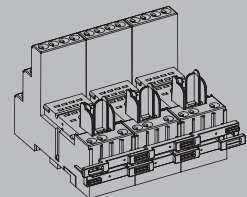

### RCM KIT

#### 3 CO contacts, AC/ DC coil

Modular system comprising of:

- Relay socket for rail mounting
- LED display unit (AC red / DC green)
- Retaining clip
- Pluggable relay modules
- Identification of coils (AC red / DC blue)
- Markers

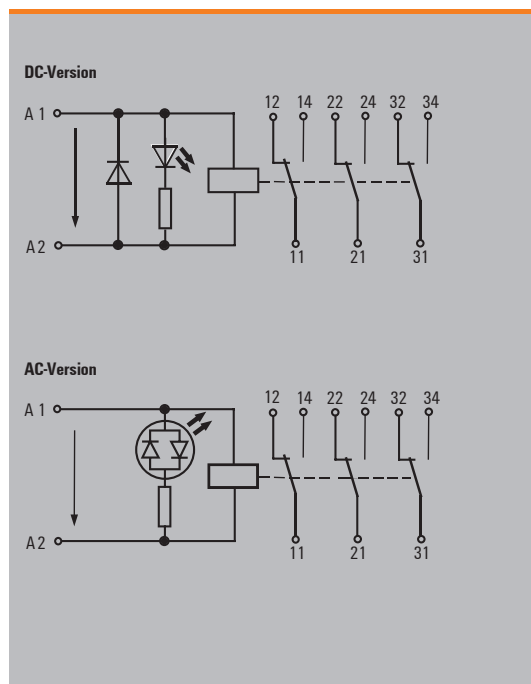
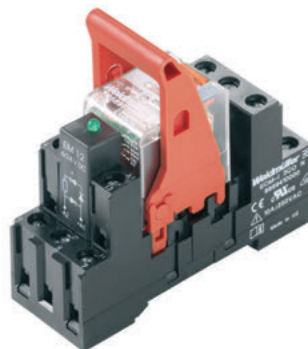

#### Technical data

Output	
Rated switching voltage / Continuous current	250 V AC / 10 A
Max. switching voltage, AC	400 V
Inrush current	20 A / 20 ms
Min. switching power	100 mA / 5 V, 10 V / 10 mA, 24 V / 1 mA
DC / AC Switching capacity (resistive), max.	240 W @ 24 V / 2500 VA
Contact material	AgNi 90/10
Mechanical service life	AC coil 20 x 10 <sup>6</sup> Switch. cycles, DC coil 30 x 10 <sup>6</sup> Switch. cycles
Max. switching frequency at rated load	0.1 Hz
Rated data	
Ambient temperature (operational)	-40 °C...70 °C
Storage temperature	-40 °C...70 °C
Humidity	40 °C / 93 % rel. humidity, no condensation
Approvals	CE, EAC, GL
Insulation coordination (EN 50178)	
Rated voltage	250 V
Impulse withstand voltage	5 kV (1.2/50 µs)
Dielectric strength input - output	2.5 KV <sub>eff</sub> / 1 min.
Dielectric strength, contact / contact	
Dielectric strength to mounting rail	
Creepage and clearance distance input - output	≥ 4 mm
Overvoltage category	III
Pollution degree	2
Dimensions	
Clamping range (nominal / min. / max.)	mm <sup>2</sup> 2.5 / 0.5 / 2.5
Depth x width x height	mm 72 / 28 / 74
Screw connection	
<b>Note</b>	

#### Ordering data

	24 V DC 3CO LED	24 V AC 3CO LED	115 V AC 3CO LED	230 V AC 3CO LED
<b>Input</b>				
Rated control voltage	24 V DC	24 V AC	115 V AC	230 V AC
Rated current AC / DC	/ 31.3 mA	41.6 mA /	8.8 mA /	4.3 mA /
Power rating	740 mW	1.0 VA	1.0 VA	1.0 VA
Pull-in/drop-out voltage, typ.	18 V / 2.4 V DC	19.2 V / 7.2 V AC	92 V / 34.5 V AC	184 V / 69 V AC
Status indicator	Green LED, Mechanical	red LED, Mechanical	red LED, Mechanical	red LED, Mechanical
Protective circuit	Integrated free-wheel diode			
<b>Output</b>				
Switch-on delay	≤ 15 ms	≤ 15 ms	≤ 15 ms	≤ 15 ms
Switch-off delay	≤ 10 ms	≤ 10 ms	≤ 10 ms	≤ 10 ms
<b>Ordering data</b>				
Screw connection	Type RCMKIT-I 24VDC 3CO LD	Type RCMKIT-I 24VAC 3CO LD	Type RCMKIT-I 115VAC 3CO LD	Type RCMKIT-I 230VAC 3CO LD
Order No.	8920980000	8920990000	8921010000	8921020000
Spare relay (pluggable)	Type RCM370024	Type RCM370524	Type RCM370615	Type RCM370730
Order No.	8690040000	8690030000	8689980000	8690000000
<b>Note</b>				

**Accessories for  
RCM KIT relay modules, 3 CO**

**Plug-in module with screw connection**

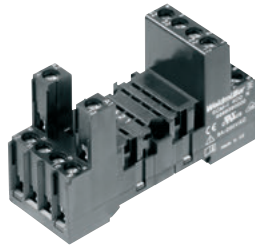

**Technical data**

Rated current	10 A
Rated voltage	240 V AC
Dielectric strength of coil contacts	> 2500 V <sub>eff</sub>
Ambient temperature (operational)	-45 °C ...+70 °C
Insulation group (VDE 0110b)	C / 250 V AC
Protection class (IEC 61810)	IP 20
Approvals	VDE, cURus, CSA
Connection cross-section	
- Solid-core wire	2 x 2.5 mm <sup>2</sup>
- Stranded wire	2 x 2.5 mm <sup>2</sup>
- with ferrule	2 x 1.5 mm <sup>2</sup>
Rated torque acc. to IEC 61984 for screw connection	0.5 Nm / max. 0.7 Nm
Plug-in cycles	A (10)

**Ordering data**

Description
Plug-in module, snaps onto TS35 DIN mounting rail, 3-pole

Type	Qty.	Order No.
SCM-H 3CO N		8869410000

**Accessories**

Description
Plastic retaining clip
Metal retaining clip
Marker
Marker, Multicard
 Cross-connector for screw base, 6-pole

Type	Qty.	Order No.
SCM-H CLIP N	10	8875620000
SCM-H CLIP M	10	8869450000
SCM-H MARK	10	8869460000
ESG 9/11 K MC neutral	200	1857440000
SCM-H QV S	10	1132080000

**Dimensions**

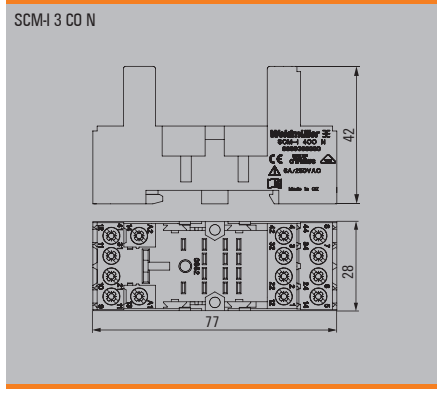

Dimensions in mm

**LED and protective modules for the SCM-I plug-in frame**

Simply plug into the base module; reverse-connect protection. Connect parallel to coil.

**Ordering data**

Description
Free Wheel diode 1N4007
Resistor 100 k $\Omega$ 1 Watt
RC element 6 ... 60 V AC; 470 $\Omega$ / 220 nF
RC element 110 ... 230 V AC; 4.7 $\Omega$ / 10 nF
Varistor protection 24 V; S07K30
Varistor protection 110 V; S07K130
Varistor protection 230 V; S07K275
LED
LED 6 ... 24 V DC with free wheel diode
LED 24 ... 60 V DC with free wheel diode
LED 110 ... 230 V DC with free wheel diode
LED 6 ... 24 V DC / V AC
LED 24 ... 60 V DC / V AC
LED 110 ... 230 V DC / V AC

Type	Qty.	Order No.	Order No.
RIM-I 1 6/230V	10	<b>8869580000</b>	
RIM-I 1 R 110/230V	10	<b>8870830000</b>	
RIM-I 3 6/60VAC	10	<b>8869770000</b>	
RIM-I 3 110/230VAC	10	<b>8869790000</b>	
RIM-I 4 24VUC	10	<b>8869710000</b>	
RIM-I 4 110VUC	10	<b>8869730000</b>	
RIM-I 4 230VUC	10	<b>8869750000</b>	
		<b>red</b>	<b>green</b>
RIM-I 2 6/24VDC	10	<b>8869590000</b>	<b>8869600000</b>
RIM-I 2 24/60VDC	10	<b>8869670000</b>	<b>8869680000</b>
RIM-I 2 110/230VDC	10	<b>8869690000</b>	<b>8869700000</b>
RIM-I 3 6/24VUC	10	<b>8869630000</b>	<b>8869640000</b>
RIM-I 3 24/60VUC	10	<b>8869610000</b>	<b>8869620000</b>
RIM-I 3 110/230VUC	10	<b>8869650000</b>	<b>8869660000</b>

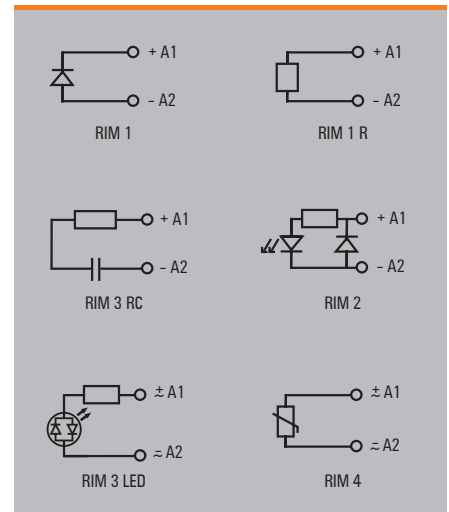
**Warnings and notes on usage**

Cross-connector mounting for screw base

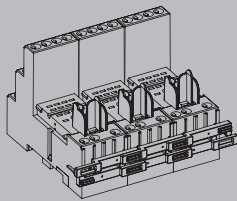



**RIDERSERIES relay modules**

**RCM KIT**

**4 CO contacts, AC/ DC coil**

Modular system comprising of:

- relay socket for rail mounting
- LED display unit (AC red / DC green)
- retaining clip
- pluggable relays with coil identification (AC red / DC blue)
- Markers

Independent of connection system:

- Screw or PUSH IN connection system

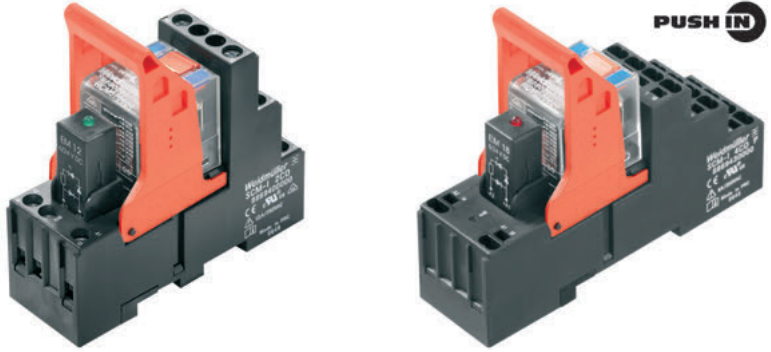

**B**

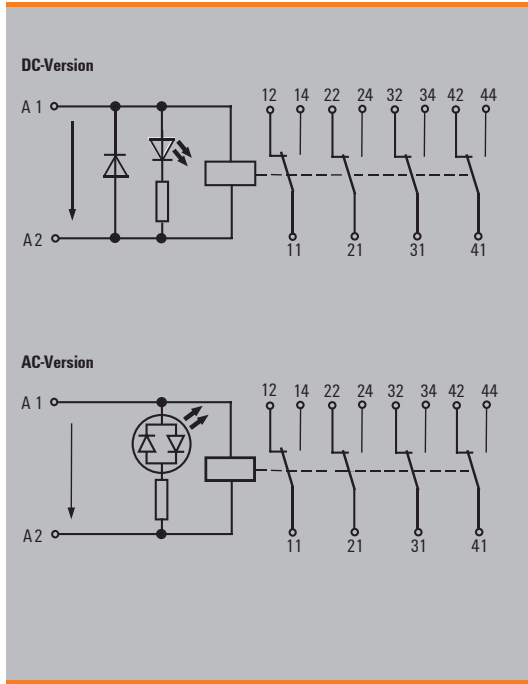

**Technical data**

Output		
Rated switching voltage / Continuous current	250 V AC / 6 A	
Max. switching voltage, AC	240 V	
Inrush current	12 A / 20 ms	
Min. switching power	100 mA / 5 V, 10 V / 10 mA, 24 V / 1 mA	
DC / AC Switching capacity (resistive), max.	144 W @ 24 V / 1500 VA	
Contact material	AgNi 90/10	
Mechanical service life	AC coil 20 x 10 <sup>6</sup> Switch. cycles, DC coil 30 x 10 <sup>6</sup> Switch. cycles	
Max. switching frequency at rated load	0.1 Hz	
Rated data		
Ambient temperature (operational)	-40 °C...70 °C	
Storage temperature	-40 °C...70 °C	
Humidity	40 °C / 93 % rel. humidity, no condensation	
Approvals	CE, EAC, GL	
Insulation coordination (EN 50178)		
Rated voltage	250 V	
Impulse withstand voltage	5 kV (1.2/50 µs)	
Dielectric strength input - output	2.5 KV <sub>eff</sub> / 1 min.	
Dielectric strength, contact / contact		
Dielectric strength to mounting rail		
Creepage and clearance distance input - output	≥ 4 mm	
Overvoltage category	III	
Pollution degree	2	
Dimensions		
Clamping range (nominal / min. / max.)	Screw connection	2.5 / 0.5 / 2.5
	PUSH IN spring connection	1.5 / 0.75 / 1.5
Depth x width x height	Screw connection	79 / 28 / 77
	PUSH IN spring connection	79 / 28 / 98
Note		

**Ordering data**

		24 V DC 4CO LED	24 V AC 4CO LED	115 V AC 4CO LED	230 V AC 4CO LED
<b>Input</b>					
Rated control voltage		24 V DC	24 V AC	115 V AC	230 V AC
Rated current AC / DC		/ 31.3 mA	41.6 mA /	8.8 mA /	4.3 mA /
Power rating		740 mW	1.0 VA	1.0 VA	1.0 VA
Pull-in/drop-out voltage, typ.		18 V / 2.4 V DC	19.2 V / 7.2 V AC	92 V / 34.5 V AC	184 V / 69 V AC
Status indicator		Green LED, Mechanical	red LED, Mechanical	red LED, Mechanical	red LED, Mechanical
Protective circuit		Integrated free-wheel diode			
<b>Output</b>					
Switch-on delay		≤ 15 ms	≤ 15 ms	≤ 15 ms	≤ 15 ms
Switch-off delay		≤ 10 ms	≤ 10 ms	≤ 10 ms	≤ 10 ms
<b>Ordering data</b>					
Screw connection	Type	RCMKIT-I 24VDC 4CO LD	RCMKIT-I 24VAC 4CO LD	RCMKIT-I 115VAC 4CO LD	RCMKIT-I 230VAC 4CO LD
	Order No.	8921030000	8921040000	8921050000	8921060000
PUSH IN connection	Type	RCMKITP-I 24VDC 4CO LD	RCMKITP-I 24VAC 4CO LD	RCMKITP-I 115VAC 4CO LD	RCMKITP-I 230VAC 4CO LD
	Order No.	8921120000	8921130000	8921140000	8921150000
<b>Ordering data</b>					
Spare relay (pluggable)	Type	RCM570024	RCM570524	RCM570615	RCM570730
	Order No.	8690200000	8690110000	1180800000	1181100000
<b>Note</b>					

Accessories for RCM KIT relay modules, 4 CO

Plug-in module with PUSH IN connection

Plug-in module with screw connection

Plug-in module with screw connection

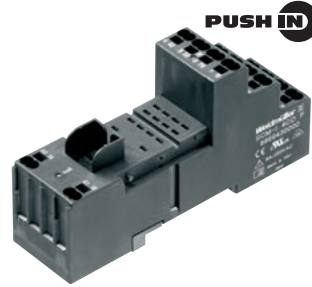

Standard height



Low height

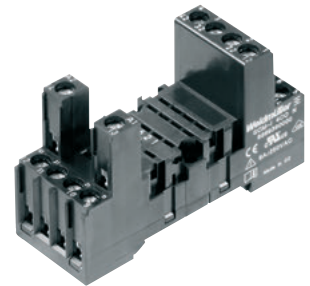

Technical data

Rated current	6 A
Rated voltage	240 V AC
Dielectric strength of coil contacts	> 2500 V <sub>eff</sub>
Ambient temperature (operational)	-45 °C ...+70 °C
Insulation group (VDE 0110b)	C / 250 V AC
Protection class (IEC 61810)	IP 20
Stripping length	12 mm
Approvals	VDE, cURus, CSA
Connection cross-section	
- Solid-core wire	1 x 0.75/1/1.5 mm <sup>2</sup> / 2 x 0.75/1 mm <sup>2</sup>
- Stranded wire	1 x 0.75/1/1.5 mm <sup>2</sup> / 2 x 0.75/1 mm <sup>2</sup>
- with ferrule	1 x 0.75/1 mm <sup>2</sup> / 2 x 0.75 mm <sup>2</sup>
Rated torque acc. to IEC 61984 for screw connection	
Plug-in cycles	A (10)

Rated current	6 A
Rated voltage	240 V AC
Dielectric strength of coil contacts	> 2500 V <sub>eff</sub>
Ambient temperature (operational)	-45 °C ...+70 °C
Insulation group (VDE 0110b)	C / 250 V AC
Protection class (IEC 61810)	IP 20
Stripping length	8 mm
Approvals	VDE, cURus, CSA
Connection cross-section	
- Solid-core wire	2 x 2.5 mm <sup>2</sup>
- Stranded wire	2 x 2.5 mm <sup>2</sup>
- with ferrule	2 x 1.5 mm <sup>2</sup>
Rated torque acc. to IEC 61984 for screw connection	0.5 Nm / max. 0.7 Nm
Plug-in cycles	A (10)

Rated current	6 A
Rated voltage	240 V AC
Dielectric strength of coil contacts	> 2500 V <sub>eff</sub>
Ambient temperature (operational)	-45 °C ...+70 °C
Insulation group (VDE 0110b)	C / 250 V AC
Protection class (IEC 61810)	IP 20
Stripping length	8 mm
Approvals	VDE, cURus, CSA
Connection cross-section	
- Solid-core wire	2 x 2.5 mm <sup>2</sup>
- Stranded wire	2 x 2.5 mm <sup>2</sup>
- with ferrule	2 x 1.5 mm <sup>2</sup>
Rated torque acc. to IEC 61984 for screw connection	0.5 Nm / max. 0.7 Nm
Plug-in cycles	A (10)

Rated current	6 A
Rated voltage	240 V AC
Dielectric strength of coil contacts	> 2500 V <sub>eff</sub>
Ambient temperature (operational)	-45 °C ...+70 °C
Insulation group (VDE 0110b)	C / 250 V AC
Protection class (IEC 61810)	IP 20
Stripping length	8 mm
Approvals	VDE, cURus, CSA
Connection cross-section	
- Solid-core wire	2 x 2.5 mm <sup>2</sup>
- Stranded wire	2 x 2.5 mm <sup>2</sup>
- with ferrule	2 x 1.5 mm <sup>2</sup>
Rated torque acc. to IEC 61984 for screw connection	0.5 Nm / max. 0.7 Nm
Plug-in cycles	A (10)

Ordering data

Description
Plug-in module, snaps onto TS35 DIN mounting rail, 4-pole

Type	Qty.	Order No.
SCM-I 4CO P		8869430000

Type	Qty.	Order No.
SCM-I 4CO		8869420000

Type	Qty.	Order No.
SCM-I 4CO N		8869390000

Accessories

Description
Plastic retaining clip
Plastic retaining clip
Metal retaining clip
Marker
Marker, Multicard

Type	Qty.	Order No.
SCM-I CLIP P	10	8869440000
SCM-I CLIP M	10	8869450000
SCM-I MARK	10	8869460000
ESG 9/11 K MC neutral	200	1857440000
SCM-I QV P		8870850000

Type	Qty.	Order No.
SCM-I CLIP P	10	8869440000
SCM-I CLIP M	10	8869450000
SCM-I MARK	10	8869460000
ESG 9/11 K MC neutral	200	1857440000
SCM-I QV S		1132080000

Type	Qty.	Order No.
SCM-I CLIP N	10	8875620000
SCM-I CLIP M	10	8869450000
SCM-I MARK	10	8869460000
ESG 9/11 K MC neutral	200	1857440000
SCM-I QV S		1132080000

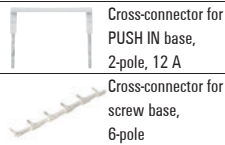

Dimensions

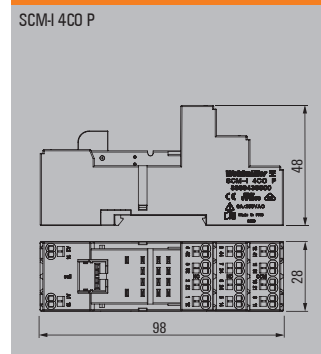

Dimensions

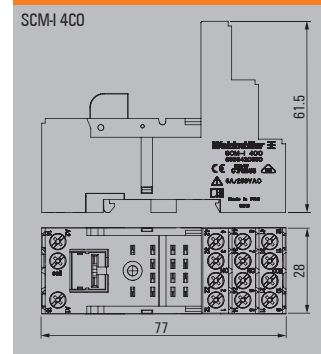

Dimensions

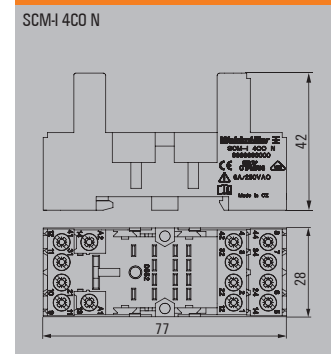

Dimensions in mm

**RIDERSERIES – RCM KIT 4 CO accessories**

**LED and protective modules for the SCM-I plug-in frame**

Simply plug into the base module; reverse-connect protection. Connect parallel to coil.

**Ordering data**

Description
Free Wheel diode 1N4007
Resistor 100 kΩ 1 Watt
RC element 6 ... 60 V AC; 470 Ω / 220 nF
RC element 110 ... 230 V AC; 4.7 Ω / 10 nF
Varistor protection 24 V; S07K30
Varistor protection 110 V; S07K130
Varistor protection 230 V; S07K275
LED
LED 6 ... 24 V DC with free wheel diode
LED 24 ... 60 V DC with free wheel diode
LED 110 ... 230 V DC with free wheel diode
LED 6 ... 24 V DC / V AC
LED 24 ... 60 V DC / V AC
LED 110 ... 230 V DC / V AC

Type	Qty.	Order No.	Order No.
RIM-I 1 6/230V	10	<b>8869580000</b>	
RIM-I 1 R 110/230V	10	<b>8870830000</b>	
RIM-I 3 6/60VAC	10	<b>8869770000</b>	
RIM-I 3 110/230VAC	10	<b>8869790000</b>	
RIM-I 4 24VUC	10	<b>8869710000</b>	
RIM-I 4 110VUC	10	<b>8869730000</b>	
RIM-I 4 230VUC	10	<b>8869750000</b>	
		red	green
RIM-I 2 6/24VDC	10	<b>8869590000</b>	<b>8869600000</b>
RIM-I 2 24/60VDC	10	<b>8869670000</b>	<b>8869680000</b>
RIM-I 2 110/230VDC	10	<b>8869690000</b>	<b>8869700000</b>
RIM-I 3 6/24VUC	10	<b>8869630000</b>	<b>8869640000</b>
RIM-I 3 24/60VUC	10	<b>8869610000</b>	<b>8869620000</b>
RIM-I 3 110/230VUC	10	<b>8869650000</b>	<b>8869660000</b>

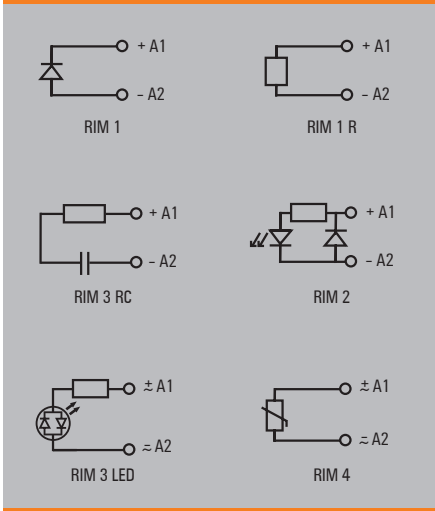

**Warnings and notes on usage**

**Handling the PUSH IN connection**

**Cross-connector mounting for PUSH IN base**

**Cross-connector mounting for screw base**

If more than two poles need to be connected with stacked cross-connector ridges, then the lower ridge must be stripped and shortened to the proper length so it will fit.

**Screwdriver**  
SD 0.6 x 3.5 x 100  
9008330000



**RCM relay**

**2 CO contacts, AC/DC coil**

- 3000 VA switching capacity
- Solder and plug connection
- Safe-to-touch test button, selectable locking
- White labelling panel
- Identification of coils (AC red / DC blue)



**B**

**Circuit diagram**  
Dimensions in mm

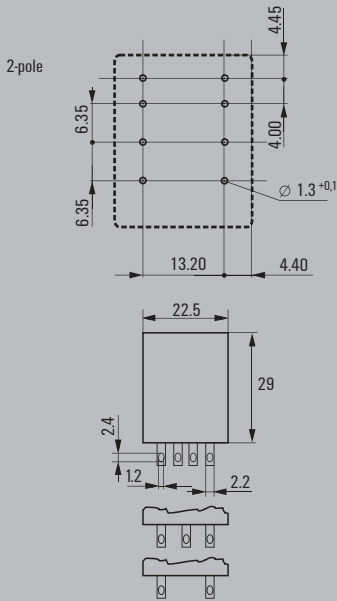

**Technical data**

Output	
Rated switching voltage / Continuous current	240 V AC / 12 A
Max. switching voltage, AC	400 V
Inrush current	24 A / 20 ms
Min. switching power	100 mA / 5 V, 10 V / 10 mA, 24 V / 1 mA
DC / AC Switching capacity (resistive), max.	288 W @ 24 V / 3000 VA
Contact material	AgNi 90/10
Mechanical service life	AC coil 20 x 10 <sup>6</sup> Switch. cycles, DC coil 30 x 10 <sup>6</sup> Switch. cycles
Max. switching frequency at rated load	0.1 Hz
Rated data	
Ambient temperature (operational)	-40 °C...70 °C
Storage temperature	-40 °C...85 °C
Humidity	40 °C / 93 % rel. humidity, no condensation
Approvals	CSA; cURus; EAC; VDE
Insulation coordination (EN 50178)	
Rated voltage	250 V
Impulse withstand voltage	5 kV (1.2/50 µs)
Dielectric strength input - output	2.5 KV <sub>eff</sub> / 1 min.
Dielectric strength, contact / contact	
Dielectric strength to mounting rail	
Creepage and clearance distance input - output	≥ 4 mm
Overvoltage category	III
Pollution degree	2
Dimensions	
Depth x width x height	mm 29 / 22.5 / 28
Plug-in connection	
Depth x width x height	mm 29 / 22.5 / 28
Note	

**Applications**

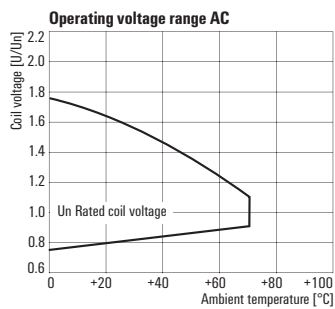
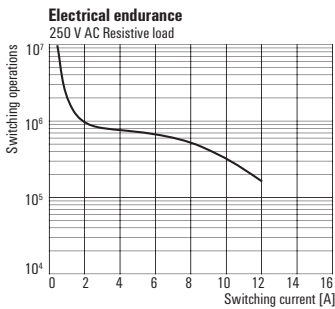
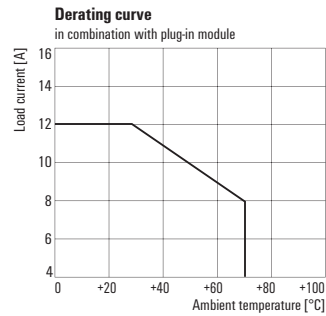
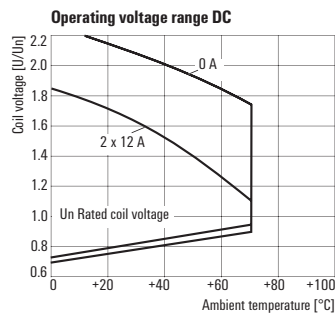
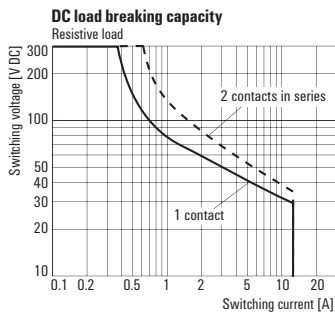

**RCM relay**  
**2 CO contacts, AC/DC coil**

Type code		RCM							
Type	RIDER Control Multiple								
Contacts	2 2 CO contacts 3 3 CO contacts 5 4 CO contacts								
Contact material	7 AgNi 90/10, with test button 8 AgNi 90/10 hgp, with test button								
Type of construction	0 Standard, 2.8 mm Faston								
DC coil									
006	6 V DC								with LED + diode
012	12 V DC								L06
024	24 V DC								L12 AB2
048	48 V DC								L24 AC4
060	60 V DC								L48 AE8
110	110 V DC								L60
220	220 V DC								M10 BBO
AC coil									
506	6 V AC								R06
512	12 V AC								R12
524	24 V AC								R24
548	48 V AC								R48
615	115 V AC								S15
730	230 V AC								T30

**Ordering data**

		12 V DC 2CO	24 V DC 2CO	48 V DC 2CO	110 V DC 2CO
<b>Input</b>					
Rated control voltage		12 V DC	24 V DC	48 V DC	110 V DC
Rated current AC / DC		/ 62.5 mA	/ 31.3 mA	/ 15.6 mA	/ 6.8 mA
Power rating		750 mW	750 mW	750 mW	750 mW
Pull-in/drop-out voltage, typ.		9 V / 1.2 V DC	18 V / 2.4 V DC	36 V / 4.8 V DC	82.5 V / 11.5 V DC
<b>Output</b>					
Switch-on delay		≤ 15 ms	≤ 15 ms	≤ 15 ms	≤ 15 ms
Switch-off delay		≤ 10 ms	≤ 10 ms	≤ 10 ms	≤ 10 ms
<b>Ordering data</b>					
Without LED	Type	RCM270012	RCM270024	RCM270048	RCM270110
AgNi 90/10	Order No.	<b>8689840000</b>	<b>8689860000</b>	<b>8689880000</b>	<b>8689900000</b>
with LED	Type	RCM270L12	RCM270L24	RCM270L48	
AgNi 90/10	Order No.	<b>8689850000</b>	<b>8689870000</b>	<b>8689890000</b>	
With LED + freewheel diode	Type	RCM270AB2	RCM270AC4		
AgNi 90/10	Order No.	<b>8957020000</b>	<b>8957030000</b>		
	Type				
	Order No.				

<b>Note</b>					
-------------	--	--	--	--	--

**Ordering data**

		24 V AC 2CO	48 V AC 2CO	115 V AC 2CO	230 V AC 2CO
<b>Input</b>					
Rated control voltage		24 V AC	48 V AC	115 V AC	230 V AC
Rated current AC / DC		41.6 mA /	21.3 mA /	8.8 mA /	4.3 mA /
Power rating		1.0 VA	1.0 VA	1.0 VA	1.0 VA
Pull-in/drop-out voltage, typ.		38.4 V / 14.4 V AC	48 V / 18 V AC	92 V / 34.5 V AC	184 V / 69 V AC
<b>Output</b>					
Switch-on delay		≤ 15 ms	≤ 15 ms	≤ 15 ms	≤ 15 ms
Switch-off delay		≤ 10 ms	≤ 10 ms	≤ 10 ms	≤ 10 ms
<b>Ordering data</b>					
Without LED	Type	RCM270524	RCM270548	RCM270615	RCM270730
AgNi 90/10	Order No.	<b>8689760000</b>	<b>8689780000</b>	<b>8689800000</b>	<b>8689820000</b>
with LED	Type	RCM270R24		RCM270S15	RCM270T30
AgNi 90/10	Order No.	<b>8689770000</b>		<b>8689810000</b>	<b>8689830000</b>
	Type				
	Order No.				
	Type				
	Order No.				

<b>Note</b>					
-------------	--	--	--	--	--

**RIDERSERIES relay modules**

**RCM relay**

**3 CO contacts, AC/DC coil**

- 2500 VA switching capacity
- Solder and plug connection
- Safe-to-touch test button, selectable locking
- White labelling panel
- Identification of coils (AC red / DC blue)



**B**

**Circuit diagram**

Dimensions in mm

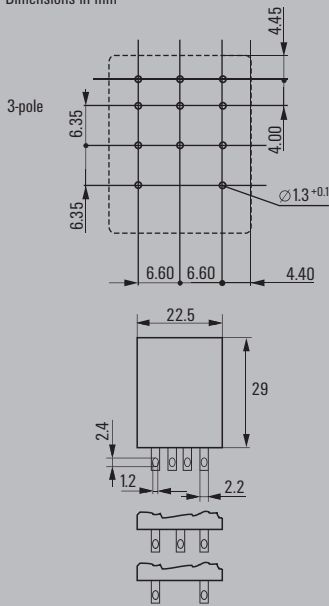

**Technical data**

Output	
Rated switching voltage / Continuous current	240 V AC / 10 A
Max. switching voltage, AC	400 V
Inrush current	20 A / 20 ms
Min. switching power	100 mA / 5 V, 10 V / 10 mA, 24 V / 1 mA
DC / AC Switching capacity (resistive), max.	240 W @ 24 V / 2500 VA
Contact material	AgNi 90/10
Mechanical service life	AC coil 20 x 10 <sup>6</sup> Switch. cycles, DC coil 30 x 10 <sup>6</sup> Switch. cycles
Max. switching frequency at rated load	0.1 Hz
Rated data	
Ambient temperature (operational)	-40 °C...70 °C
Storage temperature	-40 °C...85 °C
Humidity	40 °C / 93 % rel. humidity, no condensation
Approvals	CSA; cURus; EAC; VDE
Insulation coordination (EN 50178)	
Rated voltage	250 V
Impulse withstand voltage	5 kV (1.2/50 µs)
Dielectric strength input - output	2.5 KV <sub>eff</sub> / 1 min.
Dielectric strength, contact / contact	
Dielectric strength to mounting rail	
Creepage and clearance distance input - output	≥ 4 mm
Overvoltage category	III
Pollution degree	2
Dimensions	
Depth x width x height	mm 29 / 22.5 / 28
Plug-in connection	
Depth x width x height	mm 29 / 22.5 / 28
Note	

**Applications**

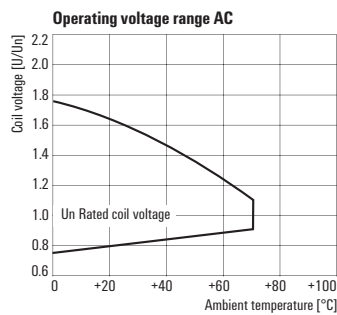
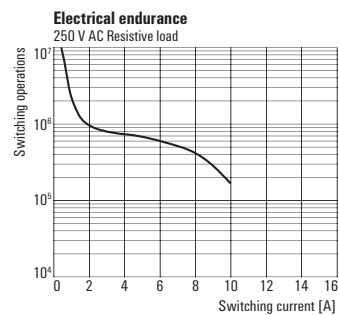
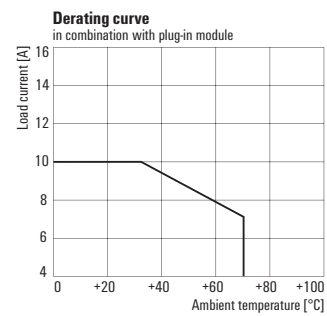
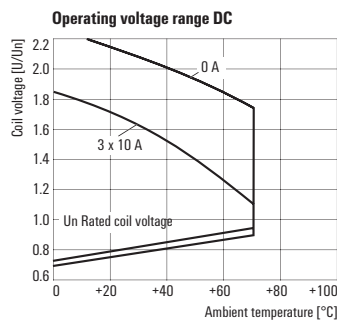
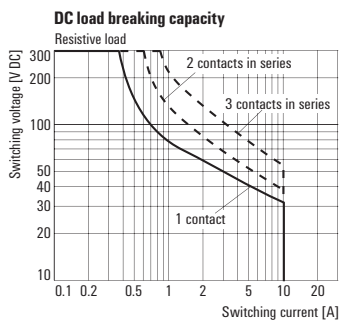





**RIDERSERIES relay modules**

**RCM relay**

**4 CO contacts, AC/DC coil**

- 1500 VA switching capacity
- Solder and plug connection
- AC/DC versions also with gold-plated contacts
- Safe-to-touch test button, selectable locking
- White labelling panel
- Identification of coils (AC red / DC blue)



**B**

**Circuit diagram**

Dimensions in mm

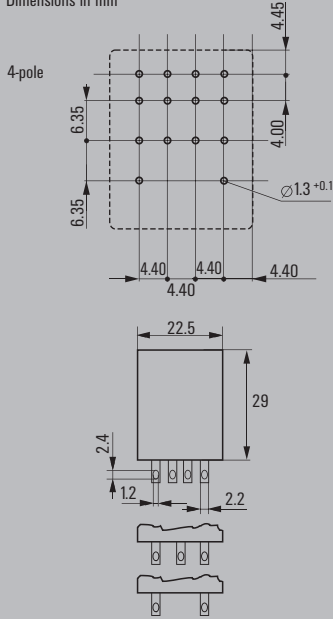

**Technical data**

Output	
Rated switching voltage / Continuous current	240 V AC / 6 A
Max. switching voltage, AC	240 V
Inrush current	12 A / 20 ms
Min. switching power	100 mA / 5 V, 10 V / 10 mA, 24 V / 1 mA
DC / AC Switching capacity (resistive), max.	144 W @ 24 V / 1500 VA
Contact material	AgNi 90/10
Mechanical service life	AC coil 20 x 10 <sup>6</sup> Switch. cycles, DC coil 30 x 10 <sup>6</sup> Switch. cycles
Max. switching frequency at rated load	0.1 Hz
Rated data	
Ambient temperature (operational)	-40 °C...70 °C
Storage temperature	-40 °C...85 °C
Humidity	40 °C / 93 % rel. humidity, no condensation
Approvals	CSA; cURus; EAC; VDE
Insulation coordination (EN 50178)	
Rated voltage	250 V
Impulse withstand voltage	5 kV (1.2/50 µs)
Dielectric strength input - output	2.5 KV <sub>eff</sub> / 1 min.
Dielectric strength, contact / contact	
Dielectric strength to mounting rail	
Creepage and clearance distance input - output	≥ 4 mm
Overvoltage category	III
Pollution degree	2
Dimensions	
Depth x width x height	mm 29 / 22.5 / 28
Plug-in connection	
Depth x width x height	mm 29 / 22.5 / 28
Note	

**Applications**

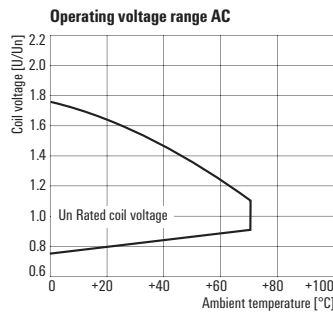
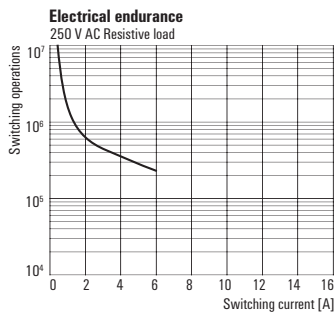
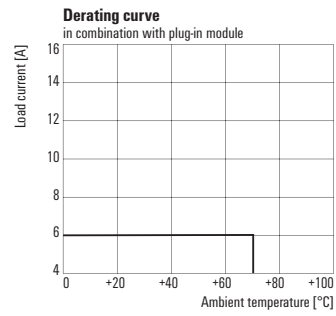
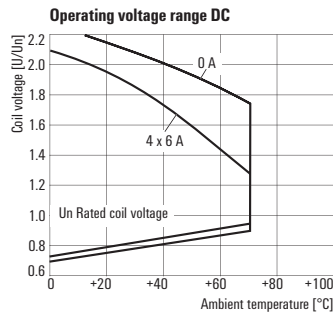
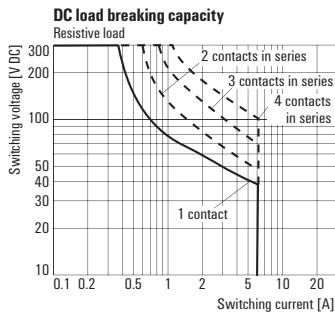



## Signal monitoring in safety-critical circuits

### Coupling relays with positively driven contacts

Weidmüller has expanded the RIDERSERIES to include a relay variant with force-guided contacts. Relays with force-guided contacts have a 99 % diagnostics coverage and an excellent reputation for use in safety systems. The contacts interlock mechanically with each other in order to ensure a synchronous switching status of both contacts. This guarantees that the alert contact will maintain the same switching status in the event of an error (for example, if the working contact melts from an overload). The controller (or safety controller) detects the alert contact and then compares the set point and actual values. If a difference occurs, measures can then be taken to protect equipment and human life.

### Resistant to vibration

A metal clip ensures that the relay module remains secure even under vibration / mechanical shock conditions.

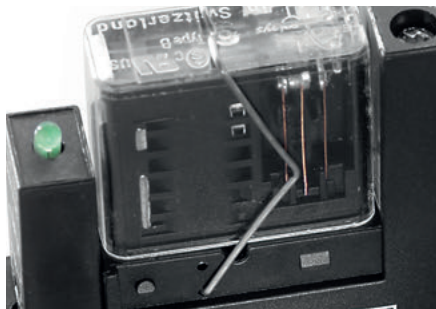
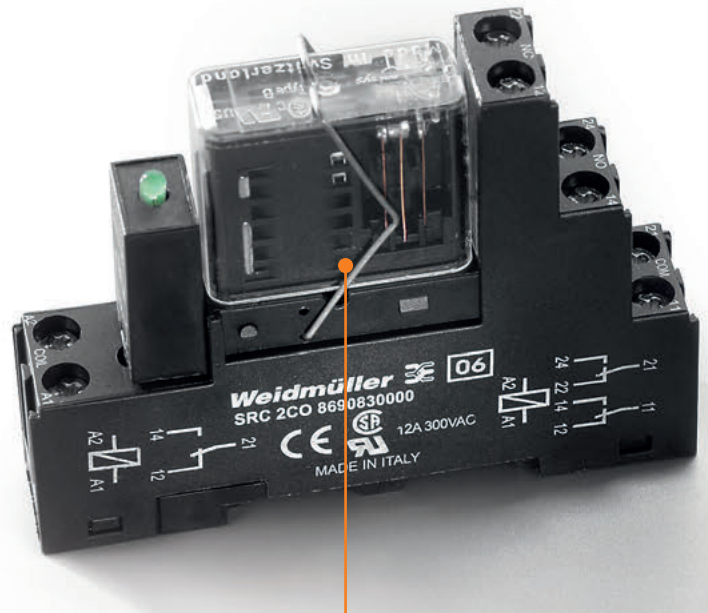

### A variety of connection options

The base is available either with the proven screw clamp connection or the time saving tension clamp connection.

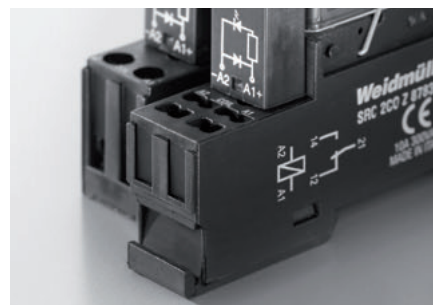

**Convenient**

Relay modules can be replaced quickly in the event of a fault without removing the connecting cable.

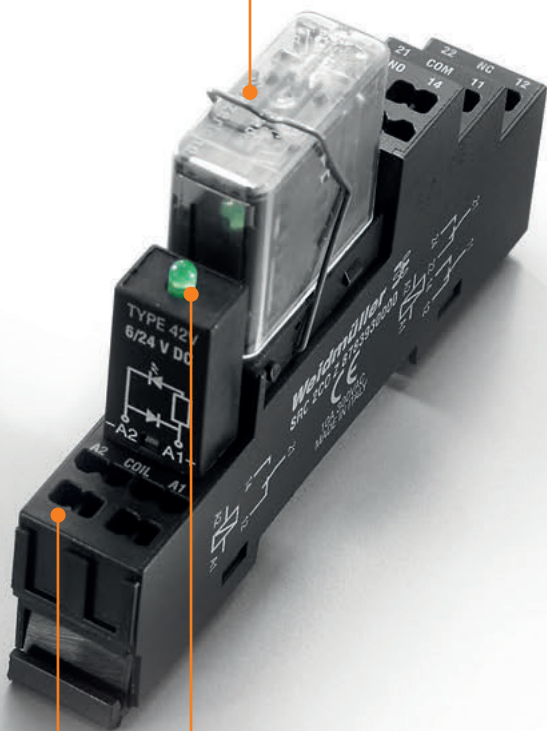

**On site diagnostics**

An easy to view LED display module with an integrated free wheeling diode is used to protect the series connected electronics.

**Safety-based output relay controls**

By connecting two coupling relays together with a safety based controller or safety switching devices, it is possible to set up a safe and efficient control mechanism that complies with the structure specified in EN ISO 13849-1 (Category 3 and 4).

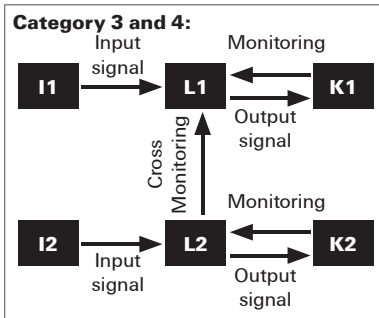

**RIDERSERIES FG relay modules**

**RCI KIT with forcibly guided contacts**

**2 CO DC coil**

Modular system comprising of:

- Relay socket for rail mounting
- LED indicator unit
- Retaining clip
- Pluggable relay modules
- Markers



**B**

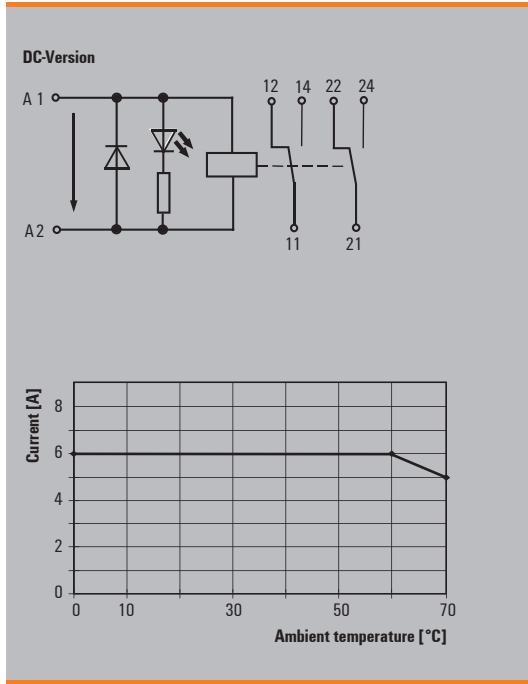

**Technical data**

Output			
Rated switching voltage / Continuous current	250 V AC / 6 A		
Max. switching voltage, AC	250 V		
Inrush current	15 A / 20 ms		
Min. switching power	100 mA / 5 V, 10 V / 10 mA, 24 V / 1 mA		
DC / AC Switching capacity (resistive), max.	144 W @ 24 V / 1500 VA		
Contact material	AgCuNi		
Mechanical service life	> 50 x 10 <sup>8</sup> switching cycles		
Max. switching frequency at rated load	0.1 Hz		
Rated data			
Ambient temperature (operational)	-40 °C...70 °C		
Storage temperature	-40 °C...85 °C		
Humidity	40 °C / 95 % rel. humidity, no condensation		
Approvals	CE, EAC		
Insulation coordination (EN 50178)			
Rated voltage	250 V		
Impulse withstand voltage			
Dielectric strength input - output	2.5 KV <sub>eff</sub> / 1 min.		
Dielectric strength, contact / contact			
Dielectric strength to mounting rail			
Creepage and clearance distance input - output	≥ 10 mm		
Overvoltage category	III		
Pollution degree	3		
Dimensions		Screw connection	Tension clamp connection
Clamping range (nominal / min. / max.)	mm <sup>2</sup>	2.5 / 0.5 / 2.5	1.5 / 0.5 / 1.5
Depth x width x height	mm	62 / 15.5 / 77	63.2 / 16 / 97
Note			

**Ordering data**

Input		24 V DC 2CO LED	
Rated control voltage		24 V DC	
Rated current AC / DC		/ 31.6 mA	
Power rating		700 mW	
Pull-in/drop-out voltage, typ.		18 V / 2.4 V DC	
Status indicator		Green LED	
Protective circuit		Integrated free-wheel diode	
Output			
Switch-on delay		≤ 12 ms	
Switch-off delay		≤ 6 ms	

Ordering data		RCIKIT 24VDC 2CO LD/FG	
Screw connection	Type	RCIKIT 24VDC 2CO LD/FG	
	Order No.	1218410000	
Tension clamp conn.	Type	RCIKITZ 24VDC 2CO LD/FG	
	Order No.	1218390000	

Ordering data		RCI42424FG	
Spare relay	Type	RCI42424FG	
	Order No.	1218380000	

Note	

# Power electronics

---

<b>Power electronics</b>	Power solid-state relays - Overview	C.2
	Power solid-state relays	C.4

---

# Power solid state relays

## Switch high AC loads up to 75 A completely wear-free and noiseless

C

**Your applications require switching capacities that conventional relays cannot handle? Our power solid state relays have an unrestricted service life – even in extreme environments. Let's connect.**

Due to their high shock and vibration resistance, the large switching current and the option of simple fusing, our power solid state relays outperform by far any electromagnetic relays, especially in the process industry.

The compact modules have low power drive requirements, fast response times and operate odourless. The optional 1PH-Control-Unit allows the current monitoring of up to five parallel connected loads.

Our new power solid state relays are ideally suited for a multitude of diverse tasks: switching pipe trace heating, phase controls for motors and infrared heating, and permanent current monitoring.

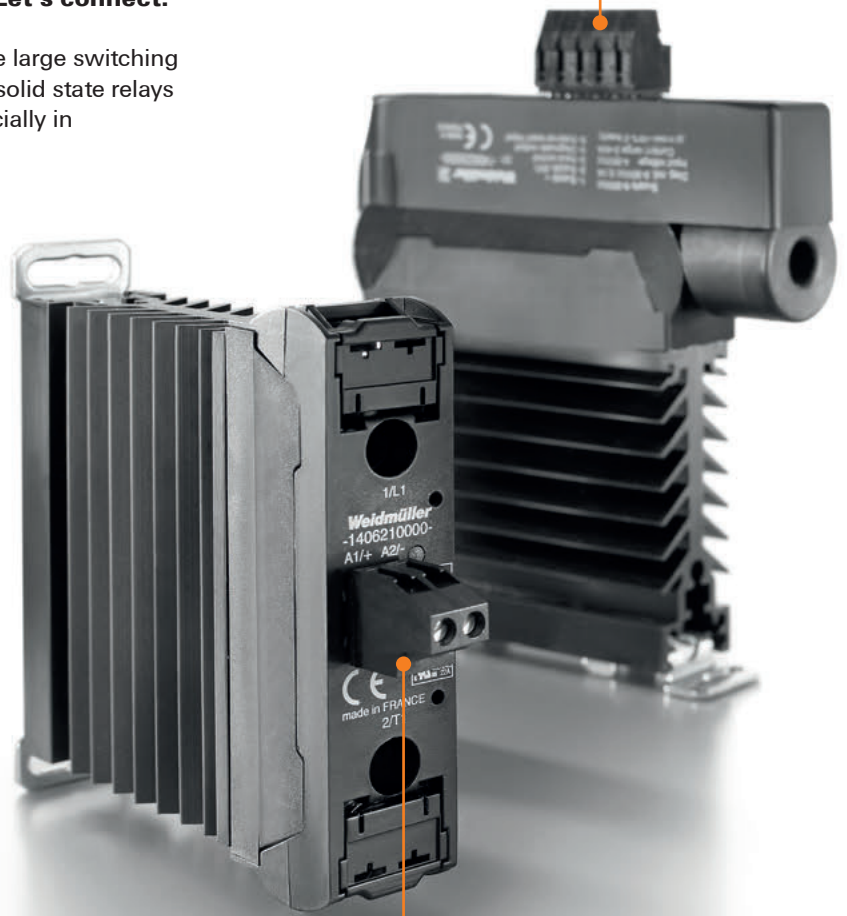

**High current load integral**

The high current load integral I<sup>2</sup>t of 6,000 A<sup>2</sup>s allows affordable conductor protection using standard circuit breakers for variants with 35 A load current.

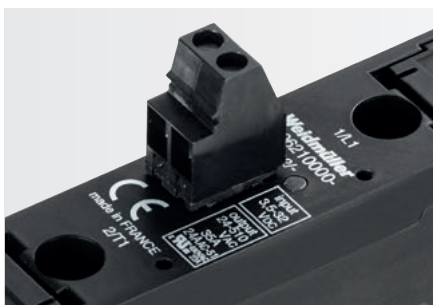



**Simple current monitoring**

The optional, plug-on monitoring module warns when current drops by 16 % or more. Short-circuit, line-break and defective loads are detected.



**Simple current control**

The 70 A phase control with analog input (4 – 20 mA) allows you to set up heating controls or the power control of single-phase motors.



**High output current**

Ideal for controlling pipe trace heating due to the high output current of 50 or 75 A. The compact design allows directing mounting at application site.





Power solid state relays

PSSR - 1-phase

- Single-phase load circuit: 12-275 V AC / 25 A
- Ready-to-use: simply clip on and connect
- Zero-cross switch
- Noiseless, wear-free switching
- Attachable monitoring module

PSSR 24 V DC / 1 PH AC 25 A

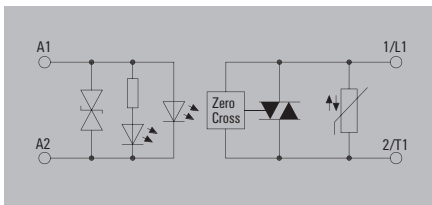

Technical data

Control side	
Rated control voltage	3.5...32 V DC
Power rating	≤ 280 mW
Cut-in / dropout voltage	3 V / 2 V DC
Input frequency	10 Hz
Status indicator	LED yellow
Protective circuit	Suppressor diode
Load side	
Solid-state type	Triac (zero-cross switch)
Rated switching voltage	12...275 V AC
Continuous current	20 A (AC 51) @ 40 °C, 3.5 A (AC 53)
Min. switching current	5 mA
Max. switching current	25 A
Voltage drop at max. load	0.85 V
Leakage current	< 1 mA
Short-circuit-proof / Protective circuit, load side	No / Varistor
Switch-on delay / Switch-off delay	≤ 10 ms / ≤ 10 ms
Output voltage frequency range	50 / 60 Hz
Pulse load, max. current	140 A (10 ms)
Load category	AC 51, AC 53
Load limit integral (I²t) <10 ms	340 A²s
General data	
Ambient temperature (operational)	-55 °C...100 °C
Storage temperature	-55 °C...125 °C
Humidity	40...85 % (indoor) no condensation
Approvals	CE: cURus; EAC
Standards	EN 60947-4-3, EN 60950, IEC 60335-1
Insulation coordination (EN 50178)	
Impulse withstand voltage	4 kV (1.2/50 µs)
Clearance and creepage distances for control side - load side	≥ 8 mm
Overvoltage category	III
Pollution degree	2

Dimensions	
Clamping range (rated / min. / max.) control side	mm² 1.5 / 0.13 / 3.3
Clamping range (rated / min. / max.) load side	mm² 10 / 1.5 / 10
Depth x width x height	mm 119.5 / 22.5 / 97
Note	

Ordering data

Screw connection
------------------

<b>Note</b>	Accessories and dimensioned drawings: refer to the Power Solid-state Relay Accessories page.
-------------	--

Accessories

<b>Note</b>	
-------------	--

Type		
Type	Qty.	Order No.
PSSR 24VDC/1PH AC 25A	1	1406200000

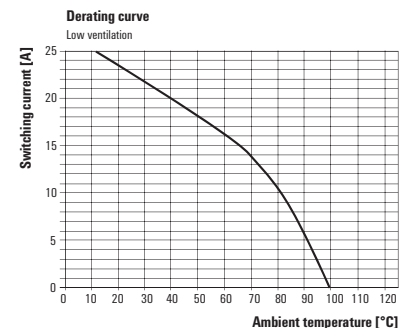
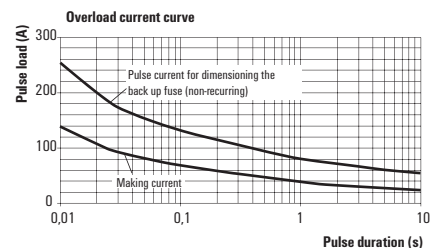

**PSSR - 1-phase**

- Single-phase load circuit: 12-275 V AC / 25 A
- Ready-to-use: simply clip on and connect
- Zero-cross switch
- Noiseless, wear-free switching
- Attachable monitoring module

**PSSR 230 V AC / 1 PH AC 25 A**

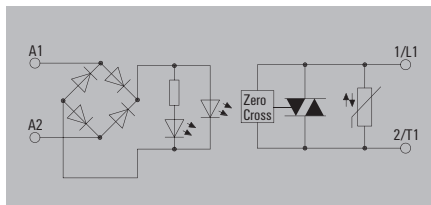

**Technical data**

Control side	
Rated control voltage	160...240 V AC/DC
Power rating	≤ 1.38 VA
Cut-in / dropout voltage	160 V / 5 V AC 160 V / 5 V DC
Input frequency	10 Hz
Status indicator	LED yellow
Protective circuit	Rectifier
Load side	
Solid-state type	Triac (zero-cross switch)
Rated switching voltage	12...275 V AC
Continuous current	20 A (AC 51) @ 40 °C, 3.5 A (AC 53)
Min. switching current	5 mA
Max. switching current	25 A
Voltage drop at max. load	0.85 V
Leakage current	< 1 mA
Short-circuit-proof / Protective circuit, load side	No / Varistor
Switch-on delay / Switch-off delay	≤ 30 ms / ≤ 30 ms
Output voltage frequency range	50 / 60 Hz
Pulse load, max. current	140 A (10 ms)
Load category	AC 51, AC 53
Load limit integral (I <sup>2</sup> t) <10 ms	340 A <sup>2</sup> s
General data	
Ambient temperature (operational)	-55 °C...100 °C
Storage temperature	-55 °C...125 °C
Humidity	40...85 % (indoor) no condensation
Approvals	CE; cURus; EAC
Standards	EN 60947-4-3, EN 60950, IEC 60335-1
Insulation coordination (EN 50178)	
Impulse withstand voltage	4 kV (1.2/50 μs)
Clearance and creepage distances for control side - load side	≥ 8 mm
Overvoltage category	III
Pollution degree	2
Dimensions	
Clamping range (rated / min. / max.) control side	mm <sup>2</sup> 1.5 / 0.13 / 3.3
Clamping range (rated / min. / max.) load side	mm <sup>2</sup> 10 / 1.5 / 10
Depth x width x height	mm 119.5 / 22.5 / 97
Note	

Type	Qty.	Order No.
PSSR 230VAC/1PH AC 25A	1	1406220000

**Ordering data**

Screw connection
------------------

**Note**

Accessories and dimensioned drawings: refer to the Power Solid-state Relay Accessories page.

**Accessories**

<b>Note</b>
-------------

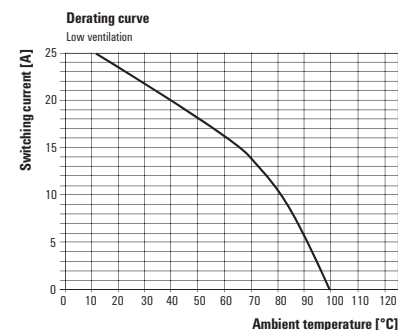
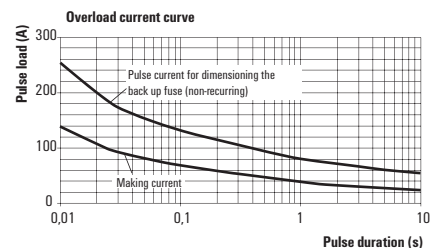

## Power solid state relays

## PSSR - 1-phase

- Single-phase load circuit: 24–600 V AC / 35 A
- Ready-to-use: simply clip on and connect
- Zero-cross switch
- Noiseless, wear-free switching
- Attachable monitoring module
- High capacity for handling surge currents  $I^2t = 6000$  A<sup>2</sup>s (10 ms)
- Fusing with B circuit breaker possible

## PSSR 24 V DC / 1 PH AC 35 A

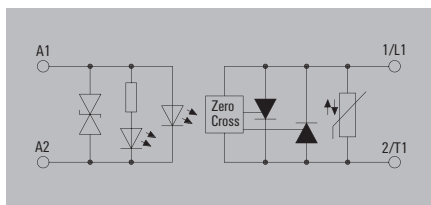

## Technical data

## Control side

Rated control voltage  
Power rating  
Cut-in / dropout voltage  
Input frequency  
Status indicator  
Protective circuit

## Load side

Solid-state type  
Rated switching voltage  
Continuous current  
Min. switching current  
Max. switching current  
Voltage drop at max. load  
Leakage current  
Short-circuit-proof / Protective circuit, load side  
Switch-on delay / Switch-off delay  
Output voltage frequency range  
Pulse load, max. current  
Load category  
Load limit integral ( $I^2t$ ) <10 ms

## General data

Ambient temperature (operational)  
Storage temperature  
Humidity  
Approvals  
Standards

## Insulation coordination (EN 50178)

Impulse withstand voltage  
Clearance and creepage distances for control side - load side  
Overvoltage category  
Pollution degree

3.5...32 V DC

≤ 280 mW

3 V / 2 V DC

10 Hz

LED yellow

Suppressor diode

Thyristor (zero-cross switch)

24...600 V AC

24 A (AC 51) @ 40°C, 7 A (AC 53)

5 mA

50 A

&lt; 1 V

&lt; 1 mA

No / Varistor

≤ 10 ms / ≤ 10 ms

50 / 60 Hz

600 A (10 ms)

AC 51, AC 53

6000 A<sup>2</sup>s

-55 °C...100 °C

-55 °C...125 °C

40...85 % (indoor) no condensation

CE: cURus; EAC

EN 60947-4-3, EN 60950, IEC 60335-1

4 kV (1.2/50 μs)

≥ 8 mm

III

2

## Dimensions

Clamping range (rated / min. / max.) control side mm<sup>2</sup>  
Clamping range (rated / min. / max.) load side mm<sup>2</sup>  
Depth x width x height mm

## Note

1.5 / 0.13 / 3.3

10 / 1.5 / 10

119.5 / 22.5 / 97

## Ordering data

Screw connection

Type	Qty.	Order No.
PSSR 24VDC/1PH AC 35A	1	1406210000

## Note

Accessories and dimensioned drawings: refer to the Power Solid-state Relay Accessories page.

## Accessories

## Note

Overload current curve

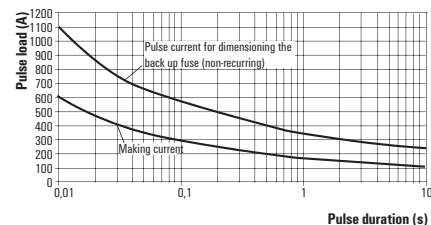

Derating curve

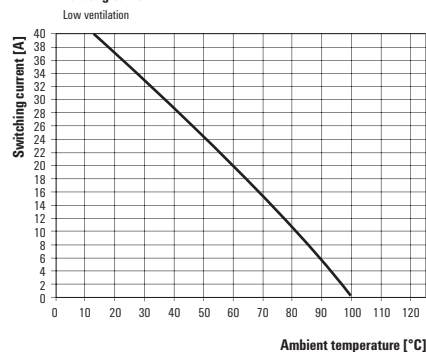

**PSSR control unit**

- Monitoring of up to 5 consumers connected in parallel
- Can be attached to the single-phase PSSRs
- Error message feedback output
- Undercurrent switching threshold:  $0.84 \times I_{teach}$
- Teach button on the module and external teach input

**PSSR 1 PH CONTROL UNIT**

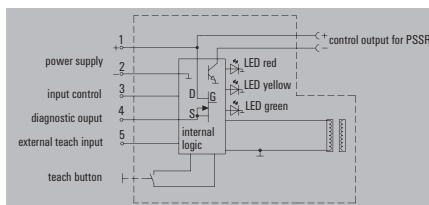

**Technical data**

<b>Control side</b>	
Rated control voltage	4...30 V DC
Nominal control current	≤ 2.5 mA
Cut-in / dropout voltage	2 V DC
Rated control voltage (external teach input)	4...30 V DC
Nominal control current (external teach input)	≤ 2.5 mA
<b>Supply</b>	
Supply voltage	8...30 V DC
Current consumption	≤ 150 mA
<b>Feedback output</b>	
Solid-state type	MOS-FET
Nominal switching voltage	8...30 V DC
Continuous current	0.1 A
Undercurrent switching threshold	$0.84 \times I_{teach}$
Current measurement range AC, min.	2 A
Current measurement range AC, max.	40 A
Switch-on delay	≤ 100 ms
Switch-off delay	≤ 100 ms
<b>Control output to the PSSR</b>	
Rated switching voltage	
Solid-state type	
Switch-on delay	
Switch-off delay	
<b>General data</b>	
Ambient temperature (operational)	-40 °C...80 °C
Storage temperature	-40 °C...125 °C
Humidity	40...85 % (indoor) no condensation
Current sensor hole diameter	9 mm
Approvals	CE, EAC
Standards	EN 60947-4-3, EN 60950
<b>Insulation coordination (EN 50178)</b>	
Impulse withstand voltage	4 kV (1.2/50 μs)
Clearance and creepage distances for control side - load side	≥ 8 mm
Overvoltage category	III
Pollution degree	2
<b>Dimensions</b>	
Clamping range (nominal / min. / max.)	mm <sup>2</sup>
Depth x width x height	mm
<b>Note</b>	
<b>Screw connection</b>	
	1.5 / 0.15 / 2.5
	65 / 25 / 112
<b>Note</b>	

**Ordering data**

Type	Qty.	Order No.
PSSR 1PH CONTROL UNIT	1	1406230000

**Note** Accessories and dimensioned drawings: refer to the Power Solid-state Relay Accessories page.

**Accessories**

**Note**

Power solid state relays

PSSR - 1-phase

- Single-phase load circuit: 24–600 V AC / 50 A
- Compact design
- Zero-cross switch
- Noiseless, wear-free switching

PSSR 24 V DC / 1 PH AC 50 A HP

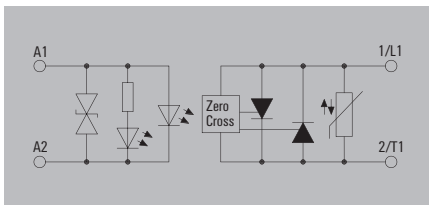

Technical data

Control side

- Rated control voltage
- Power rating
- Cut-in / dropout voltage
- Input frequency
- Status indicator
- Protective circuit

Load side

- Solid-state type
- Rated switching voltage
- Continuous current
- Min. switching current
- Max. switching current
- Voltage drop at max. load
- Leakage current
- Short-circuit-proof / Protective circuit, load side
- Switch-on delay / Switch-off delay
- Output voltage frequency range
- Pulse load, max. current
- Load category
- Load limit integral (I<sup>2</sup>t) <10 ms

General data

- Ambient temperature (operational)
- Storage temperature
- Humidity
- Approvals
- Standards

Insulation coordination (EN 50178)

- Impulse withstand voltage
- Clearance and creepage distances for control side - load side
- Overvoltage category
- Pollution degree

Dimensions

- Clamping range (rated / min. / max.) control side mm<sup>2</sup>
- Clamping range (rated / min. / max.) load side mm<sup>2</sup>
- Depth x width x height mm

Note

Ordering data

Screw connection

3.5...32 V DC

≤ 280 mW

3 V / 2 V DC

10 Hz

Green LED

Suppressor diode

Thyristor (zero-cross switch)

24...600 V AC

50 A (AC 51)

5 mA

60 A

< 1 V

< 1 mA

No / Varistor

≤ 10 ms / ≤ 10 ms

50 / 60 Hz

400 A (10 ms)

AC 51

2450 A<sup>2</sup>s

-55 °C...100 °C

-55 °C...125 °C

40...85 % (indoor) no condensation

CE: cURus; EAC

EN 60947-4-3, EN 60950, IEC 60335-1

4 kV (1.2/50 µs)

≥ 8 mm

III

2

1.5 / 0.75 / 2.5

10 / 1.5 / 10

29 / 45 / 58.5

Type	Qty.	Order No.
PSSR 24VDC/1PH AC50A HP	2	1406240000

Note

Accessories and dimensioned drawings: refer to the Power Solid-state Relay Accessories page.

Accessories

Note

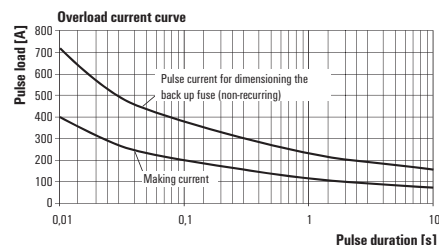

**PSSR - 1-phase**

- Single-phase load circuit: 24–600 V AC / 75 A
- Compact design
- Zero-cross switch
- Noiseless, wear-free switching
- High capacity for handling surge currents  $I^2t = 6000 \text{ A}^2\text{s}$  (10 ms)
- Fusing with B circuit breaker possible

**PSSR 24 V DC / 1 PH AC 75 A HP**

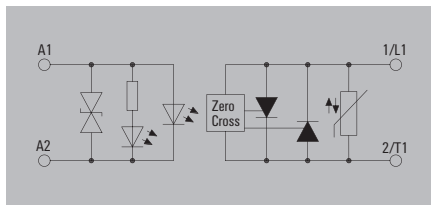

**Technical data**

<b>Control side</b>	
Rated control voltage	3.5...32 V DC
Power rating	≤ 280 mW
Cut-in / dropout voltage	3 V / 2 V DC
Input frequency	10 Hz
Status indicator	Green LED
Protective circuit	Suppressor diode
<b>Load side</b>	
Solid-state type	Thyristor (zero-cross switch)
Rated switching voltage	24...600 V AC
Continuous current	75 A (AC 51)
Min. switching current	5 mA
Max. switching current	90 A
Voltage drop at max. load	< 1 V
Leakage current	< 1 mA
Short-circuit-proof / Protective circuit, load side	No / Varistor
Switch-on delay / Switch-off delay	≤ 10 ms / ≤ 10 ms
Output voltage frequency range	50 / 60 Hz
Pulse load, max. current	600 A (10 ms)
Load category	AC 51
Load limit integral ( $I^2t$ ) <10 ms	6000 A <sup>2</sup> s
<b>General data</b>	
Ambient temperature (operational)	-55 °C...100 °C
Storage temperature	-55 °C...125 °C
Humidity	40...85 % (indoor) no condensation
Approvals	CE: cURus; EAC
Standards	EN 60947-4-3, EN 60950, IEC 60335-1
<b>Insulation coordination (EN 50178)</b>	
Impulse withstand voltage	4 kV (1.2/50 μs)
Clearance and creepage distances for control side - load side	≥ 8 mm
Overvoltage category	III
Pollution degree	2

<b>Dimensions</b>	
Clamping range (rated / min. / max.) control side	mm <sup>2</sup> 1.5 / 0.75 / 2.5
Clamping range (rated / min. / max.) load side	mm <sup>2</sup> 10 / 1.5 / 10
Depth x width x height	mm 29 / 45 / 58.5
<b>Note</b>	

**Ordering data**

Screw connection
------------------

Type	Qty.	Order No.
PSSR 24VDC/1PH AC75A HP	2	1406250000

<b>Note</b>	Accessories and dimensioned drawings: refer to the Power Solid-state Relay Accessories page.
-------------	--

**Accessories**

<b>Note</b>	
-------------	--

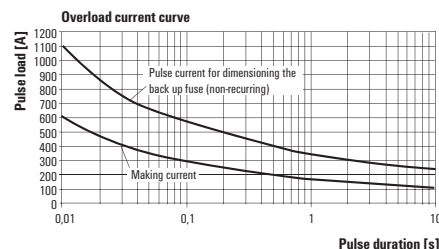

Power solid state relays

PSSR - 1-phase

- Single-phase load circuit: 200-460 VAC / 70 A
- 4-20 mA control input
- Manual phase angle adjustment
- Noiseless, wear-free switching

PSSR 20 MA / 1 PH AC 70 A PC

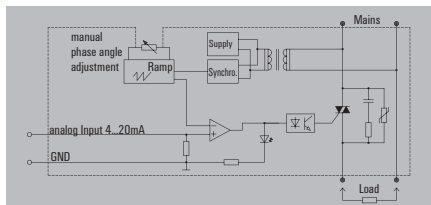

Technical data

<b>Control side</b>	
Nominal control current	4...20 mA ±15 %
<b>Load side</b>	
Solid-state type	Triac
Rated switching voltage	200...460 V AC
Continuous current	70 A
Min. switching current	10 mA
Max. switching current	
Voltage drop at max. load	≤ 1.6 V
Leakage current	< 5 mA
Short-circuit-proof / Protective circuit, load side	No / RC combination with varistor
Switch-on delay / Switch-off delay	≤ 10 ms / ≤ 50 ms
Output voltage frequency range	47-100 Hz (manual phase angle adjustment necessary)
Pulse load, max. current	870 A (10 ms)
Load category	AC 51
Load limit integral (I²t) <10 ms	5000 A²s
<b>General data</b>	
Ambient temperature (operational)	-40 °C...85 °C
Storage temperature	-40 °C...85 °C
Humidity	40...85 % (indoor) no condensation
Approvals	CE, EAC
Standards	EN 60947-4-3, EN 60950
<b>Insulation coordination</b>	
Impulse withstand voltage	4 kV (1.2/50 µs)
Clearance and creepage distances for control side - load side	≥ 8 mm
Overvoltage category	III
Pollution degree	2

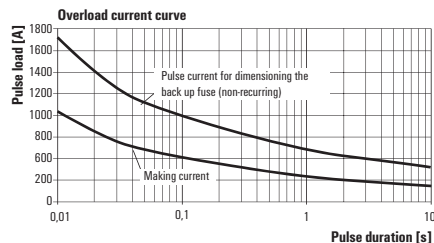

<b>Dimensions</b>	
Conductor connection (control side)	M3 ring cable lug (insulated)
Conductor connection (load side)	M5 ring cable lug (insulated)
Depth x width x height	39.5 / 100 / 73.5 mm
<b>Note</b>	

Ordering data

Screw connection
------------------

Type	Qty.	Order No.
PSSR 20MA/1PH AC70A PC	1	1406270000

<b>Note</b>	Accessories and dimensioned drawings: refer to the Power Solid-state Relay Accessories page.
-------------	--

Accessories

<b>Note</b>	
-------------	--

Power loss and selection of heat sink

Order No. 1406240000

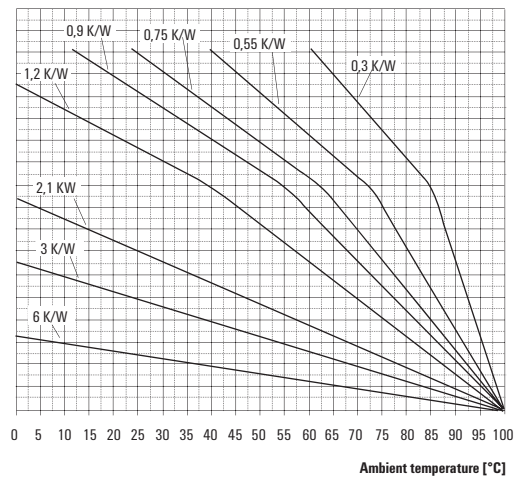
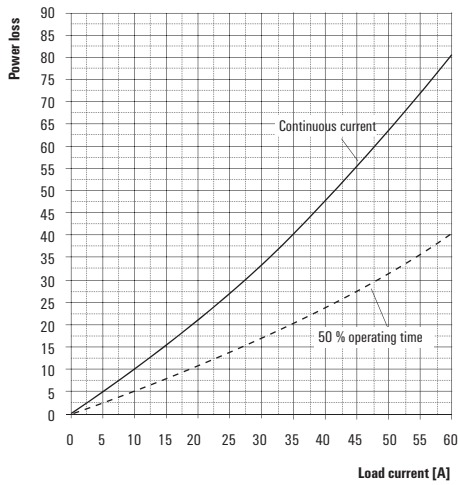

Order No. 1406250000

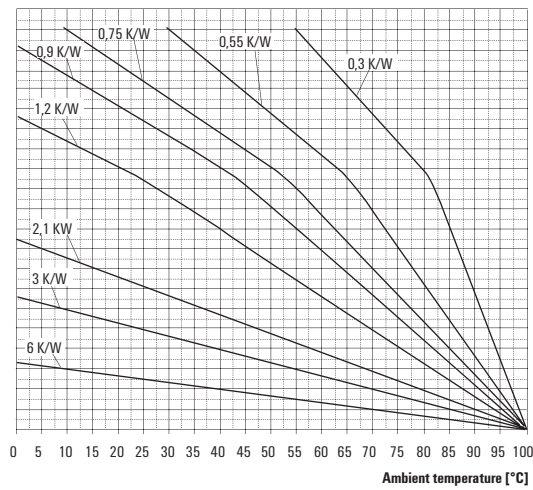
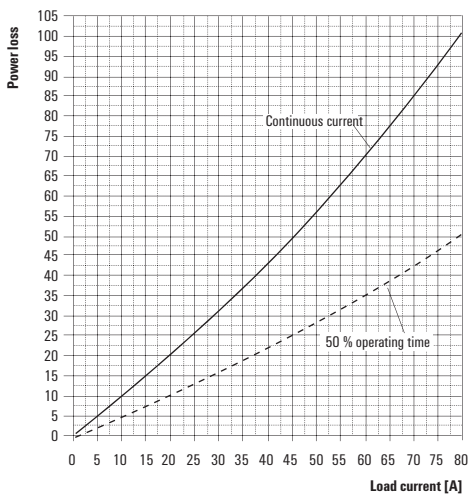

Order No. 1406270000

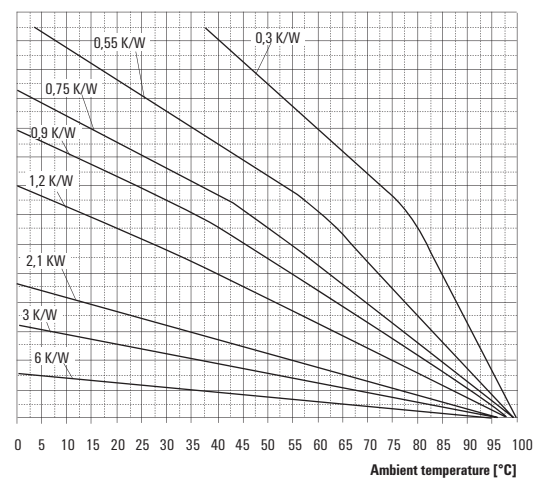
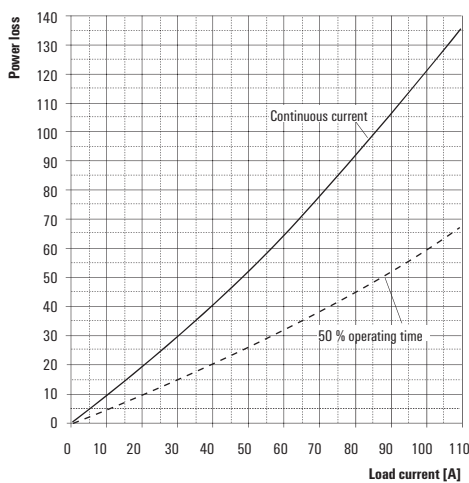



Power solid-state relays

PSSR - 3-phase

- Three-phase load circuit 24...520 V AC / 20 A at 55°C
- Ready-to-use: snap on - connect - ready
- Zero-cross switch
- Wear-free and noiseless switching

PSSR 24 V DC / 3 PH AC 20 A

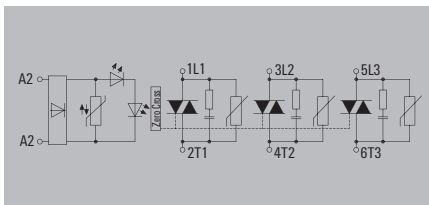

Technical data

Control side	
Rated control voltage	8...30 V DC / 10...30 V AC
Power rating	0.1...2 W
Cut-in / dropout voltage	10 V / 4 V AC 8 V / 4 V DC
Input frequency	10 Hz
Status indicator	Green LED
Protective circuit	RC element, Varistor
Load side	
Solid-state type	Triac (zero-cross switch)
Rated switching voltage	24...520 V AC
Continuous current	20 A
Min. switching current	5 mA
Max. switching current	
Voltage drop at max. load	1.4 V
Leakage current	< 1 mA
Short-circuit-proof / Protective circuit	No / RC element, Varistor
Switch-on delay / Switch-off delay	30 ms / 30 ms
Output voltage frequency range	50 / 60 Hz
Pulse load, max. current / Cartridge fuse	300 A (10 ms) / FERRAZ gRC 63 A 22x58 1353 A <sup>2</sup> s
Load category	AC 53: 3 x 12 A
Load limit integral (I <sup>2</sup> t) <10 ms	1500 A <sup>2</sup> s
General data	
Ambient temperature (operational)	-40 °C...80 °C
Storage temperature	-40 °C...100 °C
Humidity	40...85 % (indoor) no condensation
Approvals	cURus; EAC
Standards	DIN EN 60950, IEC 60947-4-3
Insulation coordination	
Rated voltage	300 V
Impulse withstand voltage	4 kV
Clearance and creepage distances for control side - load side	≥ 6.4 mm
Overvoltage category	III
Pollution degree	2
Dimensions	
Clamping range (rated / min. / max.) control side	mm <sup>2</sup> 1.5 / 0.75 / 2.5
Clamping range (rated / min. / max.) load side	mm <sup>2</sup> 10 / 10 / 1.5
Depth x width x height	mm 126.2 / 89.6 / 98
Note	

Ordering data

Type	Qty.	Order No.
PSSR 24VDC/3PH AC 20A	1	8952130000

**Note** Accessories and dimensioned drawings: refer to the Power Solid-state Relay Accessories page.

Accessories

**Note**

Derating curve with moderate ventilation and 50 % operational running time

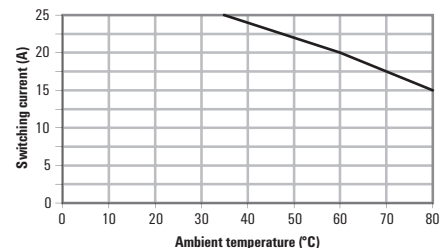

Derating curve without ventilation and in continual operation

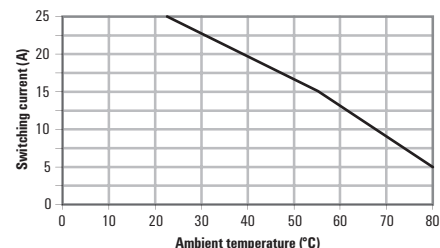

**PSSR - 3-phase**

- Three-phase load circuit 24...520 V AC / 20 A at 55°C
- Ready-to-use: snap on - connect - ready
- Zero-cross switch
- Wear-free and noiseless switching

**PSSR 230 V AC / 3 PH AC 20 A**

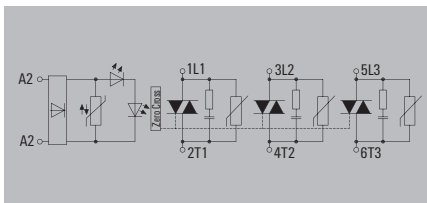

**Technical data**

Control side	
Rated control voltage	90...240 V AC / DC
Power rating	0.4...2.6 W
Cut-in / dropout voltage	90 V / 15 V AC 90 V / 15 V DC
Input frequency	10 Hz
Status indicator	Green LED
Protective circuit	RC element, Varistor
Load side	
Solid-state type	Triac (zero-cross switch)
Rated switching voltage	24...520 V AC
Continuous current	20 A
Min. switching current	5 mA
Max. switching current	
Voltage drop at max. load	1.4 V
Leakage current	< 1 mA
Short-circuit-proof / Protective circuit	No / RC element, Varistor
Switch-on delay / Switch-off delay	30 ms / 30 ms
Output voltage frequency range	50 / 60 Hz
Pulse load, max. current / Cartridge fuse	300 A (10 ms / FERRAZ gRC 63 A 22x58 1353 A <sup>2</sup> s)
Load category	AC 53: 3 x 12 A
Load limit integral (I <sup>2</sup> t) <10 ms	1500 A <sup>2</sup> s
General data	
Ambient temperature (operational)	-40 °C...80 °C
Storage temperature	-40 °C...100 °C
Humidity	40...85 % (indoor) no condensation
Approvals	cURus; EAC
Standards	DIN EN 60950, IEC 60947-4-3
Insulation coordination	
Rated voltage	300 V
Impulse withstand voltage	4 kV
Clearance and creepage distances for control side - load side	≥ 6.4 mm
Overvoltage category	III
Pollution degree	2
Dimensions	
Clamping range (rated / min. / max.) control side	mm <sup>2</sup> 1.5 / 0.75 / 2.5
Clamping range (rated / min. / max.) load side	mm <sup>2</sup> 10 / 1.5 / 10
Depth x width x height	mm 126.2 / 89.6 / 98
Note	

**Ordering data**

Type	Qty.	Order No.
PSSR 230VAC/3PH AC 20A	1	8952140000

Note
Accessories and dimensioned drawings: refer to the Power Solid-state Relay Accessories page.

**Accessories**

Note

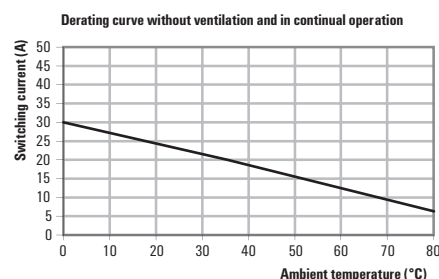
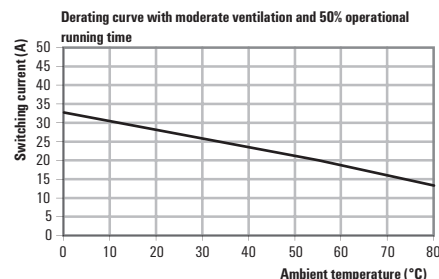
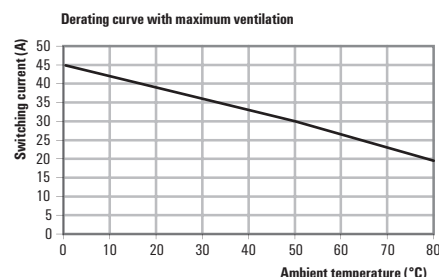

Dimensioned drawing for PSSR, single-phase

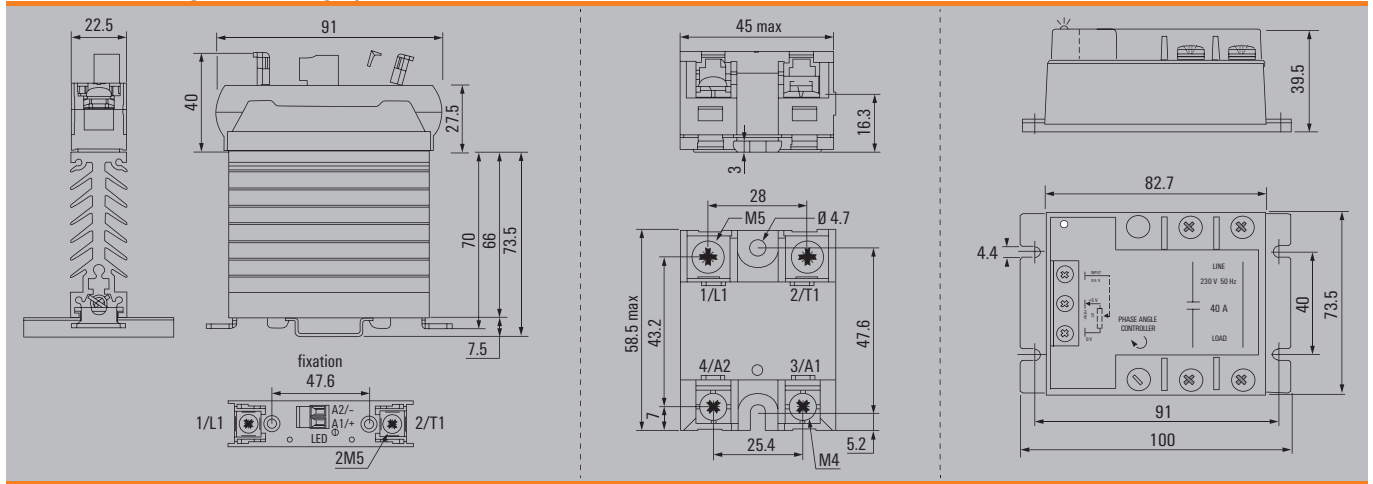

Dimensioned drawing for PSSR, three-phase

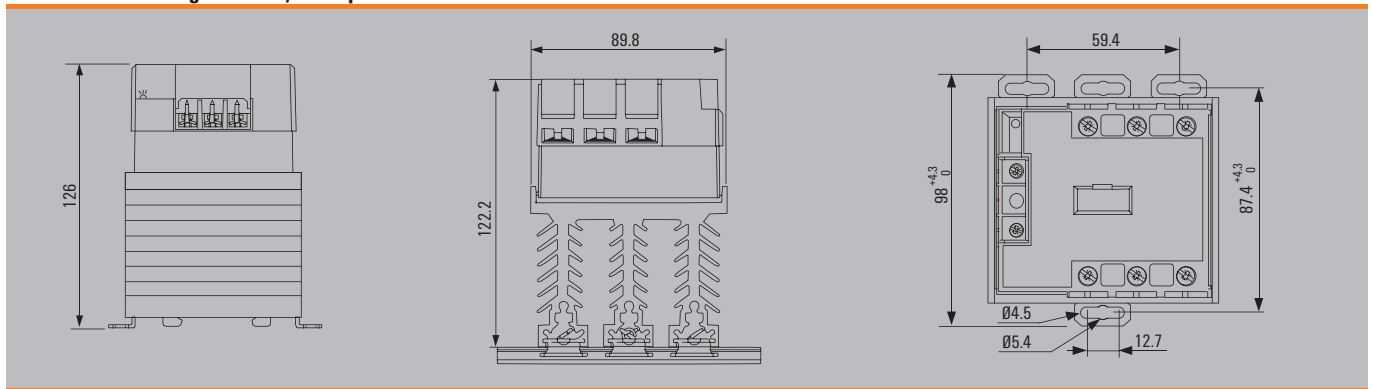

Uninsulated screwdriver

Weidmüller SoftFinish screwdriver for general uses. Blade made from fully hardened, high-alloy chromium-vanadium-molybdenum steel, matt chrome finish.

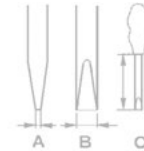

SD S

Slotted screwdriver with rounded blade SD DIN 5265, ISO 2380/2, output to DIN 5264, ISO 2380/1. ChromTop tip, SoftFinish® grip

Type	Size / AF	A	B	C	Order No.
SD 0.5x3.0x80		0.5	3.0	80	9008320000



SDK PZ

Crosshead screwdriver, Pozidriv, SDK PZ DIN 5262, ISO 8764/2-PZ, output to ISO 8764/1-PZ, ChromTop tip, SoftFinish® grip

SDK PZ2	2			100	9008540000
---------	---	--	--	-----	------------



# Safety relay

---

<b>Safety relay</b>	SAFESERIES SIL relays - Overview	D.2
	SAFESERIES SIL relays	D.6

---

# SAFESERIES SIL relays

## Functional safety for process applications

**When dealing with the core elements of a system with a large risk potential, it is especially critical to have the best system solution in place. Our SIL relays reliably switch off your systems in critical situations – and they have all been accredited. Let's connect.**

Whether for a burner control system, secure emergency shut down or, for example, for pump controllers – our safety relay guarantees safe conditions and encompasses highly superior and significant features.

**D**

Their integration into distributed control systems (DCSs) is even better, with an input filter which makes the SIL circuit immune to the test impulse which is typically used by a DCS. You will also benefit from simple maintenance: the fuses are accessible from the outside and can easily be changed. You can see the status of the safety and the monitoring devices clearly on the displays mounted directly to the device.

All devices are accredited though certification by the internationally recognised TÜV-NORD group – for secure process applications around the globe. Let's connect.



**Safe control of back-up systems**  
Equipped with wide range input voltages in the monitoring circuit from 24 V AC/DC to 230 V AC/DC, the relay is designed for individual use, e.g. in back-up systems or the overfill prevention devices of tank farms.



**Safe monitoring of furnace firing systems**  
The feed-in of fuel must be interrupted as soon as a boiler plant reaches any safety criterion limits. The SAFESERIES offers you a safety switch-off for the feed-in of fuel to furnace firing systems up to safety integrity level (SIL) 3.





**Safe use in corrosive environments**

The SIL3 relay is also available with a G3 coating, which makes it especially suitable for use in aggressive environmental conditions.



Check out our Weidmüller customer magazine WIN! for more information. No. 11 (pages 11-13)

**Signals under optimal protection**

The VARITECTOR SPC series of surge protection devices with SIL certification by TÜV Nord provides the best protection of signals in safety circuits for the process industry.

**Safe activation and deactivation**

This universal device can be used for either the energise-to-safe or de-energise-to-safe operation modes, as you wish. This makes it suitable, e.g. for pump controllers or extinguishing systems.





# You have strict requirements for the functional reliability of your systems

## We connect your safety-related applications reliably

Let's connect.

D



**Safe process and power technology is a top priority for you. For example, a reliable emergency shutdown, which initiates appropriate countermeasures in hazardous situations, is indispensable. These might extend to the automatic shutdown of the system or subsystems within it.**

As a specialist in industrial connectivity, we offer a comprehensive solution for safety-sensitive areas, from the control room through to the field.

The SAFESERIES SIL relay is ideally suited for use in safety-related applications. It is designed for low and high demand modes.

With the wide range input voltage in the protective circuit of 24 V UC to 230 V UC, for example, you can control back-up systems with high DC voltage. You get additional flexibility for your applications with the optional "G3" coating for use in harsh environments.

The safe and reliable coupling of measuring instruments, actuators and sub-assemblies to the safety-relevant signal circuit is handled by our VARITECTOR SPC, the lightning and surge protection for signal circuits. Certified for safety requirement level SIL 3 according to EN 61508, and accredited by TÜV NORD, it can easily be incorporated into your safety calculations.

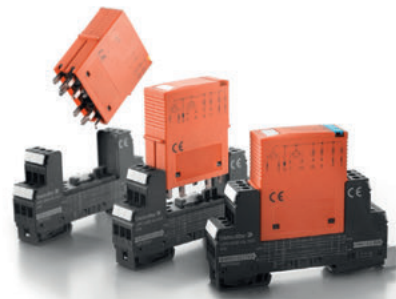
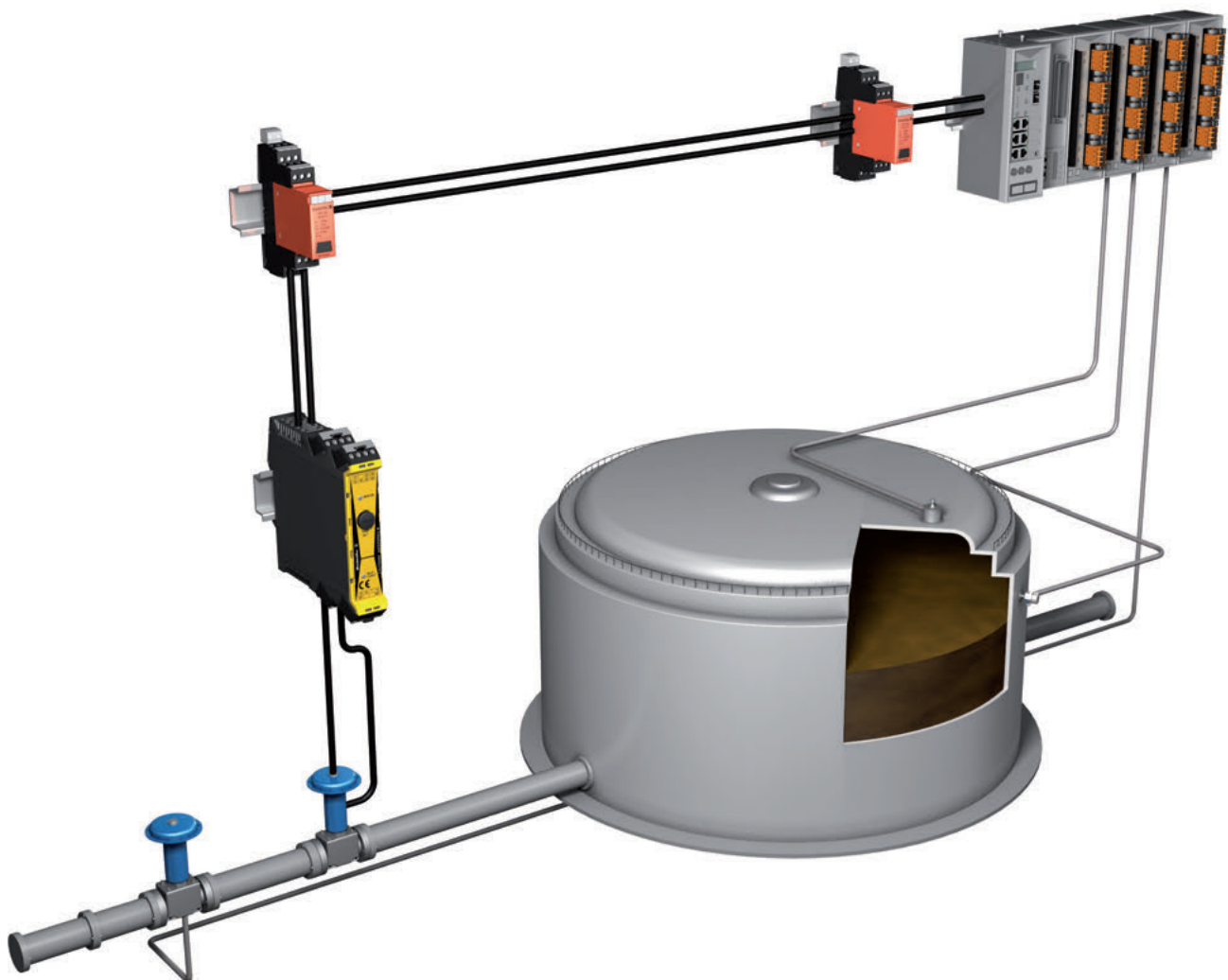

### SAFESERIES

- Certified to EN 61508 for SIL3
- Wide voltage input from 24 to 230 V AC/DC for the monitoring of field signals
- Variant with G3 protection for extreme conditions
- Other variants for burner management or on/off switching

### VARITECTOR SPC

- 2 analogue or 4 digital signals on a width of just 17.8 mm
- Monitoring with status indicator and message function
- Testable with V-TEST according to IEC62305
- Variants with SIL certification or EX approval



## SAFESERIES SIL relays

### SIL3 relays

- With and without monitoring circuit
- Wide-range input voltage in the monitoring circuit
- Externally accessible fuse
- TÜV certified „Safety Approved“

### SCS 24 V DC P1SIL3DS



The SCS 24VDC P1SIL3DS safety relay is used in areas that require a functionally safe shutdown. This component fulfils the requirements of EN 61508, SIL 3.

### Technical data

<b>Temperatures</b>	
Ambient temperature (operational)	-25...50 °C
Storage temperature	-40...85 °C
<b>General data</b>	
Noxious gas resistance to EN 60068-2-60	Yes (art. No.: 1304040000 only)
<b>Input (safety circuit)</b>	
Rated control voltage	24 V DC ± 20%
Guaranteed current consumption of 24 VDC -10%	35 mA
Power consumption	42 mA
Status indicator	LED yellow
<b>Input (monitor circuit)</b>	
Rated control voltage	24 V UC...230 V UC ± 10 %
Current consumption	23 mA @ 24 V DC, 4,4 mA @ 230 V AC
Status indicator	LED yellow
<b>Output (safety circuit)</b>	
Contact design	NO contact
max. switching current, internal fuse	5 A (refer to derating curve)
max. switching current, external fuse	5 A (refer to derating curve)
max. permitted switching voltage	250 V AC / 30 V DC
max. permitted switching current	8 A
min. switching power	12 V / 10 mA
max. switching power	2000 VA
Switch-on time	typ. 7 ms
Base material of the contact	AgNi 0.15 gold flashed
Internal fuse	5 A time-lag
External back-up fuse	No
Short-circuit-proof	No
<b>Output (monitor circuit)</b>	
Contact design	CO contact
max. permitted switching voltage	24 V DC
max. permitted switching current	30 mA
min. switching power	1 V / 1 mA
Base material of the contact	AgNi 5µm Au
Switch-on time	typ. 17 ms
Short-circuit-proof	No
<b>Insulation coordination (EN 50178)</b>	
Rated voltage	300 V
Creepage and clearance distance input - output	≥ 5,5 mm
Creepage and clearance distance output - output	≥ 5,5 mm
Dielectric strength input - output	1,2 kV <sub>eff</sub> / 1 min.
Dielectric strength output - output	1,2 kV <sub>eff</sub> / 1 min.
Dielectric strength to mounting rail	1,2 kV <sub>eff</sub> / 1 min.
Impulse withstand voltage	6 kV (1.2/50 µs)
Overvoltage category	III
Pollution degree	2
<b>Further details of approvals / standards</b>	
Standards	EN 50178, EN 61000, EN 61326-3-2
<b>Dimensions</b>	
Clamping range (nominal / min. / max.)	1.5 / 0.13 / 2.5
Depth x width x height	114 / 22.5 / 117.2
<b>Note</b>	

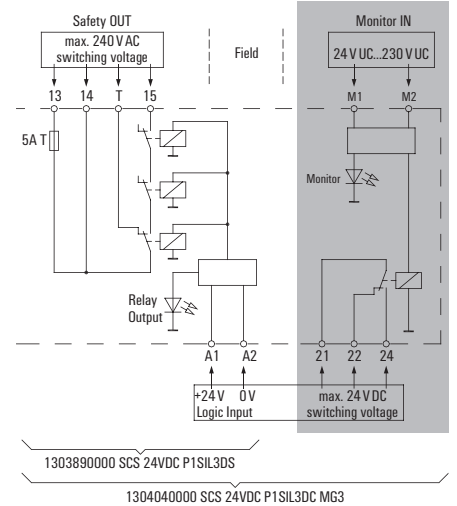

### Derating curve

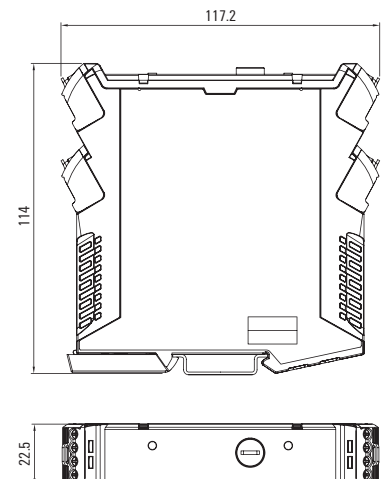
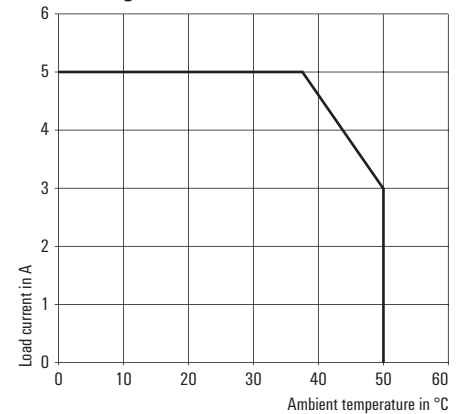

### Ordering data

	Type	Qty.	Order No.
with monitoring	SCS 24VDC P1SIL3DS M	1	1303760000
without monitoring	SCS 24VDC P1SIL3DS	1	1303890000
with monitoring and G3 gas-corrosion resistant	SCS 24VDC P1SIL3DS MG3	1	1304040000
<b>Note</b>			

SIL3 relays

- Energised / de-energised to safe
- All pins can be disconnected
- Test inputs for testing the relay contacts
- Externally accessible fuse
- TÜV certified „Safety Approved“

SCS 24 V DC P2SIL3DSES



The safety relay SCS 24VDC P2SIL3DSES is used in areas that require functionally safe deactivation or activation. The requirements according to EN 61508, SIL3 can be fulfilled with this module.

Technical data

Temperatures	
Ambient temperature (operational)	-25 °C...50 °C
Storage temperature	-40 °C...85 °C
Input (safety circuit)	
Rated control voltage	24 V DC -15 / +20%
Guaranteed current consumption of 24 VDC -10%	35 mA
Power consumption	45 mA
Status indicator	LED yellow
Test inputs	
Rated control voltage	24 V DC
Status indicator	LED red flashing: test input is triggered
Number of test inputs	2
Output (safety circuit)	
Contact design	1 x de-energised to safe (NO contact), 1 x energised to safe (NO contact)
max. switching current, internal fuse	5 A (refer to derating curve)
max. switching current, external fuse	5 A (refer to derating curve)
max. permitted switching voltage	250 V AC
max. permitted switching current	8 A
min. switching power	12 V / 10 mA
max. switching power	2000 VA
Switch-on time	< 5.5 ms (DTS), < 5 ms (ETS)
Base material of the contact	Ag Ni 0.15
Internal fuse	5 A time-lag
External back-up fuse	5 A time lag
Short-circuit-proof	No
Insulation coordination (EN 50178)	
Rated voltage	300 V
Creepage and clearance distance input - output	≥ 5.5 mm
Creepage and clearance distance output - output	≥ 5.5 mm
Dielectric strength input - output	1.2 kV <sub>eff</sub> / 1 min.
Dielectric strength output - output	1.2 kV <sub>eff</sub> / 1 min.
Dielectric strength to mounting rail	1.2 kV <sub>eff</sub> / 1 min.
Impulse withstand voltage	6 kV (1.2/50 µs)
Overtoltage category	III
Pollution degree	2
Further details of approvals / standards	
Standards	EN 50178, EN 61000, EN 61326-3-2

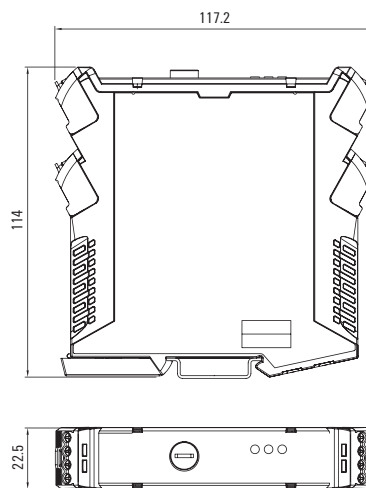
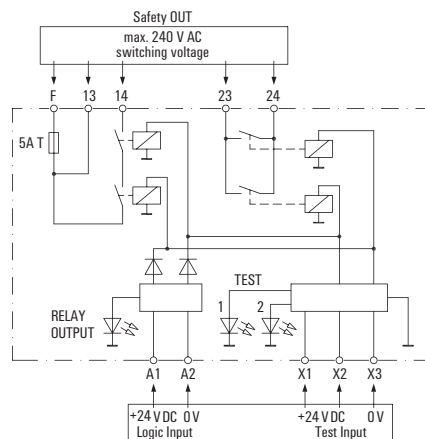

Dimensions	
Clamping range (nominal / min. / max.)	mm <sup>2</sup> 1.5 / 0.13 / 2.5
Depth x width x height	mm 114 / 22.5 / 117.2
Note	
	DTS (de-energised to safe) ETS (energised to safe)

Ordering data

Type	Qty.	Order No.
SCS 24VDC P2SIL3DSES	1	1319270000

Note	

## SAFESERIES SIL relays

## SIL3 relays

- Positively-driven contacts
- 2-channel design
- Insert according to EN 50156
- TÜV certified „Safety Approved“

## Technical data

<b>Temperatures</b>	
Ambient temperature (operational)	-25 °C...55 °C
Storage temperature	-40 °C...85 °C
<b>Start circuit</b>	
Operating voltage	22 V DC, from internal power supply
Function	falling edge (button via S33/S34), rising edge (permanent bridge via S33/S35)
<b>Input (supply)</b>	
Rated control voltage	24 V DC $\pm$ 15 %
Current consumption	55 mA (release circuit enabled), 6 mA (release circuit not enabled)
Guaranteed current consumption at 24 V DC -10%	35 mA
Response time	with bridge via C1/C2: typ. 50 ms, without bridge via C1/C2: typ. 20 ms
Status display	LED green, power, LED yellow, signal
Short-circuit detection	Yes, max 4 s up to switch-off (Polyfuse)
<b>Monitoring circuit</b>	
Operating voltage	22 V DC, from internal power supply
Input	2, each externally bridgeable
<b>Output (release circuit)</b>	
Contact version	2 NO positively-driven (EN 50205)
Switching voltage AC, max.	250.000000 V
max. permitted switching current	6 A
min. switching power	12 V / 10 mA
max. switching power	2000 VA
Switch-on time	55 ms (C1/C2 bridged, switched via A1/A2), 30 ms (opening/closing of monitoring circuit)
Switch-off time	20 ms (C1/C2 bridged, switched via A1/A2), 15 ms (opening/closing of monitoring circuit)
Contact base material	AgSnO
max. switching current, external fuse	5 A
external back-up fuse	5 A time lag
<b>Feedback output</b>	
Contact version	1 NC positively-driven (EN 50205 type B)
Switching voltage AC, max.	250 V
Max. switching current	1 A
<b>Insulation coordination (EN 50178)</b>	
Rated voltage	300 V
Creepage and clearance distance input - output	$\geq$ 5,5 mm
Creepage and clearance distance output - output	$\geq$ 5,5 mm
Dielectric strength input - output	1,2 kV <sub>eff</sub> / 1 min.
Dielectric strength output - output	1,2 kV <sub>eff</sub> / 1 min.
Dielectric strength to mounting rail	1,2 kV <sub>eff</sub> / 1 min.
Impulse withstand voltage	6 kV (1.2/50 $\mu$ s)
Overvoltage category	III
Pollution degree	2
<b>Further details of approvals / standards</b>	
Standards	EN 50178, EN 61000, EN 61326-3-2, EN ISO 13849-1 (PLe)
<b>Dimensions</b>	
Clamping range (nominal / min. / max.)	mm <sup>2</sup> 1,5 / 0,13 / 2,5
Depth x width x height	mm 114 / 22,5 / 117,2
<b>Note</b>	

## Ordering data

Type	Qty.	Order No.
SCS 24VDC P2SIL3ES	1	1319280000

## Note

## SCS 24 V DC P2SIL3ES



The feed-in of fuel must be interrupted as soon as a boiler plant reaches any safety criterion limits. The safety relay SCS 24VDC P2SIL3ES enables you to carry out a safety shutdown of the fuel supply, to safety level SIL 3.

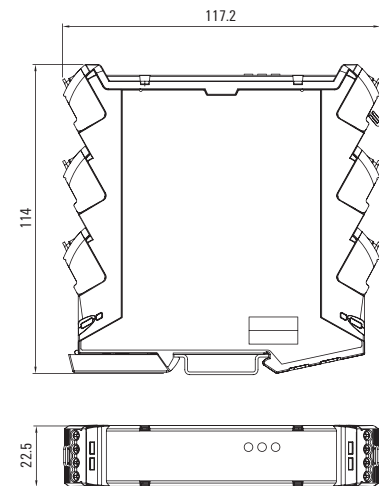
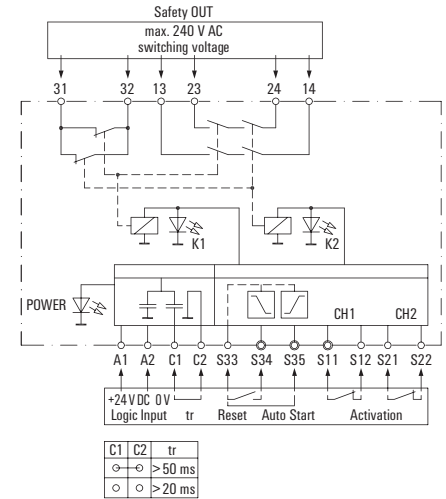

# Timer

---

<b>Timer</b>	BT-SERIES - Overview	E.2
	BT-SERIES - Timer	E.4
	MCZ-SERIES - Timer	E.8

---

# Installation timer

The electronic timer from the BT product range offers ideal solutions for industrial applications.

## The BT product range provides the following functions:

- Pick-up delay (BTR)
- Pulse emitter (BTTT)
- Multifunction with control input (BTM)
- Multifunction without control input (BTMF)
- Star-delta change-over

## E

## Time ranges and power supplies for timer

Using the central button, you can select the functions of the modules over either 4 or 8 time ranges.

The multi-voltage supply range offers a wide bandwidth for industrial use (see technical data).

## Connection of the timer

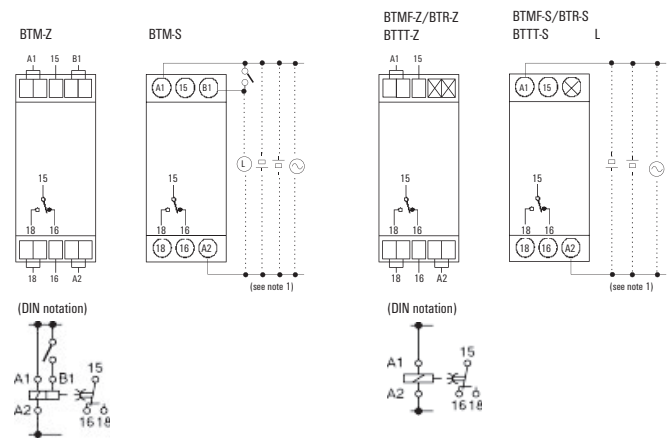

Note: 1. Pole numbers are not necessary for DC voltage supply.

2. The contact symbol of BTM is marked with  as it provides several operating modes and differs from the delayed contacts of conventional timer.



### Time ranges

Display of time scale	Time ranges
0.1 s	0.1 to 1.2 s
1 s	1 to 12 s
0.1 min	0.1 to 1.2 min
1 min	1 to 12 min
0.1 h	0.1 to 1.2 h
1 h	1 to 12 h
10 h	10 to 120 h

Note:

If the rotary button for time adjustment is set to "0", the output will be switched without delay.

### Choosing the time range

The time range is chosen by turning the rotary switch for the ON-time scale and OFF-time scale. The time scales are visible in the display to the left of the rotary switch in the following order: 0.1 s, 1 s, 0.1 m, 1 m, 0.1 h, 1 h.

Note:

The time scales "1 s" and "0.1 h" are given twice. Both adjustments represent the same time scale.

### Locking/unlocking of selectors and time setting dial

The rotary switches for the ON/OFF time adjustment and the option selector for the time scale can be locked with the locking key.

This pen-style special tool is available separately. To lock either rotary switches or the option selector, simply insert the locking key into the keyhole bottom right of the rotary switch/option selector and turn it clockwise until the button/switch is totally covered by the red cover. To unlock, simply turn the key in the opposite direction.

### Connection system

The units offers the following connection technologies:

Screw connection

- 2 x 1.5 mm<sup>2</sup> with wire end ferrule,
- 2 x 2.5 mm<sup>2</sup> without wire end ferrule

Tension clamp connection

- 2 x 1.5 mm<sup>2</sup> with wire end ferrule,
- 2 x 1.5 mm<sup>2</sup> without wire end ferrule

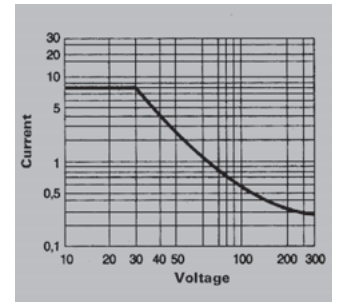
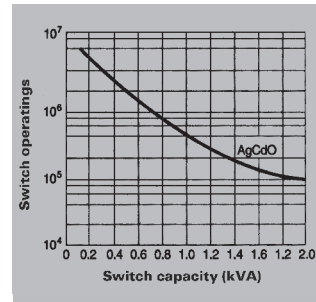

### Dimensions

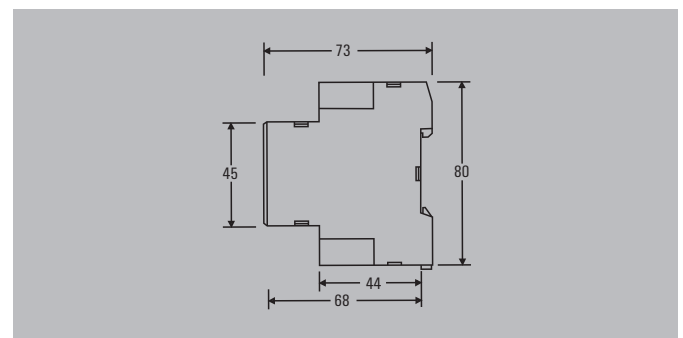

### Screw connection

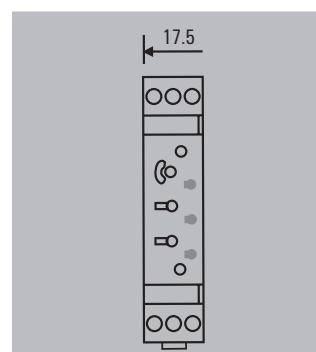

### Tension clamp connection

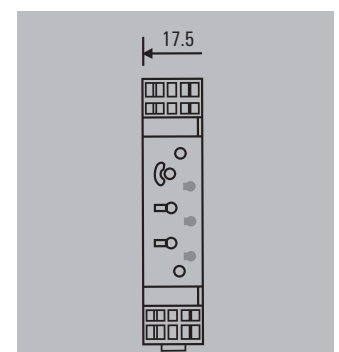

Installation timer

- Screw or tension clamp connection
- LED status indicator
- Approvals

Input:  
Output:

508  
EN 61812-1  
IEC 60947-5-1  
IEC 60664-1  
EN 55011

voltage present  
output active  
22.2 Nr. 14  
IEC 60664-1  
EN 61812-1  
IEC 60947-5-1  
EN 50082-2



Type designation:

- B** = Building
- T** = Timer
- R** = Response Delay
- TT** = Two Times
- M** = Multifunction, 8 ranges
- MF** = Multifunction, 4 ranges
- DS** = Delta, Star
- S** = Screw
- Z** = Tension

Input		Contacts hard gold plated	
Rated voltage		24 ... 230 V AC, 50/60 Hz, 24 ... 48 V DC	
Voltage tolerance		85 ... 110 % of rated voltage	
Breaking voltage		Max. 2.4 V AC/DC	
Power consumption per type	V AC	21...33 VA at 230 V	
	V DC	0.6...1.3 W at 24 V	
Reset time		Min. 0.1 s (BTDS: 0.5 s)	
Insulation			
Insulation resistance		100 MΩ min., at 500 V DC	
Insulation test voltage	between input and output, to enclosure	2000 V AC, 50/60 Hz, 1 min	
	between non-adjacent contacts	1000 V AC, 50/60 Hz, 1 min	
Ingress protection class		IP30, terminal block IP20	
Output			
Contact/contact material		1 change-over contact (BTDS 2 NOC) / AgNi 90/10	
Switch output		5 A at 250 V AC, resistive load (cos φ=1)	
Service life	mechanical min.	10 <sup>7</sup> switching cycles (no load, 1800/h)	
	electrical min.	10 <sup>6</sup> switching cycles (5A at 250 V AC, resistive load at 1800/h)	
Time range		0,10 s...120 h	
Repetition accuracy		± 1 %	
Other data			
Flammability class as per UL94		V-2	
Ambient temperature/storage temperature		-10...+55 °C / -25...+65 °C (without condensation)	
Humidity		35...85 % rel. humidity, no condensation	
Clamping range (nominal/min/max)	mm <sup>2</sup>		
Depth x Width x Height	mm	73.0 x 17.5 x 80.0	

Accessories

Designation
Locking and adjusting key

Type	Qty.	Order No.
BT Lock Pen	1	8659840000

Multifunction relay with control input (BTM)



Ordering data

Connection system	Type	Qty.	Order No.
Screw connection	BTM-S	1	8647700000
Tension clamp	BTM-Z	1	8647710000

Functions

Function A - on-delay

Connect power supply (A1/A2). When the input signal (B1/A2) is applied, the set time T begins to delay. After the time has expired, the output R (15/18) disconnects the load. To reset, the input signal needs to be switched off.



Function E - passing make function

Connect power supply (A1/A2). After applying the input signal (B1/A2), output R (15/18) connects the load immediately. At the end of the set delay time T, output R (15/18) switches the load off again.



Function B - pulse emitter (starting at normal position)

Connect power supply (A1/A2). After applying the input signal (B1/A2), output R (15/18) switches the load synchronously and alternately between the normal and operated positions within the set time T. In this function, the cycle starts at the normal position.

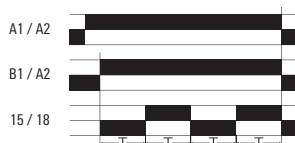

Function G - on and off-delay function

Connect power supply (A1/A2). Time delay T begins after applying the input signal (B1/A2). At the end of this time, output R (15/18) connects the load (on-delayed). After the input signal (B1/A2) has been switched off again, the output switches the load off again after the set time (off-delayed).

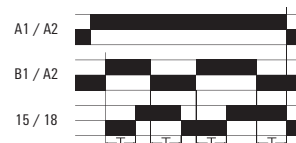

Function B2 - pulse emitter (starting at operated position)

Connect power supply (A1/A2). After applying the input signal (B1/A2), output R (15/18) switches the load synchronously and alternately between the normal and operated positions within the set time T. In this function, the cycle starts at the operated position.



Function J - on-delay with pulse

Connect power supply (A1/A2). Time delay T begins after applying the input signal (B1/A2). At the end of this time, the output R (15/18) connects the load for 1 second.

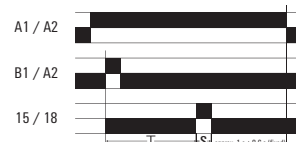

Function C - interval time-delay

Connect power supply (A1/A2). After applying the input signal (B1/A2), output R (15/18) connects the load for the set time T. Output R (15/18) switches the load off again at the end of time T. After switching off the input signal (B1/A2), output R (15/18) connects the load again for the set time T. Output R (15/18) switches the load off again at the end of time T.



Function D - off-delay function

Connect power supply (A1/A2). After applying the input signal (B1/A2), output R (15/18) connects the load. The time delay T begins after the input signal (B1/A2) has been switched off. At the end of time T, output R (15/18) switches the load off again.

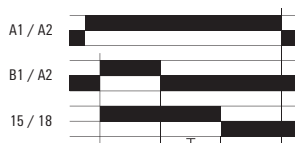



**Multi-function relay without control input (BTMF)**



**Ordering data**

Connection system	Type	Qty.	Order No.
Screw connection	BTMF-S	1	8647680000
Tension clamp	BTMF-Z	1	8647690000

**Functions**

**Function A – on-delay**

When the input signal (A1/A2) is applied, the on-delay lasting for the set time T starts. The output R (15/18) connects the load at the end of the set time. To reset, the power supply has to be switched off.



**Timer (BTR)**



**Ordering data**

Connection system	Type	Qty.	Order No.
Screw connection	BTR-S	1	8647720000
Tension clamp	BTR-Z	1	8647730000

**Functions**

**Function A – on-delay**

When the power supply is connected (A1/A2), the on-delay lasting for the set time T starts. The output R (15/18) connects the load at the end of the set time.



**Function B2 – pulse emitter (starting at operated condition)**

After applying the input signal (A1/A2), output R (15/18) switches the load synchronously and alternately between the normal and operated positions within the set time T. In this function, the cycle starts at the operated position.

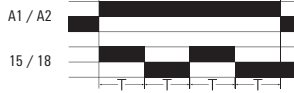

**Function E – passing make function**

After applying the input signal (A1/A2), output R (15/18) connects the load immediately. At the end of the set delay time T, output R (15/18) switches the load off again.



**Function J – on-delay with pulse**

Time delay T begins after applying the input signal (A1/A2). At the end of this time, the output R (15/18) connects the load for 1 second.

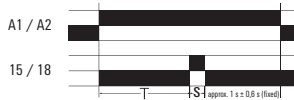

Timer (BTTT)



Ordering data

Connection system	Type	Qty.	Order No.
Screw connection	BTTT-S	1	8647740000

Functions

Function BTTT - pulse emitter

When the power supply is connected (A1/A2), the repeat cycle begins with two independently adjustable times. The standard setting is to start at the normal position. A bridge between connections A1 and A2 allows the module to start at the operated position.

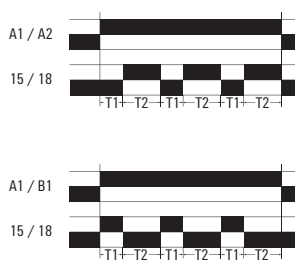

**Miniconditioner MCZ T0**

- Components for lengthening short pulses for the PLC
- Fixed switch-off delay
- Low input power
- Screw connection system
- Width 6 mm
- For mounting on TS 35

**24 V DC 50 ms**

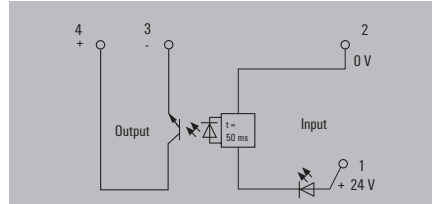
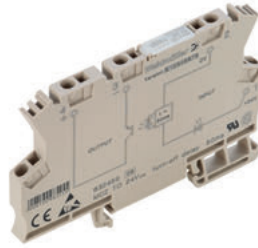

**24 V DC 150 ms**

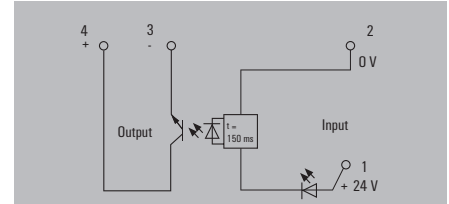
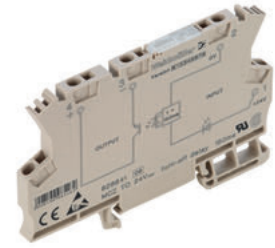

**Technical data**

<b>Input</b>	
Rated control voltage	24 V DC ±10 %
Rated current AC / DC	/ 6.7 mA ±10 %
Power rating	160 mW
Min. pulse duration	2 ms
Status indicator	Green LED
<b>Output</b>	
Max. switching voltage, DC	48 V
Continuous current	0.1 A
Switch-off delay	50 ms
Max. switching frequency at rated load	20 Hz
<b>Rated data</b>	
Ambient temperature (operational)	-25 °C...50 °C
Storage temperature	-40 °C...85 °C
Humidity	40 °C / 93 % rel. humidity, no condensation
Approvals	CE, CSA, cURus, EAC
<b>Insulation coordination (EN 50178)</b>	
Rated voltage	300 V
Overvoltage category	III
Dielectric strength for control side - load side	
Dielectric strength input - output	1.2 kV <sub>eff</sub> / 5 s
Dielectric strength to mounting rail	4 kV <sub>eff</sub> / 1 min.
Clearance and creepage distances for control side - load side	
Creepage and clearance distance input - output	≥ 5.5 mm
Impulse withstand voltage	6 kV (1.2/50 µs)
Pollution degree	2

<b>Input</b>	
Rated control voltage	24 V DC ±10 %
Rated current AC / DC	/ 6.7 mA ±10 %
Power rating	160 mW
Min. pulse duration	2.5 ms
Status indicator	Green LED
<b>Output</b>	
Max. switching voltage, DC	48 V
Continuous current	0.1 A
Switch-off delay	150 ms
Max. switching frequency at rated load	5 Hz
<b>Rated data</b>	
Ambient temperature (operational)	-25 °C...50 °C
Storage temperature	-40 °C...85 °C
Humidity	40 °C / 93 % rel. humidity, no condensation
Approvals	CE, CSA, cURus, EAC
<b>Insulation coordination (EN 50178)</b>	
Rated voltage	300 V
Overvoltage category	III
Dielectric strength for control side - load side	
Dielectric strength input - output	1.2 kV <sub>eff</sub> / 5 s
Dielectric strength to mounting rail	4 kV <sub>eff</sub> / 1 min.
Clearance and creepage distances for control side - load side	
Creepage and clearance distance input - output	≥ 5.5 mm
Impulse withstand voltage	6 kV (1.2/50 µs)
Pollution degree	2

<b>Input</b>	
Rated control voltage	24 V DC ±10 %
Rated current AC / DC	/ 6.7 mA ±10 %
Power rating	160 mW
Min. pulse duration	2.5 ms
Status indicator	Green LED
<b>Output</b>	
Max. switching voltage, DC	48 V
Continuous current	0.1 A
Switch-off delay	150 ms
Max. switching frequency at rated load	5 Hz
<b>Rated data</b>	
Ambient temperature (operational)	-25 °C...50 °C
Storage temperature	-40 °C...85 °C
Humidity	40 °C / 93 % rel. humidity, no condensation
Approvals	CE, CSA, cURus, EAC
<b>Insulation coordination (EN 50178)</b>	
Rated voltage	300 V
Overvoltage category	III
Dielectric strength for control side - load side	
Dielectric strength input - output	1.2 kV <sub>eff</sub> / 5 s
Dielectric strength to mounting rail	4 kV <sub>eff</sub> / 1 min.
Clearance and creepage distances for control side - load side	
Creepage and clearance distance input - output	≥ 5.5 mm
Impulse withstand voltage	6 kV (1.2/50 µs)
Pollution degree	2

<b>Dimensions</b>	
Clamping range (nominal / min. / max.)	mm <sup>2</sup> 1.5 / 0.5 / 2.5
Depth x width x height	mm 63.2 / 6 / 91
<b>Note</b>	
For mounting on TS 35 rail	

<b>Dimensions</b>	
Clamping range (nominal / min. / max.)	mm <sup>2</sup> 1.5 / 0.5 / 2.5
Depth x width x height	mm 63.2 / 6 / 91
<b>Note</b>	
For mounting on TS 35 rail	

<b>Dimensions</b>	
Clamping range (nominal / min. / max.)	mm <sup>2</sup> 1.5 / 0.5 / 2.5
Depth x width x height	mm 63.2 / 6 / 91
<b>Note</b>	
For mounting on TS 35 rail	

**Ordering data**

Tension-clamp connection
--------------------------

Type	Qty.	Order No.
MCZ T0 24VDC/50MS	10	8324590000

Type	Qty.	Order No.
MCZ T0 24VDC/150MS	10	8286410000

<b>Note</b>
-------------

<b>Note</b>
-------------

<b>Note</b>
-------------

**Accessories**

<b>Note</b>
-------------

AP MCZ end plate 8389030000
-----------------------------

AP MCZ end plate 8389030000
-----------------------------

# Technical appendix/Glossary

<b>Technical appendix/Glossary</b>	Relay modules and solid-state relays - Comparison	W.2
	Technical appendix: Relay modules	W.4
	Glossary: Relay modules	W.8
	Technical appendix: Solid-state relays	W.28
	Glossary: Solid-state relays	W.36

# Relay modules and solid-state relays – Comparison

## Advantages of electromechanical relay modules (EMR)

- + AC and DC operation in load circuit possible  
Versatile (advantage as interface between different plant equipment)
- + No leakage current in the load circuit  
A semi-conductor does not achieve 100 % isolation
- + Low residual voltage in the load circuit  
Low voltage drop
- + No power loss in the load circuit  
In contrast to the semi-conductor in opto modules there is no electrical resistance in the contacts of the electromechanical relay modules that can lead to a rise in temperature when under load. Therefore, heat sinks are not necessary.
- + Multiple contacts possible  
A single control signal can switch several load circuits.
- + Control circuit less sensitive to *transients*\*)  
Unwanted switching operations caused by voltage fluctuations are prevented by the make capacity of the magnetic coil.

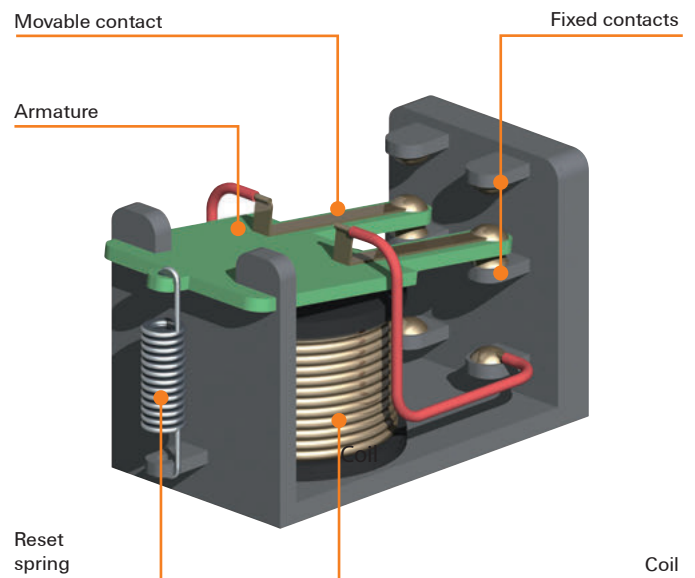

\*) Refer to page W.8 in the Glossary for a detailed explanation of this term.

Depending on the requirements, the choice between electromechanical and solid-state relays is made based on the different advantages that the different versions offer:

### Advantages of solid-state relays (SSR)

- + Long operational lifetime and reliability  
No moving parts or contact wear
- + Small dimensions  
Saves space on the PCB and mounting rail
- + Low control power  
An LED is activated - no mechanical parts are moved
- + Fast response times  
Fast switching, which allows high frequencies to be achieved
- + No contact bounce  
Reduces switching delays
- + No switching noise  
Suitable for use in noise-sensitive environments
- + Not susceptible to shock and vibration  
Prevents unwanted switching statuses
- + No electromagnetic radiation due to switching sparks or coils  
No interference of adjacent assemblies or electronics components

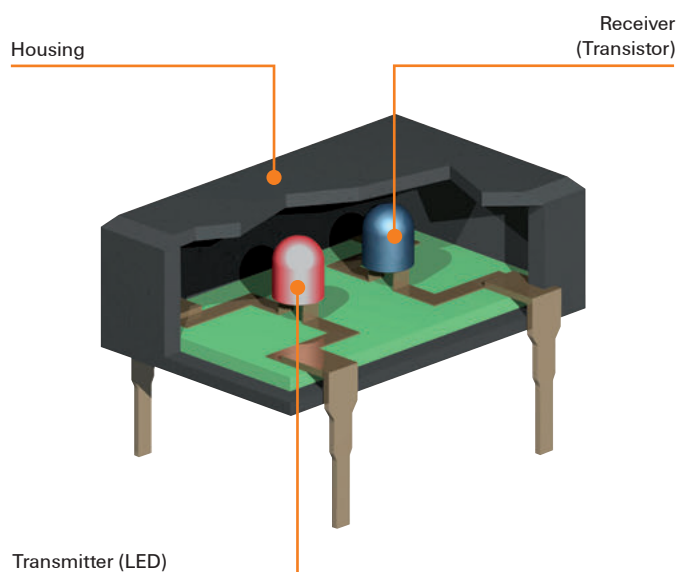

# Relay modules – an overview

## Historical background

The term 'relay' was originally used for a station where stagecoaches were able to change their tired horses for fresh ones. The term 'relay' was given a totally different meaning by the English physicist Charles Wheatstone (1802–1875). In Wheatstone's times, departing trains were advised of by a bell ringing at the next railway station up the line.

This was achieved by connecting a battery in the first station to a bell in the second. However, as the railway stations were generally several kilometres apart the power arriving at the second station was often insufficient to ring the bell. Wheatstone invented a switchgear apparatus that was installed at the second railway station. This continued to function even with low power supply levels. The switchgear apparatus switched a second electrical circuit that actuated the bell. This was the birth of the electromagnetic relay.

## How a relay functions

A relay is an electromagnetic switch comprising of two galvanically isolated circuits. Firstly the control circuit and secondly the open circuit with the normally open contact. As soon as the control circuit is energised, the coil creates a magnetic field in the core/yoke and attracts the armature. The actuator now actuates the switch at the output, the normally open contact (make contact) closes and the normally closed contact (break contact) opens. When the control circuit is turned off, the magnetic field diminishes and the return spring returns the armature to its initial position. The actuator moves the normally open (make contact) back to its normal position, the normally open contact opens, the normally closed contact (break contact) closes.

Consequently, with low power input – battery power for example – a relay provides the option of switching heavy loads as well as being able to serve as a switching amplifier. Thanks to the isolation between the input and output, relays are also suitable for providing separation when the power of the control and the open circuits differ. Equipped with several NO (make) contacts, a relay can also be utilised for multiplying signals.

## From relay to relay module

There are two alternative methods that make a relay module suitable for use in industrial applications: mounting onto a PCB – in combination with the corresponding assembly techniques and circuitry – or plugging onto a specially designed relay base.

Generally, the design and rating data determine if a relay coupler is or is not suitable for a particular application.

For example, relay modules with plugged on relays are only partly suitable for use in applications subjected to heavy vibrations. In this case, relay modules with soldered relays should be preferred. Low, compact designs such as those provided by the RIDERSERIES are utilised in small consumer units where the overall available height is limited. Conversely, the compact design of the TERMSERIES helps to save space in electrical cabinets.

## Protective separation

It is essential that all electrical equipment required to provide protective separation be designed in such a manner that the insulation cannot be impaired, for example by mechanical errors. If a mechanical error occurs in a relay (bent soldering pin, broken winding wire or broken spring), 'protective separation' must be guaranteed. Relays are specified and tested in accordance with EN 61810-1. However, the standard makes no reference to EN 50178 (Electronic equipment for use in power installations); equally no definition is given for the term 'protective separation'. Things are made worse by the fact that different measurement conditions are given for the test voltages stipulated for relays. As a consequence, the test voltages cannot be applied to the standards EN 50178 or EN 61140. And because the user is nevertheless increasingly deploying electrical equipment that is supposed to guarantee 'protective separation', a large number of manufacturers of relays point to the EN 61140 and carry out the tests accordingly. And of course the values are then 'protective separation' conform.

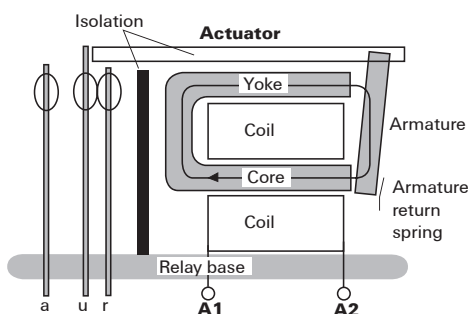

## Standards

The following individual standards are applied in accordance with the corresponding requirements:

### Relay modules

- DIN EN 50178:  
Electronic equipment for use in power installations

### Relays

- DIN EN 61810-1:  
Electromechanical elementary relays (electromechanical elementary relays without specified time response characteristics)  
Part 1: General and safety requirements

### Relay base

- DIN EN 61984  
Connectors - Safety requirements and tests

## EMC – Electromagnetic compatibility

DIN EN 61000-6-1

Part 6-1: Generic standards; Immunity for residential, commercial and light-industrial environments

DIN EN 61000-6-2

Part 6-2: Generic standards - Immunity for industrial environments

DIN EN 61000-6-3

Part 6-3: Generic standards - Emission standard for residential, commercial and light-industrial environments

DIN EN 61000-6-4

Part 6-4: Generic standards - Emission standard for industrial environments

## Coil suppression circuit

In DC circuits, the inductance of the relay coil generates a release voltage when de-energised that is capable of damaging or destroying the connected control electronics. A free wheel diode connected in parallel to the coil limits the release voltage, protects the control electronics and prevents induction of the cut-off voltage to other signal lines.

Large circuits or long cable runs are subjected to increased electrical and electromechanical interference and damage. Malfunctions or even total failure of the relay module can result. The radiated interference, and not to forget leakage currents emanating from trigger modules, can also mean that a triggered relay does not drop out. As standards specify that the drop-out voltage is limited to about 15 percent of the rated voltage, the interference voltage generated can be sufficient to prevent the relay from opening. One way of resolving this problem is to connect an RC combination line side to filter out disturbances and provide capacitive suppression of interference voltages.

TERMSERIES products are supplied ex works with these protective circuits already integrated in the electronics; for the RIDERSERIES these are available as modular series electronics.

The same principles apply as with contact protection circuits.



# Relay modules – an overview

## Switching large and small capacities

Basically, the reliability of the contacts in a relay reaches a maximum at a medium current load thanks to the continuous self-cleaning effect. As the contact load increases and hence leads to more severe erosion of the contacts, the switching reliability decreases with an increasing number of switching operations. This reduces the service life of the contacts. Although at very low loads the minimal erosion of the contacts does raise the service life more or less to the level of the mechanical service life, the lack of a self-cleaning effect contributes to a lower contact reliability.

Reliable contact at low currents, especially when only small voltages are involved as well, depends on the choice of contact material. Contacts of silver-nickel, which is standard for the majority of Weidmüller relays, are generally suitable for currents of approx. 10 mA and higher. Such large-surface contacts can switch both low and high currents. However, at low currents occasional failures can occur due to erosion and the lack of the self-cleaning effect. The higher the current, the more reliable is the contact – thanks to the self-cleaning. Silver-nickel is suitable as a contact material for low currents/voltages. It provides, however, only **moderate switching reliability**. If this is acceptable, then conventional standard relays represent an inexpensive solution.

For applications that call for **improved contact reliability** or low currents/voltages, conventional relays with hard-plated gold contacts are preferable because they do not erode and therefore operate more reliably.

If **maximum switching reliability** is necessary, especially for low currents/voltages, a relay should not be your first choice. In these instances Weidmüller advises the use of solid-state relays. Wear and abrasion caused by mechanical movements are non-existent in solid-state relays.

## Protective circuits for the contacts

The switching of inductive or capacitive loads produces switching sparks which can influence the electrical service life of the relays. The following protective circuits for the contacts reduce contact wear:

### Diode

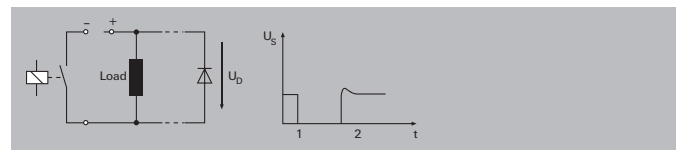

### Free-wheeling diodes (DC)

Free-wheeling diodes are used primarily to protect against overvoltages, which occur through self-induction when switching off inductive DC loads (electric motors, relay coils). Voltage spikes are limited to the equivalent value of the diode forward voltage and excess voltage is discharged via the diode. However, this leads to a delay in the voltage drop and as such also delays the switching operation.

Advantage: Can be used for all capacities, low surge, minimum space required, low price

Disadvantage: Very long release delay

### Diode and Z-diode

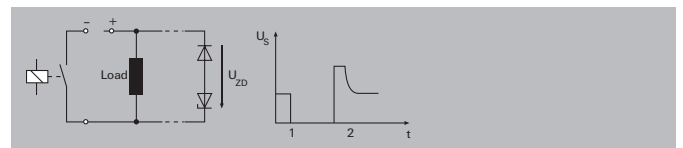

### Zener diode / suppressor diode (DC)

These function as normal diodes in the forward conducting direction. In the blocking direction they become low resistant at a certain voltage (breakdown voltage).

High levels of overvoltages can lead to the destruction of the zener diode / suppressor diode.

Advantage: Low surge (defined by Z-diode), short release delay

Disadvantage: Cannot be used for large capacities

### Varistor

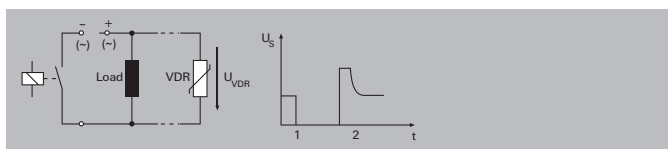

#### Varistor (AC/DC)

The functional principle of the varistor is also based on a breakdown voltage, but with faster reaction times. This allows higher levels of energy to be shunted, however, these lead to the component aging. This in turn reduces the breakdown voltage over time and increases the leakage current.

- Advantage: Low surge, short release delay
- Disadvantage: High current load on the contacts when switching on; more complicated and expensive at greater capacities

#### RC combination

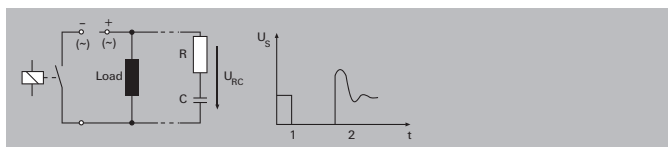

#### RC-element (AC)

The RC element compensates voltage spikes by means of a capacitor. Due to the charging and discharging characteristics interference pulses are filtered out when the voltage is rising and not first when overload is reached. For this reason, RC elements are used to protect against interference pulses and exclude faulty switching operations.

- Advantage: Short release delay, low price
- Disadvantage: Cannot be used for all operating voltages and capacities

$U_s$  = Voltage progression    1 = Closing    2 = Opening



# Glossary: Relay modules

## A

<b>AC</b>	Refers both to alternating values (such as voltage or current) as well as to those devices and variables which reference these devices. Specifications are valid for 50 Hz, unless otherwise indicated.
<b>AC coil, alternating current coil</b>	Relay; excitation with alternating current (AC). Specifications are valid for 50 Hz, unless otherwise indicated.
<b>Adhesion (contacts)</b>	This refers to when the relay armature does not return back to its starting position after the coil voltage has been turned off. The armature can get stuck if there is too much retentivity in the iron core or if the reset force is too small.
<b>Approvals and testing marks</b>	<p>Testing approvals are independent confirmation from governmental or private registration services and testing facilities. They certify that the product complies with the relevant regulations and maintains the specified product characteristics. Note: The ordering scheme gives you the choice of many variations, but not all variations are established as standard types (order numbers). Therefore, they may not be included in the list of approved relays. Technical specifications and list of approved types are available on request.</p> <p>CSA Canadian Standards Association, Canada          GL Germanischer Lloyd, Germany          TÜV Technical Monitoring Association, Germany          UL Underwriters Laboratories, Inc., USA;          UR Component Recognition Mark for the United States          cUR UL Component Recognition Mark for Canada          cURus UL Component Recognition Mark for the United States and Canada          cULus UL Component Listing Mark for the United States and Canada          VDE VDE testing location, Germany (advisory reports with production monitoring)</p>

## B

<b>B10</b>	The number of switching cycles for a load where 10 % of the relays fail. This value is used to determine the probability of system failure.
<b>Bounce (chatter)</b>	An unintended phenomenon that may arise during the closing or opening of a contact circuit when the contact elements touch and separate again before they have reached their final positions.
<b>Bounce times</b>	The time (average value) between the first and last closing (or first and last opening) of a relay contact. These times are valid when the rated voltage is used for excitation, without other components in series or in parallel to the coil, and at the reference temperature.
<b>Breaking capacity</b>	Maximum switching current that a relay contact can switch off under specified conditions, whereby the switching current must not be greater than the nominal current.
<b>Burn-off</b>	Loss of contact material due to switching electrical arcs.

## W

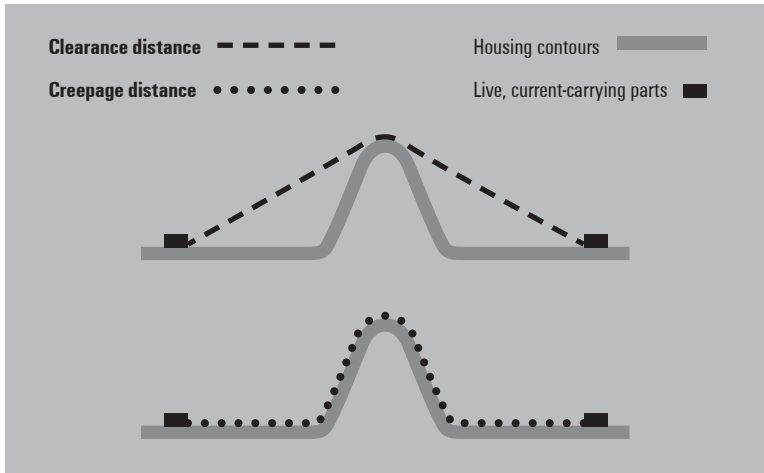
<b>C</b>	
<b>CE</b>	<p>Abbreviation for Communauté Européenne (the European Community). Manufacturers use the CE label to confirm that their products comply with the corresponding EC directives and the "essential requirements" therein. The EMC Directive 2004/108/EC and Low Voltage Directive 2006/95/EC are currently binding.</p>
<b>Clearance and creepage distances</b>	<p>Clearance and creepage distances are critical factors that affect the insulating capacity of electrical components. The creepage distance denotes the minimum clearance that two live parts along a surface must have in order to prohibit a flow of current across the insulating material at the specified operating voltage. The operating voltage, the choice of insulation material (material group) and the protective measures taken against contamination (pollution degree) all influence the creepage distance. The clearance distance denotes the minimum direct clearance (through the air) that two live parts must have to one another in order to prohibit a charge passing through the air (an arc). The expected surge voltage (rated impulse voltage) forms the basis for calculating the distances. The surge protection category and pollution severity are further factors that influence dimensional design considerations.</p>  <p><b>Clearance distance</b> - - - - -      Housing contours ————  <b>Creepage distance</b> •••••      Live, current-carrying parts ■■■</p>
<b>Coil resistance</b>	<p>DC resistance of a relay coil at the reference temperature (+20 °C); Higher coil temperatures increase the resistance value by 0.4 % / K. For actual operations, the excitation voltage should be adjusted accordingly (&gt; sparkover value). For AC coils, the inductive resistance is much greater than the DC value. This is why the current consumption of the coil is also specified at nominal excitation.</p>
<b>Coil specifications</b>	<p>The coil specifications are specified according to IEC 61810-1. Unless otherwise specified, these values apply under the following conditions: ambient temperature 23 °C; coil at ambient temperature (cold coil, without pre-excitation); 50 Hz for AC voltage excitation; operating range of class 2; densely assembled (mounting gap of 0 mm). A relative duty cycle of 100 % (continuous excitation) is permitted.</p>

**Combination of relay and plug-in socket, Insulation requirements**

The combination of relay and plug-in socket is described in the new relay standard IEC 61810-1. The relay sockets must meet the requirements of IEC 61984 and the insulation requirements of IEC 60664-1. Even if the socket itself already meets (or surpasses) the insulation requirements, there may still be reduced clearance and creepage distances (and thus reduced insulation rated voltage) for the combination of the relay and plug-in socket. Restrictions – such as a reduced voltage range or reduced pollution degree – should be expected for the relay/socket combination. This should be taken into consideration for miniature multi-pole relays with plug-in sockets which have minimal gaps between the contact circuits.

In addition to the insulation properties, the thermal properties of the combined relay/socket are very important (refer to the derating curves). The plug-in frames from different manufacturers cannot be compared directly, which is why the technical specifications are only guaranteed for approved relay/socket combinations. Possible risks of fire or reduced dielectric strength may result when non-approved combinations are in use.

**Contact material**

The list below provides an overview of the most important performance coatings and contact materials. The load capacity of the contacts and their life span can vary depending on the contact material and construction used. It is important to achieve the best combination of relay function and contact material. The specifications for individual relay types are only partially valid for other variants.

## 1) Performance coatings:

Pure gold – the best corrosion resistance but too soft when used as solid metal; high tendency toward cold welding in layer thickness > 1 µm (gold-flashed); only functions as a gold gilding and does not protect against corrosive gases.

## 2) Contact material:

**Hard gold (hard gold-plated)** - Very good corrosion resistance for dry loads; measuring and switching circuits; control inputs (1 mV – 10 V, 0.1 mA – 100 mA); low and constant contact resistance with the smallest switching power; low cold-welding tendency and low current/voltage switching; recommended operating range > 1 V, 1 mA, 50 mW. After switching higher loads (>10 V, 100 mA), small loads can no longer be switched.

**Silver Nickel AgNi90/10** - High resistance to burn-off; minimal tendency towards cold welding; higher contact resistance than AgNi0,15; circuits with medium to high loads; DC and AC circuits (solenoid valves, fans, heaters); not suitable for high capacitive in-rush currents; range of use > 12 V, 10 mA.

**Fine-grain silver AgNi0,15** - Relatively low contact resistance; low resistance to corrosive gases; all-purpose use for average loads and low loads; preferably in DC circuits (solenoid valves, fans, heaters); not suitable for high currents; range of use > 12 V, 10 mA.

**Silver-tin-oxide AgSnO2** - Minimal tendency to weld; high resistance to burn-off at high switching capacity; low material migration; circuits with high input and output loads; DC and AC circuits (lamp loads, capacitive loads, fluorescent tubes, switching power supplies, etc.). Well suited for resistive, inductive and capacitive DC applications due to low occurrence of material migration, range of use > 12 V, 100 mA..

**Silver-cadmium oxide AgCdO** – minimal tendency to weld; high resistance to burn-off; especially suitable for switching inductive loads; AC circuits, range of use > 12 V, 100 mA.

**Tungsten W** – highest melting point; for high switching frequency at minimal duty cycle; as a lead contact in circuits with high in-rush and switch-off loads.

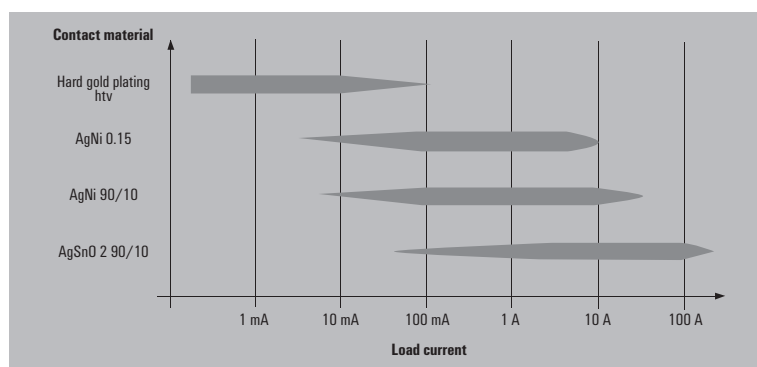

<b>Continuous current limit</b>	The highest current value (RMS value for AC) which a closed contact can continuously conduct at specified temperature limits; this corresponds to the thermal continuous current limit $I_{th}$ . Unless otherwise specified, the data refers to the following conditions: equal load on all contact circuits, input voltage is 110 % of rated coil voltage, maximum ambient temperature, opened vent, dense mounting (mounting clearances of 0 mm), and test conditions according to the positioning for the heating test in IEC EC 6 18 10-1 Appendix B.
<b>Continuous current</b>	The current that can be continuously conducted without exceeding the contact-overheating values under defined conditions.
<b>Continuous operation</b>	Operating mode in which a relay remains energised until it reaches thermal equilibrium.

## D

<b>DC</b>	Refers to the electrical variables such as voltage or current (DC, DC voltage) that are not dependent on time.
<b>DC switch-off capacity, Direct-current switch-off capacity</b>	Values below the DC switch-off capacity curve (for max. permitted switching voltage/current at resistive load) can be switched on and off reliably; e.g. an arc is extinguished (max. arc duration is 10 ms at resistive load). The position and shape of the load-limit curve is influenced by the contact material and relay construction (contact gap, opening speed of the contacts, etc.). Information about the electrical lifespan should not be derived from these curves!

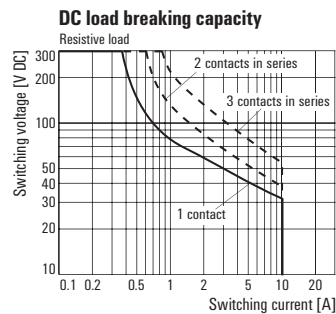

<p><b>Derating / derating curve</b></p>	<p>The continuous current is reduced at higher ambient temperatures; this is shown using a derating curve (a load reduction curve). Current flow generates heat, which increases as the current increases. Electrical components have an upper temperature limit which limits their ability to function.</p> <p>The temperature influencing the components is a combination of the ambient temperature and the heat generated by the current. So to ensure that the limit temperature is not exceeded, the current must be reduced when the overall temperature rises. The derating curve depicts the relationship between the prevailing temperature and the resulting maximum amperage with regards to the temperature limit.</p> <div data-bbox="592 786 1358 1122" style="border: 1px solid black; padding: 5px;"> <p><b>Derating curve</b></p> </div>
<p><b>Dielectric strength, test voltage</b></p>	<p>Voltage (RMS value for AC voltage, 50 Hz, 1 min) which can be applied between mutually insulated relay components during the voltage test.</p>
<p><b>Dimensions</b></p>	<p>Dimensions in millimetres.</p> <div data-bbox="592 1279 1034 1603" style="border: 1px solid black; padding: 5px;"> </div>
<p><b>DIN rail</b></p>	<p>Unless otherwise noted, Weidmüller's products are built and tested for mounting on DIN rail (rails according to TH35-7.5 / EN60175). Other installations (e.g. TH35-15) may function but have not been tested or approved.</p>
<p><b>Duty cycle, relative duty cycle</b></p>	<p>Describes the ratio of the excitation duration of a relay (duty cycle) to the entire cycle time in intermittent, continuous or short-time operations. The duty cycle is expressed as a percentage of the total cycle duration.</p>





**E**

**Earth and ground loops**

Denotes the connection of two potentials via their earth or ground connection. A potential difference between the earth or ground connection of two devices (for example, a sensor and controller) that are directly wired to one another causes current flow via the earth of the shared housing. These interference currents can lead to different problems, for example in the acquisition of measurement signals or when controlling actuators. When transmitting switching or measurement signals using a device with electrical isolation between the control and load circuits, it is important that a closed circuit via the earth or ground connection can never occur – so that no interference currents are generated.

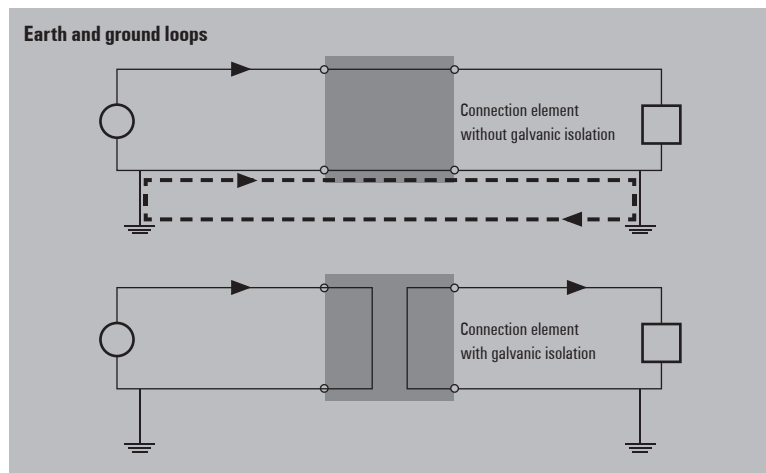

**Electrical lifespan curve**

The curve for the electrical lifespan specifies the typical lifespan as the mean cycles to failure (MCTF) and is based on the Weibull distribution. No guaranteed minimum values can be interpreted from this statistical data.

Note: The curve for the electrical lifespan applies only to the specified contact materials (or those in the datasheet). The lifespans for other contact materials cannot be derived from this curve. It is also not possible to derive information about the electrical lifespan by extrapolating the curve.

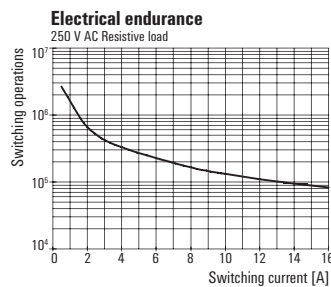

**W**

<p><b>Electrical lifespan, lifespan of contact</b></p>	<p>Number of switching cycles for a relay with electrical contact load under full operational capacity (according to IEC 61810-1 and IEC 61810-2). Unless indicated otherwise, the contact data and electrical lifespan are valid under the following conditions:</p> <ul style="list-style-type: none"> <li>• On NO contact,</li> <li>• AC mains frequency of 50 Hz,</li> <li>• 50 % relative duty cycle,</li> <li>• Nominal switching frequency,</li> <li>• Contact load, schedule A,</li> <li>• Resistive load,</li> <li>• Rated voltage (coil),</li> <li>• Ambient temperature 23 °C,</li> <li>• Protection degree RTII - flux-proof</li> <li>• Individual assembly</li> <li>• Vertically installed (the connections of a PCB relay point downwards).</li> </ul> <p>The electrical lifespan is specified according to the criteria for “useful life”, severity level B according to IEC 61810-2. The data does not cover all usage beyond the specified electrical lifespan. The user is obliged to avoid such situations. Experience shows that the electrical lifespan remains relatively constant up to a 0.8 power factor. When working with loads that have a power factor less than 0.8, we recommend consulting with the user.</p>
<p><b>Error, relay failure</b></p>	<p>According to IEC 61810, a relay failure is defined as the occurrence of malfunctions that exceed a certain number:</p> <ul style="list-style-type: none"> <li>• Malfunction On contact closing</li> <li>• Malfunction on contact opening (contact bridging for CO contact, as special type of malfunction during contact opening) or as</li> <li>• Insufficient dielectric strength.</li> </ul> <p>Such malfunctions must be considered in the scope of the application – they should not create any risks. Depending on the specific loads and the contact power, a malfunction can cause excessive heat or even a fire. The user is responsible for taking the necessary precautions in accordance with the relevant regulations.</p>
<p><b>F</b></p>	
<p><b>Flammability according to UL</b></p>	<p>Indicates the flammability class according to the specification from UL 94 (Underwriters Laboratories, Inc., USA). Flammability tests according to UL 94: for testing plastic materials and classifying the propagation/extinction characteristics when the material burns. The UL 94 flammability classes which are relevant to relays are V-0, V-1, V-2 and HB.</p>

**G**

<b>Galvanic isolation</b>	Potential-free isolation between electrical components. Electrical (or galvanic) isolation means that no charge can flow from one circuit to another. There is no conductive electrical connection between the circuits. The circuits can nevertheless exchange electrical power or signals via magnetic fields, infrared radiation or by charge displacements.
---------------------------	---

**H**

<b>Humidity / condensation</b>	Standard conditions: annual average relative humidity > 75 % at an ambient temperature of 21 °C, in 30 days, evenly distributed throughout the year, and 95 % at ambient temperature w of 25 °C. On other days: occasionally 85 % at 23 °C. No icing or condensation is allowed - affects storage and/or operation. When storing or operating under other conditions, you must take steps to avoid temperature changes which could cause icing or condensation. Operating and storage should be within the limits specified in the graphic.
--------------------------------	---

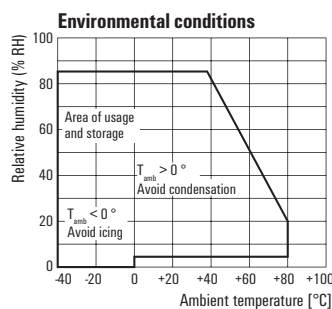
**I**

<b>Impulse withstand voltage</b>	The highest withstand voltage of a specified shape and polarity that does not lead to an insulation breakthrough or flash-over, under the specific conditions.
<b>Inductive loads</b>	Refer to usage categories.
<b>Inrush current</b>	Specified as the switching current by resistive loads that can turn on a relay under defined conditions. The data refers to the NO contact, nominal voltage, and a current value for a duration of max. 20 ms for at least 100 switching cycles, or 4 seconds with a relative duty cycle of 10 %, unless otherwise indicated.

**W**

<b>Insulating material group</b>	<p>According to their CTI (comparative tracking index) values, the insulating materials are categorised in one of the following four groups:</p> <p>Group I 600 CTI  Group II 400 CTI &lt; 600  Group IIIa 175 CTI &lt; 400  Group IIIb 100 CTI &lt; 175</p> <p>The figures for the comparative tracking index, according to IEC 60112 (DIN IEC 60112 / DIN VDE 0303-1) are determined using special samples prepared for this purpose with test solution A.</p>
<b>Insulation according to EN 50178</b>	<p>Specifications for insulation coordination with:</p> <ul style="list-style-type: none"> <li>• Type of insulation</li> <li>• Nominal voltage of the supply system</li> <li>• Pollution severity level</li> <li>• Impulse withstand voltage</li> <li>• Surge voltage category</li> </ul>

## M

<b>Max. switching current</b>	The max. switching current indicates the maximum level of current that can be switched.
<b>Max. switching frequency at rated load</b>	The number of switching operations that occur in a specific unit of time. The maximum switching frequency for average loads may be higher than the value specified for the nominal load when the switching characteristics of the load (such as arcing) do not cause the contact temperature to increase. The maximum switching frequency for no-load switching can also be used for loads where no arcing will take place (purely resistive loads cause no significant arcs up to 12 V or 50 mA at 12 – 250 V, because the arc breaks off fairly quickly through the contact opening (insulation)).
<b>Max. switching power</b>	The switching capacity is calculated as the product of the switching voltage and the switching power (in VA for AC; in W for DC).
<b>Mechanical service life</b>	Number of switching cycles for de-energised relay contacts, where a relay must remain functional within specific conditions.
<b>Micro-switch-off</b>	<p>Reasonable contact opening in at least one contact that ensures functional safety.</p> <p>Note: The contact opening has a requirement for the dielectric strength but not for the dimensions.</p>
<b>Minimum switching capacity</b>	Calculated product of switching current and switching voltage – a measure of reliable switching. Low contact resistance values are realised only above a certain load. Greatly increased resistances may occur at lower switching loads which can prevent the load circuit from being safely switched. The minimum contact loads for different contact materials should also be taken into account.
<b>Mono-stable relay, switching behaviour</b>	A relay is referred to as mono-stable when its contacts return to the idle state automatically after the energising parameter (the input voltage) is switched off.
<b>Mono-stable, non-polarized relay, neutral relay</b>	The switch position change in a neutral, mono-stable relay does not depend on the polarity of its excitation.

<b>Mounting distance</b>	Distance between two adjacent components when using parallel, uni-directional positioning; or the distance to other electrical components. Because of the insulation requirements, you may need to increase the minimum gap between the components or select a different positioning. These values refer to components in "single-file arrangement", unless otherwise indicated. Also relevant for this definition: <ul style="list-style-type: none"> <li>• Density of assembly: assembled with minimum mounting clearances; this minimum distance is determined by the insulation requirements at 230 V AC and/or mechanical requirements for the installation(e.g. use of sockets),</li> <li>• Individual installation: components are mounted with gaps so that there is NO thermal influences from adjacent components.</li> </ul>
<b>Mounting position</b>	Mechanical and electronic relays can usually be installed in any position when there are no qualifying limitations. To ensure the proper current flow and heat dissipation, the connections must be properly contacted and the cross-sections must be adequate. Several factors must be taken into consideration when positioning: including the insulation requirements, heat dissipation and the possible mutual magnetic influence.

## N

<b>Nominal current (contact)</b>	Current that a relay contact can switch off or on under specific conditions, or the current that the relay accessories can conduct. The nominal current specification covers the following data, unless otherwise specified: <ul style="list-style-type: none"> <li>• Contact current, switching current</li> <li>• Continuous current limit</li> </ul> The conditions for the relay are specified under the contact lifespan; For accessories, the nominal current is specified for a relative duty cycle of 50 %, at the nominal switching frequency, and for an ambient temperature of 23 °C.
<b>Nominal switching voltage (contact)</b>	Voltage between the switching contacts - before the contact closes or after it opens.
<b>Nominal torque</b>	The specified value for the torque of the screws (screw connection) must not be exceeded.
<b>Number of contacts</b>	Number of working contacts in a relay (normally-open, normally-closed or change-over)

## O

<b>Operating temperature</b>	Permissible ambient temperature – relative to a specific relative humidity – at which a product should be operated at nominal load.
------------------------------	---

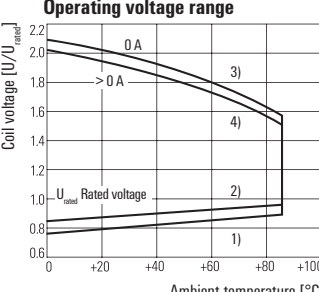
<b>Operational voltage range</b>	<p>Allowable input voltage range – depending on the ambient temperature. The top part of the range is specified by the maximum voltage; the lower part of the range is specified by the response/minimum voltage.</p> <p>Curve 1: response time/minimum voltage <math>U_0</math> (without pre-excitation)  Curve 2: response time/minimum voltage <math>U_1</math> (after pre-excitation)  Curve 3: maximum voltage <math>U_2</math>, contact current = 0 A  Curve 4: maximum voltage at contact current <math>I_{nom}</math></p> 
----------------------------------	---

## P

<b>Packing unit</b>	Indicates the smallest amount (a pack, for example) or the quantity per carton.
<b>Plug-in cycles</b>	Sockets and accessories are designed for 10 insertion cycles without electrical load – unless otherwise specified.
<b>Pollution severity level</b>	<p>Pollution (contamination) includes any foreign material – whether it is solid, liquid or gaseous (ionised gas) – which is capable of influencing the surface resistance of the insulating material. The standard defines four degrees of pollution. Their numbering and classification is based on the quantity of the contaminant or the frequency with which the contaminant reduces the dielectric strength and/or surface resistance.</p> <p>Pollution degree 1:</p> <ul style="list-style-type: none"> <li>there is no contamination or only dry occurrences of non-conductive pollution. The pollution has no influence.</li> </ul> <p>Pollution degree 2:</p> <ul style="list-style-type: none"> <li>there is only non-conductive pollution. Temporary occurrences of conductivity caused by condensation may also occur.</li> </ul> <p>Pollution degree 3:</p> <ul style="list-style-type: none"> <li>conductive pollution or dry, non-conductive pollution that can become conductive due to condensation is likely to occur.</li> </ul> <p>Pollution degree 4:</p> <ul style="list-style-type: none"> <li>the contamination leads to continual conductivity which can be caused by contaminants such as conductive dust, rain or snow.</li> </ul> <p>Note:  Pollution degree 3 is typical for industrial environments and similar settings; pollution degree 2 is typical for households or similar.</p>

<b>Positively-driven contacts</b>	Arrangement of contacts in accordance with EN 50205, with at least one NO and one NC contact; mechanically constructed so that the NO and NC contacts of the entire contact system can never (even in the event of a malfunction) be closed at the same time. Such relays are used in safety engineering controls in order to prevent injury and property damage.
<b>Power rating</b>	The nominal value of the power that is converted when the nominal control voltage is applied.
<b>Protection degree - (IEC 60529), IP</b>	<p>The degree of protection afforded by an enclosure is indicated by the IP Code (IP = International Protection). This specification is equally valid for industrial relays and accessories.</p> <p>For the purposes of "component" relays (such as PCB relays), refer to the RT protection degree.</p> <p>A two-digit number is used to indicate the protection provided against touch contact and foreign bodies (the first number) and against humidity (the second number).</p> <p>Protection levels for touch contact and foreign bodies (the first digit): the first digit indicates the degree of protection inside the housing against ingress of solid foreign objects and against any human access to hazardous parts.</p> <p>0: no protection  1: protection for large body parts with a diameter &gt; 50 mm  2: finger protection (diameter 12 mm)  3: tools and wires (diameter &gt; 2.5 mm)  4: tools and wires (diameter &gt; 1 mm)  5: full protection against touch contact  6: full protection against touch contact</p> <p>Degree of water protection (the second digit)</p> <p>The second digit indicates the degree of protection provided against the ingress of water into the housing:</p> <p>0: no protection  1: protection against vertically falling drops of water  2: protection against water droplets falling diagonally (up to 15°)  3: protection against water spray that falls at an angle up to 60° from vertical  4: protection against splashed water from all sides  5: protection against water jets  6: protection against powerful jets of water (flooding)  7: protection against sporadic submersion  8: protection against constant submersion</p>
<b>Pull-in / drop-out current, AC/DC coil</b>	Value of the coil current at which a relay responds (spark-over) or drops out.

## R

<b>Rated control voltage</b>	The nominal value of the sparkover voltage for the relay.
<b>Rated voltage (Isolation)</b>	Voltage level at which the insulation specifications are measured – this is the basis for sizing the creepage distance.

**Relay times (time response)**

Because of the self-inductance of the coil and the inertia of the moving parts, the steps involved in operating a relay do not occur instantaneously. The following chart illustrates several time-function terms for the main contact variants of non-delayed switching relays.

These specified times are valid when the rated voltage is used for excitation, without other components in series or in parallel to the coil, and at the reference temperature.

- Sparkover time
- Drop-out/reset time
- Bounce time
- Min. excitation period

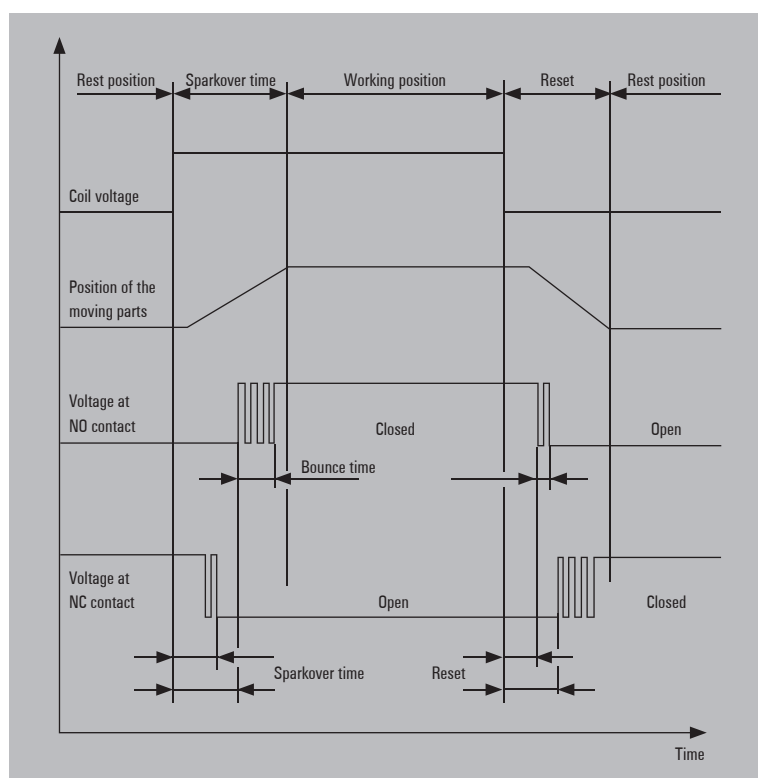

**Relays and sockets**

The relays in this catalogue have been designed, specified and tested in accordance with the relay standard IEC 61810-1 "Electro-mechanical elementary relays - part 1: General considerations and safety-related requirements". Where the appropriate approvals have been specified in the data sheet, the relays and sockets have been tested according to IEC 61810 or EN 61984 and UL 508.

**Reliability**

Electro-mechanical components such as relays are subject to wear (both mechanical and electrical). A typical "bathtub curve" depicts the reliability. This means that there may be isolated statistical exceptions which are below the typical levels of reliability.

**Reset**

Process in which a mono-stable relay resets from the working position to the rest position.



<b>Reset time</b>	Time interval (average) between when a mono-stable relay is in its working state with the coil voltage switched off and the time at which the final output circuit is closed or opened (not including the bounce time). These specified times are valid when the rated voltage is used for excitation, without other components in series or in parallel to the coil, and at the reference temperature.
<b>Reset voltage</b>	Value of the input voltage at which a mono-stable relay reliably returns to the rest position while at the reference temperature.
<b>Response</b>	The process in which the relay transitions from the normally-closed (break) contact position into the normally-open (make) contact position.
<b>Response voltage / drop-out voltage AC/DC coil</b>	Value of the coil voltage at which a relay responds (spark-over) or drops out.
<b>Rest position</b>	The switched position of a mono-stable relay in its unexcited state.
<b>RoHS Directive 2002/95/EC</b>	RoHS stands for "Restriction of (the use of certain) Hazardous Substances". According to the EU Directive 2002/95/EC from 01.07.2006, all EU member nations must forbid the use of hazardous substances which damage human health and the environment (including mercury (Hg), cadmium (Cd), lead (Pb), hexavalent chrome (Cr6), polybrominated biphenyls (PBB) and polybrominated diphenyl ethers (PBDE)) in new electrical and electronic devices. The term "compliant" means that the entire product group meets the requirements of the RoHS Directive. The maximum weight percentage in homogeneous materials is below the limits specified in the directive: 0.1 % for lead, hexavalent chrome, mercury, PBB and PBDE; and below 0.01 % for cadmium, or qualifies for an exemption in accordance with the annex to the RoHS Directive .

## S

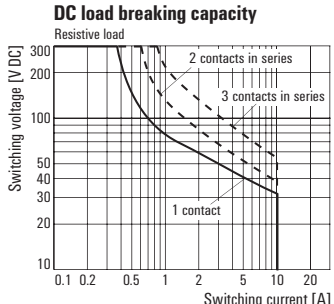
<b>Self-heating</b>	The heating up of an operational component based on the power loss from the relay coil and the switching contacts.
<b>Series-circuit relay contacts</b>	When two or more NO contacts in a relay are connected in series, the contact opening is increased while switching off. Arcs which occur from DC loads are cleared more quickly which results in reduced burn-off on the contact. This increases the electrical lifespan and the breaking (switch-off) capacity.  

## W

<b>SIL</b>	Safety Integrity Level. The components must meet the requirements of IEC 61508 in order to reduce risk. This standard provides general requirements for avoiding and minimising device and equipment outages. It stipulates organisation and technical requirements concerning device design and operation. Four safety levels are defined (from SIL1 for minimal risk to SIL4 for very high risk) for classifying facilities and risk-reduction measures. Measures taken to reduce risk must be more reliable when the classified risk level is higher.
<b>Standardised labelling of connections</b>	A1, A2: coil 13, 14: NO contact (contact closes when applying a voltage to the coil) 11, 12: NC contact 11, 12, 14: CO contact (11 is the common contact, i.e. the root)
<b>Status indicator</b>	The status LED display on the input control circuit can differ from the state of the contact circuit in the following cases: <ul style="list-style-type: none"> <li>• when there are welded-together or broken switching elements,</li> <li>• when there is interference or residual voltages on the signal lines.</li> </ul> A reduction in light intensity may result when the ambient temperatures are greater than 50 °C.
<b>Storage temperature</b>	The permitted ambient temperature, related to a specific relative humidity level, for which the product should be stored while in a current-free state.
<b>Surge voltage category</b>	<p>The overvoltage category of a circuit or an electrical system is numbered conventionally (from I to IV) and is based on limiting the assumed surge voltage values that can occur in a circuit (or electrical system with different mains voltages). The assignment to a particular overvoltage category is dependent on the measures which are used to influence (reduce) the surge voltages.</p> <p>Overvoltage category I</p> <ul style="list-style-type: none"> <li>• Devices that are intended to be connected to the permanent electrical building installation.</li> </ul> <p>The measures for limiting transient surge voltages to the proper level are taken outside of the device. The protective mechanisms can either be in the permanent installation or between the permanent installation and the device.</p> <p>Overvoltage category II</p> <ul style="list-style-type: none"> <li>• Devices that are intended to be connected to the permanent electrical building installation (such as household appliances or portable tools).</li> </ul> <p>Overvoltage category III</p> <ul style="list-style-type: none"> <li>• Devices that are a part of the permanent installation and other devices where a higher degree of availability is required. This includes the distributor panels, power switches, distribution systems (including cable, busbars, distributor boxes, switches and outlets) that are part of the permanent installation, devices intended for industrial use, and devices that are continually connected to the permanent installation (such as stationary motors).</li> </ul> <p>Overvoltage category IV</p> <ul style="list-style-type: none"> <li>• Devices that are intended to be used on or near the power feed in a building's electrical installation – ranging from the main distribution to the mains power system. This includes electrical meters, surge protection switches and ripple control equipment.</li> </ul>

<b>Switch-off delay</b>	Usual time interval from switching off the coil voltage of a switched relay until the first opening or closing of the last output circuit (not including the bounce time).
<b>Switch-on delay</b>	Usual time interval from switching on the coil voltage of an idle relay until the first opening or closing of the last output circuit (not including the bounce time). Coil voltage: pulse or square wave excitation, with rated voltage at the reference temperature of 20 °C.
<b>Switching capacity</b>	The calculated product of the switching current and switching voltage (in W for DC, in VA for AC).
<b>Switching current</b>	Current strength required to switch a relay on or off.
<b>Switching cycle</b>	A single occurrence of the sparkover and subsequent reset.
<b>Switching voltage</b>	The voltage between the switch contacts (contact elements) that is applied prior to the closing or after the opening of the contact (DC for DC voltage; AC for AC voltage).
<b>Switching voltage, max.</b>	The maximum allowable voltage between the contact elements prior to closing and after opening a relay contact.

## T

<b>Test button, manual operation</b>	For operating the relay manually: the test button is used only for test purposes during the initial commissioning and testing of equipment. The test button is not appropriate for normal on/off switching and has not been designed for continuous electrical load while in the mechanical ON position. The button should also not be used as a switch. Before pressing the test button, make sure there is no danger posed by loads or other connected devices. Only trained personnel should operate the test button. This prevents the facility's safety mechanisms from being circumvented and the insulation requirements from being compromised.
<b>Transients</b>	Transients are short-term current or voltage spikes caused by interferences in the mains supply grid or by electromagnetic radiation. On the control side of the optocoupler these can trigger unintended switching operations or, in extreme cases, cause the destruction of the component. In an AC-driven load circuit, transients can lead to the maximum permissible forward voltage being exceeded, which in turn can activate the thyristor or Triac. As these operate at quite high switching speeds, even very short pulses can suffice to falsely trigger a switching operation.
<b>Type code</b>	The ordering scheme gives you the choice of many variations, but not all possible variations in the current product line are established as standard types (building codes, ordering designations). Special versions are available on request to meet customer specifications.

## W

<b>Type of contact</b>	<p>DIN 41020 describes various switching functions of the relay contacts and the specific contact configurations, constructions and descriptions based on these functions.</p> <ul style="list-style-type: none"> <li>• NO (normally open) contact: contact which is closed in the relay's operating position and open in its rest position.</li> <li>• NC (normally closed) contact: contact which is closed in the relay's rest position and open in its working position.</li> <li>• CO (change-over) contact: a CO consists of an NO and an NC contact with a common terminal (root) connection. When changing the switch position, first the previously closed contact opens and then the previously opened contact closes.</li> </ul> <p>Note: A temporary electrical connection may be established between the NC and NO contacts due to the switch-off arc.</p>
<b>Type of insulation</b>	<p>Quality of the insulation system, depending on the design and application conditions:</p> <ul style="list-style-type: none"> <li>• Functional insulation: insulation between live components – necessary so the relay functions properly.</li> <li>• Basic insulation: insulation of live parts to provide basic protection against electrical shock.</li> <li>• Doubled insulation: consisting of a base insulation and additional insulation.</li> <li>• Reinforced insulation: a single "enhanced" insulation of active components, which ensures the same protection against electric shock as doubled insulation. The doubled insulation is composed of a base insulation and an additional insulation; the extra insulation protects against electric shock if the basic insulation fails.</li> </ul>

**U**

<b>Usage category according to EN 60947 (mechanical relays)</b>	AC1: non-inductive or slightly inductive load, such as heating elements AC14: small electro-magnetic loads (< 72 VA), such as mini-contactors AC15: small electro-magnetic loads (< 72 VA), such as power contactors DC1: non-inductive or slightly inductive load, such as heating elements DC13: electro-magnetic loads, such as solenoid valves
---	--

**W**

<b>Wash resistant</b>	Wash-resistant relays can withstand a washing process. During the wash process, none of the cleaning agent should be able to penetrate inside the relay.
<b>Withstand test voltage</b>	The voltage applied to a device under specific test conditions which causes no breakthrough or flash-over of the test piece.



# Definition / mode of operation

## Opto modules – mode of operation

Opto modules are electronic components for switching load circuits by means of a control circuit. On the one hand this allows applications with different performance ratings to be operated by relatively low switching currents. And on the other *electrical isolation*\*) between control and load circuits is provided to assure protection of components should a malfunction occur.

In contrast to electromechanical relay modules opto modules do not have any mechanical parts that are prone to wear. To enable the switching operation a light signal is triggered via an LED in the control circuit that causes a light-sensitive semiconductor receiver to complete a connected load circuit. Transmitter (LED) and receiver (for example a phototransistor) are embedded in a light conducting plastic material and encased in a light-proof casing that protects against outside influences.

Two design types are differentiated:

**Face-to-face design** with LED and transistor mounted across from each other with direct light contact

**Coplanar design** with LED and transistor on the same level. In this case the beam of light is transferred by reflection according to the principle of fibre-optics.

## Opto module

The voltage, which can be applied to the opto output itself, is restricted by the sensitivity of the semiconductor receiver (phototransistor). In applications in which only low currents or voltages are required in the load circuit it is possible to use the component without an additional auxiliary circuit in an opto module.

## Solid-State Relay

In order to switch higher currents it is necessary to make adaptations to accommodate the different performance levels of the phototransistor and the load circuit (switching amplification).

Modules other than optos equipped with a switching amplifier are called **solid-state relays** (SSR).

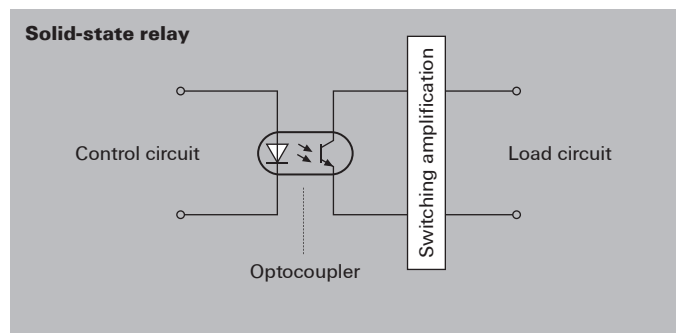
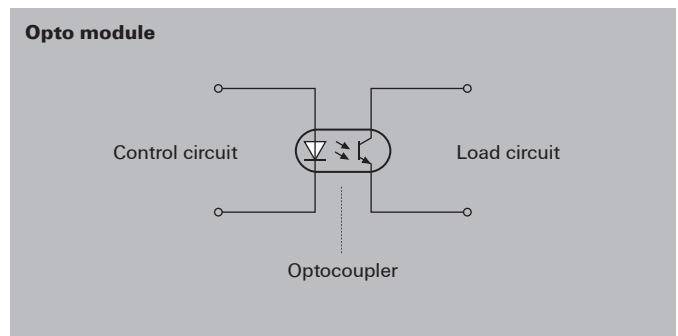
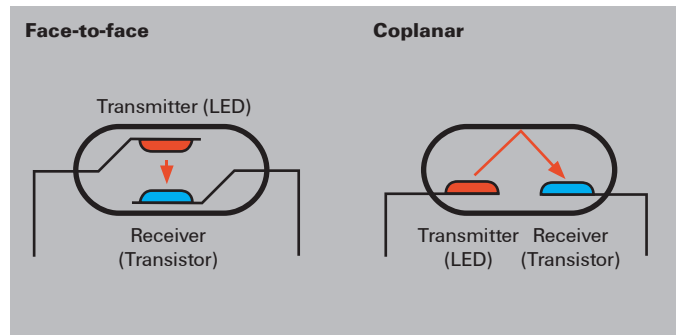
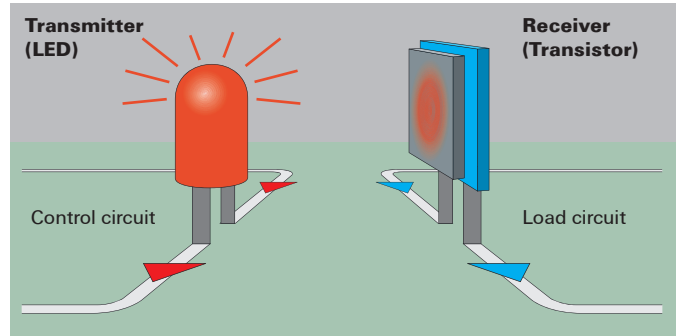

\* Refer to page W.36 in the Glossary for a detailed explanation of this term.

## Basic functions

Opto modules and solid-state relays are generally used in the following fields of applications:

### Potential isolation

Many applications require that the control circuit is electrically isolated from the load circuit. This primarily protects the control level from interference from the field, such as:

- Interference currents e.g. from *earth and ground loops*\*)
- Interference pulses e.g. from inductive effects of *transients*\*)

The separation of the control and load circuits in the opto module provides the required isolation. However, this must withstand an isolation test of at least 2.5 kV in all opto modules and solid-state relays. To guarantee isolation it is necessary that a minimum of 3 mm clearance and *creepage distance*\*) be maintained in all components.

### Signal conditioning

The separation of the load and control circuits, in conjunction with the variety of options this offers to configure both circuits separately, means that opto modules are often used for signal conditioning purposes. This allows the different electrical potentials of signals from the control and load circuits (for example sensors and control) to be equalised.

### Switching amplification

Applications with current and voltage values that exceed the capacity of the phototransistor require an auxiliary circuit on the output side of the opto module for switching amplification purposes. During the switching operation the opto module LED activates a base current in the phototransistor. This activates a second semiconductor (transistor, thyristor) selected to meet application requirements which then becomes conductive for the load current.

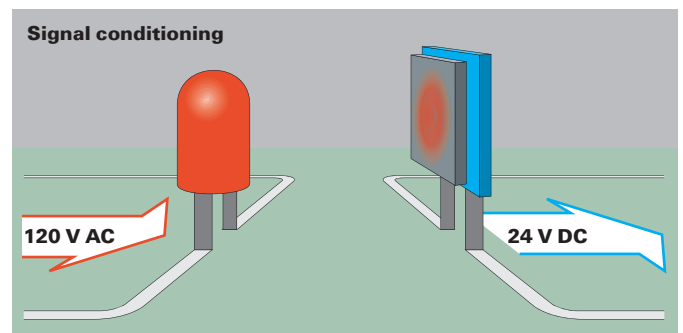
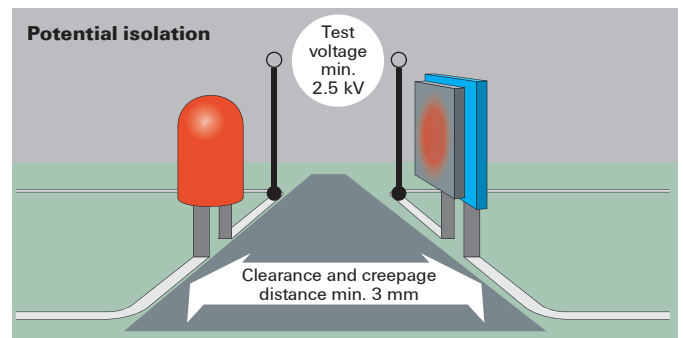

\* Refer to page W.36 in the Glossary for a detailed explanation of this term.



# Control circuit

## The input circuits (control circuit)

Most industrial applications cannot be connected directly to an opto module, generally requiring voltage regulation by means of series-connected resistances or capacitors. To obtain exact-as-possible switching points a *Schmitt Trigger*\*) can be used to assign the control signals an unambiguous status (0 - 1) when moving from high to low or low to high, which is then passed on to the opto module.

Depending on the design, all Weidmüller opto modules and solid-state relays are equipped with suitable protective devices (varistors, diodes) and filters to protect against interference pulses from the control circuit.

### DC input:

An additional reverse-polarity protection diode guarantees protection against the opto module being destroyed if the control voltage is incorrectly wired. The switching status of the control circuit is signalled by a status indicator.

### AC/DC input:

A rectifier with smoothing capacitor is connected in series for AC control voltages. Reverse polarity protection for DC current is not necessary. The following construction corresponds to a DC circuit.

Due to the smoothing capacitor the switching frequency of AC control signals is fundamentally less than half the mains frequency. A higher switching frequency would result in the control signal being constantly switched through in rhythm with the mains frequency.

The advantage of being able to choose between an AC or a DC current input contrasts with the disadvantage that the smoothing capacitor also restricts the switching frequency of the DC control signal.

### AC input:

The circuit diagram corresponds in principle with an AC/DC circuit. Instead of series resistors it is possible to use capacitors to regulate the voltage in a purely AC operation. In contrast to resistors there is no power loss with capacitors and as a result no heat that needs to be dissipated.

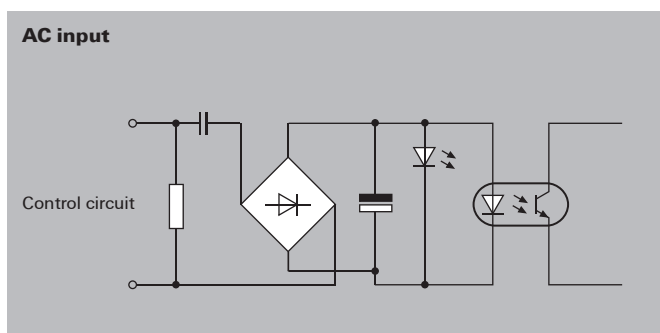
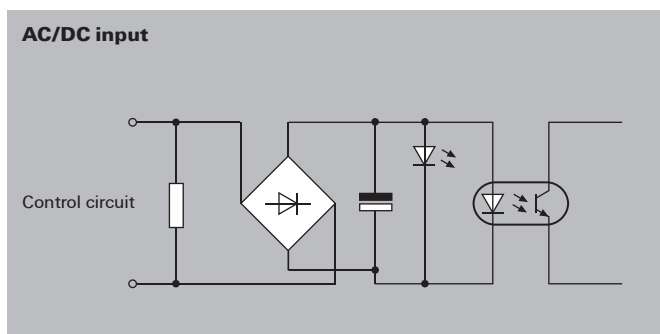
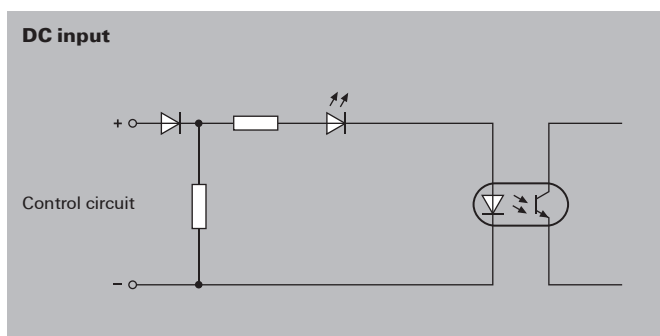
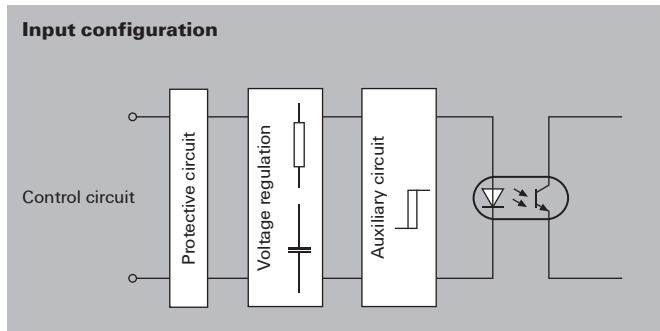

\* Refer to page W.36 in the Glossary for a detailed explanation of this term.

# Load circuit

## The output circuit (load circuit)

As a rule, an operating voltage range is stated for the rated switching voltage of opto modules and solid-state relays (for example 5 ... 48 V DC); it is not permitted to exceed or fall below this value.

The same applies to continuous current. Exceeding this value too often can result in premature wear-out and destruction of the opto modules semiconductor.

As a direct correlation exists between the current and ambient temperature a *derating curve*\*) is provided for all opto modules and solid-state relays.

Overvoltages are shunted by protective devices such as diodes or varistors.

To prevent damage caused by current spikes (for example starting or off pulses) some modules are equipped with a *power boost*\*) which is capable of carrying higher levels of current than the maximum stated for a short period of time.

It is possible to connect AC or DC loads subject to the output circuit having corresponding amplifier semiconductors.

### DC output:

With a 2-pole DC output the connection terminals are to be considered in the same manner as with a conventional switch. All that is required is that care is taken to observe the predetermined polarity.

With a 3-pole DC connection an auxiliary voltage assists the output circuit to control the amplifying transistor more precisely. Several applications also require this auxiliary voltage for short-circuit protection in the interface or protective circuitry.

### AC output:

To activate AC switching and control devices a semiconductor is connected on the load side of the opto module component to switch the AC voltage (TRIAC or thyristor).

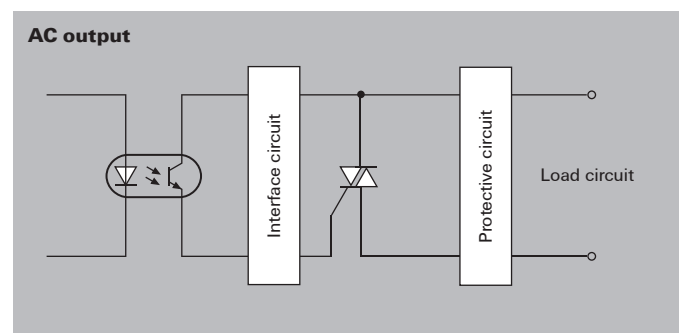
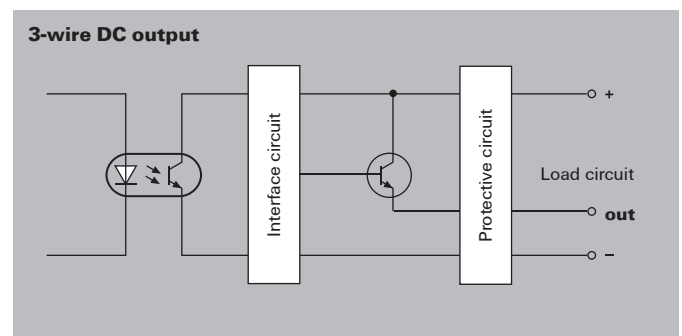
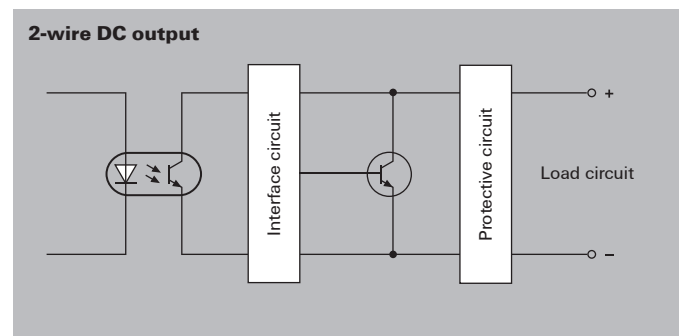
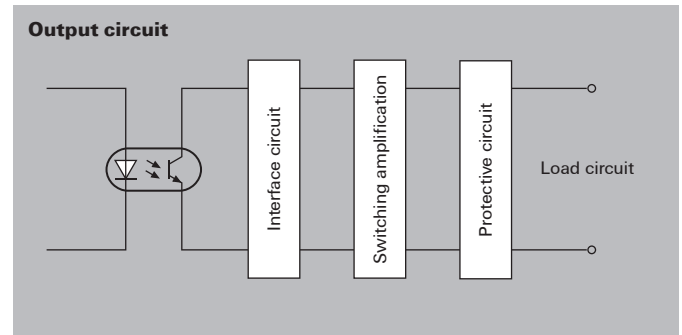

\* Refer to page W.36 in the Glossary for a detailed explanation of this term.

## Switching amplification

The phototransistor of the opto module has a low current and voltage rating. As a consequence, an additional semiconductor element is accessed for larger output loads that is capable of switching the corresponding rated switching voltages and rated switching currents.

### Bipolar Transistor (DC)

Used for low currents (0.5 A).

The bipolar transistor has short response times, which makes high switching frequencies possible as a result.

### MOSFET (DC)

Used for high load currents (up to 10 A).

The low contact resistance of the MOSFET create only very small leakage currents ( $< 10 \mu\text{A}$ ) with low power loss.

### Triac (AC)

A Triac combines the functional principle of antiparallel connected thyristors in a single component.

The mode of function of a thyristor is comparable with that of a one-way diode. Therefore, an opposing parallel circuit configuration consisting of two thyristors is used for AC currents.

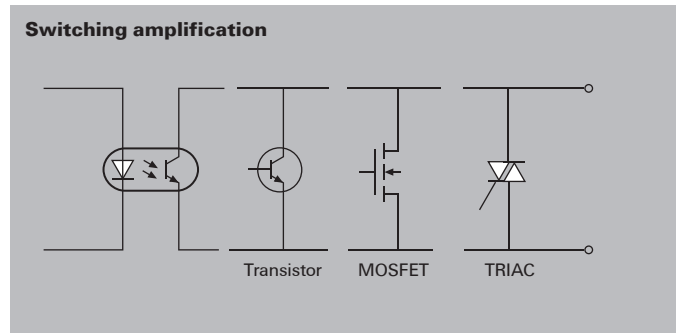

# Switching diverse loads

The different types of loads resulting from the possible applications (resistive, inductive, capacitive loads) represent a particular challenge for the load circuit arrangements of opto modules and solid-state relays. With reference to the planned application, one should always be aware of what effects the loads will have on the modules and how the corresponding protective devices have to be designed.

Generally speaking, it must be ensured that the power loss at the amplifier semiconductor does not exceed the permitted limit for any length of time. This would lead to overheating and finally to the destruction of the component.

## Switching resistive loads

Due to the fact that in resistive loads the amperage in the load circuit and the voltage across the amplifier semiconductor are inversely proportional to one another these do not generally pose a problem. It is sufficient to adhere to the maximum current and voltage ratings of the modules.

Switching glow lamps represents a special case. It is possible that when being switched on that overcurrents 10 to 20 times the operating current can occur due to the low cold resistance.

Therefore, the components must be designed to cope with these possible overloads situations which correspond to the effect of capacitive loads.

## Switching capacitive loads

Capacitive loads occur if there is a capacitor in the load circuit. The effect is similar to a short-circuit at the point of activation and results in a high inrush current.

If this current is not limited it can lead to the destruction of the amplifier semiconductor.

## Switching inductive loads

Problems can arise with inductive loads when they are being switched off, in particular when coils are used in the load circuit. The flow of current in the coil builds up a magnetic field that suddenly collapses and creates a high induction voltage.

This voltage spike has to be short-circuited via a diode connected in parallel (free-wheeling diode). However, the time required leads to delayed release.

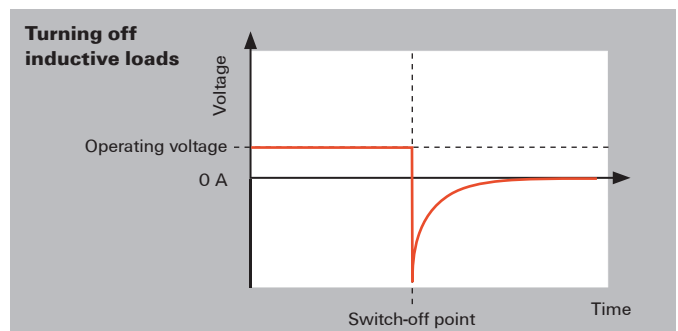
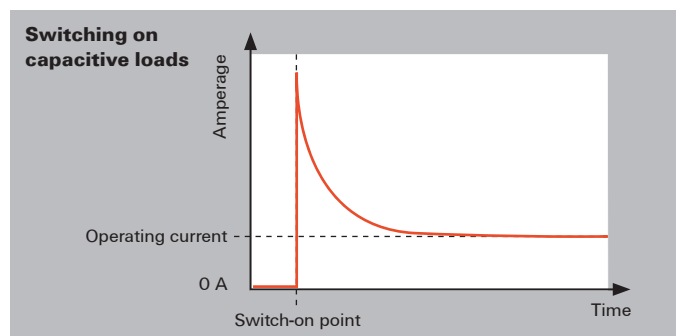

# Protective measures

The construction of the opto module enables fast and sensitive switching, however, the component is also more prone to interference. For this reason, all Weidmüller opto modules and solid-state relays are equipped with a variety of measures to protect against overloading and interference pulses.

### Free-wheeling diodes (DC)

Free-wheeling diodes are used primarily to protect against overvoltages, which occur through self-induction when switching off inductive DC loads (electric motors, relay coils). Voltage spikes are limited to the equivalent value of the diode forward voltage and excess voltage is discharged via the diode. However, this leads to a delay in the voltage drop and as such also delays the switching operation.

### Zener diode / suppressor diode (DC)

These function as normal diodes in the forward conducting direction. In the blocking direction they become low resistant at a certain voltage (breakdown voltage). High levels of overvoltages can lead to the destruction of the zener diode / suppressor diode.

### Varistor (AC/DC)

The functional principle of the varistor is also based on a breakdown voltage, but with faster reaction times. This allows higher levels of energy to be shunted, however, these lead to the component aging. This in turn reduces the breakdown voltage over time and increases the leakage current.

### RC-element (AC)

The RC element compensates voltage spikes by means of a capacitor. Due to the charging and discharging characteristics interference pulses are filtered out when the voltage is rising and not first when overload is reached. For this reason, RC elements are used to protect against interference pulses and exclude faulty switching operations.

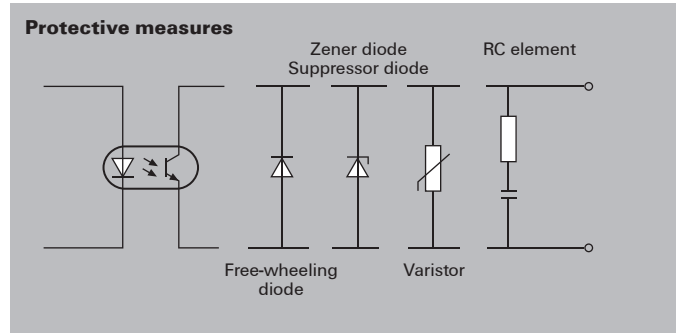



## Glossary: Solid-state relays

### A

<b>AC</b>	Refers both to alternating values (such as voltage or current) as well as to those devices and variables which reference these devices. Specifications are valid for 50 Hz, unless otherwise indicated.
<b>Approvals and testing marks</b>	<p>Testing approvals are independent confirmation from governmental or private registration services and testing facilities. They certify that the product complies with the relevant regulations and maintain the specified product characteristics. Note: The ordering scheme gives you the choice of many variations, but not all variations are established as standard types (order numbers). Therefore, they may not be included in the list of approved relays. Technical specifications and list of approved types are available on request.</p> <p>CSA Canadian Standards Association, Canada          GL Germanischer Lloyd, Germany          TÜV Technical Monitoring Association, Germany          UL Underwriters Laboratories, Inc., USA;          UR Component Recognition Mark for the United States          cUR UL Component Recognition Mark for Canada          cURus UL Component Recognition Mark for the United States and Canada          cULus UL Component Listing Mark for the United States and Canada          VDE VDE testing location, Germany (advisory reports with production monitoring)</p>

### C

<b>CE</b>	<p>Abbreviation for Communauté Européenne (the European Community). The CE marking is a way for the manufacturer to confirm that their product complies with the relevant EC directives and the "essential requirements" contained therein. The EMC Directive 2004/108/EC and Low Voltage Directive 2006/95/EC are currently binding.</p>
-----------	---

**Clearance and creepage distances**

Clearance and creepage distances are critical factors which influence the insulation capability of electrical components. The creepage distance denotes the minimum clearance that two live parts along a surface must have in order to prohibit a flow of current across the insulating material at the specified operating voltage.

In addition to the operating voltage, the choice of insulating material (material group) and the protective measures to counteract pollution (pollution severity) affect the creepage distance. The clearance distance denotes the minimum direct clearance (through the air) that two live parts must have to one another in order to prohibit a charge passing through the air (an arc). The expected surge voltage (rated impulse voltage) forms the basis for calculating the distances. The surge protection category and pollution severity are further factors that influence dimensional design considerations.

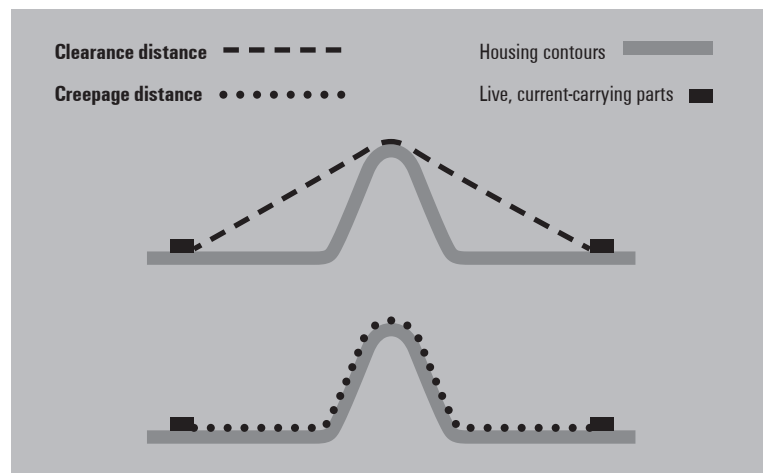
**Continuous current**

The current can be continuously conducted without exceeding the overheating values under defined conditions.

**Cut-in (switch-on) voltage**

The voltage level at which an opto module or solid-state relay is conductive.



**D**

<b>DC</b>	Refers to the electrical variables such as voltage or current (DC, DC voltage) that are not dependent on time.
<b>Derating / derating curve</b>	<p>The continuous current is reduced at higher ambient temperatures; this is shown using a derating curve (a load reduction curve). Current flow generates heat, which increases as the current increases. Electrical components have an upper temperature limit which limits their ability to function. The temperature influencing the components is a combination of the ambient temperature and the heat generated by the current. So to ensure that the limit temperature is not exceeded, the current must be reduced when the overall temperature rises. The derating curve depicts this relationship between the prevailing temperature and the resulting maximum amperage with regard to the limit temperature.</p> <div data-bbox="593 880 1359 1214" data-label="Figure"> </div>
<b>Dimensions</b>	<p>Dimensions in millimetres.</p> <div data-bbox="593 1310 1034 1635" data-label="Diagram"> </div>
<b>DIN rail</b>	Unless otherwise noted, Weidmüller's products are built and tested for mounting on DIN rail (rails according to TH35-7.5 / EN60175). Other installations (e.g. TH35-15) may function but have not been tested or approved.
<b>Dropout voltage</b>	The voltage level at which an opto module or solid-state relay blocks itself.

**W**

<p><b>E</b></p> <p><b>Earth and ground loops</b></p>	<p>Denote the connection of two potentials via their earth or ground connection. A potential difference between the earth or ground connection of two devices (for example, a sensor and controller) that are directly wired to one another causes current flow via the earth of the shared housing. These interference currents can lead to different problems, for example in the acquisition of measurement signals or when controlling actuators. When transmitting switching signals or measurement signals using a device with electrical isolation between the control and load circuits, it is important that a closed circuit via the earth or ground connection can never occur – so that no interference currents are generated.</p> <div data-bbox="592 815 1361 1283"> </div>
<p><b>F</b></p> <p><b>Flammability according to UL</b></p>	<p>Indicates the flammability class according to the specification from UL 94 (Underwriters Laboratories, Inc., USA). Flammability tests according to UL 94: for testing plastic materials and classifying the propagation/extinction characteristics when the material burns. The UL 94 flammability classes which are relevant to the relay are V-0, V-1, V-2 and HB.</p>
<p><b>G</b></p> <p><b>Galvanic isolation</b></p>	<p>Potential-free isolation between electrical components. Electrical (or galvanic) isolation means that no charge can flow from one circuit to another. There is no conductive electrical connection between the circuits. The circuits can nevertheless exchange electrical power or signals via magnetic fields, infrared radiation or by charge displacements.</p>

## H

<b>Humidity / condensation</b>	<p>Standard conditions: annual average relative humidity &gt; 75 % at an ambient temperature of 21 °C, in 30 days, evenly distributed throughout the year, and 95 % at ambient temperature w of 25 °C. On other days: occasionally 85 % at 23 °C. No icing or condensation is allowed - affects storage and/or operation.</p> <p>When storing or operating under other conditions, you must takes steps to avoid temperature changes which could cause icing or condensation. Operating and storage should be within the limits specified in the graphic.</p> <div data-bbox="592 786 922 1088" style="text-align: center;"> <p><b>Environmental conditions</b></p> <p>Relative humidity (% RH)</p> <p>Ambient temperature [°C]</p> <p>Area of usage and storage</p> <p><math>T_{amb} &gt; 0^\circ</math> Avoid condensation</p> <p><math>T_{amb} &lt; 0^\circ</math> Avoid icing</p> </div>
--------------------------------	--

## I

<b>Impulse withstand voltage</b>	<p>The highest withstand voltage of a specified shape and polarity that does not lead to an insulation breakthrough or flash-over, under the specific conditions.</p>
<b>Inductive loads</b>	<p>Refer to load category</p>
<b>Input frequency</b>	<p>The number of switching operations that occur in a specific unit of time. The maximum switching frequency for medium loads may be higher than the value specified for the nominal load, as long as the switching of the load does not result in an increased temperature.</p>
<b>Insulating material group</b>	<p>According to their CTI (comparative tracking index) values, the insulating materials are categorised into one of the following four groups:</p> <p>Group I 600 CTI          Group II 400 CTI &lt; 600          Group IIIa 175 CTI &lt; 400          Group IIIb 100 CTI &lt; 175</p> <p>The figures for the comparative tracking index, according to IEC 60112 (DIN IEC 60112 / DIN VDE 0303-1) are determined using special samples prepared for this purpose with test solution A.</p>
<b>Insulation according to EN 50178</b>	<p>Specifications for insulation coordination with:</p> <ul style="list-style-type: none"> <li>• Type of insulation</li> <li>• Nominal voltage of the supply system</li> <li>• Pollution severity level</li> <li>• Impulse withstand voltage</li> <li>• Surge voltage category</li> </ul>

## W

**L**

<b>Leakage current</b>	The current on the load side of an opto module or solid-state relay that flows towards the output stage while in a blocked state.
<b>Load category (solid-state relay)</b>	Classification of the load of a solid state relay, in accordance with EN 62314 LC A – resistive loads or minimally inductive loads LC B – motor loads LC C – electrical discharge lamps LC D – incandescent filament lamps LC E – transformers LC F – capacitive loads

**M**

<b>Max. switching current</b>	The max. switching current indicates the maximum level of current that can be switched.
<b>Max. switching power</b>	The switching capacity is calculated as the product of switching voltage and switching current (in VA for AC / in W for DC).
<b>Mounting distance</b>	Distance between two adjacent components in parallel, uni-directional positioning; or the proximity to other electrical components. Because of the insulation requirements, you may need to increase the minimum distance between the components or select a different positioning. These values refer to components in "single-file arrangement", unless otherwise indicated. Also relevant for this definition: <ul style="list-style-type: none"> <li>• density of assembly: assembled with minimum mounting clearances; this minimum distance is determined by the insulation requirements at 230 V AC and/or mechanical requirements for the installation(e.g. use of sockets),</li> <li>• individual installation: components are mounted with gaps so that there are no thermal influences from adjacent components.</li> </ul>
<b>Mounting position</b>	Mechanical and electronic relays can usually be installed in any position when there are no qualifying limitations. To ensure the proper current flow and heat dissipation, the connections must be properly contacted and the cross-sections must be adequate. Several factors must be taken into consideration when positioning: including the insulation requirements, heat dissipation and the possible mutual magnetic influence.

**N**

<b>Nominal control current</b>	Input current that is required, under specific conditions, to switch the output.
<b>Nominal switching voltage</b>	Voltage at the output - before the closing or opening of the contact.
<b>Nominal torque</b>	The specified value for the torque of the screws (screw connection) must not be exceeded.

**O**

<b>Operating temperature</b>	Permissible ambient temperature – relative to a specific relative humidity – at which a product should be operated at nominal load.
------------------------------	---

**P**

<b>Packing unit</b>	Indicates the smallest amount (a pack, for example) or the quantity per carton.
<b>Plug-in cycles</b>	Sockets and accessories are designed for 10 insertion cycles without electrical load – unless otherwise specified.
<b>Pollution severity level</b>	<p>Pollution (contamination) includes any foreign material – whether it is solid, liquid or gaseous (ionised gas) – which is capable of influencing the surface resistance of the insulating material. The standard defines four degrees of pollution. Their numbering and classification is based on the quantity of the contaminant or the frequency with which the contaminant reduces the dielectric strength and/or surface resistance.</p> <p>Pollution degree 1:</p> <ul style="list-style-type: none"> <li>• there is no contamination or only dry occurrences of non-conductive pollution. The pollution has no influence.</li> </ul> <p>Pollution degree 2:</p> <ul style="list-style-type: none"> <li>• there is only non-conductive pollution. Temporary occurrences of conductivity caused by condensation may also occur.</li> </ul> <p>Pollution degree 3:</p> <ul style="list-style-type: none"> <li>• conductive pollution or dry, non-conductive pollution that can become conductive due to condensation is likely to occur.</li> </ul> <p>Pollution degree 4:</p> <ul style="list-style-type: none"> <li>• the contamination leads to continual conductivity which can be caused by contaminants such as conductive dust, rain or snow.</li> </ul> <p>Note: Pollution degree 3 is typical for industrial environments and similar settings; pollution degree 2 is typical for households or similar.</p>
<b>Power rating</b>	The nominal value of the power that is converted when the nominal control voltage is applied.

<b>Protection degree - (IEC 60529), IP</b>	<p>The degree of protection afforded by an enclosure is shown using the IP Code (IP = International Protection). This information is equally relevant for industrial relays and accessories.</p> <p>For the purposes of “component” relays (such as PCB relays), refer to the RT protection degree.</p> <p>A two-digit number is used to indicate the protection provided against touch contact and foreign bodies (the first number) and against humidity (the second number).</p> <p>Protection levels for touch contact and foreign bodies (the first digit): the first digit indicates the degree of protection inside the housing against ingress of solid foreign objects and against any human access to hazardous parts.</p> <p>0: no protection  1: protection for large body parts with a diameter &gt; 50 mm  2: finger protection (diameter 12 mm)  3: tools and wires (diameter &gt; 2.5 mm)  4: tools and wires (diameter &gt; 1 mm)  5: full protection against touch contact  6: full protection against touch contact</p> <p>Degree of water protection (the second digit)</p> <p>The second digit indicates the degree of protection provided against the ingress of water into the housing:</p> <p>0: no protection  1: protection against vertically falling drops of water  2: protection against water droplets falling diagonally (up to 15°)  3: protection against water spray that falls at an angle up to 60° from vertical  4: protection against splashed water from all sides  5: protection against water jets  6: protection against powerful jets of water (flooding)  7: protection against sporadic submersion  8: protection against constant submersion</p>
--	--

## R

<b>Rated control voltage</b>	The nominal value of the sparkover (response) voltage for the solid-state relay
<b>Rated voltage (Isolation)</b>	Voltage level at which the insulation specifications are measured – this is the basis for sizing the creepage distance.
<b>ROHS Directive 2002/95/EC</b>	<p>RoHS stands for the “Restriction of (the use of certain) Hazardous Substances” According to the EU Directive 2002/95/EC from 01.07.2006, all EU member nations must forbid the use of hazardous substances which damage human health and the environment (including mercury (Hg), cadmium (Cd), lead (Pb), hexavalent chrome (Cr6), polybrominated biphenyls (PBB) and polybrominated diphenyl ethers (PBDE)) in new electrical and electronic devices.</p> <p>The term “compliant” means that the entire product group meets the requirements of the RoHS Directive. The maximum weight percentage in homogeneous materials is below the limits specified in the directive: 0.1 % for lead, hexavalent chrome, mercury, PBB and PBDE; and below 0.01 % for cadmium, or qualifies for an exemption in accordance with the annex to the RoHS Directive .</p>

**S**

<b>Schmitt trigger</b>	Strictly speaking, switching voltages for digital control follow an analogue pattern (no changeover from 0 to 1 between maximum and minimum voltages). This can lead to inaccuracies in switching results, above all when signals are being transmitted rapidly. In this case, the Schmitt trigger functions as a threshold switch. If the threshold voltage set in the Schmitt Trigger is exceeded, the output assumes the maximum possible output voltage (logic 1). Otherwise it is the minimum possible output voltage (logic 0). The Schmitt trigger is normally designed with a hysteresis. The threshold voltage set for activating is higher than that for deactivating. That prevents small irregularities from triggering a switching operation.
<b>Self-heating</b>	The heating up of an operational component based on the power loss from the relay coil and the switching contacts. For semiconductors (such as a transistor output), the increase in heat is caused by power loss.
<b>Short-circuit-proof</b>	Shuts off the output stage of a solid-state relay when there is a short circuit, in order to prevent the output circuit from being damaged.
<b>Solid-state relay</b>	Semiconductor relay that uses an electronic component as the switching mechanism, such as a transistor, thyristor or Triac. Semiconductor relays function with no wearing parts and have a high switching frequency compared with normal relays. But compared to normal relays they have a higher power loss in the load current circuit. An integrated optocoupler is used for galvanic isolation.
<b>Status indicator</b>	The status LED display on the input control circuit can differ from the state of the contact circuit in the following cases: <ul style="list-style-type: none"> <li>• when there are welded-together or broken switching elements,</li> <li>• when there is interference or residual voltages on the signal lines.</li> </ul> A reduction in light intensity may result when the ambient temperatures are greater than 50 °C.
<b>Storage temperature</b>	The permitted ambient temperature, related to a specific relative humidity level, for which the product should be stored while in a current-free state.

**W**

<b>Surge voltage category</b>	<p>The overvoltage category of a circuit or an electrical system is numbered conventionally (from I to IV) and is based on limiting the assumed surge voltage values that can occur in a circuit (or electrical system with different mains voltages). The assignment to a particular overvoltage category is dependent on the measures which are used to influence (reduce) the surge voltages.</p> <p>Overvoltage category I</p> <ul style="list-style-type: none"> <li>• Devices that are intended to be connected to the permanent electrical building installation.</li> </ul> <p>The measures for limiting transient surge voltages to the proper level are taken outside of the device. The protective mechanisms can either be in the permanent installation or between the permanent installation and the device.</p> <p>Overvoltage category II</p> <ul style="list-style-type: none"> <li>• Devices that are intended to be connected to the permanent electrical building installation (such as household appliances or portable tools).</li> </ul> <p>Overvoltage category III</p> <ul style="list-style-type: none"> <li>• Devices that are a part of the permanent installation and other devices where a higher degree of availability is required. This includes the distributor panels, power switches, distribution systems (including cables, busbars, distributor boxes, switches and outlets) that are part of the permanent installation, devices intended for industrial use, and devices that are continually connected to the permanent installation (such as stationary motors).</li> </ul>
<b>Switch-off delay</b>	The usual time interval from switching off the control voltage of a conducting solid-state relay to the time when the output circuit is blocked.
<b>Switch-on delay</b>	The usual time interval from switching on the control voltage of a closed solid-state relay to the time when the output circuit is conductive.



**T**

<b>Transients</b>	Transients are short-term current or voltage peaks caused by interferences in the mains supply grid or by electromagnetic radiation. On the control side of the optocoupler these can trigger unintended switching operations or, in extreme cases, cause the destruction of the component. In an AC-driven load circuit, transients can lead to the maximum permissible forward voltage being exceeded, which in turn can activate the thyristor or Triac. As these operate at quite high switching speeds, even very short pulses can suffice to falsely trigger a switching operation.
<b>Type of insulation</b>	Quality of the insulation system, depending on the design and application conditions: <ul style="list-style-type: none"> <li>• Functional insulation: insulation between live components – necessary so the relay functions properly.</li> <li>• Basic insulation: insulation of live parts to provide basic protection against electrical shock.</li> <li>• Doubled insulation: consisting of a base insulation and additional insulation.</li> <li>• Reinforced insulation: a single “enhanced” insulation of active components, which ensures the same protection against electric shock as doubled insulation. The doubled insulation is composed of a base and an additional insulation; the extra insulation protects against electric shock if the basic insulation fails.</li> </ul>

**V**

<b>Voltage drop</b>	The reduction of voltage via the opto module, when measured under full load
---------------------	---

**W**

<b>Withstand test voltage</b>	The voltage applied to a device under specific test conditions which causes no breakthrough or flash-over of the test piece.
-------------------------------	--

# Index

<b>Index</b>	Index Type	X.2
	Index Order No.	X.5
	Addresses worldwide	X.10









Order No.	Type	Page
-----------	------	------

## 052000000

0526700000	ISPF QB75 SW	A.78
0526760000	ISPF QB75 RT	A.78
0526780000	ISPF QB75 BL	A.78

## 053000000

0535200000	QB 75/6.2/15	A.78
------------	--------------	------

## 106000000

1061200000	WEW 35/2	A.90
1061210000	WEW 35/2 SW	A.51
1061210000	WEW 35/2 SW	A.78

## 112000000

1122740000	TRS 5VDC 1CD	A.9
1122750000	TRS 12VDC 1CD	A.9
1122770000	TRS 24VDC 1CD	A.9
1122780000	TRS 24VDC 1CD	A.9
1122790000	TRS 48VDC 1CD	A.9
1122800000	TRS 60VDC 1CD	A.9
1122810000	TRS 120VDC 1CD	A.9
1122820000	TRS 230VDC 1CD	A.9
1122830000	TRS 120VAC RC 1CD	A.9
1122840000	TRS 230VAC RC 1CD	A.9
1122850000	TRS 24-230VDC 1CD	A.12
1122860000	TRZ 5VDC 1CD	A.9
1122870000	TRZ 12VDC 1CD	A.9
1122880000	TRZ 24VDC 1CD	A.9
1122890000	TRZ 24VDC 1CD	A.9
1122900000	TRZ 48VDC 1CD	A.9
1122910000	TRZ 60VDC 1CD	A.9
1122920000	TRZ 120VDC 1CD	A.9
1122930000	TRZ 230VDC 1CD	A.9
1122940000	TRZ 120VAC RC 1CD	A.9
1122950000	TRZ 230VAC RC 1CD	A.9
1122970000	TRZ 24-230VDC 1CD	A.12
1122980000	TRS 5VDC 1CD AU	A.11
1122990000	TRS 12VDC 1CD AU	A.11
1123000000	TRS 24VDC 1CD AU	A.11
1123010000	TRS 24VDC 1CD AU	A.11
1123020000	TRS 48VDC 1CD AU	A.11
1123030000	TRS 60VDC 1CD AU	A.11
1123040000	TRS 120VDC 1CD AU	A.11
1123050000	TRS 230VDC 1CD AU	A.11
1123070000	TRS 120VAC RC 1CD AU	A.11
1123080000	TRS 230VAC RC 1CD AU	A.11
1123090000	TRS 24-230VDC 1CD AU	A.13
1123100000	TRZ 5VDC 1CD AU	A.11
1123110000	TRZ 12VDC 1CD AU	A.11
1123120000	TRZ 24VDC 1CD AU	A.11
1123130000	TRZ 24VDC 1CD AU	A.11
1123140000	TRZ 48VDC 1CD AU	A.11
1123150000	TRZ 60VDC 1CD AU	A.11
1123170000	TRZ 120VDC 1CD AU	A.11
1123180000	TRZ 230VDC 1CD AU	A.11
1123190000	TRZ 120VAC RC 1CD AU	A.11
1123200000	TRZ 230VAC RC 1CD AU	A.11
1123210000	TRZ 24-230VDC 1CD AU	A.13
1123220000	TRS 5VDC 1CD EMPTY	A.50
1123230000	TRS 12VDC 1CD EMPTY	A.50
1123240000	TRS 24VDC 1CD EMPTY	A.50
1123250000	TRS 24VDC 1CD EMPTY	A.50
1123270000	TRS 48VDC 1CD EMPTY	A.50
1123280000	TRS 60VDC 1CD EMPTY	A.50
1123290000	TRS 120VDC 1CD EMPTY	A.50
1123300000	TRS 230VDC 1CD EMPTY	A.50
1123310000	TRS 120VAC RC 1CD EMPTY	A.50
1123320000	TRS 230VAC RC 1CD EMPTY	A.50
1123330000	TRS 24-230VDC 1CD EMPTY	A.50
1123340000	TRZ 5VDC 1CD EMPTY	A.50
1123350000	TRZ 12VDC 1CD EMPTY	A.50
1123370000	TRZ 24VDC 1CD EMPTY	A.50
1123380000	TRZ 24VDC 1CD EMPTY	A.50
1123390000	TRZ 48VDC 1CD EMPTY	A.50
1123400000	TRZ 60VDC 1CD EMPTY	A.50
1123410000	TRZ 120VDC 1CD EMPTY	A.50
1123420000	TRZ 230VDC 1CD EMPTY	A.50
1123430000	TRZ 120VAC RC 1CD EMPTY	A.50
1123440000	TRZ 230VAC RC 1CD EMPTY	A.50
1123450000	TRZ 24-230VDC 1CD EMPTY	A.50
1123470000	TRS 5VDC 2CD	A.23
1123480000	TRS 12VDC 2CD	A.23
1123490000	TRS 24VDC 2CD	A.23
1123500000	TRS 24VDC 2CD	A.23
1123510000	TRS 48VDC 2CD	A.23
1123520000	TRS 60VDC 2CD	A.23
1123530000	TRS 120VDC 2CD	A.23
1123540000	TRS 230VDC 2CD	A.23
1123550000	TRS 120VAC RC 2CD	A.23
1123570000	TRS 230VAC RC 2CD	A.23
1123580000	TRS 24-230VDC 2CD	A.26
1123590000	TRZ 5VDC 2CD	A.23
1123600000	TRZ 12VDC 2CD	A.23
1123610000	TRZ 24VDC 2CD	A.23
1123620000	TRZ 24VDC 2CD	A.23

Order No.	Type	Page
-----------	------	------

1123630000	TRZ 48VDC 2CD	A.23
1123640000	TRZ 60VDC 2CD	A.23
1123650000	TRZ 120VDC 2CD	A.23
1123670000	TRZ 230VDC 2CD	A.23
1123680000	TRZ 120VAC RC 2CD	A.23
1123690000	TRZ 230VAC RC 2CD	A.23
1123700000	TRZ 24-230VDC 2CD	A.26
1123710000	TRS 5VDC 2CD AU	A.25
1123720000	TRS 12VDC 2CD AU	A.25
1123730000	TRS 24VDC 2CD AU	A.25
1123740000	TRS 24VDC 2CD AU	A.25
1123750000	TRS 48VDC 2CD AU	A.25
1123770000	TRS 60VDC 2CD AU	A.25
1123780000	TRS 120VDC 2CD AU	A.25
1123790000	TRS 230VDC 2CD AU	A.25
1123800000	TRS 120VAC RC 2CD AU	A.25
1123810000	TRS 230VAC RC 2CD AU	A.25
1123820000	TRS 24-230VDC 2CD AU	A.27
1123830000	TRZ 5VDC 2CD AU	A.25
1123840000	TRZ 12VDC 2CD AU	A.25
1123850000	TRZ 24VDC 2CD AU	A.25
1123870000	TRZ 24VDC 2CD AU	A.25
1123880000	TRZ 48VDC 2CD AU	A.25
1123890000	TRZ 60VDC 2CD AU	A.25
1123900000	TRZ 120VDC 2CD AU	A.25
1123910000	TRZ 230VDC 2CD AU	A.25
1123920000	TRZ 120VAC RC 2CD AU	A.25
1123930000	TRZ 230VAC RC 2CD AU	A.25
1123940000	TRZ 24-230VDC 2CD AU	A.27
1123950000	TRS 5VDC 2CD EMPTY	A.50
1123970000	TRS 12VDC 2CD EMPTY	A.50
1123980000	TRS 24VDC 2CD EMPTY	A.50
1123990000	TRS 24VDC 2CD EMPTY	A.50
1124000000	TRS 48VDC 2CD EMPTY	A.50
1124010000	TRS 60VDC 2CD EMPTY	A.50
1124020000	TRS 120VDC 2CD EMPTY	A.50
1124030000	TRS 230VDC 2CD EMPTY	A.50
1124040000	TRS 120VAC RC 2CD EMPTY	A.50
1124050000	TRS 230VAC RC 2CD EMPTY	A.50
1124070000	TRS 24-230VDC 2CD EMPTY	A.50
1124080000	TRZ 5VDC 2CD EMPTY	A.50
1124090000	TRZ 12VDC 2CD EMPTY	A.50
1124100000	TRZ 24VDC 2CD EMPTY	A.50
1124110000	TRZ 24VDC 2CD EMPTY	A.50
1124120000	TRZ 48VDC 2CD EMPTY	A.50
1124130000	TRZ 60VDC 2CD EMPTY	A.50
1124140000	TRZ 120VDC 2CD EMPTY	A.50
1124150000	TRZ 230VDC 2CD EMPTY	A.50
1124170000	TRZ 120VAC RC 2CD EMPTY	A.50
1124180000	TRZ 230VAC RC 2CD EMPTY	A.50
1124190000	TRZ 24-230VDC 2CD EMPTY	A.50
1124200000	TOS 5VDC 48VDC0,1A	A.29
1124210000	TOS 12VDC 48VDC0,1A	A.29
1124220000	TOS 24VDC 48VDC0,1A	A.29
1124230000	TOS 48VDC 48VDC0,1A	A.29
1124240000	TOS 60VDC 48VDC0,1A	A.29
1124250000	TOS 120VDC 48VDC0,1A	A.29
1124260000	TOS 230VDC 48VDC0,1A	A.29
1124270000	TOS 120VAC RC 48VDC0,1A	A.29
1124280000	TOS 230VAC RC 48VDC0,1A	A.29
1124290000	TOS 24-230VDC 48VDC0,1A	A.30
1124300000	TOZ 5VDC 48VDC0,1A	A.29
1124310000	TOZ 12VDC 48VDC0,1A	A.29
1124320000	TOZ 24VDC 48VDC0,1A	A.29
1124330000	TOZ 48VDC 48VDC0,1A	A.29
1124340000	TOZ 60VDC 48VDC0,1A	A.29
1124350000	TOZ 120VDC 48VDC0,1A	A.29
1124360000	TOZ 230VDC 48VDC0,1A	A.29
1124370000	TOZ 120VAC RC 48VDC0,1A	A.29
1124380000	TOZ 230VAC RC 48VDC0,1A	A.29
1124390000	TOZ 24-230VDC 48VDC0,1A	A.30
1124400000	TOS 5VDC 24VDC2A	A.33
1124410000	TOS 12VDC 24VDC2A	A.33
1124420000	TOS 24VDC 24VDC2A	A.33
1124430000	TOS 24VDC 24VDC2A	A.33
1124440000	TOS 48VDC 24VDC2A	A.33
1124450000	TOS 60VDC 24VDC2A	A.33
1124460000	TOS 120VDC 24VDC2A	A.33
1124470000	TOS 230VDC 24VDC2A	A.33
1124480000	TOS 120VAC RC 24VDC2A	A.33
1124490000	TOS 230VAC RC 24VDC2A	A.33
1124500000	TOS 24-230VDC 24VDC2A	A.34
1124510000	TOZ 5VDC 24VDC2A	A.33
1124520000	TOZ 12VDC 24VDC2A	A.33
1124530000	TOZ 24VDC 24VDC2A	A.33
1124540000	TOZ 24VDC 24VDC2A	A.33
1124550000	TOZ 48VDC 24VDC2A	A.33
1124560000	TOZ 60VDC 24VDC2A	A.33
1124570000	TOZ 120VDC 24VDC2A	A.33
1124580000	TOZ 230VDC 24VDC2A	A.33
1124590000	TOZ 120VAC RC 24VDC2A	A.33
1124600000	TOZ 230VAC RC 24VDC2A	A.34
1124610000	TOS 5VDC 230VAC1A	A.37
1124620000	TOS 12VDC 230VAC1A	A.37
1124630000	TOS 24VDC 230VAC1A	A.37
1124640000	TOS 24VDC 230VAC1A	A.37

Order No.	Type	Page
-----------	------	------

1127430000	TOS 48VDC 230VAC1A	A.37
1127440000	TOS 60VDC 230VAC1A	A.37
1127450000	TOS 120VDC 230VAC1A	A.37
1127470000	TOS 230VDC 230VAC1A	A.37
1127480000	TOS 120VAC RC 230VAC1A	A.37
1127490000	TOS 230VAC RC 230VAC1A	A.37
1127500000	TOS 24-230VDC 230VAC1A	A.38
1127510000	TOZ 5VDC 230VAC1A	A.37
1127520000	TOZ 12VDC 230VAC1A	A.37
1127530000	TOZ 24VDC 230VAC1A	A.37
1127540000	TOZ 24VDC 230VAC1A	A.37
1127550000	TOZ 48VDC 230VAC1A	A.37
1127570000	TOZ 60VDC 230VAC1A	A.37
1127580000	TOZ 120VDC 230VAC1A	A.37
1127590000	TOZ 230VDC 230VAC1A	A.37
1127600000	TOZ 120VAC RC 230VAC1A	A.37
1127610000	TOZ 230VAC RC 230VAC1A	A.37
1127620000	TOZ 24-230VDC 230VAC1A	A.38
1127630000	TOS 24VDC 24VDC3,5A	A.40
1127640000	TOS 24-230VDC 24VDC3,5A	A.40
1127650000	TOZ 24VDC 24VDC3,5A	A.40
1127670000	TOZ 24-230VDC 24VDC3,5A	A.40
1127680000	TOS 24VDC 230VAC1A	A.42
1127690000	TOS 24-230VDC 230VAC1A	A.42
1127700000	TOZ 24VDC 230VAC1A	A.42
1127710000	TOZ 24-230VDC 230VAC1A	A.42
1127720000	TOS 24VDC EMPTY	A.50
1127730000	TOS 24-230VDC EMPTY	A.50
1127740000	TOZ 24VDC EMPTY	A.50
1127750000	TOZ 24-230VDC EMPTY	A.50

## 113000000

1132070000	SRCA QV S	B.46
1132070000	SRCA QV S	B.46
1132070000	SRCA QV S	B.50
1132070000	SRCA QV S	B.50
1132080000	SCMH QV S	B.57
1132080000	SCMH QV S	B.60
1132080000	SCMH QV S	B.63
1132080000	SCMH QV S	B.63
1132090000	SRCA CLIP HM RC1	B.46
1132090000	SRCA CLIP HM RC1	B.46
1132090000	SRCA CLIP HM RC1	B.46
1132090000	SRCA CLIP HM RC1	B.50
1132090000	SRCA CLIP HM RC1	B.50
1132090000	SRCA CLIP HM RC1	B.50
1132260000	SSS RELAIS 5V/230V 1AAC	A.49
1132290000	SSR 24VDC/max.240VAC 1A	A.49
1132310000	SSR 24VDC/0-24VDC 3,5A	A.49
1132810000	SRD ECO 2CD	B.36
1132820000	SRD ECO 3CD	B.36
1133360000	DRR270012L	B.33
1133370000	DRR270024L	B.33
1133380000	DRR270048L	B.33
1133390000	DRR270110L	B.33
1133400000	DRR270220L	B.33
1133410000	DRR370012L	B.35
1133420000	DRR370024L	B.35
1133430000	DRR370048L	B.35
1133440000	DRR370110L	B.35
1133450000	DRR37012L	B.13
1133460000	DRR170024L	B.13
1133470000	DRR170048L	B.13
1133480000	DRR170110L	B.13
1133490000	DRR170220L	B.13
1133510000	DRR270012L	B.15
1133520000	DRR270024L	B.15
1133530000	DRR270048L	B.15
1133540000	DRR270110L	B.15
1133550000	DRR270220L	B.15
1133560000	DRR3700220L	B.37
1133570000	DRR370012L	B.15
1133580000	DRR370024L	B.17
1133590000	DRR370048L	B.17
1133600000	DRR370110L	B.17
1133610000	DRR370220L	B.17
1133620000	DRR570012L	B.19
1133630000		

Order No.	Type	Page
-----------	------	------

## 1220000000

1220010000	DRH174548LT	B.25
1220020000	DRH174615LT	B.25
1220030000	DRH174730LT	B.25
1220040000	DRH275012LT	B.27
1220050000	DRH275024LT	B.27
1220060000	DRH275048LT	B.27
1220070000	DRH275110LT	B.27
1220080000	DRH275220LT	B.27
1220090000	DRH275524LT	B.27
1220100000	DRH275548LT	B.27
1220120000	DRH275615LT	B.27
1220130000	DRH275730LT	B.27
1220140000	DRH276012LT	B.29
1220150000	DRH276024LT	B.29
1220170000	DRH276048LT	B.29
1220180000	DRH276110LT	B.29
1220190000	DRH276220LT	B.29
1220200000	DRH276524LT	B.29
1220210000	DRH276548LT	B.29
1220220000	DRH276615LT	B.29
1220230000	DRH276730LT	B.29
1220250000	RELAY SOCKET SPW 3CD	B.30
1220260000	DRW/DRH CLIP M	B.30
1220670000	RSS112012 12VDC-REL1U	A.48

## 1240000000

1240780000	TXS SUPPLY	A.51
1240790000	TXZ SUPPLY	A.51
1240800000	TW TXS/TXZ R3.2	A.51

## 1250000000

1254880000	TOP 24VDC/24VDC 4A	A.65
------------	--------------------	------

## 1270000000

1275100000	TOS 24VDC/24VDC 4A	A.65
------------	--------------------	------

## 1280000000

1283230000	MOS 24VDC/8-30VDC 2A E	A.73
------------	------------------------	------

## 1300000000

1303760000	SCS 24VDC P1SIL3DS M	D.6
1303890000	SCS 24VDC P1SIL3DS	D.6
1304040000	SCS 24VDC P1SIL3DS MG3	D.6

## 1310000000

1319270000	SCS 24VDC P2SIL3DSES	D.7
1319280000	SCS 24VDC P2SIL3ES	D.8

## 1320000000

1323880000	SD TO 0.6X3.0	A.51
------------	---------------	------

## 1380000000

1381900000	TRS 24VDC ACT	A.14
------------	---------------	------

## 1390000000

1390350000	ZQV 1.5N/R6.4/10 BL	A.51
1391600000	ZQV 1.5N/R6.4/19 SW	A.51
1391610000	ZQV 1.5N/R6.4/19 RT	A.51
1391620000	ZQV 1.5N/R6.4/19 BL	A.51
1391630000	ZQV 1.5N/R6.4/10 SW	A.51
1391640000	ZQV 1.5N/R6.4/10 RT	A.51
1391670000	TRZ 24VDC ACT	A.14
1391680000	TOS 24VDC ACT	A.35
1391690000	TOZ 24VDC ACT	A.35

## 1400000000

1406200000	PSSR 24VDC/1PH AC 25A	C.4
1406210000	PSSR 24VDC/1PH AC 35A	C.6
1406220000	PSSR 230VAC/1PH AC 25A	C.5
1406230000	PSSR 1PH CONTROL UNIT	C.7
1406240000	PSSR 24VDC/1PH AC50A HP	C.8
1406250000	PSSR 24VDC/1PH AC75A HP	C.9
1406270000	PSSR 20MA/1PH AC70A PC	C.10

## 1460000000

1463520000	TIA F10	A.52
1463530000	TIA SUBD 15S	A.53
1463540000	TIAL F10	A.54
1463550000	TIAL F20	A.55

## 1470000000

1479650000	TRS 5VDC 1CO 16A	A.17
------------	------------------	------

Order No.	Type	Page
-----------	------	------

1479670000	TRS 12VDC 1CO 16A	A.17
1479680000	TRS 24VDC 1CO 16A	A.17
1479690000	TRS 24VDC 1CO 16A	A.17
1479700000	TRS 48VDC 1CO 16A	A.17
1479710000	TRS 60VDC 1CO 16A	A.17
1479730000	TRS 120VDC 1CO 16A	A.17
1479740000	TRS 230VDC 1CO 16A	A.17
1479750000	TRS 120VAC RC 1CO 16A	A.17
1479760000	TRS 230VAC RC 1CO 16A	A.17
1479770000	TRS 24-230VDC 1CO 16A	A.18
1479780000	TRS 24VDC 1NO HC	A.20
1479790000	TRS 24-230VDC 1NO HC	A.20
1479800000	TRZ 5VDC 1CO 16A	A.17
1479810000	TRS 24VDC 1NO HCP	A.21
1479820000	TRZ 12VDC 1CO 16A	A.17
1479830000	TRS 24-230VDC 1NO HCP	A.21
1479840000	TRZ 24VDC 1CO 16A	A.17
1479850000	TRZ 24VDC 1CO 16A	A.17
1479870000	TRZ 48VDC 1CO 16A	A.17
1479880000	TRZ 60VDC 1CO 16A	A.17
1479890000	TRZ 120VDC 1CO 16A	A.17
1479900000	TRZ 230VDC 1CO 16A	A.17
1479910000	TRZ 120VAC RC 1CO 16A	A.17
1479920000	TRZ 230VAC RC 1CO 16A	A.17
1479930000	TRZ 24-230VDC 1CO 16A	A.18
1479940000	TRZ 24VDC 1NO HC	A.20
1479950000	TRZ 24-230VDC 1NO HC	A.20
1479970000	TRZ 24VDC 1NO HCP	A.21
1479980000	TRZ 24-230VDC 1NO HCP	A.21

## 1600000000

1609900000	WS 12/6 MC NE WS	A.66
1609900000	WS 12/6 MC NE WS	A.78

## 1750000000

1758250000	ZQV 4N/2 GE	A.66
1758250000	ZQV 4N/2 GE	A.78
1758250000	ZQV 4N/2 GE	A.90
1758260000	ZQV 4N/10 GE	A.66
1758260000	ZQV 4N/10 GE	A.78
1758260000	ZQV 4N/10 GE	A.90

## 1760000000

1762620000	ZQV 4N/4 GE	A.66
1762620000	ZQV 4N/4 GE	A.78
1762620000	ZQV 4N/4 GE	A.90
1762630000	ZQV 4N/3 GE	A.66
1762630000	ZQV 4N/3 GE	A.78
1762630000	ZQV 4N/3 GE	A.90

## 1790000000

1793950000	ZQV 4N/2 RT	A.66
1793950000	ZQV 4N/2 RT	A.78
1793950000	ZQV 4N/2 RT	A.90
1793960000	ZQV 4N/2 BL	A.66
1793960000	ZQV 4N/2 BL	A.78
1793960000	ZQV 4N/2 BL	A.90
1793970000	ZQV 4N/2 SW	A.66
1793970000	ZQV 4N/2 SW	A.78
1793970000	ZQV 4N/2 SW	A.90
1793980000	ZQV 4N/3 RT	A.66
1793980000	ZQV 4N/3 RT	A.78
1793980000	ZQV 4N/3 RT	A.90
1793990000	ZQV 4N/3 BL	A.66
1793990000	ZQV 4N/3 BL	A.78
1793990000	ZQV 4N/3 BL	A.90
1794000000	ZQV 4N/3 SW	A.66
1794000000	ZQV 4N/3 SW	A.78
1794000000	ZQV 4N/3 SW	A.90
1794010000	ZQV 4N/4 RT	A.66
1794010000	ZQV 4N/4 RT	A.78
1794010000	ZQV 4N/4 RT	A.90
1794020000	ZQV 4N/4 BL	A.66
1794020000	ZQV 4N/4 BL	A.78
1794020000	ZQV 4N/4 BL	A.90
1794030000	ZQV 4N/4 SW	A.66
1794030000	ZQV 4N/4 SW	A.78
1794030000	ZQV 4N/4 SW	A.90
1794040000	ZQV 4N/10 RT	A.66
1794040000	ZQV 4N/10 RT	A.78
1794040000	ZQV 4N/10 RT	A.90
1794050000	ZQV 4N/10 BL	A.66
1794050000	ZQV 4N/10 BL	A.78
1794050000	ZQV 4N/10 BL	A.90
1794060000	ZQV 4N/10 SW	A.66
1794060000	ZQV 4N/10 SW	A.78
1794060000	ZQV 4N/10 SW	A.90

## 1810000000

1818400000	WS 10/6 MC M NE WS	A.51
------------	--------------------	------

## 1820000000

1828450000	WS 10/6 MC NE WS	A.90
------------	------------------	------

Order No.	Type	Page
-----------	------	------

## 1850000000

1857440000	ESG 9/11 K MC NE WS	B.57
1857440000	ESG 9/11 K MC NE WS	B.57
1857440000	ESG 9/11 K MC NE WS	B.60
1857440000	ESG 9/11 K MC NE WS	B.63
1857440000	ESG 9/11 K MC NE WS	B.63
1857440000	ESG 9/11 K MC NE WS	B.63

## 1880000000

1880100000	ESG 6/15 K MC NE WS	B.46
1880100000	ESG 6/15 K MC NE WS	B.46
1880100000	ESG 6/15 K MC NE WS	B.46
1880100000	ESG 6/15 K MC NE WS	B.50
1880100000	ESG 6/15 K MC NE WS	B.50
1880100000	ESG 6/15 K MC NE WS	B.50

## 1900000000

1909020000	ZQV 4N/20 GE	A.66
1909020000	ZQV 4N/20 GE	A.78
1909020000	ZQV 4N/20 GE	A.90
1909100000	ZQV 4N/20 BL	A.66
1909100000	ZQV 4N/20 BL	A.78
1909100000	ZQV 4N/20 BL	A.90
1909120000	ZQV 4N/20 SW	A.66
1909120000	ZQV 4N/20 SW	A.78
1909120000	ZQV 4N/20 SW	A.90
1909150000	ZQV 4N/20 RT	A.66
1909150000	ZQV 4N/20 RT	A.78
1909150000	ZQV 4N/20 RT	A.90

## 1980000000

1984540000	TRS 24VDC 1CO AGSNO	A.15
1984550000	TRZ 24VDC 1CO AGSNO	A.15
1984560000	TRS 12VDC 1CO C1D2	A.45
1984570000	TRS 24VDC 1CO C1D2	A.45
1984580000	TRS 24VDC 1CO C1D2	A.45
1984590000	TRS 120VACRC 1CO C1D2	A.45
1984600000	TRS 230VACRC 1CO C1D2	A.45
1984610000	TRS 24-230VDC 1CO C1D2	A.45
1984620000	TRS 12VDC 1COAU C1D2	A.47
1984630000	TRS 24VDC 1COAU C1D2	A.47
1984640000	TRS 120VACRC 1COAU C1D2	A.47
1984650000	TRS 24-230VDC 1COAUC1D2	A.47

## 1990000000

1990960000	TOS 24VDC 24VDC5A	A.41
1990970000	TOS 24-230VDC 24VDC5A	A.41
1990980000	TOZ 24VDC 24VDC5A	A.41
1990990000	TOZ 24-230VDC 24VDC5A	A.41

## 4050000000

4058560000	RCL424012	A.48
4058570000	RCL424024	A.48
4058580000	RCL425024	A.48
4058590000	RCL424110	A.48
4058750000	RCL424048	A.48
4058760000	RCL424060	A.48

## 4060000000

4060120000	RSS113024 24VDC-REL1U	A.48
4061180000	SSS RELAIS 24V/24V 0,1ADC	A.49
4061190000	SSS RELAIS 24V/24V 2ADC	A.49
4061200000	SSS RELAIS 60V/24V 2ADC	A.49
4061210000	SSS RELAIS 24V/230V 1AAC	A.49
4061220000	SSS RELAIS 60V/230V 1AAC	A.49
4061230000	SSS RELAIS 60V/24V 0,1ADC	A.49
4061580000	RSS113005 05VDC-REL1U	A.48
4061590000	RSS112024 24VDC-REL1U	A.48
4061600000	RSS112060 60VDC-REL1U	A.48
4061610000	RSS113012 12VDC-REL1U	A.48
4061630000	RSS113060 60VDC-REL1U	A.48
4064310000	SSS RELAIS 5V/24V 2ADC	A.49
4064320000	SSS RELAIS 5V/24V 0,1ADC	A.49

## 4070000000

4074580000	RCL425012	A.48
------------	-----------	------

## 7760000000

7760056014	RIM 3 110/230VAC	B.10
7760056014	RIM 3 110/230VAC	B.20
7760056015	RIM 2 6/24VDC	B.10
7760056016	RIM 2 24/60VDC	B.10
7760056017	RIM 2 110/230VDC	B.10
7760056018	RIM 3 24/60VDC	B.10
7760056045	RIM 3 110/230VAC LED	B.10
7760056050	DRM270012	B.7
7760056051	DRM270024	B.7
7760056052	DRM270048	B.7
7760056053	DRM270110	B.7
7760056054	DRM270220	B.7

||
||
||





Order No.	Type	Page
8881600000	RCIKIT 230VAC 1CO LD/PB	B.44
8881610000	RCIKIT 24VDC 2CO LD/PB	B.48
8881620000	RCIKIT 24VAC 2CO LD/PB	B.48
8881630000	RCIKIT 230VAC 2CO LD/PB	B.48

## 8890000000

8897060000	RCIKIT 115VAC 1CO LD/PB	B.44
8897080000	RCIKIT 115VAC 2CO LD/PB	B.48
8897090000	RCIKIT 115VAC 1CO LD	B.44
8897100000	RCIKIT 115VAC 2CO LD	B.48
8897110000	RCIKITP 24VDC 1CO LD	B.45
8897120000	RCIKITP 24VAC 1CO LD	B.45
8897130000	RCIKITP 115VAC 1CO LD	B.45
8897140000	RCIKITP 230VAC 1CO LD	B.45
8897150000	RCIKITP 24VDC 2CO LD	B.49
8897160000	RCIKITP 24VAC 2CO LD	B.49
8897170000	RCIKITP 115VAC 2CO LD	B.49
8897180000	RCIKITP 230VAC 2CO LD	B.49
8897190000	RCIKITP 24VDC 1CO LD/PB	B.45
8897200000	RCIKITP 24VAC 1CO LD/PB	B.45
8897210000	RCIKITP115VAC 1CO LD/PB	B.45
8897220000	RCIKITP230VAC 1CO LD/PB	B.45
8897230000	RCIKITP 24VDC 2CO LD/PB	B.49
8897240000	RCIKITP 24VAC 2CO LD/PB	B.49
8897250000	RCIKITP115VAC 2CO LD/PB	B.49
8897260000	RCIKITP230VAC 2CO LD/PB	B.49

## 8920000000

8920940000	RCMKIT1 24VDC 2CO LD	B.56
8920950000	RCMKIT1 24VAC 2CO LD	B.56
8920960000	RCMKIT1 115VAC 2CO LD	B.56
8920970000	RCMKIT1 230VAC 2CO LD	B.56
8920980000	RCMKIT1 24VDC 3CO LD	B.59
8920990000	RCMKIT1 24VAC 3CO LD	B.59
8921010000	RCMKIT1 115VAC 3CO LD	B.59
8921020000	RCMKIT1 230VAC 3CO LD	B.59
8921030000	RCMKIT1 24VDC 4CO LD	B.62
8921040000	RCMKIT1 24VAC 4CO LD	B.62
8921050000	RCMKIT1 115VAC 4CO LD	B.62
8921060000	RCMKIT1 230VAC 4CO LD	B.62
8921080000	RCMKITP1 24VDC 2CO LD	B.56
8921090000	RCMKITP1 24VAC 2CO LD	B.56
8921100000	RCMKITP1 115VAC 2CO LD	B.56
8921110000	RCMKITP1 230VAC 2CO LD	B.56
8921120000	RCMKITP1 24VDC 4CO LD	B.62
8921130000	RCMKITP1 24VAC 4CO LD	B.62
8921140000	RCMKITP1 115VAC 4CO LD	B.62
8921150000	RCMKITP1 230VAC 4CO LD	B.62

## 8930000000

8937830000	MOS 24VDC/12-300VDC 1A	A.71
8937920000	MOS 5V TTL/24VDC 0,1A	A.76
8937930000	MOS 12-28VDC/5V TTL	A.77
8937940000	MOS 24VDC/5-33VDC 10A	A.70
8937970000	MOS 24VDC/8-30VDC 2A	A.72
8937980000	MOS 24VDC/5-48VDC 0,5A	A.74
8937990000	MOS 12-28VDC 100kHz	A.75

## 8950000000

8950700000	TOS 5VDC/48VDC 0,1A	A.59
8950710000	TOS 12VDC/48VDC 0,1A	A.59
8950720000	TOS 24VDC/48VDC 0,1A	A.59
8950730000	TOS 48-60VDC/48VDC 0,1A	A.59
8950740000	TOS 110VDC/48VDC 0,1A	A.59
8950750000	TOS 220VDC/48VDC 0,1A	A.59
8950760000	TOP 5VDC/48VDC 0,1A	A.59
8950770000	TOP 12VDC/48VDC 0,1A	A.59
8950780000	TOP 24VDC/48VDC 0,1A	A.59
8950790000	TOP 48-60VDC/48VDC 0,1A	A.59
8950800000	TOP 110VDC/48VDC 0,1A	A.59
8950810000	TOP 220VDC/48VDC 0,1A	A.59
8950820000	TOS 24VAC/48VDC 0,1A	A.59
8950830000	TOS 48-60VAC/48VDC 0,1A	A.59
8950840000	TOS 120VAC/48VDC 0,1A	A.59
8950850000	TOS 230VAC/48VDC 0,1A	A.59
8950860000	TOP 24VAC/48VDC 0,1A	A.59
8950870000	TOP 48-60VAC/48VDC 0,1A	A.59
8950880000	TOP 120VAC/48VDC 0,1A	A.59
8950890000	TOP 230VAC/48VDC 0,1A	A.59
8950900000	TOS 5VDC/48VDC 0,5A	A.61
8950910000	TOS 12VDC/48VDC 0,5A	A.61
8950920000	TOS 24VDC/48VDC 0,5A	A.61
8950930000	TOS 48-60VDC/48VDC 0,5A	A.61
8950940000	TOS 110VDC/48VDC 0,5A	A.61
8950950000	TOS 220VDC/48VDC 0,5A	A.61
8950960000	TOP 5VDC/48VDC 0,5A	A.61
8950970000	TOP 12VDC/48VDC 0,5A	A.61
8950980000	TOP 24VDC/48VDC 0,5A	A.61
8950990000	TOP 48-60VDC/48VDC 0,5A	A.61
8951000000	TOP 110VDC/48VDC 0,5A	A.61
8951010000	TOP 220VDC/48VDC 0,5A	A.61
8951020000	TOS 24VAC/48VDC 0,5A	A.61
8951030000	TOS 48-60VAC/48VDC 0,5A	A.61
8951040000	TOS 120VAC/48VDC 0,5A	A.61
8951050000	TOS 230VAC/48VDC 0,5A	A.61

Order No.	Type	Page
8951060000	TOP 24VAC/48VDC 0,5A	A.61
8951070000	TOP 48-60VAC/48VDC 0,5A	A.61
8951080000	TOP 120VAC/48VDC 0,5A	A.61
8951090000	TOP 230VAC/48VDC 0,5A	A.61
8951100000	TOS 5VDC/230VAC 0,1A	A.63
8951110000	TOS 12VDC/230VAC 0,1A	A.63
8951120000	TOS 24VDC/230VAC 0,1A	A.63
8951130000	TOS 48-60VDC/230VAC 0,1A	A.63
8951140000	TOS 110VDC/230VAC 0,1A	A.63
8951150000	TOS 220VDC/230VAC 0,1A	A.63
8951160000	TOP 5VDC/230VAC 0,1A	A.63
8951170000	TOP 12VDC/230VAC 0,1A	A.63
8951180000	TOP 24VDC/230VAC 0,1A	A.63
8951190000	TOP 48-60VDC/230VAC 0,1A	A.63
8951200000	TOP 110VDC/230VAC 0,1A	A.63
8951210000	TOP 220VDC/230VAC 0,1A	A.63
8951220000	TOS 24VAC/230VAC 0,1A	A.63
8951230000	TOS 48-60VAC/230VAC 0,1A	A.63
8951240000	TOS 120VAC/230VAC 0,1A	A.63
8951250000	TOS 230VAC/230VAC 0,1A	A.63
8951260000	TOP 24VAC/230VAC 0,1A	A.63
8951270000	TOP 48-60VAC/230VAC 0,1A	A.63
8951280000	TOP 120VAC/230VAC 0,1A	A.63
8951290000	TOP 230VAC/230VAC 0,1A	A.63
8952130000	PSSR 24VDC/3PH AC 20A	C.12
8952140000	PSSR 230VDC/3PH AC 20A	C.13
8957020000	RCM270AB2	B.67
8957030000	RCM270AC4	B.67
8957090000	RCM370AB2	B.69
8957100000	RCM370AC4	B.69
8957120000	RCM370BB0	B.69
8957160000	RCM570AB2	B.71
8957170000	RCM570AC4	B.71
8957180000	RCM570AE8	B.71
8957190000	RCM570BB0	B.71

## 8970000000

8973450000	MOS FEED THROUGH	A.78
8973460000	MOS SUPPLY	A.78

## 9000000000

9008320000	SDS 0.5X3.0X80	C.14
9008330000	SDS 0.6X3.5X100	A.51
9008330000	SDS 0.6X3.5X100	A.66
9008330000	SDS 0.6X3.5X100	A.78
9008330000	SDS 0.6X3.5X100	A.90
9008470000	SDK PH0	A.51
9008540000	SDK PZ2	C.14



# Addresses worldwide

## Let's connect.

### AE United Arab Emirates

Weidmüller Middle East FZE  
Warehouse Q3-79  
SAIF-Zone  
P.O. BOX 8591  
Sharjah  
Tel. +971 65572723  
Fax +971 65572724  
wme.info@weidmueller.com

### AO Angola

Please contact  
Phambili Interface  
South Africa

### AR Argentina

CPI SA  
Bauness 2660  
C1431DOF Buenos Aires  
Tel. +54 11 4523 8008  
Fax +54 11 4522 0546  
info@cpi.com.ar  
www.cpi.com.ar

### AT Austria

Weidmüller GmbH  
IZ NOE Süd Straße 2b, Obj  
M 59  
2355 Wiener Neudorf  
Tel. +43 2236 67080  
Fax +43 2236 6708-899  
office.at@weidmueller.com  
www.weidmueller.com

### AU Australia

Weidmüller Pty. Ltd.  
PO BOX 6944  
Huntingwood 2148  
Huntingwood Drive 43  
Huntingwood NSW 2148  
Tel. +61 2 9671 9999  
Fax +61 2 9671 9911  
info@weidmuller.com.au  
www.weidmuller.com.au

### AZ Azerbaijan

Representative Office  
Rashad Mahmudov  
Demirchi Tower, 4th floor  
37, Khojali ave.  
AZ 1025 Baku  
Tel. +994 12 488 80 36  
Fax +994 12 488 80 37  
rashad.mahmudov@  
weidmueller.com

### BA Bosnia and Herzegovina

Please contact  
our Representative Office  
Weidmüller Interface GmbH  
& Co. KG  
Serbia

or

BIG electric d.o.o  
Mladena Stojanovića 117A  
78000 Banja Luka  
Tel. +387 51926277  
Fax +387 51926277  
bigelectric@blic.net  
www.bigelectric.ba

### BE Belgium

Weidmüller Benelux B. V.  
Mechelsesteenweg 519 bus  
6 en 7  
1930 Nossegem  
Tel. +32 2 752 40 70  
Fax +32 2 751 36 06  
info@weidmueller.be  
www.weidmueller.be

### BG Bulgaria

Weid-Bul EOOD  
Bul. „Kliment Ohridski“ 13  
1756 Sofia  
Tel. +359 2 963 2560  
Fax +359 2 963 1098  
sofia@weidbul.com  
www.weidbul.com

### BH Bahrain

Khayber Trading Company  
P.O Box 1976  
Manama  
Tel. +973 720747  
Fax +973 720331  
khayber@batelco.com.bh

### BR Brazil

Weidmüller Conexel do Brasil  
Conexões Elétricas Ltda.  
Av. Presidente Juscelino, 642  
- Piraporinha  
Diadema, São Paulo  
09950-370  
Tel. +55 (11) 4366-9600  
Fax +55 (11) 4362-1677  
vendas@weidmueller.com.br  
www.weidmueller.com.br

### BW Botswana

Please contact  
Phambili Interface  
South Africa

### BY Belarus

TECHNIKON Ltd.  
Nezavisimosti pr. 177-9  
220125 Minsk  
Tel. +375 17 393-11-77  
Fax +375 17 3930080  
wm@technikon.by

### CA Canada

W Interconnections Canada  
Inc.  
10 Spy Court  
Markham Ontario L3R 5H6  
Tel. +1 (905) 475-1507  
Ext. 9836  
Fax +1 (905) 475-2798  
support@weidmuller.ca  
www.weidmuller.ca

### CG Congo

Please contact  
Phambili Interface  
South Africa

### CH Switzerland

Weidmüller Schweiz AG  
Rundbuckstraße 2  
8212 Neuhausen am  
Rheinfall SH  
Tel. +41 52 674 07 07  
Fax +41 52 674 07 08  
info@weidmueller.ch  
www.weidmueller.ch

### CL Chile

ATS-INTECH  
Maria Luisa Santander 0475  
Santiago  
Providencia 7500859  
Tel. +56 2 341 1271  
Fax +56 2 341 1275  
felipe@atsintech.com  
www.atsintech.com  
CPI CHILE LTDA  
Av. Presidente Frei Montalva  
6001, 47 complejo el cortijo  
Santiago - Conchalí  
Tel. +562 963 8440  
Fax +562 963 8440  
cpi@cpichile.cl  
www.cpicichile.cl

### CN China

Weidmüller Interface  
(Shanghai) Co. Ltd.  
100 Yutong Road  
25 F, BM Intercontinental  
Business Center  
200070 Shanghai  
Tel. +86 21-22195008  
Fax +86 512-68417505  
customer.hotline@  
weidmueller.com.cn  
www.weidmueller.com.cn

### CO Colombia

Automatización Avanzada  
S. A.  
Carrera 97 No., 24 c- 23  
Bodega 4  
110911 Bogotá-D.C.  
Tel. +57 (1) 547-8510  
Fax +57 (1) 422-3044  
comercial@  
automatizacionavanzada.com  
www.  
automatizacionavanzada.com

### CR Costa Rica

ELVATRON S. A.  
la Uruca 400 Norte Banco  
Costa Rica  
San Jose Costa Rica  
Tel. +506 2961-060  
Fax +506 5200-609  
dirk.haase@elvatron.com  
www.elvatron.com

### CZ Czech Republic

Weidmüller s.r.o.  
Lomnického 5/1705  
140 00 Praha 4  
Tel. +420 244 001 400  
Fax +420 244 001 499  
office@weidmueller.cz  
www.weidmueller.cz

### DE Germany

Weidmüller GmbH & Co. KG  
Ohmstraße 9  
32758 Detmold  
Postfach 30 54  
32720 Detmold  
Tel. +49 5231 1428-0  
Fax +49 5231 14-292083  
weidmueller@weidmueller.de  
www.weidmueller.de

### DK Denmark

Weidmüller Danmark  
Vallensbækvej 18A  
2605 Brøndby  
Tel. +45 27747800  
kundeservice@weidmuller.dk  
www.weidmuller.dk

### EC Ecuador

Elsystec S. A., Electricidad  
Sistemas y Tecnología  
Vasco de Contreras N35-25 1  
y Mañosca  
Quito - Pichincha  
Tel. +593 22456510  
Fax +593 22456755  
Elsystec@uio.satnet.net

### EE Estonia

Please contact  
our Representative Office  
Weidmüller Interface GmbH  
& Co. KG  
Latvia

or

Soots Interface OÜ  
Pärnu mnt 142  
11317 Tallinn  
Tel. +372 609 6933  
Fax  
info@sootsinterface.ee  
www.sootsinterface.ee

### EG Egypt

Standard Electric (OMEGA)  
1, Abdelhamid Badavy Street  
Heliopolis  
Cairo  
Tel. +202 21805111  
Fax +202 21805600  
stdelec@rite.com

### ES Spain

Weidmüller, S. A.  
Narcis Monturiol 11-13, Pol.  
Ind. Sudoeste  
8960 Sant Just  
Desvern - Barcelona  
Tel. +34 934 803 386  
Fax +34 933 718 055  
weidmuller@weidmuller.es  
www.weidmuller.es

### FI Finland

Weidmüller Suomi,  
Weidmüller Aktiebolagetin  
sivulike  
Koy Plaza Vivace  
Äyrityt 6C  
FI 1510 Vantaa  
Tel. +358 20 7351300  
Fax +358 800 114 667  
asiakaspalvelu@weidmuller.fi  
www.weidmuller.fi

### FR France

Weidmüller E. U. R. L.  
12, Chaussée Jules César  
BP 263 Osny  
95623 Cergy-Pontoise Cedex  
Tel. +33 1 34 24 65 00  
Fax +33 1 34 24 65 01  
mail@weidmuller.fr

### GB Great Britain

Weidmüller Ltd.  
Klippon House  
Centurion Court Office Park,  
Meridian East, Meridian  
Business Park  
Leicester  
LE19 1TP  
Tel. +44 116 282 3470  
Fax +44 116 289 3582  
marketing@weidmuller.co.uk  
www.weidmuller.co.uk

### GE Georgia

Please contact  
our Representative Office  
Rashad Mahmudov  
Azerbaijan.

### GH Ghana

Please contact  
Weidmüller Interface GmbH  
& Co. KG  
South Africa

### GR Greece

G.A. Solutions  
Ippokratous 11 Metamorfois  
144 52 Athen  
Tel. +30 210 2823233  
Fax +30 210 2823233  
info@weidmuller.gr  
www.weidmuller.gr

### GT Guatemala

Prestelectro, Prestegard  
Electro, S.A.  
Avenida Petapa 44-22,  
Zona 12  
Guatemala City  
Tel. +502 2442-3346  
Fax +502 2476-8945  
ventas@prestelectro.com

### HK Hong Kong

Weidmüller (Hong Kong)  
Limited Co. Ltd.  
Unit 1617, Metropolis Tower  
No. 10 Metropolis Drive,  
Hung Hom, Kowloon  
Tel. +852 3154 8088  
Fax +852 31548099  
Info-hk@weidmueller.com.hk

### HR Croatia

ElektroPARTNER d.o.o.  
Slavonska avenija 24/6  
HR-10000 Zagreb  
Tel. +385 (1) 6184 793  
Fax +385 (1) 6184 795  
elektropartner@zg-t-com.hr  
www.elektropartner.hr

### HU Hungary

Weidmüller Kereskedelmi Kft.  
Budapest  
Gubacsi út 6.  
1097  
Tel. +36 1 382 7700  
Fax +36 1 382 7701  
info@weidmueller.hu  
www.weidmueller.hu

### ID Indonesia

PT. Nego Electrindo  
Ruko Mega Grosir Cempaka  
Mas Blok I No. 20 - 22  
Jakarta 10640  
Tel. +62 21 42882255  
Fax +62 21 42882266  
sales@negoelectrindo.co.id

### IE Ireland

Please contact  
Weidmüller Ltd.  
Great Britain

### IL Israel

A. U. Shay Ltd.  
23/25, Embar Street  
49222 Petach-Tikva  
P.O. Box 1 00 49  
49222 Petach-Tikva  
Tel. +972 3-923-3601  
Fax +972 3-923-4601  
shay@uriel-shay.com  
www.uriel-shay.com

### ATEKA Ltd.

4, Ha Tavor lane Industrial  
area Segula  
49691 Petach-Tikva  
P.O. Box 4710  
Petach-Tikva  
Tel. +972 73-200-1311  
Fax +972 3-924 4245  
marketing@ateka.co.il  
www.ateka.co.il

### IN India

Representative Office  
Weidmüller Electronics India  
Pvt. Ltd.  
12th Lane North Avenue, Opp  
Joggers Park,  
Kalyani Nagar, Pune  
411 006  
Tel. +91 20-41290090  
wmi.pune@weidmueller.in  
www.weidmueller.com

### IS Iceland

Samey Automation Center  
Lyngas 13  
210 Garabaer  
Tel. +354 510 5200  
Fax +354 510 5201  
Samey@samey.is  
www.samey.is

### IT Italy

Weidmüller S. r.l.  
Via Albert Einstein 4  
20092 Cinisello  
Balsamo Milano  
Tel. +39 02 660681  
Fax +39 02 6124945  
weidmuller@weidmuller.it  
www.weidmuller.it

### JM Jamaica

Please contact  
W Interconnections Inc.  
United States

### JO Jordan

Trans Jordan for Electro  
PO Box 33 06 07  
Amman  
Tel. +962 6 533 2020  
Fax +962 6 533 5800  
transjordan@batelco.jo

### JP Japan

Nihon Weidmüller Co. Ltd.  
Sphere Tower Tennoz 2-2-8  
Higashi-Shinagawa,  
Shinagawa-ku  
Tokyo  
140-0002  
Tel. +81 3 6711 5300  
Fax +81 3 6711 5333  
weidmullerjapan@weidmuller.  
co.jp  
www.weidmuller.co.jp

### KE Kenya

Please contact  
Phambili Interface  
South Africa

### KR Korea

Weidmüller Korea Co. Ltd.  
9th floor, Wonbang B/D  
Samseong 2-Dong, Gangnam-Gu  
Seoul 143-42  
Tel. +82 2-516-0003  
Fax +82 2-516-0090  
info@weidmuller.co.kr  
www.weidmuller.co.kr

### KZ Kazakhstan

Please contact  
OOO Weidmüller  
Russia

### LT Lithuania

Please contact  
our Representative Office  
Weidmüller Interface GmbH  
& Co. KG  
Latvia

or

ELEKTROS IRANGA  
Tinklų g. 29 a  
LT-5319 Panevėžys  
Tel. +370 (45) 582 828  
Fax  
info@eliranga.lt

### LU Luxembourg

Please contact  
Weidmüller Benelux B. V.  
Netherlands

### LV Latvia



SIA Abi4  
Daugavgrivas 31b  
Rīga, LV-1007  
Tel. +371 674 70999  
Fax +371 674 65637  
abi\_4@tvnet.lv

Representative Office  
Weidmüller Interface GmbH  
& Co. KG  
Udens str. 12-118  
Rīga, LV-1007  
Tel. +371 29254766  
Fax +371 674 65637  
Ilgonis.rudaks@weidmueller.  
com  
www.weidmueller.com



You can find all Weidmüller addresses and your local contact on the internet at: [www.weidmuller.com/countries](http://www.weidmuller.com/countries)

Let's connect.

Sales company   
 Representation abroad   
 without representation abroad 

- MD** **Moldova**  
BERHORD A & D srl  
79/1, str. Milescu Spartaru  
MD-2075 Chisinau  
Moldova  
Tel. +373 (22) 815002  
Fax +373 (22) 815007  
atiuleanu@berhord.com  
www.ad.berhord.com
- ME** **Montenegro**  
Please contact  
our Representative Office  
Weidmüller Interface GmbH  
& Co. KG  
Serbia.
- MG** **Madagascar**  
Please contact  
Phambili Interface  
South Africa
- MK** **Macedonia**  
Please contact  
our Representative Office  
Weidmüller Interface GmbH  
& Co. KG  
Serbia  
  
or  
ELEKTRO - SMK doel  
UL. III Makedonska brigada  
b.b.  
1000 Skopje  
Tel. +389 22460295  
Fax  
Elektro-smk@telekabel.net.mk
- MT** **Malta**  
E. S. S., Electrical Supplies &  
Services Ltd.  
San Gwakkim Road  
Mriehel  
  
Tel. +356 2 1255777  
Fax +356 2 1255999  
robert.agius@ess.com.mt
- MU** **Mauritius**  
Mubelo Electrical Ltd.  
Office 26, Gateway building,  
St Jean Road  
Quatre Bornes  
Mauritius  
Tel. +230 4670989  
Fax +230 4654051  
richard.mubelo@orange.mu
- MW** **Malawi**  
Please contact  
Phambili Interface  
South Africa
- MX** **Mexico**  
W Interconnections S. A.  
DE C. V.  
Blvd. Hermanos Serdán 698,  
Col. San Rafael Oriente  
72029 Puebla  
Tel. +52 (222) 268 6227  
Fax +52 (222) 286 6242  
clientes@weidmuller.com.mx
- MY** **Malaysia**  
Connect Plus Technology  
Sdn Bhd  
No. 43, Jalan PJS 11/22,  
Bandar Sunway  
46150 Petaling Jaya  
Selangor Darul Ehsan  
Tel. +60 3 5633 7363  
Fax +60 3 5633 6562  
paul@cptech.com.my  
www.cptech.com.my
- MZ** **Mozambique**  
Please contact  
Phambili Interface  
South Africa
- NA** **Namibia**  
Please contact  
Phambili Interface  
South Africa
- NG** **Nigeria**  
Please contact  
Weidmüller Interface GmbH  
& Co. KG  
South Africa
- NL** **Netherlands**  
Weidmüller Benelux B. V.  
Franciscusweg 221  
1216 SE Hilversum  
P.O. Box 1505  
1200 BM Hilversum  
Tel. +31 35 626 12 61  
Fax +31 35 623 20 44  
info@weidmuller.nl  
www.weidmuller.nl
- NO** **Norway**  
Sivilingeniør J.F. Knudtzen AS  
Billingstadsletta 97  
1396 Billingstad  
PO Box 160  
1378 Nesbru  
Tel. +47 66 98 33 50  
Fax +47 66 98 09 65  
firmapost@jfknudtzen.no  
www.jfknudtzen.no
- NZ** **New Zealand**  
Cuthbert S. Steward Ltd.  
27 Te Puni Street  
Petone  
PO Box 38496  
Wellington Mail Centre 5054  
Tel. (04) 568 6156  
Fax (09) 489 1752  
csl@cuthbertsteward.co.nz  
  
Cuthbert S. Steward Ltd  
4 Fred Thomas Drive  
Aon Building, Ground Floor,  
South Entry  
Takapuna  
PO Box 100 338  
North Shore City 745  
Tel. (09) 489 1751  
Fax (04) 568 6056  
cslak@cuthbertstewart.co.nz
- OM** **Oman**  
DAN INTERNATIONAL LLC.  
Ghala St. 111  
BP 2901  
Seeb  
Tel. +968 5036 77  
Fax +968 5037 55  
yed@danintl.com
- PE** **Peru**  
IMPEXINCA S.A.C.  
Calle Ortiz de Zavallos No.  
105, Urb. San Antonio  
18  
Lima, Miraflores  
Tel. +51 1 447 5608  
info@impexinca.pe  
www.impexinca.pe  
  
J & W CIA. S. A.  
Calle 6 Mz. D Lte. 23, Urb.  
Ind. Grimanesa  
01  
Callao  
Tel. +51 1 572 2539  
Fax +51 1 572 0152  
contacto@jwcia.com  
www.jwcia.com
- PH** **Philippines**  
Enclosure Systems Specialists  
Inc.  
2276 Don Chino Roces  
Avenue Extension  
Room 103/105 Narra Building  
1231 Makati City  
Tel. +63 2 813 8580  
Fax +63 2 813 8596  
sales\_encsys@pltdtdsl.net  
www.enclosuresystemsph.com
- PK** **Pakistan**  
Automation Controls (Pak)  
Apartment No. 33 C III,  
Chenab Block, Allama Iqbal  
Town  
Lahore  
Tel. +92 42 37809948  
Fax +92 42 37809950  
nadeem@acpak.com.pk  
www.acpak.com.pk
- PL** **Poland**  
Weidmüller Sp. z o. o.  
ul. Ogrodowa 58  
00-876 Warszawa  
Tel. +48 22 510 09 40  
Fax +48 22 510 09 41  
biuro@weidmuller.com.pl  
www.weidmuller.pl
- PR** **Puerto Rico**  
Please contact  
W Interconnections Inc.  
United States
- PT** **Portugal**  
Weidmüller Sistemas de  
Interface S. A.  
Estrada Outeiro Polima, R.  
Augusto Dias da Silva, Lote  
B - Esc. 2  
São Domingos de Rana  
2785-515 Abóboda  
Tel. +351 214 459 191  
Fax +351 214 455 871  
weidmuller@weidmuller.pt  
www.weidmuller.pt
- PY** **Paraguay**  
Please contact  
CPI SA  
Argentina
- RO** **Romania**  
Representative Office  
Weidmüller Interface GmbH  
& Co. KG  
Ionescu Crum Street, No.  
1, 1st Tower, 1st Floor,  
Office 4  
500446 Brasov - Brasov  
Business Park  
Tel. +40 (268) 446 222  
Fax +40 (262) 205 410  
claudiu.totea@weidmueller.com  
www.weidmueller.com
- RS** **Serbia**  
Representative Office  
Weidmüller Interface GmbH  
& Co. KG  
Ustanicka 189, III sprat  
lokal 7a  
11050 Beograd  
Tel. +381 112885274  
Fax +381 112885274  
zoran.rabrenovic@  
weidmueller.com
- RU** **Russia**  
OOO Weidmüller  
7/10 Khlebozavodskiy  
Passage,  
Moskau  
115230  
Tel. +7 (495) 771-69-40  
Fax +7 (495) 771-69-41  
Info@weidmuller.ru  
www.weidmueller.ru
- SA** **Saudi Arabia**  
Please contact  
Weidmüller Middle East FZE  
United Arab Emirates
- SE** **Sweden**  
Weidmüller AB  
Axel Danielssons väg 271  
BOX 31025  
SE-200 49 Malmö  
Tel. +46 77-143 00 44  
Fax +46 40-37 48 60  
info@weidmuller.se  
www.weidmuller.se
- SG** **Singapore**  
Weidmüller Pte. Ltd.  
70 Bendemeer Road  
# 04-03 Luzerner Building  
Singapore 339940  
Tel. +65 6841 5311  
Fax +65 6841 5377  
info@weidmuller.com.sg  
www.weidmuller.com.sg
- SI** **Slovenia**  
Elektrospoji d. o. o.  
Stegne 27  
SI- 1000 Ljubljana  
Osrednjėslovenska  
Tel. +386 1 511 3810  
Fax +386 1 511 1604  
info@elektrospoji.si  
www.elektrospoji.si
- SK** **Slovakia**  
ELEKTRIS s.r.o.  
Elektrárėnská 1  
831 04 Bratislava  
Tel. +421 2/4920 0113  
Fax +421 2/4920 0119  
bratislava@elektris.sk
- SV** **El Salvador**  
Prestegard Electro  
11 Avenida Norte No. 240  
Edificio Salazar No. 2  
San Salvador  
Tel. +503 2271 1690  
Fax +503 2221 3851  
prestegard@navigante.com.sv
- SY** **Syria**  
Please contact  
Weidmüller Middle East FZE  
United Arab Emirates
- SZ** **Swaziland**  
Please contact  
Phambili Interface  
South Africa
- TH** **Thailand**  
Pisanu Engineering Co. Ltd.  
Kwang Dingaeng, Khet  
Dingaeng  
800/2 Soi Trakulsuk, Asoke-  
dindaeng Road  
Dindaeng, Bangkok  
10400  
Tel. +66 2 248 2896  
Fax +662 105 6301  
ecsales@pisanu.co.th  
www.pisanu.co.th  
  
Representative Office  
Weidmüller Pte. Ltd.  
37/F, Sathorn Square Building  
98 North Sathorn Road  
Bangkok, Silom Bangrak  
10500  
Tel. +66 2 105 6300  
Fax +66 2 642 9220  
info@weidmuller.com.sg
- TN** **Tunisia**  
Please contact  
Weidmüller E. U. R. L.  
France
- TR** **Turkey**  
Weidmüller Elektronik Ticaret  
Ltd. Sirketi  
Kavacik Mah. Orhan Veli Kanik  
Caddesi 9/1  
34810 Beykoz / Istanbul  
Tel. +90 (216) 537 10 70  
Fax +90 (216) 537 10 77  
info@weidmuller.com.tr  
www.weidmuller.com.tr
- TW** **Taiwan**  
Weidmüller (Hong Kong)  
Limited  
No. 3, Lane 89, ChungYang  
N. Rd  
24148 SanChuang City,  
Taipei  
Tel. +886 921 949 751  
roy.lin@weidmueller.com.hk
- TZ** **Tanzania**  
Please contact  
Phambili Interface  
South Africa
- UA** **Ukraine**  
LLC WM UKRAINE  
Levanevskogo str. 6  
Kiev  
3058  
Tel. +38 044 490 32 48  
Fax  
info@wm-ua.com.ua  
wm-ua.com.ua/  
  
Representative Office  
Weidmüller Interface GmbH  
& Co. KG  
Z, office 303  
7-D, Zdolbunivska str.  
Kiev, 2081  
Mobile +38 050 440 25 24  
info.ua@weidmueller.com
- US** **United States**  
W Interconnections Inc.  
821 Southlake Boulevard  
Richmond Virginia 23236  
Tel. +1 (804) 794-2877  
Fax +1 (804) 379-2593  
info@weidmuller.com  
www.weidmuller.com
- UZ** **Republic of Uzbekistan**  
Please contact  
OOO Weidmüller  
Russia
- VN** **Vietnam**  
AUMI Industrial Equipment &  
Automation Company Limited  
E1, La Thanh Hotel  
218 Doi Can Street  
Lieu Giai Ward, Ba Dinh  
District  
Hanoi City  
Tel. +84 4 37628601  
Fax +84 4 62661391  
aumi@aumi.com.vn  
www.aumi.com.vn  
  
Representative Office  
Weidmüller Pte. Ltd.  
Level 16 Saigon Tower  
Building  
29 Le Duan Street  
District 1  
Ho Chi Minh  
Tel. +848 3520 7717  
Fax +848 3520 7604  
info@weidmuller.com.sg
- ZA** **South Africa**  
Phambili Interface  
PO Box 193  
1609 Johannesburg, Edenvale  
5 Bundo Road, Sebenza  
1610 Johannesburg  
Tel. +27 (11) 4521930  
Fax  
info@weidmuller.co.za  
www.weidmuller.co.za  
  
Representative Office  
Weidmüller Interface GmbH  
& Co. KG  
210 Amarand  
Avenue, Pegasus Building  
181 Pretoria, waterkloof Glen  
ext 2 -  
Tel. +27 12 003 2906  
Fax +27 (11) 4526455  
Jacques.Vosloo@weidmueller.com  
www.weidmueller.com
- ZM** **Zambia**  
Please contact  
Phambili Interface  
South Africa
- ZW** **Zimbabwe**  
Please contact  
Phambili Interface  
South Africa

We cannot guarantee that there are no mistakes in the publications or software provided by us to the customer for the purpose of making orders. We try our best to quickly correct errors in our printed media.

**X**

All orders are based on our general terms of delivery, which can be reviewed on the websites of our group companies where you place your order. On demand we can also send the general terms of delivery to you.



## **Weidmüller – Your partner in Industrial Connectivity**

As experienced experts we support our customers and partners around the world with products, solutions and services in the industrial environment of power, signal and data. We are at home in their industries and markets and know the technological challenges of tomorrow. We are therefore continuously developing innovative, sustainable and useful solutions for their individual needs. Together we set standards in Industrial Connectivity.

Weidmüller Interface GmbH & Co. KG  
Klingenbergstraße 16  
32758 Detmold, Germany  
T +49 5231 14-0  
F +49 5231 14-292083  
info@weidmueller.com  
www.weidmueller.com

Your local Weidmüller partner can  
be found on our website:  
[www.weidmueller.com/countries](http://www.weidmueller.com/countries)

Made in Germany



Order number: 2021220000/06/2015/SMKW