

Darlington 2SD2643

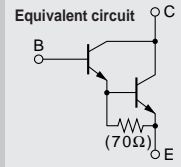

Silicon NPN Triple Diffused Planar Transistor (Complement to type 2SB1687)

Application : Audio, Series Regulator and General Purpose

Absolute maximum ratings (Ta=25°C)

Symbol	Ratings	Unit
V _{CB0}	110	V
V _{CE0}	110	V
V _{EB0}	5	V
I _C	6	A
I _B	1	A
P _C	60(T _C =25°C)	W
T _J	150	°C
T _{stg}	-55 to +150	°C

Electrical Characteristics (Ta=25°C)

Symbol	Conditions	Ratings	Unit
I _{CB0}	V _{CB} =110V	100max	μA
I _{EB0}	V _{EB} =5V	100max	μA
V(BR)CEO	I _C =30mA	110min	V
h _{FE}	V _{CE} =4V, I _C =5A	5000min*	
V _{CE(sat)}	I _C =5A, I _B =5mA	2.5max	V
V _{BE(sat)}	I _C =5A, I _B =5mA	3.0max	V
f _T	V _{CE} =12V, I _E =-0.5A	60typ	MHz
C _{OB}	V _{CB} =10V, f=1MHz	55typ	pF

*h_{FE} Rank \bar{O} (5000 to 12000), P(6500 to 20000), Y(15000 to 30000)

Typical Switching Characteristics (Common Emitter)

V _{CC} (V)	R _L (Ω)	I _C (A)	V _{BB1} (V)	V _{BB2} (V)	I _{B1} (mA)	I _{B2} (mA)	t _{on} (μs)	t _{stg} (μs)	t _f (μs)
30	6	5	10	-5	5	-5	0.8typ	6.2typ	1.1typ

External Dimensions FM100(TO3PF)

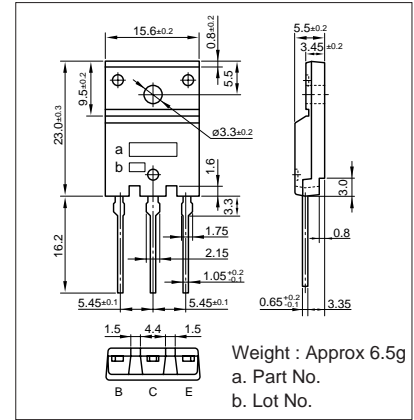

I_C-V_{CE} Characteristics (Typical)

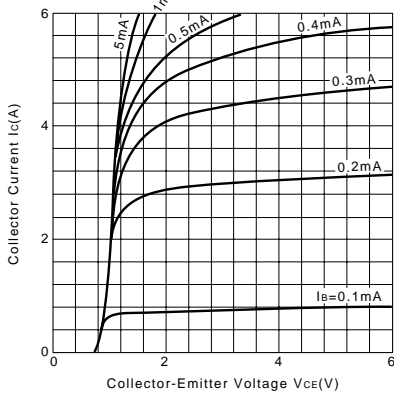

V_{CE(sat)}-I_B Characteristics (Typical)

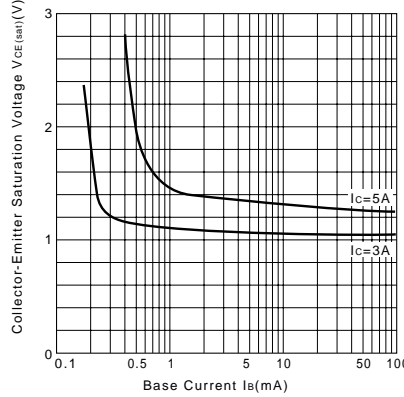

I_C-V_{BE} Temperature Characteristics (Typical)

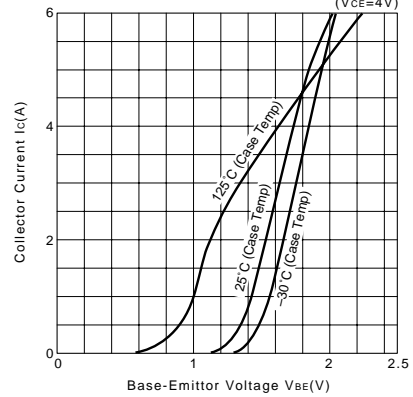

h_{FE}-I_C Characteristics (Typical)

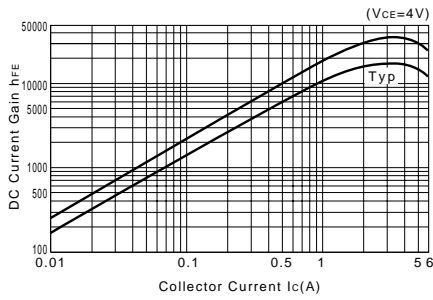

h_{FE}-I_C Temperature Characteristics (Typical)

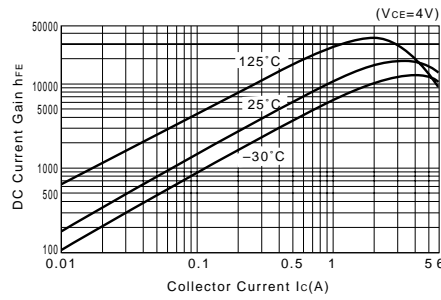

θ_{J-a}-t Characteristics

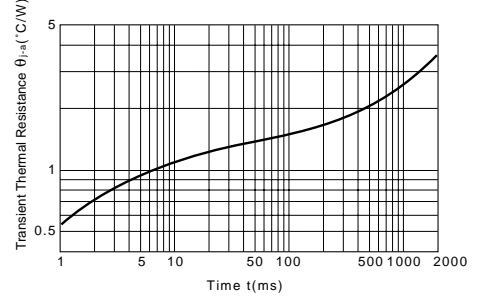

f_T-I_E Characteristics (Typical)

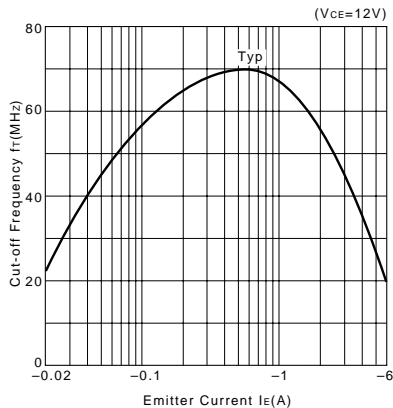

Safe Operating Area (Single Pulse)

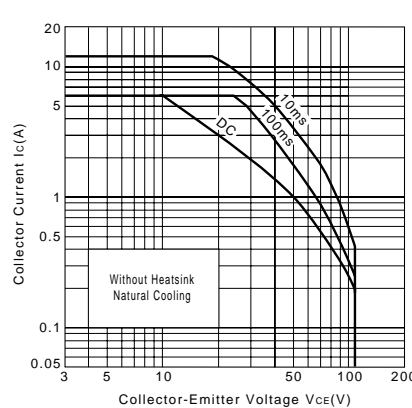

P_C-T_a Derating

