

Pilot Lights - 22 mm

M22

22-mm dia. and 25-mm dia. Round and Square Indicators

- Locking lever ensures easy mounting and removal of switch unit
- Use optional 25-mm dia. ring to install in 25-mm dia. panel cutouts
- Finger protection mechanism on Lamp Unit provided as a standard feature
- IP65 oil resistant: EN60947-5-1

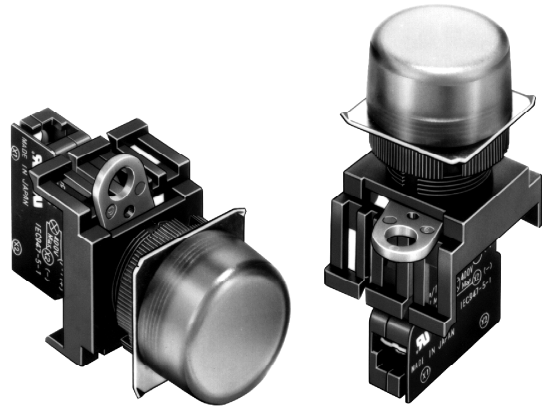

ISO 9001 Certified  
JGA-0421



EC97/1162 (1998.1.26)

This product was manufactured at OMRON Izumo. OMRON Izumo has obtained approvals from international certification bodies for its quality system and environmental control system.

## Ordering Information

### ■ CONSTRUCTION

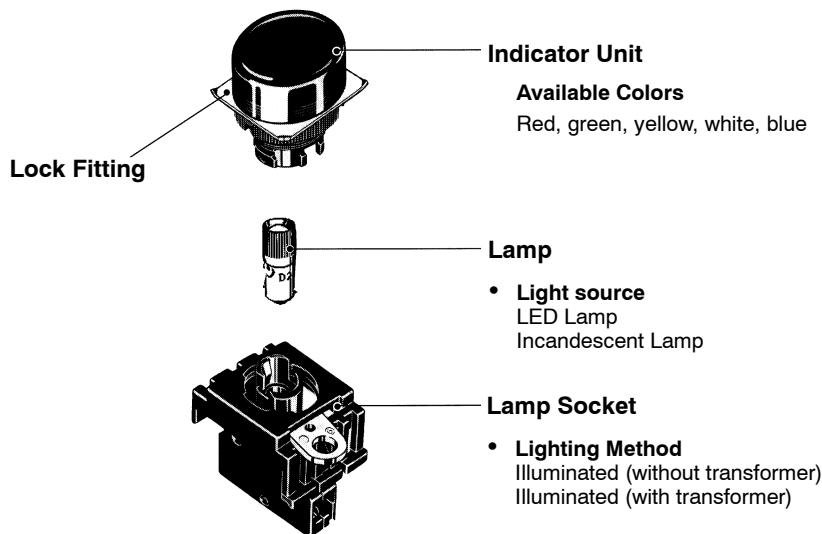

(Actual color of yellow pushbuttons more closely resembles amber than true yellow.)

**■ PART NUMBER LEGEND**

Shipped as a set which includes the Operational Unit, LED, and Lamp Socket.

M22-1-2-3

**1 Flange Shape**

Code	Description
F	Round/Flush
C	Square/Extended

**2 Illumination Color**

Code	Description
R	Red
G	Green
Y	Yellow
W	White
A	Blue



**3 Light Source**

Without transformer		
Code	LED	Operating voltage
6D	LED	6 VDC
6A		6 VAC
12A		12 VAC/DC
24A		24 VAC/DC
With transformer		
T1	LED	110 VAC
T2		220 VAC
Incandescent		
5		5 VAC
12		12 VAC
24		24 VAC
HI		110 VAC

Note: With the transformer types, LED lamp (24 VAC/DC) can be lit by directly applying 110 VAC/DC (220 VAC/DC) to the lamp terminal. The LED is 24-VAC/DC type.

(Actual color of yellow pushbuttons more closely resembles amber than true yellow.)

**■ M22 INDICATOR**

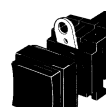
Appearance	Lighting	Rated voltage	Operator color	Part number	
Round/Flush Without transformer 	LED	6 VDC	Insert one of the following letters into the box <input type="checkbox"/> . R (red) Y (yellow) G (green) W (white) A (blue)	<b>M22-F□-6D</b>	
		6 VAC		<b>M22-F□-6A</b>	
		12 VAC/DC		<b>M22-F□-12A</b>	
		24 VAC/DC		<b>M22-F□-24A</b>	
Round/Flush With transformer 	LED	110 VAC		<b>M22-F□-T1</b>	
		220 VAC		<b>M22-F□-T2</b>	
Square/Extended Without transformer 	LED	6 VDC			<b>M22-C□-6D</b>
		6 VAC			<b>M22-C□-6A</b>
		12 VAC/DC			<b>M22-C□-12A</b>
		24 VAC/DC			<b>M22-C□-24A</b>
Square/Extended With transformer 	LED	110 VAC			<b>M22-C□-T1</b>
		220 VAC			<b>M22-C□-T2</b>

Note: To order Incandescent versions of the M22 Pilot Light, replace the last two digits in the part number (ie, 12A, 24A, T1) with the appropriate code from table 3 of the Part Number Legend at the top of the page.  
Example: M22-FR-24 is a red, round indicator with 24 VAC incandescent light source.

# Specifications

## ■ RATINGS

### LED Lamp

Rated voltage	Rated current	Operating voltage
6 VDC	60 mA	6 VDC $\pm$ 5%
6 VAC/DC	60 mA	6 VAC/DC $\pm$ 5%
12 VAC/DC	30 mA	12 VAC/DC $\pm$ 5%
24 VAC/DC	15 mA	24 VAC/DC $\pm$ 5%

### Incandescent Lamp

Rated voltage	Rated current	Operating voltage
6 VDC	200 mA	5 V
14 VAC/DC	80 mA	12 V
28 VAC/DC	40 mA	24 V
130 VAC/DC	20 mA	100 V

### Transformer Lighting

Rated voltage	Operational voltage	Applicable lamp (BA9S/13□ gold)
110 VAC	95 to 115 VAC	LED Lamp (A22-24□)
220 VAC	190 to 230 VAC	

## ■ APPROVED STANDARDS

Recognized organization	Standards	File No.
UL, cUL (See note)	UL508	E41515
ASTA	EN60947-5-1	—

Note: UL: CSA C22 No. 14

# Dimensions

Unit: mm (inch)

## ■ INDICATORS

### Flush M22-F

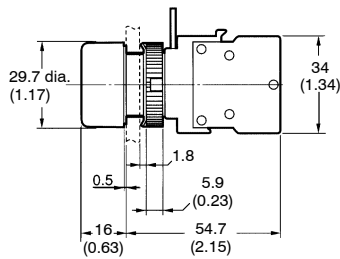

### Square M22-C

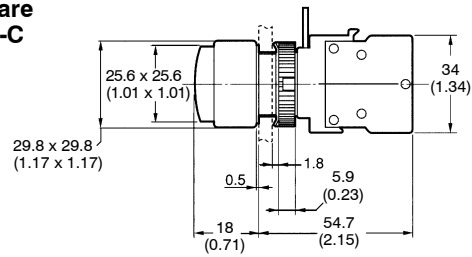

## ■ TERMINAL ARRANGEMENT

### Terminal Arrangement (Bottom View)

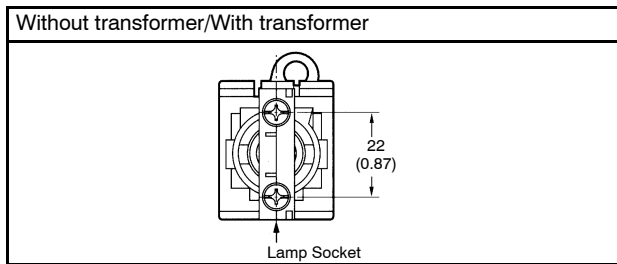

## ■ TERMINAL CONNECTION

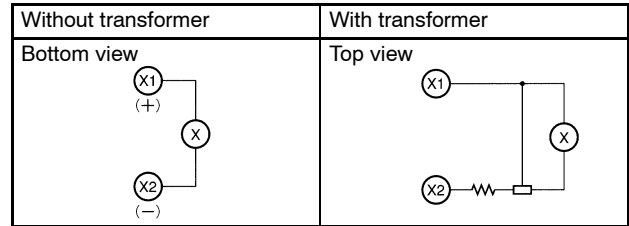

## ■ PANEL CUTOUT DIMENSIONS

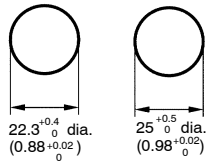

Note: When applying a coating such as paint to a panel, the dimensions should be those after the application of the coating. A lock fitting is provided as a standard item.

Note: For additional specifications and information refer to the *Common to all assemblies* section at the end of this publication.

**NOTE: DIMENSIONS SHOWN ARE IN MILLIMETERS. To convert millimeters to inches divide by 25.4.**

# OMRON®

**OMRON ELECTRONICS LLC**

One East Commerce Drive  
Schaumburg, IL 60173

**1-800-55-OMRON**

**OMRON ON-LINE**

Global - <http://www.omron.com>

USA - <http://www.omron.com/oei>

Canada - <http://www.omron.com/oci>

**OMRON CANADA, INC.**

885 Milner Avenue  
Scarborough, Ontario M1B 5V8

**416-286-6465**