

CGJ5L2X7R0J335K160AA

TDK Item Description : CGJ5L2X7R0J335KT****



Application & Main Feature

High Reliability Grade (General (Up to 50V))

Series

CGJ5(3216) [EIA CC1206]

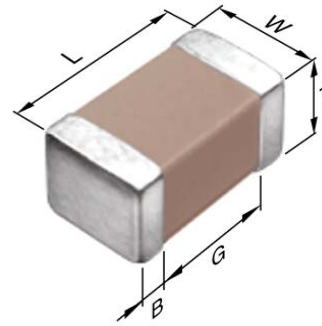

Dimensions

L 3.20mm +0.3,-0.1mm
 W 1.60mm +0.3,-0.1mm
 T 1.60mm +0.3,-0.1mm
 B 0.20mm Min.
 G 1.00mm Min.

Temperature Characteristic

X7R (-55 to 125 degC +/-15%)

Rated Voltage

0J (6.3Vdc)

Capacitance

3.3uF

Capacitance Tolerance

K (+/-10%)

Dissipation Factor

7.5% Max.

Insulation Resistance

30Mohm Min.

AEC-Q200

Yes

DC Bias Characteristic

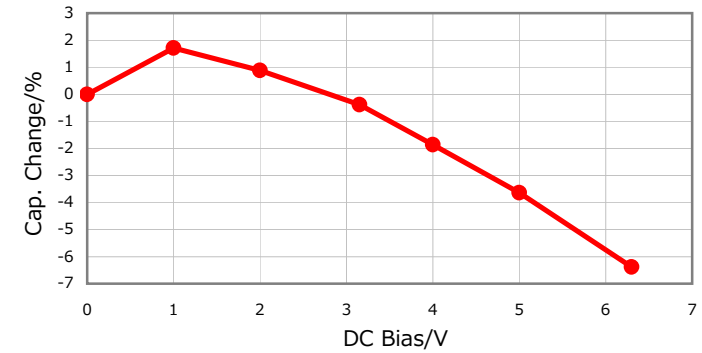

|Z|, ESR vs. Freq. Characteristics

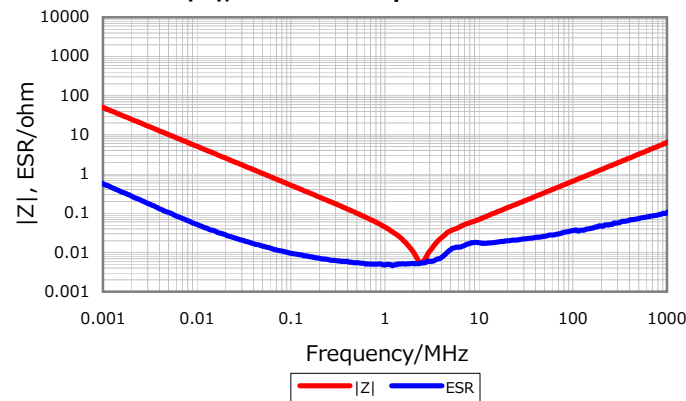

Temperature Characteristics

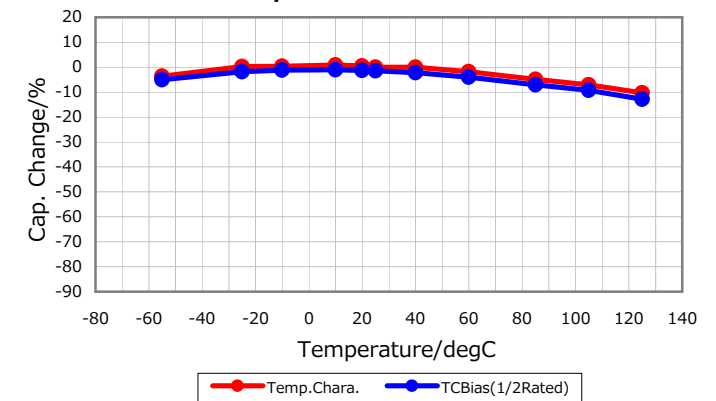

Cap. vs. Freq. Characteristic

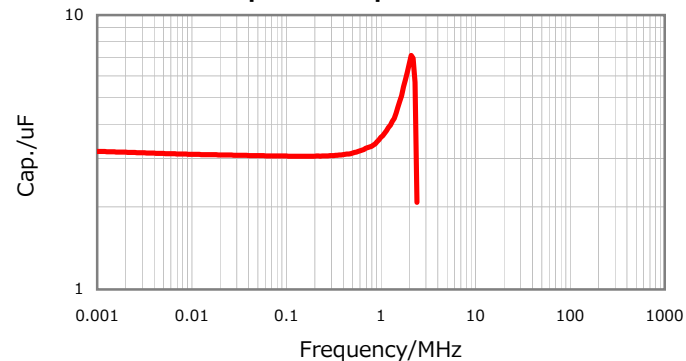

Ripple Temperature Rise Characteristics

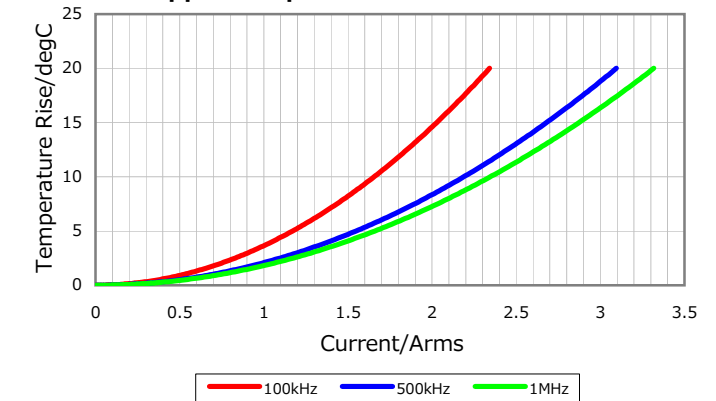

Characterization Sheet (Multilayer Ceramic Chip Capacitors)



All specifications are subject to change without notice.

January 4, 2016