

TPA IN FULL-LOCK (AS SHIPPED) POSITION AND LATCH IN PARTIALLY OPEN POSITION

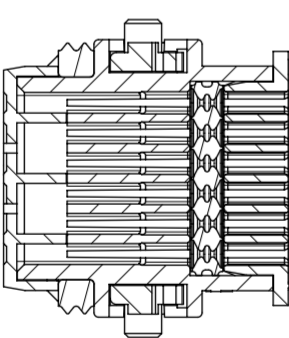

SECTION C-C

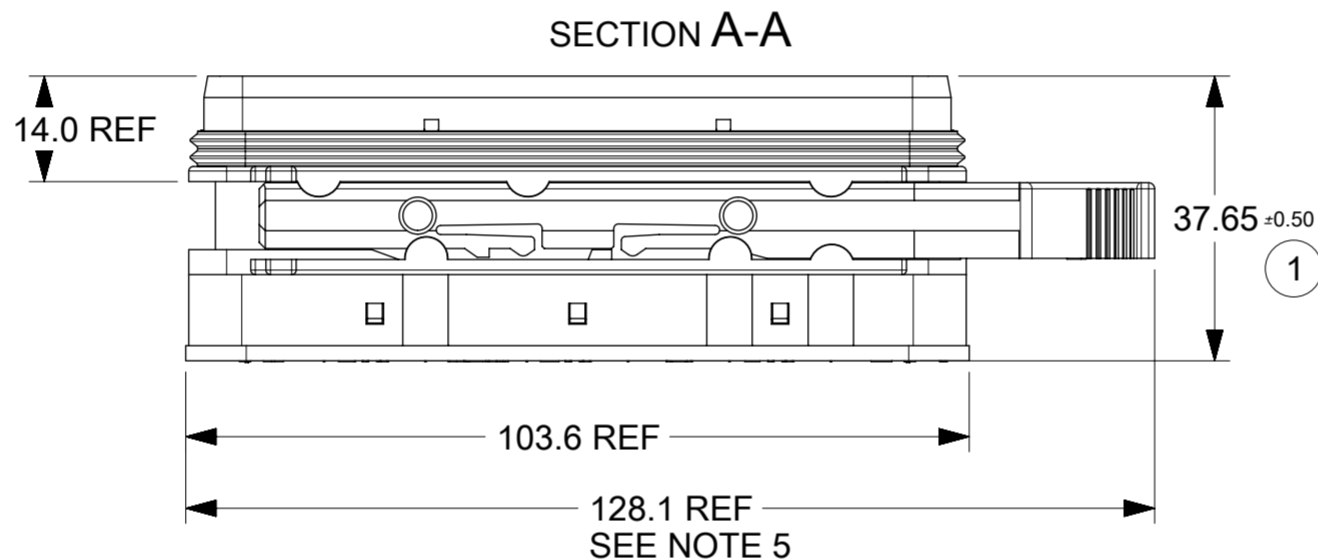
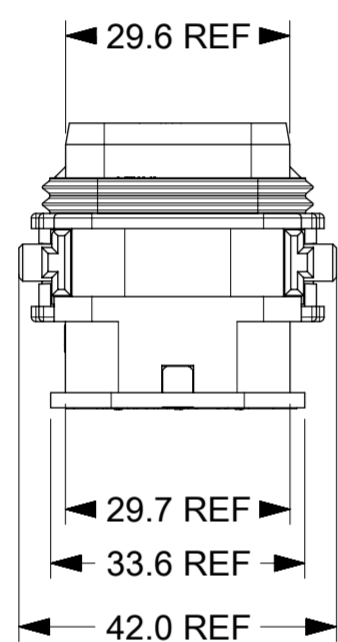
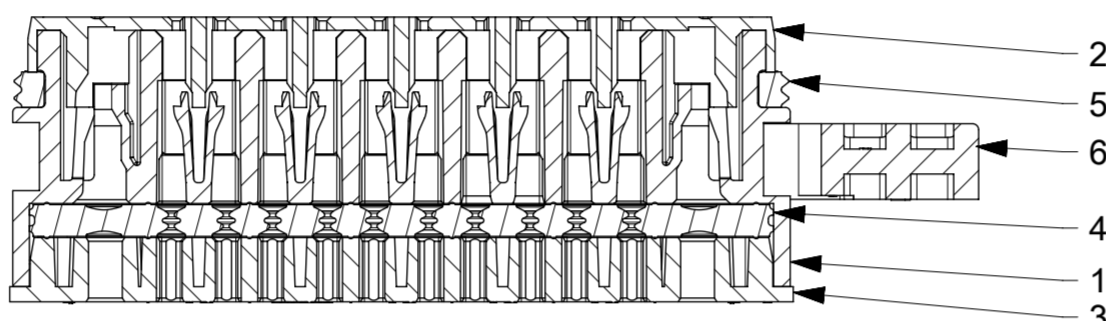
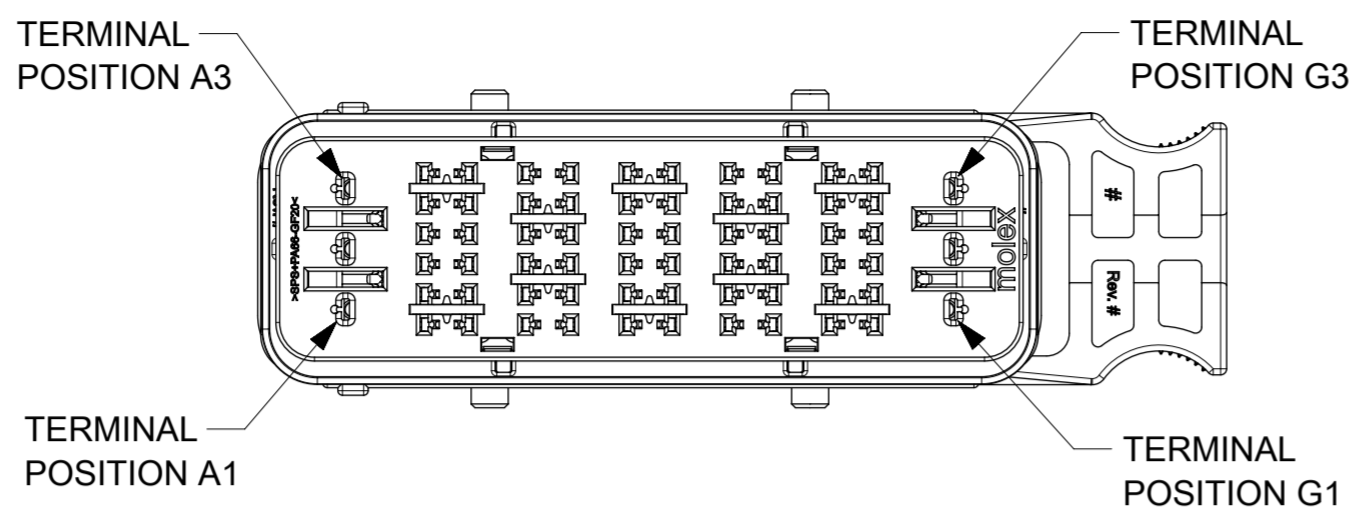
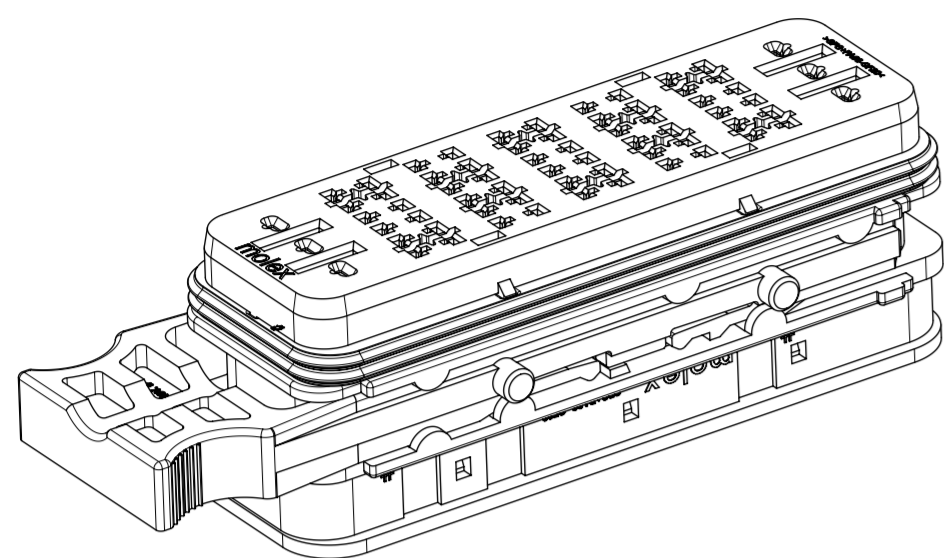
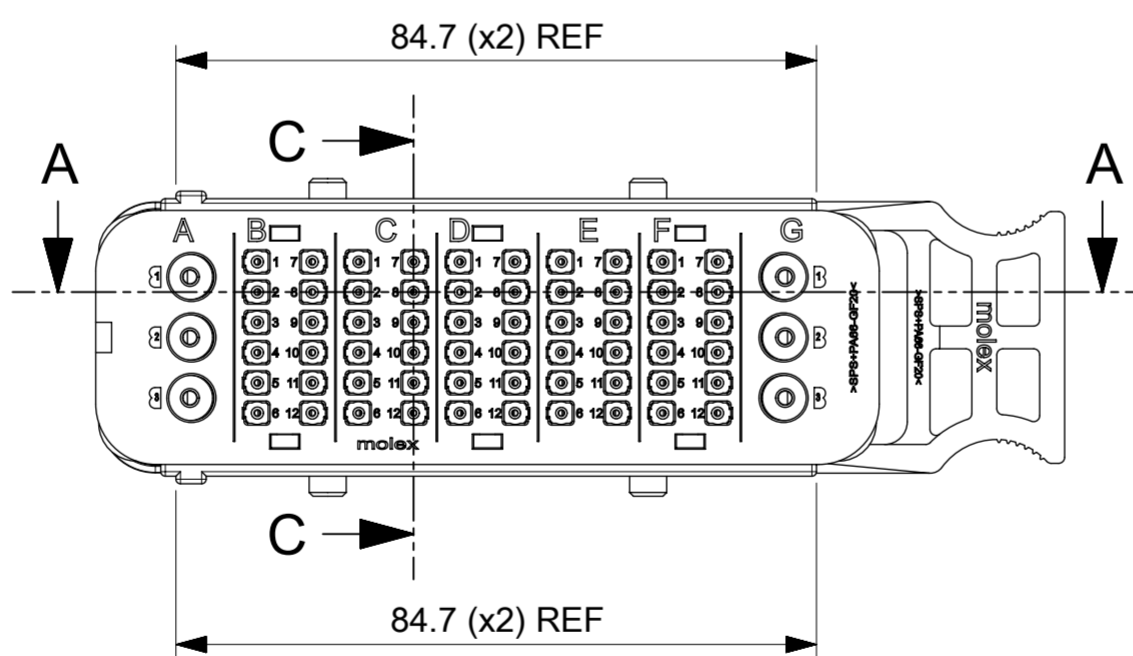

TPA IN PRE-LOAD POSITION AND LATCH IN OPEN POSITION

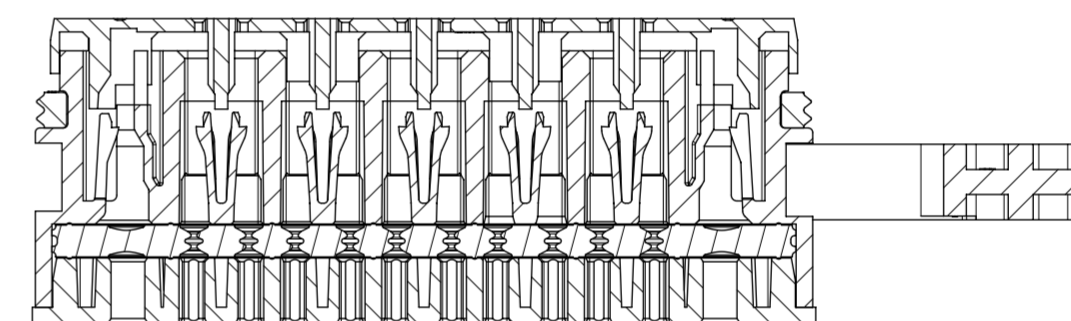
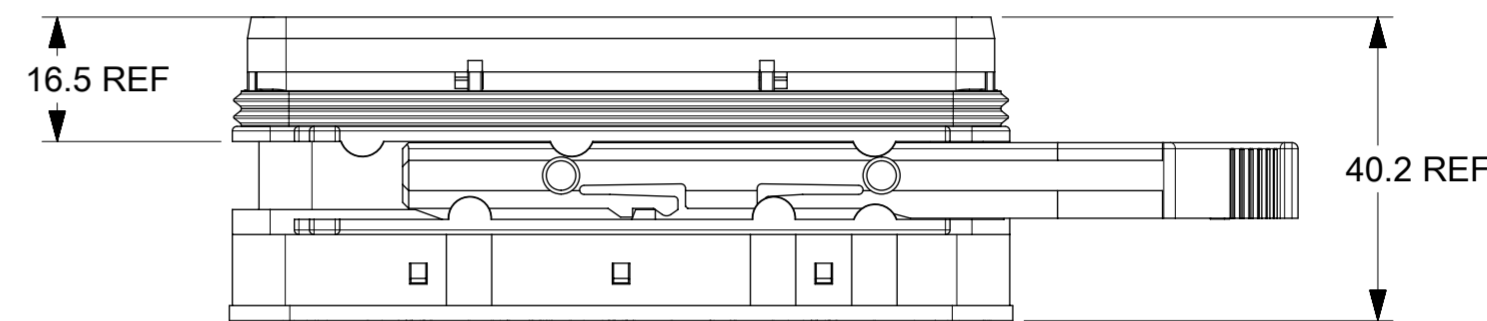
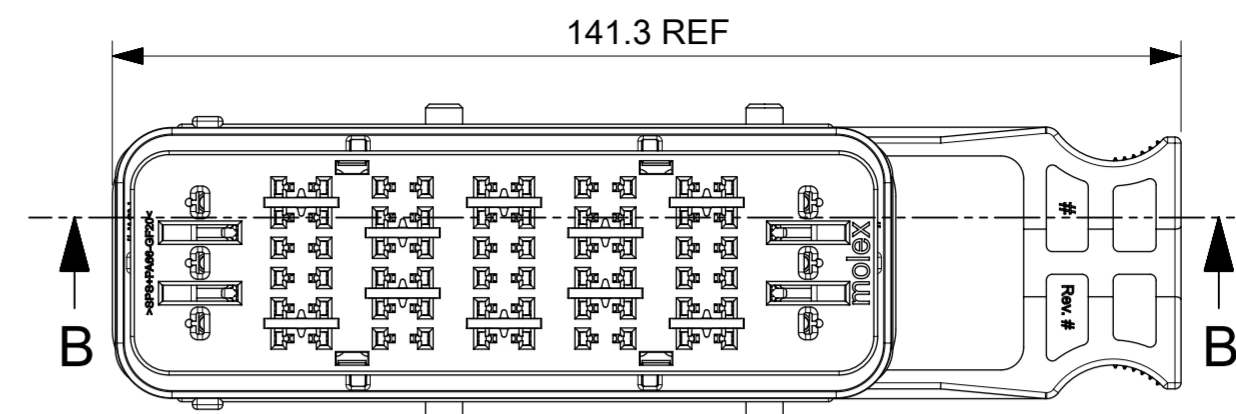

SECTION B-B

NOTES:

- MATERIALS: HOUSINGS: POLYSTYRENE/NYLON BLEND, GLASS FILLED, UL 94 HB
SEALS: SILICONE RUBBER
- MX150 RECEPTACLE TERMINALS PER SD-33012-002 TO BE USED WITH THIS ASSEMBLY IN CAVITIES B, C, D, E & F CRIMPED WITH CABLE INSULATION OUTER DIAMETER IN THE RANGE 1.5mm TO 2.7mm
- MX150L RECEPTACLE TERMINALS PER SD-19434-00* TO BE USED WITH THIS ASSEMBLY IN CAVITIES A & G CRIMPED WITH CABLE INSULATION OUTER DIAMETER IN THE RANGE 3.0mm TO 5.0mm
- PRODUCT SPECIFICATION: 850830010 PSP
- PACKAGING SPECIFICATION: 850700010 PSK, LATCH SHIPPED IN PARTIALLY OPEN POSITION
- MATES WITH: SRC 60+6AG POWER BLADE HOUSING ASSEMBLY PART NUMBER 850830300 PER 850830300 PSD OR 937926006 PER 937921000 PSD
- APPLICATION SPECIFICATION: 850830010 PSA
- CONDUIT INTERFACE OPTIONS: REFER TO 934811000 PSD

INSPECTION NUMBERS RESERVED FOR THIS SHEET: 1-50
LAST INSPECTION NUMBER USED: 1

| No. | DESCRIPTION | QTY. | COLOUR |
|-----|--------------------|------|------------|
| 6 | SLIDING LATCH | 1 | BLACK |
| 5 | FEMALE FRONT SEAL | 1 | RED |
| 4 | FEMALE BACK SEAL | 1 | LIGHT BLUE |
| 3 | FEMALE REAR COVER | 1 | BLACK |
| 2 | FEMALE FRONT COVER | 1 | GREEN |
| 1 | FEMALE HOUSING | 1 | BLACK |

BILL OF MATERIAL

| | | | | |
|--|---|------------------------|-----------------|-----------------|
| QUALITY SYMBOLS | THIS DRAWING CONTAINS INFORMATION THAT IS PROPRIETARY TO MOLEX ELECTRONIC TECHNOLOGIES, LLC AND SHOULD NOT BE USED WITHOUT WRITTEN PERMISSION | | | |
| | ▽ = 0 | ▽ = 0 | ▽ = 0 | ▽ = 0 |
| | ▽ = 0 | ▽ = 0 | ▽ = 0 | ▽ = 0 |
| | ▽ = 0 | ▽ = 0 | ▽ = 0 | ▽ = 0 |
| REPLACE SD-85084-700 | EC NO: 102579 | DRWN: AJOBRIEN | CHKD: SMCGREEVY | APPR: JDWALLACE |
| 2016/01/21 | 2016/01/22 | 2016/01/26 | | |
| GENERAL TOLERANCES (UNLESS SPECIFIED) | DIMENSION UNITS | SCALE | | |
| ANGULAR TOL ± 0.5 ° | MM | 1:1 | | |
| 4 PLACES ± | DRWN BY | DATE | | |
| 3 PLACES ± | AJOBRIEN | 2016/01/21 | | |
| 2 PLACES ± 0.2 | CHK'D BY | DATE | | |
| 1 PLACE ± 0.5 | SMCGREEVY | 2016/01/22 | | |
| 0 PLACES ± | APPR BY | DATE | | |
| DRAFT WHERE APPLICABLE MUST REMAIN WITHIN DIMENSIONS | JDWALLACE | 2016/01/26 | | |
| A2 | DRAWING SIZE | THIRD ANGLE PROJECTION | | |
| PRODUCT CUSTOMER DRAWING | | | SERIES | MATERIAL NUMBER |
| | | | 85084 | 850840700 |
| | | | CUSTOMER | GENERAL MARKET |
| | | | DOCUMENT NUMBER | DOC TYPE |
| | | | 850840700 | 000 |
| | | | DOC PART | SHEET NUMBER |
| | | | | 1 OF 8 |

NOTES:

1. SEE SHEET 1 FOR UNSPECIFIED NOTES AND DIMENSIONS
2. MX150 RECEPTACLE TERMINALS PER SD-33012-002 TO BE USED WITH THIS ASSEMBLY IN CAVITIES A, B, C, E, F & G CRIMPED WITH CABLE INSULATION OUTER DIAMETER IN THE RANGE 1.5mm TO 2.7mm
3. MX150L RECEPTACLE TERMINALS PER SD-19434-00* TO BE USED WITH THIS ASSEMBLY IN CAVITY D CRIMPED WITH CABLE INSULATION OUTER DIAMETER IN THE RANGE 3.0mm TO 5.0mm
4. MATES WITH: SRC 72+2D POWER BLADE HOUSING ASSEMBLY PART NUMBER 937927202 PER 937921000 PSD

| 6 | SLIDING LATCH | 1 | BLACK |
|------------------|--------------------|------|------------|
| 5 | FEMALE FRONT SEAL | 1 | RED |
| 4 | FEMALE BACK SEAL | 1 | LIGHT BLUE |
| 3 | FEMALE REAR COVER | 1 | BLACK |
| 2 | FEMALE FRONT COVER | 1 | GREEN |
| 1 | FEMALE HOUSING | 1 | BLACK |
| No. | DESCRIPTION | QTY. | COLOUR |
| BILL OF MATERIAL | | | |

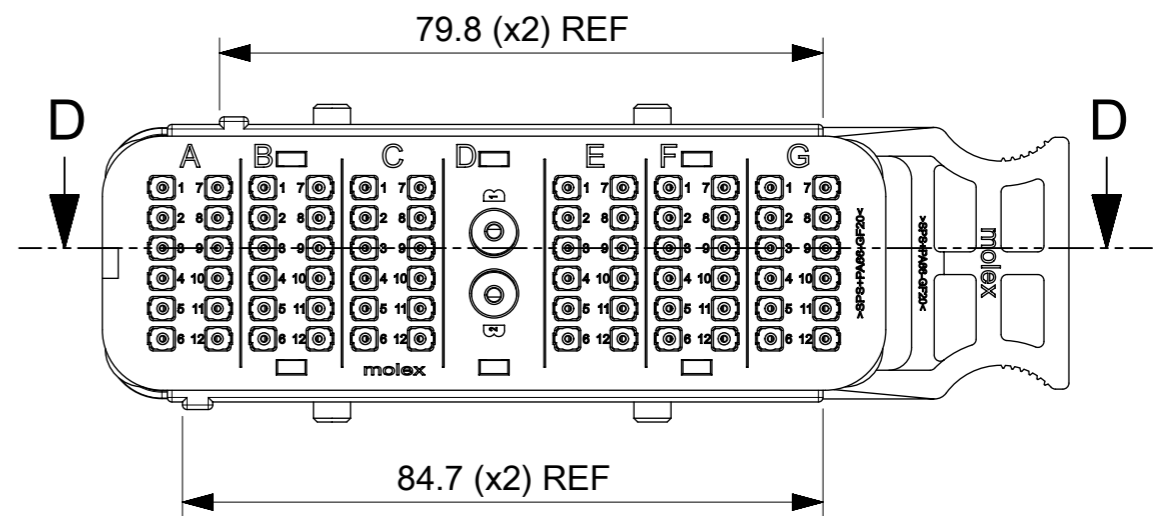
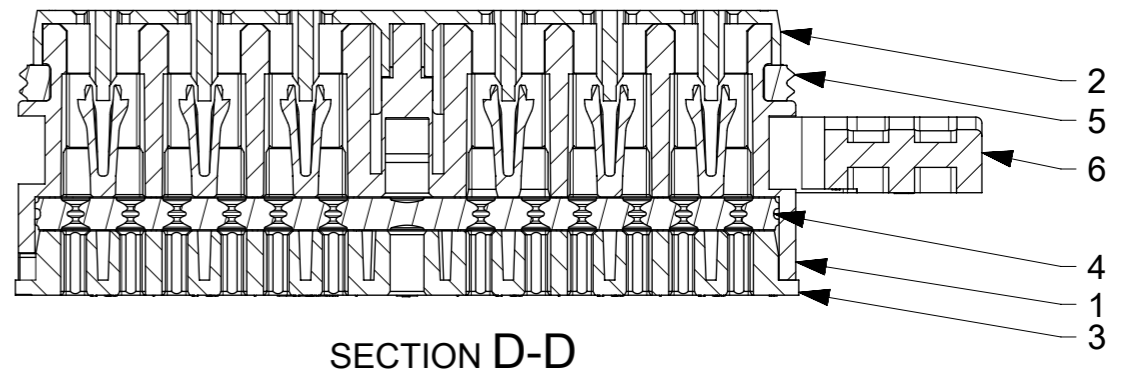
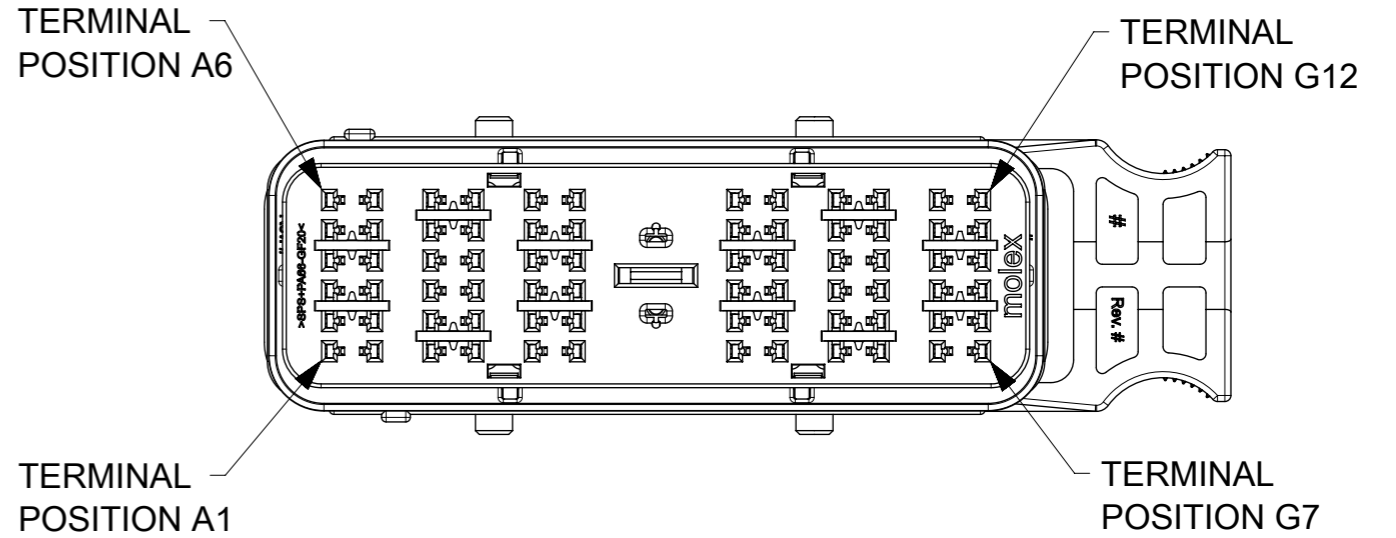
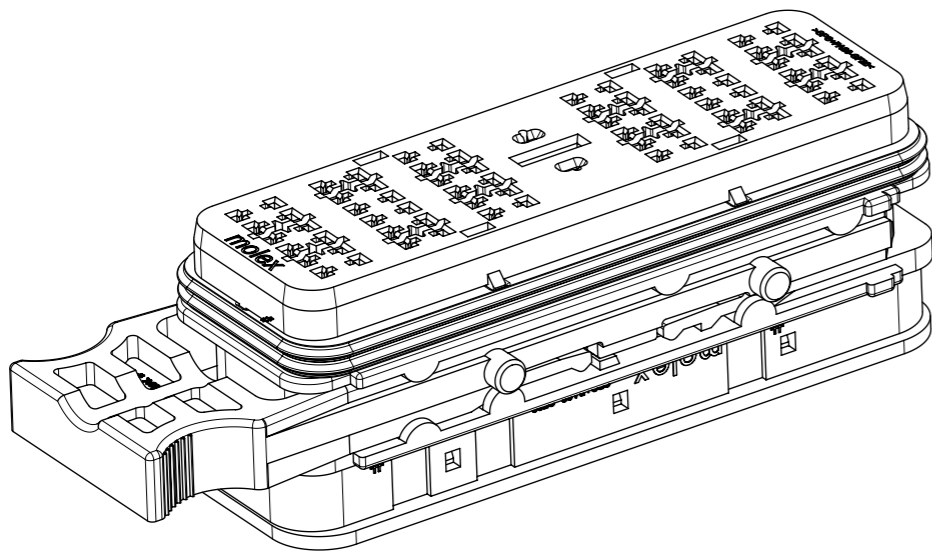

| | | | | | | | | | | |
|--|---|--|--|----------------------------|-----------------------------------|--------------------------|------------------|--------------------------|--|--|
| QUALITY SYMBOLS ▽ = 0 ▽ = 0 ▽ = 0 ▼ = 0 ▽ = 0 ⊗ = 0 ■ = 0 ▽ = 0 | THIS DRAWING CONTAINS INFORMATION THAT IS PROPRIETARY TO MOLEX ELECTRONIC TECHNOLOGIES, LLC AND SHOULD NOT BE USED WITHOUT WRITTEN PERMISSION | | | | DIMENSION UNITS: MM SCALE: 1:1 | | | | | |
| | EC NO: 102579 DRWN: AJOBRIEN CHK'D: SMCGREEVY APPR: JDWALLACE | 2016/01/21 2016/01/22 2016/01/26 | GENERAL TOLERANCES (UNLESS SPECIFIED) ANGULAR TOL ± 0.5 ° | | DRWN BY: AJOBRIEN | DATE: 2016/01/21 | | | | |
| | | | 4 PLACES ± | 3 PLACES ± | CHK'D BY: SMCGREEVY | DATE: 2016/01/22 | | | | |
| | | | 2 PLACES ± 0.2 | 1 PLACE ± 0.5 | 0 PLACES ± | APPR BY: JDWALLACE | DATE: 2016/01/26 | PRODUCT CUSTOMER DRAWING | | |
| DRAFT WHERE APPLICABLE MUST REMAIN WITHIN DIMENSIONS | | DRAWING SIZE: A3 | THIRD ANGLE PROJECTION | SERIES: 85084 | MATERIAL NUMBER: 850847202 | CUSTOMER: GENERAL MARKET | | | | |
| | | | | DOCUMENT NUMBER: 850840700 | | DOC TYPE: PSD | DOC PART: 000 | SHEET NUMBER: 2 OF 8 | | |

NOTES:

1. SEE SHEET 1 FOR UNSPECIFIED NOTES AND DIMENSIONS
2. MX150 RECEPTACLE TERMINALS PER SD-33012-002 TO BE USED WITH THIS ASSEMBLY IN CAVITIES B, C, E & F CRIMPED WITH CABLE INSULATION OUTER DIAMETER IN THE RANGE 1.5mm TO 2.7mm
3. MX150L RECEPTACLE TERMINALS PER SD-19434-00* TO BE USED WITH THIS ASSEMBLY IN CAVITIES A, D & G CRIMPED WITH CABLE INSULATION OUTER DIAMETER IN THE RANGE 3.0mm TO 5.0mm
4. MATES WITH: SRC 48+8ADG POWER BLADE HOUSING ASSEMBLY PART NUMBER 937924808 PER 937921000 PSD

| No. | DESCRIPTION | QTY. | COLOUR |
|-----|--------------------|------------------|--------|
| 6 | SLIDING LATCH | 1 | BLACK |
| 5 | FEMALE FRONT SEAL | 1 | RED |
| 4 | FEMALE BACK SEAL | 1 <td LIGHT BLUE | |
| 3 | FEMALE REAR COVER | 1 | BLACK |
| 2 | FEMALE FRONT COVER | 1 | GREEN |
| 1 | FEMALE HOUSING | 1 | BLACK |

BILL OF MATERIAL

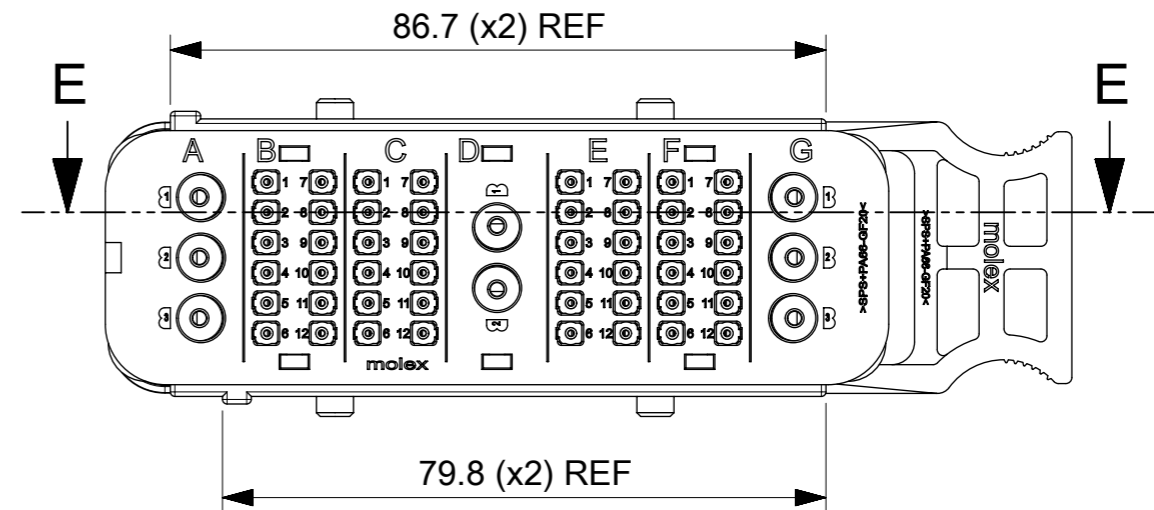
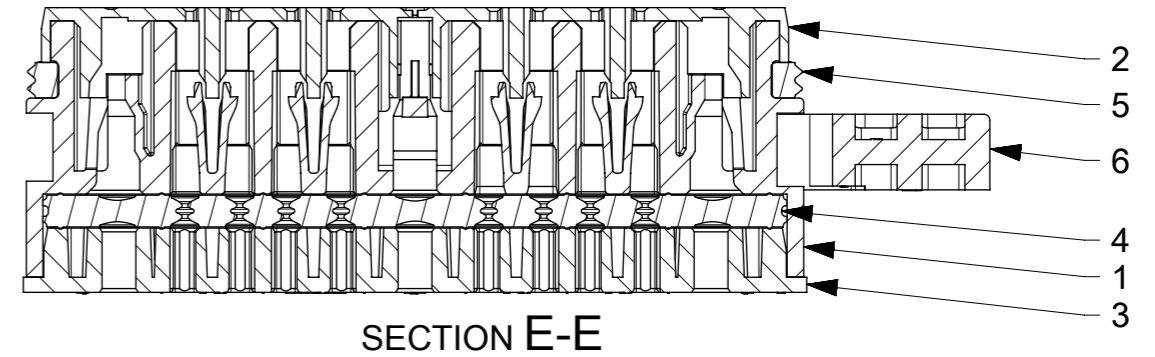
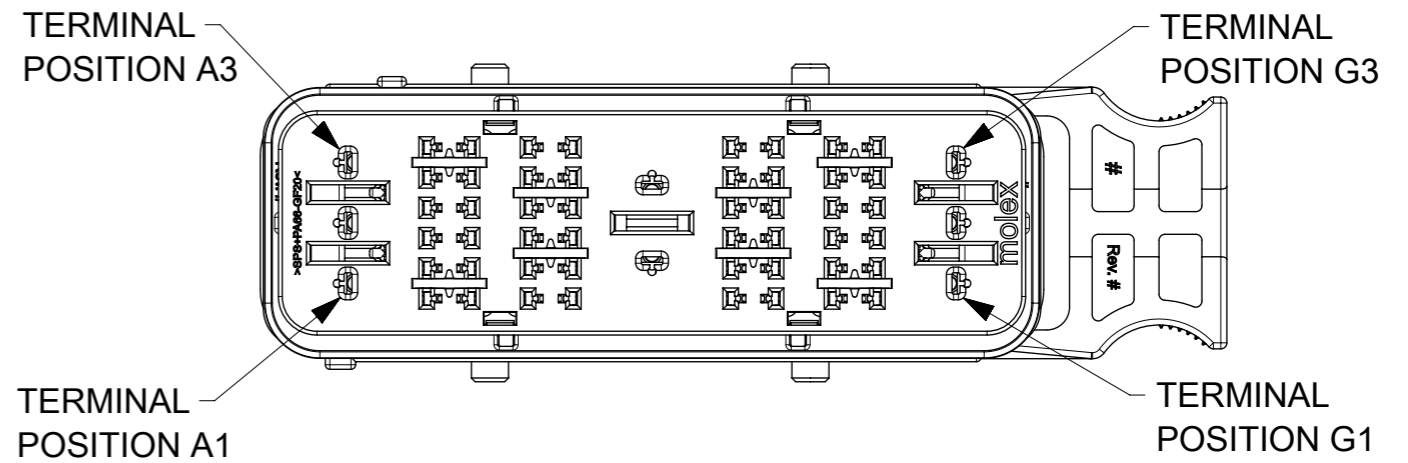
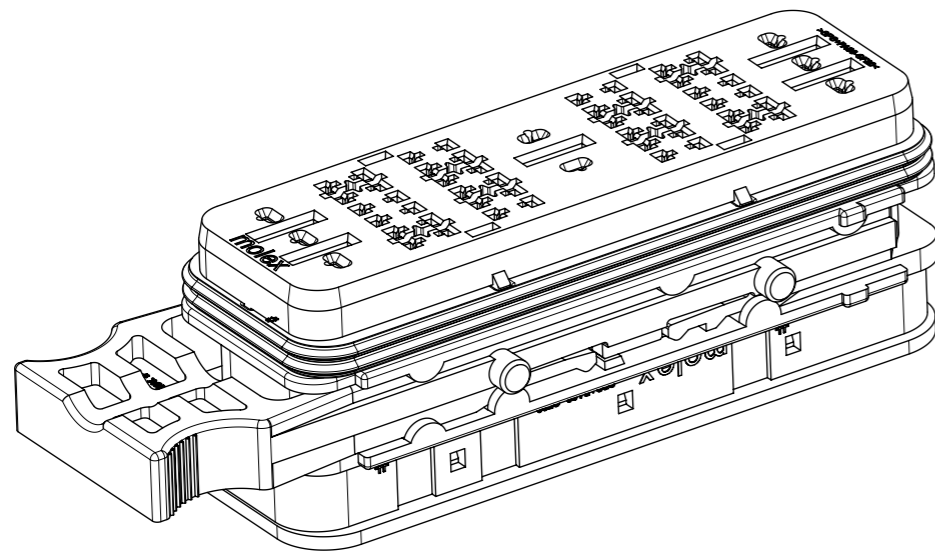

| QUALITY SYMBOLS | | THIS DRAWING CONTAINS INFORMATION THAT IS PROPRIETARY TO MOLEX ELECTRONIC TECHNOLOGIES, LLC AND SHOULD NOT BE USED WITHOUT WRITTEN PERMISSION | | | | | | | | | | |
|-----------------|-----|---|---------------------------------------|--|-----------------|--------------|------------|------------------------|--|---|--|--------------------------|
| ▽A | = 0 | REPLACE SD-85084-700 EC NO: 102579 DRWN: AJOBRIEN CHK'D: SMCGREEVY APPR: JDWALLACE | GENERAL TOLERANCES (UNLESS SPECIFIED) | | DIMENSION UNITS | | SCALE | | | | | |
| ▽E | = 0 | | ANGULAR TOL ± 0.5 ° | | MM | | 1:1 | | | | | |
| ▽F | = 0 | | 4 PLACES ± | | DRWN BY | | DATE | | SRC MIXED POWER FEMALE RECEPTACLE HOUSING ASSEMBLY | | | |
| ▽ | = 0 | | 3 PLACES ± | | AJOBRIEN | | 2016/01/21 | | | | | |
| ▽C | = 0 | | 2 PLACES ± 0.2 | | CHK'D BY | | DATE | | | | | PRODUCT CUSTOMER DRAWING |
| ▽ | = 0 | | 1 PLACE ± 0.5 | | SMCGREEVY | | 2016/01/22 | | | | | |
| ▽ | = 0 | 0 PLACES ± | | DRAFT WHERE APPLICABLE MUST REMAIN WITHIN DIMENSIONS | | APPR BY | | DATE | | SERIES: 85084 MATERIAL NUMBER: 850844808 CUSTOMER: GENERAL MARKET | | |
| ▽ | = 0 | A | | REV | | DRAWING SIZE | | THIRD ANGLE PROJECTION | | DOCUMENT NUMBER: 850840700 DOC TYPE: PSD DOC PART: 000 SHEET NUMBER: 3 OF 8 | | |
| ▽ | = 0 | | | | | A3 | | | | | | |

NOTES:

1. SEE SHEET 1 FOR UNSPECIFIED NOTES AND DIMENSIONS
2. MX150 RECEPTACLE TERMINALS PER SD-33012-002 TO BE USED WITH THIS ASSEMBLY IN CAVITIES B, D & F CRIMPED WITH CABLE INSULATION OUTER DIAMETER IN THE RANGE 1.5mm TO 2.7mm
3. MX150L RECEPTACLE TERMINALS PER SD-19434-00* TO BE USED WITH THIS ASSEMBLY IN CAVITIES A, C, E & G CRIMPED WITH CABLE INSULATION OUTER DIAMETER IN THE RANGE 3.0mm TO 5.0mm
4. MATES WITH: SRC 36+12ACEG POWER BLADE HOUSING ASSEMBLY PART NUMBER 937923612 PER 937921000 PSD

| 6 | SLIDING LATCH | 1 | BLACK |
|------------------|--------------------|------|------------|
| 5 | FEMALE FRONT SEAL | 1 | RED |
| 4 | FEMALE BACK SEAL | 1 | LIGHT BLUE |
| 3 | FEMALE REAR COVER | 1 | BLACK |
| 2 | FEMALE FRONT COVER | 1 | GREEN |
| 1 | FEMALE HOUSING | 1 | BLACK |
| No. | DESCRIPTION | QTY. | COLOUR |
| BILL OF MATERIAL | | | |

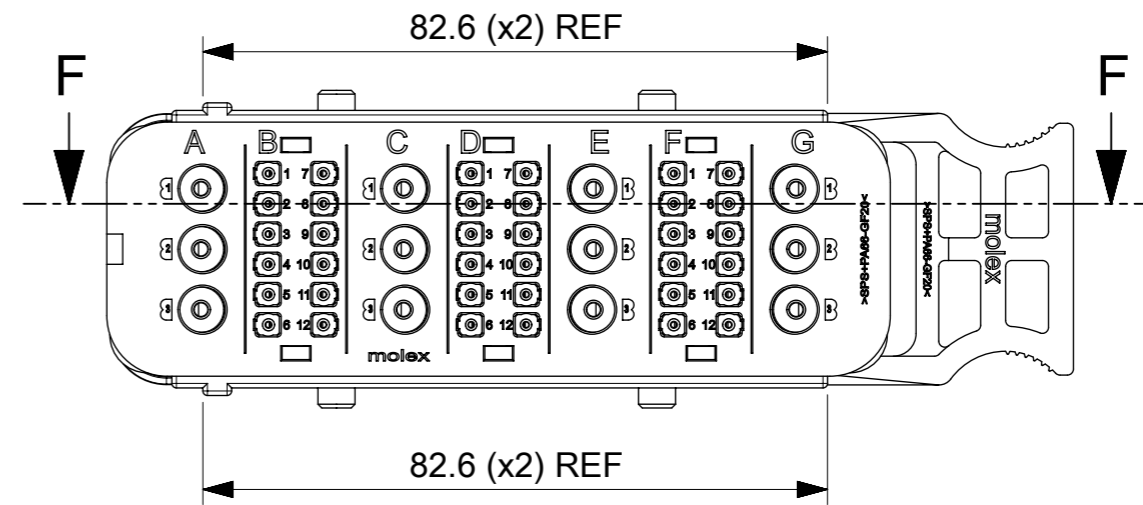
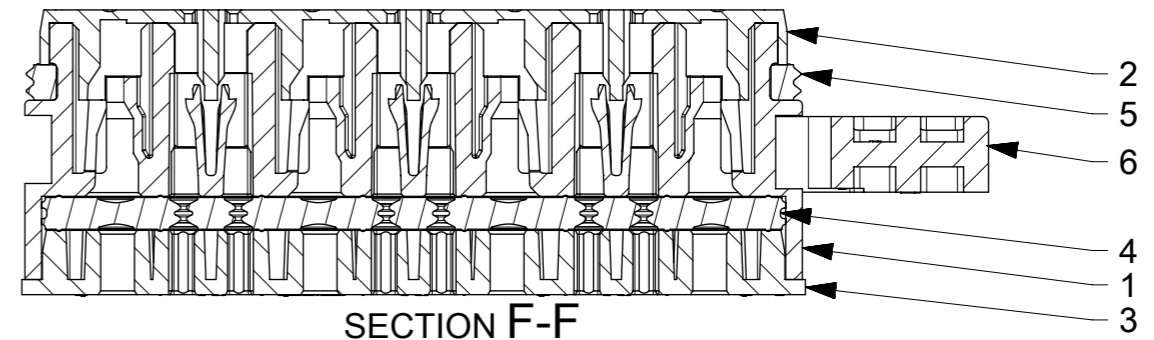
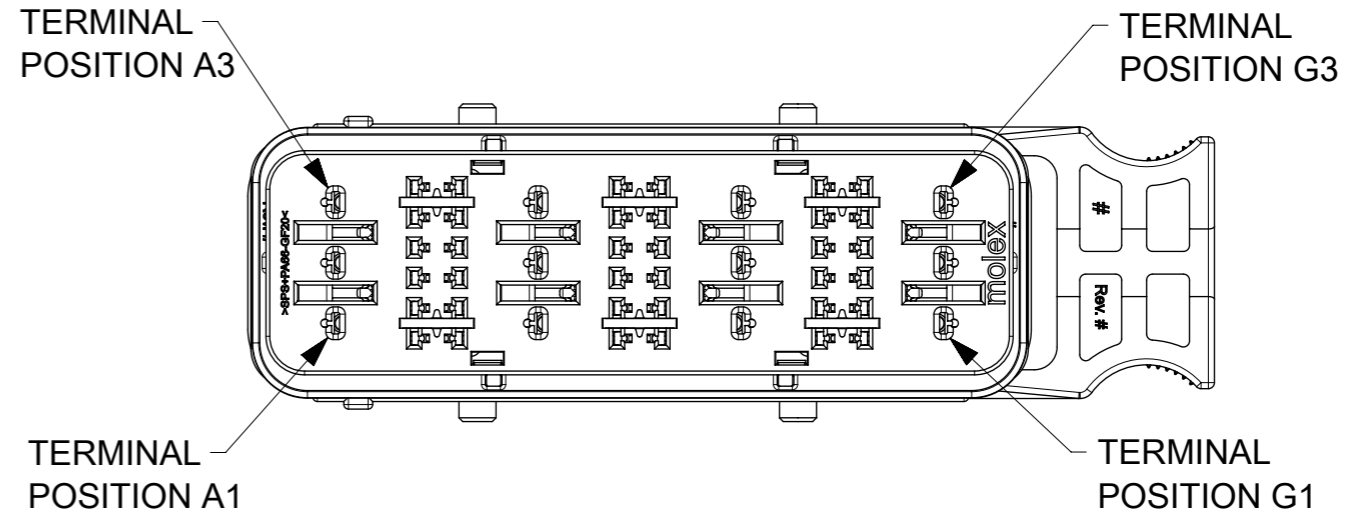
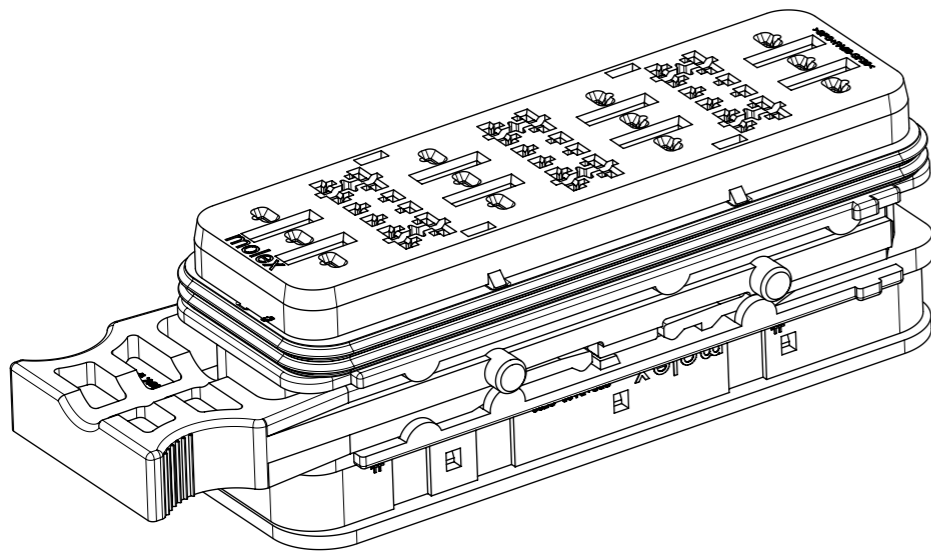

| | | | | | | | | | | |
|---|--|--|---|--------------|---|-------|--|-----------------|----------------|--------------|
| THIS DRAWING CONTAINS INFORMATION THAT IS PROPRIETARY TO MOLEX ELECTRONIC TECHNOLOGIES, LLC AND SHOULD NOT BE USED WITHOUT WRITTEN PERMISSION | | | | | | | | | | |
| QUALITY SYMBOLS ▽ = 0 ▽ = 0 ▽ = 0 ▼ = 0 ▽ = 0 ⊗ = 0 ■ = 0 ▽ = 0 | EC NO: 102579 DRWN: AJOBRIEN CHK'D: SMCGREEVY APPR: JDWALLACE | 2016/01/21 2016/01/22 2016/01/26 | GENERAL TOLERANCES (UNLESS SPECIFIED) ANGULAR TOL ± 0.5 ° | | DIMENSION UNITS | SCALE | | | | |
| | | | MM | 1:1 | DRWN BY: AJOBRIEN DATE: 2016/01/21 | | | | | |
| REPLACE SD-85084-700 | | EC NO: 102579 DRWN: AJOBRIEN CHK'D: SMCGREEVY APPR: JDWALLACE | 4 PLACES ± 3 PLACES ± 2 PLACES ± 0.2 1 PLACE ± 0.5 0 PLACES ± | | CHK'D BY: SMCGREEVY DATE: 2016/01/22 | | SRC MIXED POWER FEMALE RECEPTACLE HOUSING ASSEMBLY | | | |
| DRAFT WHERE APPLICABLE MUST REMAIN WITHIN DIMENSIONS | | | APPR BY: JDWALLACE DATE: 2016/01/26 | | | | | | | |
| | | | | DRAWING SIZE | THIRD ANGLE PROJECTION | | PRODUCT CUSTOMER DRAWING | | | |
| | | | | A3 | | | SERIES | MATERIAL NUMBER | CUSTOMER | |
| | | | | | | | 85084 | 850843612 | GENERAL MARKET | |
| | | | | | | | DOCUMENT NUMBER | DOC TYPE | DOC PART | SHEET NUMBER |
| | | | | | | | 850840700 | PSD | 000 | 4 OF 8 |

NOTES:

1. SEE SHEET 1 FOR UNSPECIFIED NOTES AND DIMENSIONS
2. MX150 RECEPTACLE TERMINALS PER SD-33012-002 TO BE USED WITH THIS ASSEMBLY IN CAVITIES B & F CRIMPED WITH CABLE INSULATION OUTER DIAMETER IN THE RANGE 1.5mm TO 2.7mm
3. MX150L RECEPTACLE TERMINALS PER SD-19434-00* TO BE USED WITH THIS ASSEMBLY IN CAVITIES A, C, D, E & G CRIMPED WITH CABLE INSULATION OUTER DIAMETER IN THE RANGE 3.0mm TO 5.0mm
4. MATES WITH: SRC 24+14ACDEG POWER BLADE HOUSING ASSEMBLY PART NUMBER 937922414 PER 937921000 PSD

| 6 | SLIDING LATCH | 1 | BLACK |
|------------------|--------------------|------|------------|
| 5 | FEMALE FRONT SEAL | 1 | RED |
| 4 | FEMALE BACK SEAL | 1 | LIGHT BLUE |
| 3 | FEMALE REAR COVER | 1 | BLACK |
| 2 | FEMALE FRONT COVER | 1 | GREEN |
| 1 | FEMALE HOUSING | 1 | BLACK |
| No. | DESCRIPTION | QTY. | COLOUR |
| BILL OF MATERIAL | | | |

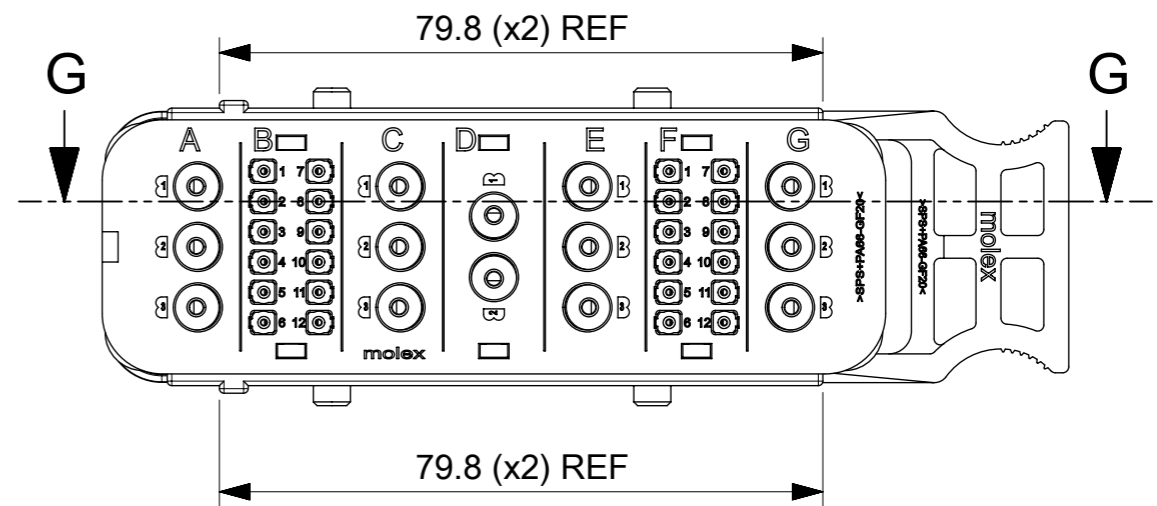
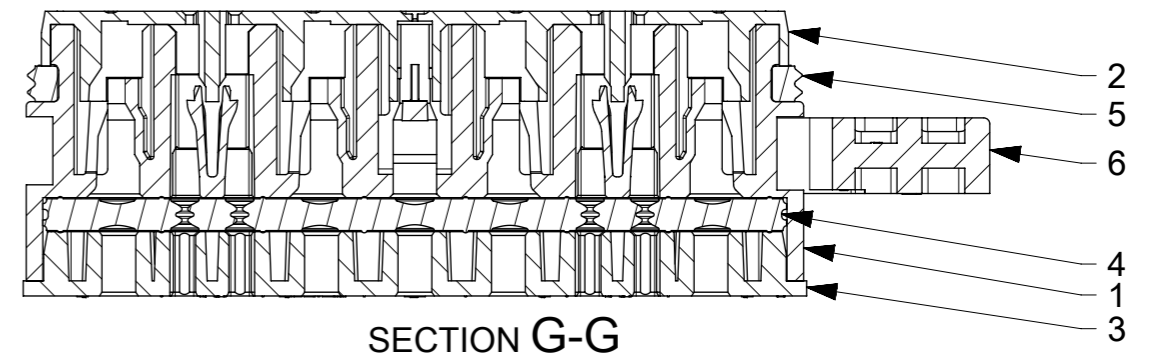
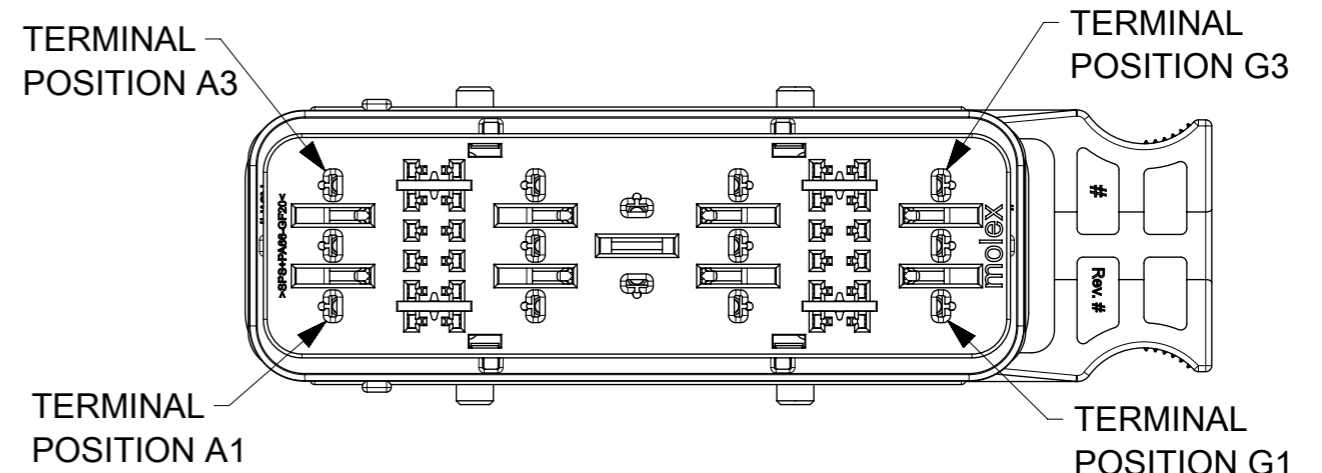
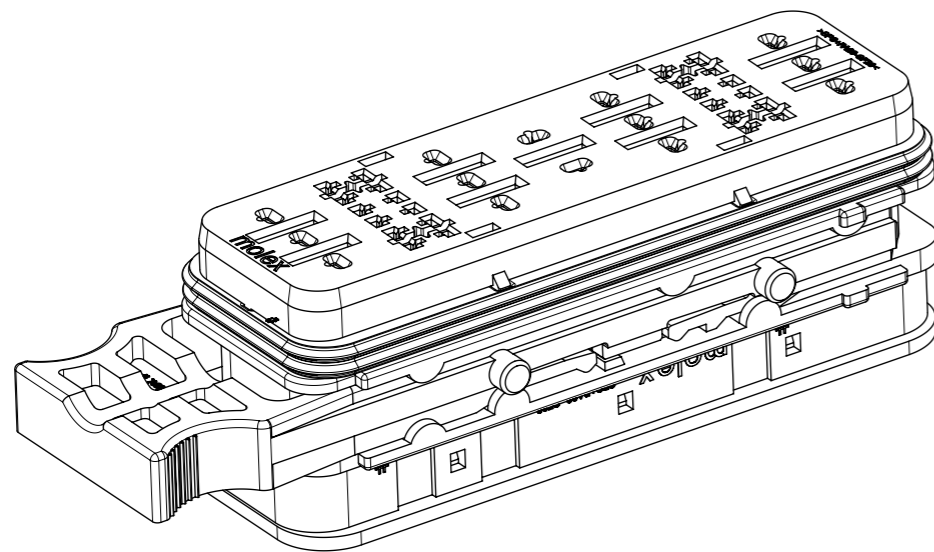

| | | | | | | | | | | | | |
|---|--|--|---------------------------------------|------------------------|-----------------|-----------------|--|----------------|--------------|--|--|--|
| THIS DRAWING CONTAINS INFORMATION THAT IS PROPRIETARY TO MOLEX ELECTRONIC TECHNOLOGIES, LLC AND SHOULD NOT BE USED WITHOUT WRITTEN PERMISSION | | | | | | | | | | | | |
| QUALITY SYMBOLS ▽ = 0 ▽ = 0 ▽ = 0 ▼ = 0 ▽ = 0 ⊗ = 0 ■ = 0 ▽ = 0 | EC NO: 102579 DRWN: AJOBRIEN CHK'D: SMCGREEVY APPR: JDWALLACE | 2016/01/21 2016/01/22 2016/01/26 | GENERAL TOLERANCES (UNLESS SPECIFIED) | | DIMENSION UNITS | SCALE | | | | | | |
| | | | ANGULAR TOL ± 0.5 ° | | MM | 1:1 | | | | | | |
| | | | 4 PLACES ± | | AJOBRIEN | 2016/01/21 | SRC MIXED POWER FEMALE RECEPTACLE HOUSING ASSEMBLY | | | | | |
| | | | 3 PLACES ± | | CHK'D BY | DATE | | | | | | |
| | | | 2 PLACES ± 0.2 | | SMCGREEVY | 2016/01/22 | PRODUCT CUSTOMER DRAWING | | | | | |
| 1 PLACE ± 0.5 | | APPR BY | DATE | | | | | | | | | |
| 0 PLACES ± | | JDWALLACE | 2016/01/26 | SERIES | MATERIAL NUMBER | CUSTOMER | | | | | | |
| DRAFT WHERE APPLICABLE MUST REMAIN WITHIN DIMENSIONS | | DRAWING SIZE A3 | | THIRD ANGLE PROJECTION | | 85084 | 850842414 | GENERAL MARKET | | | | |
| | | | | | | DOCUMENT NUMBER | DOC TYPE | DOC PART | SHEET NUMBER | | | |
| | | | | | | 850840700 | PSD | 000 | 5 OF 8 | | | |

NOTES:

1. SEE SHEET 1 FOR UNSPECIFIED NOTES AND DIMENSIONS
2. MX150 RECEPTACLE TERMINALS PER SD-33012-002 TO BE USED WITH THIS ASSEMBLY IN CAVITY D
CRIMPED WITH CABLE INSULATION OUTER DIAMETER IN THE RANGE 1.5mm TO 2.7mm
3. MX150L RECEPTACLE TERMINALS PER SD-19434-00* TO BE USED WITH THIS ASSEMBLY IN CAVITIES A, B, C, E, F & G
CRIMPED WITH CABLE INSULATION OUTER DIAMETER IN THE RANGE 3.0mm TO 5.0mm
4. MATES WITH: SRC 12+18ABCEFG POWER BLADE HOUSING ASSEMBLY PART NUMBER 937921218 PER 937921000 PSD

| No. | DESCRIPTION | QTY. | COLOUR |
|-----|--------------------|------|------------|
| 6 | SLIDING LATCH | 1 | BLACK |
| 5 | FEMALE FRONT SEAL | 1 | RED |
| 4 | FEMALE BACK SEAL | 1 | LIGHT BLUE |
| 3 | FEMALE REAR COVER | 1 | BLACK |
| 2 | FEMALE FRONT COVER | 1 | GREEN |
| 1 | FEMALE HOUSING | 1 | BLACK |

BILL OF MATERIAL

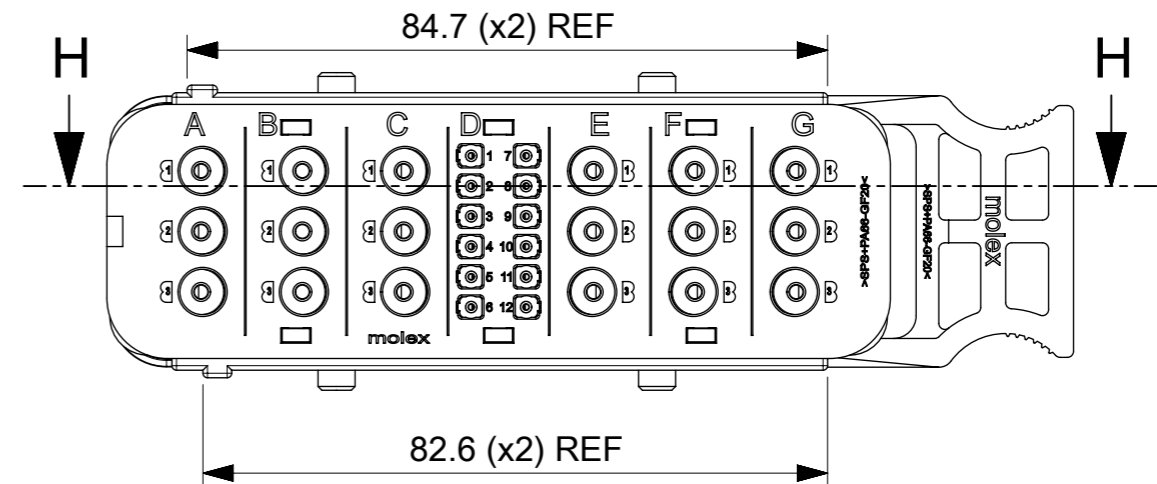
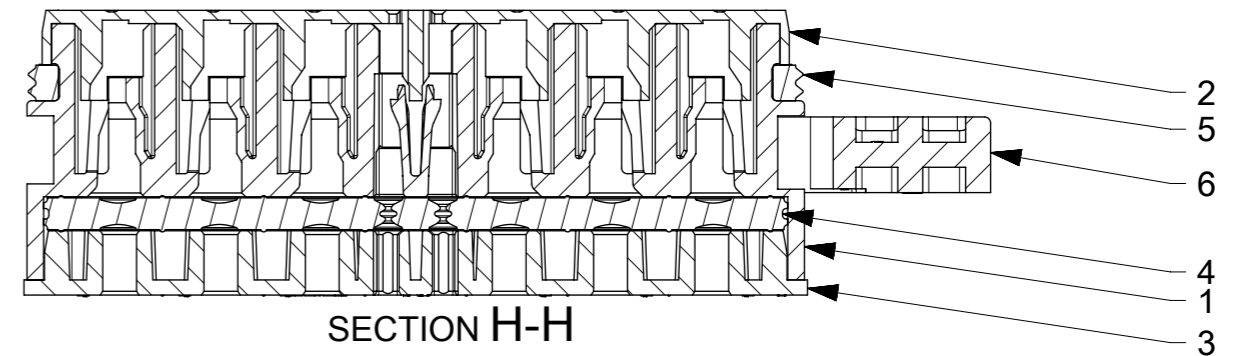
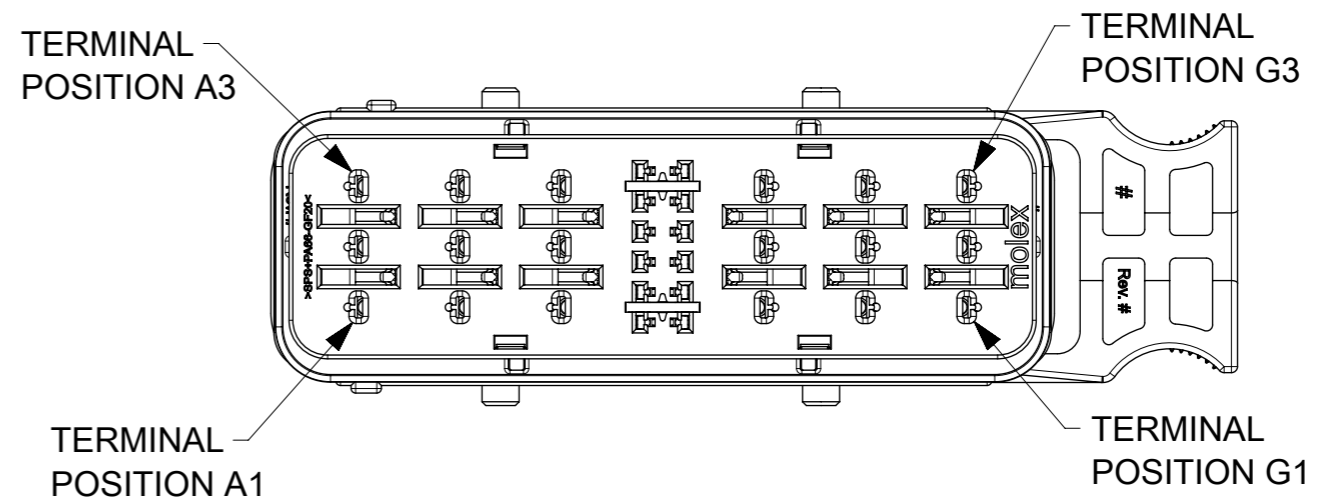
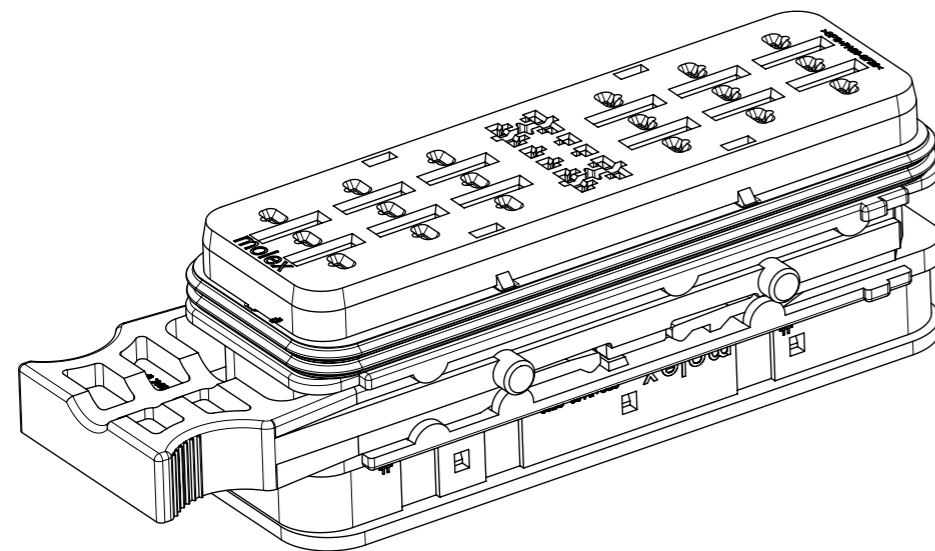

| QUALITY SYMBOLS | THIS DRAWING CONTAINS INFORMATION THAT IS PROPRIETARY TO MOLEX ELECTRONIC TECHNOLOGIES, LLC AND SHOULD NOT BE USED WITHOUT WRITTEN PERMISSION | | | | | | | | | | | | | |
|-----------------|---|--|---|--|--|---------------|-----------------|------------------------|-----------|--|--------------------------|--------------|--|------------|
| ▽A = 0 | EC NO: 102579 DRWN: AJOBRIEN CHK'D: SMCGREEVY APPR: JDWALLACE REV A | 2016/01/21 2016/01/22 2016/01/26 | GENERAL TOLERANCES (UNLESS SPECIFIED) | | DIMENSION UNITS | SCALE | | | | | | | | |
| ▽E = 0 | | | ANGULAR TOL ± 0.5 ° | | MM | 1:1 | | | | | | | | |
| ▽F = 0 | | | 4 PLACES ± | 3 PLACES ± | DRWN BY | DATE | | | | | | | | |
| ▽ = 0 | | | REPLACE SD-85084-700 EC NO: 102579 DRWN: AJOBRIEN CHK'D: SMCGREEVY APPR: JDWALLACE REV A | 2016/01/21 2016/01/22 2016/01/26 | 2 PLACES ± 0.2 | 1 PLACE ± 0.5 | 0 PLACES ± | CHK'D BY | DATE | SRC MIXED POWER FEMALE RECEPTACLE HOUSING ASSEMBLY | | | | |
| ▽C = 0 | | | | | DRAFT WHERE APPLICABLE MUST REMAIN WITHIN DIMENSIONS | | DRWN BY | DATE | SMCGREEVY | | | | | 2016/01/22 |
| ▽B = 0 | | | | | DRAFT WHERE APPLICABLE MUST REMAIN WITHIN DIMENSIONS | | APPR BY | DATE | JDWALLACE | 2016/01/26 | PRODUCT CUSTOMER DRAWING | | | |
| ▽ = 0 | | | | | DRAFT WHERE APPLICABLE MUST REMAIN WITHIN DIMENSIONS | | DRAWING SIZE | THIRD ANGLE PROJECTION | A3 | | | | | |
| ▽ = 0 | | | DRAFT WHERE APPLICABLE MUST REMAIN WITHIN DIMENSIONS | | | | | | 85084 | 850841218 | GENERAL MARKET | | | |
| RELEASE STATUS | | | P1 | RELEASE DATE | 26.01.2016 | 09:47:49 | DOCUMENT NUMBER | | 850840700 | DOC TYPE | DOC PART | SHEET NUMBER | | |
| | | | | | | | | | PSD | 000 | 6 OF 8 | | | |

NOTES:

1. SEE SHEET 1 FOR UNSPECIFIED NOTES AND DIMENSIONS
2. MX150L RECEPTACLE TERMINALS PER SD-19434-00* TO BE USED WITH THIS ASSEMBLY IN ALL CAVITIES CRIMPED WITH CABLE INSULATION OUTER DIAMETER IN THE RANGE 3.0mm TO 5.0mm
3. MATES WITH: SRC 0+20ABCDEF G POWER BLADE HOUSING ASSEMBLY PART NUMBER 937920020 PER 937921000 PSD

| 6 | SLIDING LATCH | 1 | BLACK |
|------------------|--------------------|------|------------|
| 5 | FEMALE FRONT SEAL | 1 | RED |
| 4 | FEMALE BACK SEAL | 1 | LIGHT BLUE |
| 3 | FEMALE REAR COVER | 1 | BLACK |
| 2 | FEMALE FRONT COVER | 1 | GREEN |
| 1 | FEMALE HOUSING | 1 | BLACK |
| No. | DESCRIPTION | QTY. | COLOUR |
| BILL OF MATERIAL | | | |

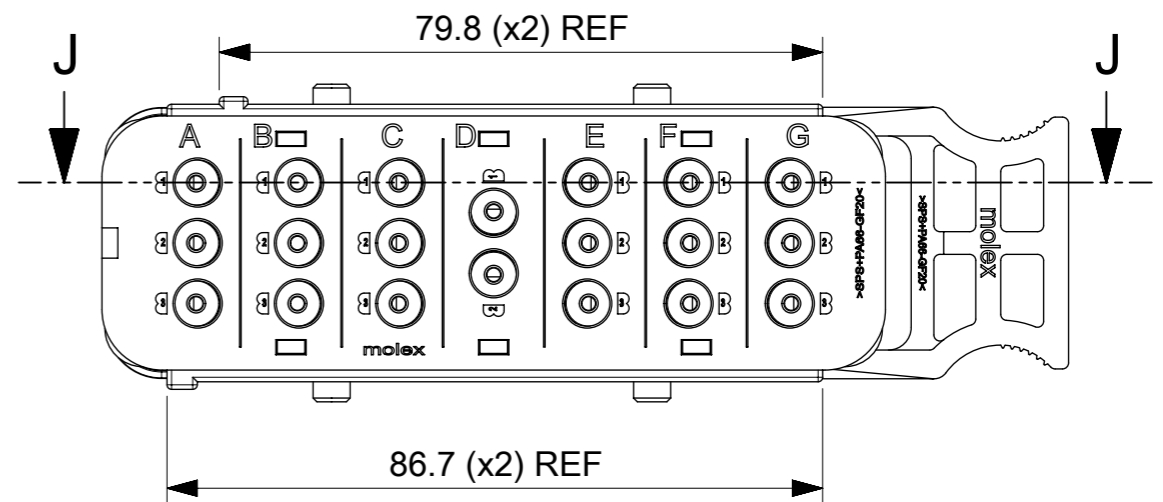
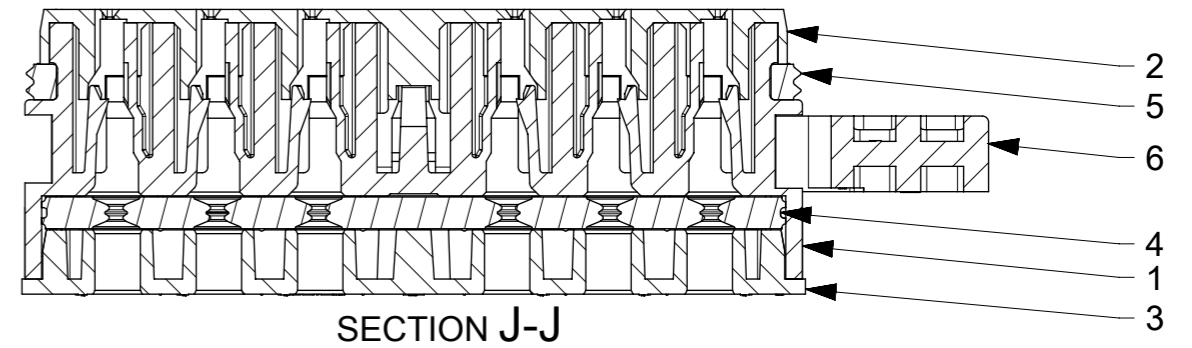
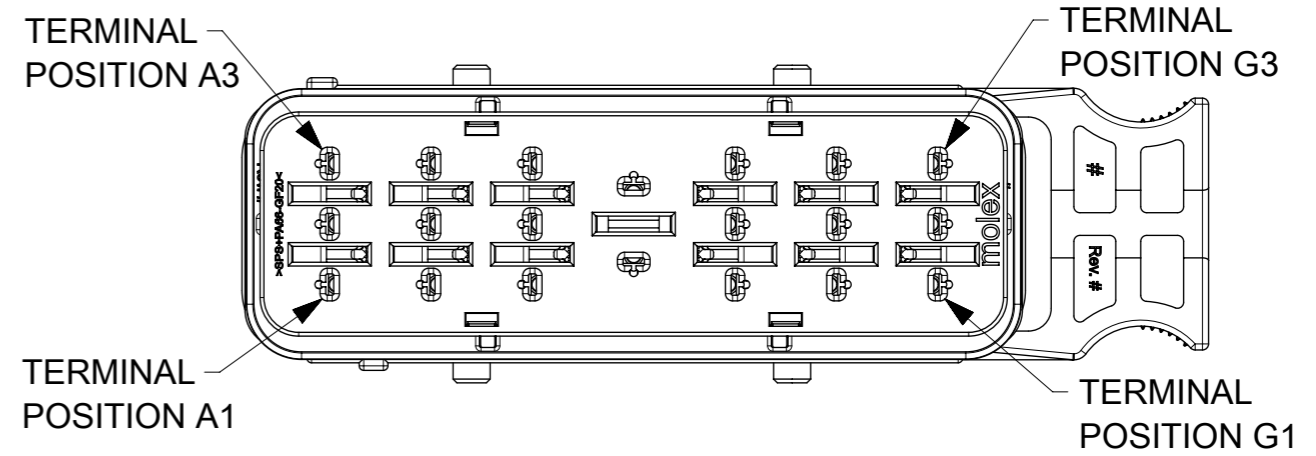
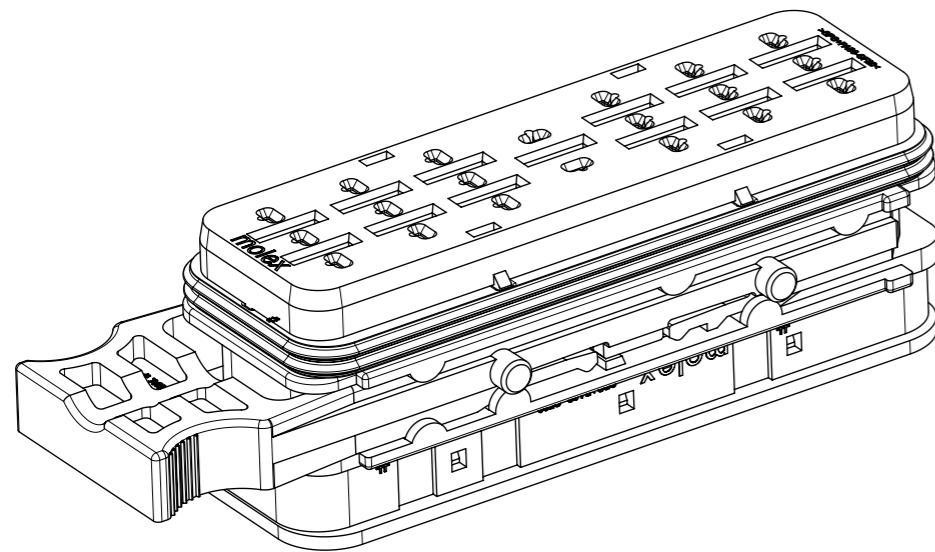

| | | | | | | | | | | |
|---|--|--|--|--|-----------------|------------------------|--|--------------------------|----------------|--------------|
| THIS DRAWING CONTAINS INFORMATION THAT IS PROPRIETARY TO MOLEX ELECTRONIC TECHNOLOGIES, LLC AND SHOULD NOT BE USED WITHOUT WRITTEN PERMISSION | | | | | | | | | | |
| QUALITY SYMBOLS ▽ = 0 ▽ = 0 ▽ = 0 ▼ = 0 ▽ = 0 ⊗ = 0 ■ = 0 ▽ = 0 | EC NO: 102579 DRWN: AJOBRIEN CHK'D: SMCGREEVY APPR: JDWALLACE | 2016/01/21 2016/01/22 2016/01/26 | GENERAL TOLERANCES (UNLESS SPECIFIED) ANGULAR TOL ± 0.5 ° | | DIMENSION UNITS | SCALE | | | | |
| | | | MM | 1:1 | DRWN BY | DATE | | | | |
| REPLACE SD-85084-700 | | | 4 PLACES ± | 3 PLACES ± | AJOBRIEN | 2016/01/21 | SRC MIXED POWER FEMALE RECEPTACLE HOUSING ASSEMBLY | | | |
| EC NO: 102579 DRWN: AJOBRIEN CHK'D: SMCGREEVY APPR: JDWALLACE | | | 2 PLACES ± 0.2 | 1 PLACE ± 0.5 | CHK'D BY | DATE | | | | |
| EC NO: 102579 DRWN: AJOBRIEN CHK'D: SMCGREEVY APPR: JDWALLACE | | | 0 PLACES ± | DRAFT WHERE APPLICABLE MUST REMAIN WITHIN DIMENSIONS | | SMCGREEVY | 2016/01/22 | PRODUCT CUSTOMER DRAWING | | |
| EC NO: 102579 DRWN: AJOBRIEN CHK'D: SMCGREEVY APPR: JDWALLACE | | | DRAFT WHERE APPLICABLE MUST REMAIN WITHIN DIMENSIONS | | APPR BY | DATE | | | | |
| EC NO: 102579 DRWN: AJOBRIEN CHK'D: SMCGREEVY APPR: JDWALLACE | | | DRAFT WHERE APPLICABLE MUST REMAIN WITHIN DIMENSIONS | | JDWALLACE | 2016/01/26 | SERIES | MATERIAL NUMBER | CUSTOMER | |
| EC NO: 102579 DRWN: AJOBRIEN CHK'D: SMCGREEVY APPR: JDWALLACE | | | DRAFT WHERE APPLICABLE MUST REMAIN WITHIN DIMENSIONS | | DRAWING SIZE | THIRD ANGLE PROJECTION | 85084 | 850840020 | GENERAL MARKET | |
| EC NO: 102579 DRWN: AJOBRIEN CHK'D: SMCGREEVY APPR: JDWALLACE | | | DRAFT WHERE APPLICABLE MUST REMAIN WITHIN DIMENSIONS | | A3 | | DOCUMENT NUMBER | DOC TYPE | DOC PART | SHEET NUMBER |
| EC NO: 102579 DRWN: AJOBRIEN CHK'D: SMCGREEVY APPR: JDWALLACE | | | DRAFT WHERE APPLICABLE MUST REMAIN WITHIN DIMENSIONS | | | | 850840700 | PSD | 000 | 7 OF 8 |

NOTES:

- SEE SHEET 1 FOR UNSPECIFIED NOTES AND DIMENSIONS
- MX150 RECEPTACLE TERMINALS PER SD-33012-002 TO BE USED WITH THIS ASSEMBLY IN CAVITIES C, D & E, CRIMPED WITH CABLE INSULATION OUTER DIAMETER IN THE RANGE 1.5mm TO 2.7mm
- SRC RECEPTACLE TERMINALS PER 936430010 PSD MAY BE USED WITH THIS ASSEMBLY IN CAVITIES B & F CRIMPED WITH 2.5mm² (13AWG) CABLE INSULATION OUTER DIAMETER IN THE RANGE 2.7mm TO 3.0mm
- MX150L RECEPTACLE TERMINALS PER SD-19434-00* TO BE USED WITH THIS ASSEMBLY IN CAVITIES A & G CRIMPED WITH CABLE INSULATION OUTER DIAMETER IN THE RANGE 3.0mm TO 5.0mm
- MATES WITH: SRC 60+6AG POWER 2.5 BLADE HOUSING ASSEMBLY PART NUMBER 850836025 PER 850830300 PSD OR 937926025 PER 937921000 PSD

| 6 | SLIDING LATCH | 1 | BLACK |
|-----|--------------------|------|------------|
| 5 | FEMALE FRONT SEAL | 1 | RED |
| 4 | FEMALE BACK SEAL | 1 | LIGHT BLUE |
| 3 | FEMALE REAR COVER | 1 | BLACK |
| 2 | FEMALE FRONT COVER | 1 | GREEN |
| 1 | FEMALE HOUSING | 1 | BLACK |
| No. | DESCRIPTION | QTY. | COLOUR |

BILL OF MATERIAL

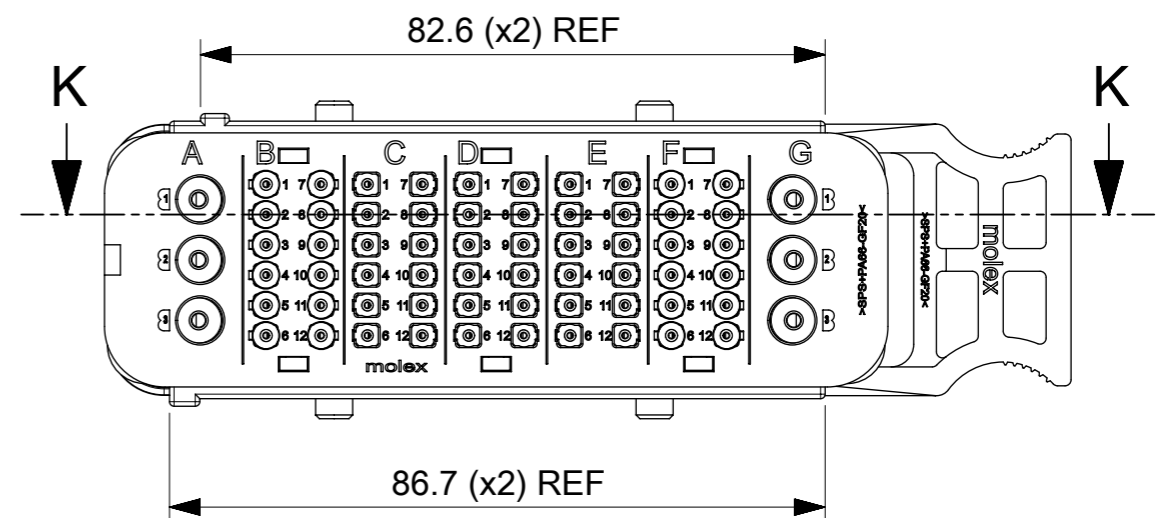
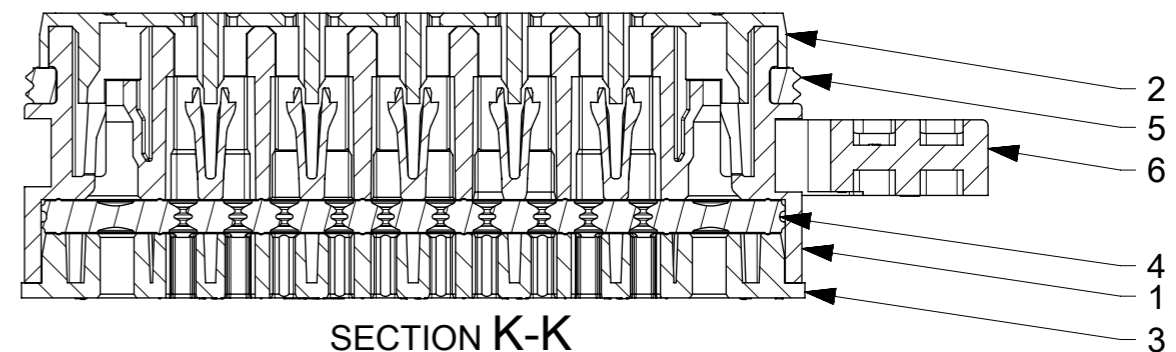
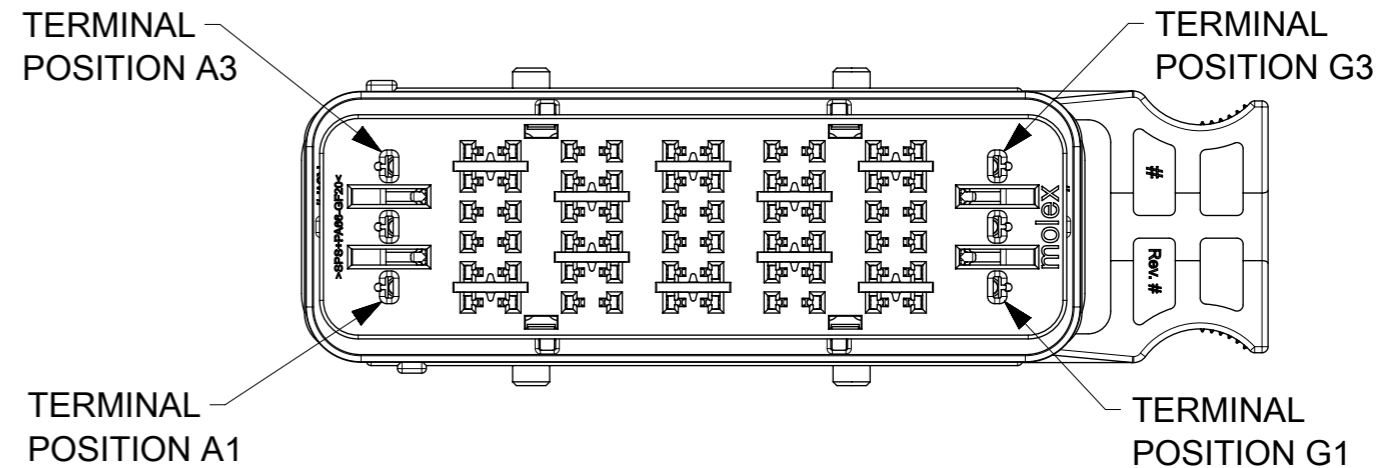
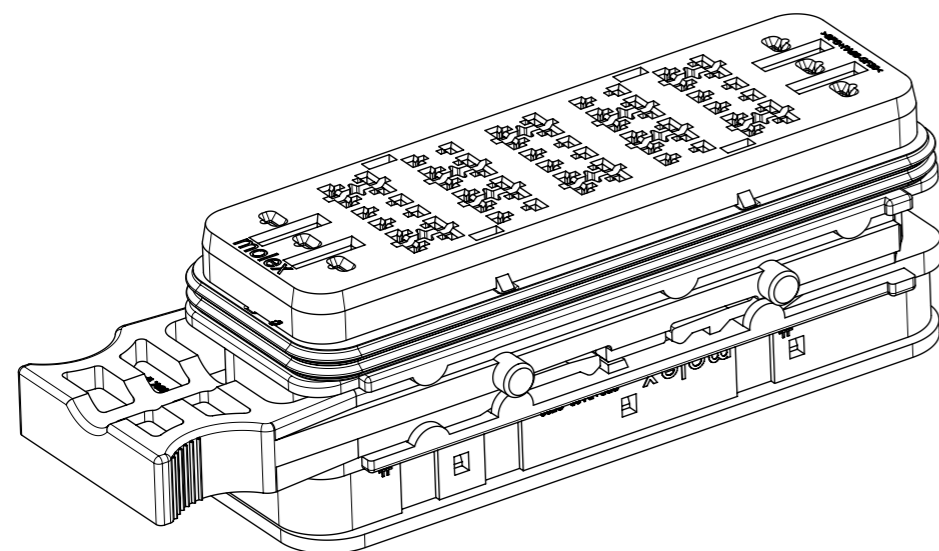

| | | | | | | | | | | | | | | | |
|---|----------------------|---------------|----------------|------------------|-----------------|------------|------------|--|---------------------------------------|--------------|------------------------|--------------------------|--|----------------|--------------|
| THIS DRAWING CONTAINS INFORMATION THAT IS PROPRIETARY TO MOLEX ELECTRONIC TECHNOLOGIES, LLC AND SHOULD NOT BE USED WITHOUT WRITTEN PERMISSION | | | | | | | | | | | | | | | |
| QUALITY SYMBOLS | REPLACE SD-85084-700 | EC NO: 102579 | DRWN: AJOBRIEN | CHK'D: SMCGREEVY | APPR: JDWALLACE | 2016/01/21 | 2016/01/22 | 2016/01/26 | GENERAL TOLERANCES (UNLESS SPECIFIED) | | DIMENSION UNITS | SCALE | | | |
| | | | | | | | | | ANGULAR TOL ± 0.5 ° | | MM | 1:1 | | | |
| ▽A = 0 | | | | | | | | | 4 PLACES | ± | DRWN BY | DATE | SRC MIXED POWER FEMALE RECEPTACLE HOUSING ASSEMBLY | | |
| ▽E = 0 | | | | | | | | 3 PLACES | ± | AJOBRIEN | 2016/01/21 | PRODUCT CUSTOMER DRAWING | | | |
| ▽F = 0 | | | | | | | | 2 PLACES | ± 0.2 | CHK'D BY | DATE | | | | SERIES |
| ▽ = 0 | | | | | | | | 1 PLACE | ± 0.5 | SMCGREEVY | 2016/01/22 | 85084 | 850846025 | GENERAL MARKET | |
| ▽C = 0 | | | | | | | | 0 PLACES | ± | APPR BY | DATE | DOCUMENT NUMBER | DOC TYPE | DOC PART | SHEET NUMBER |
| ⊗ = 0 | | | | | | | | DRAFT WHERE APPLICABLE MUST REMAIN WITHIN DIMENSIONS | | JDWALLACE | 2016/01/26 | 850840700 | PSD | 000 | 8 OF 8 |
| ■ = 0 | | | | | | | | | | DRAWING SIZE | THIRD ANGLE PROJECTION | | | | |
| ▽ = 0 | | | | | | | | | | A3 | | | | | |