

NUMBER C-175151



METRIC

単位: mm DIMENSIONS IN MM. DO NOT SCALE PRINT

PRINT DIST

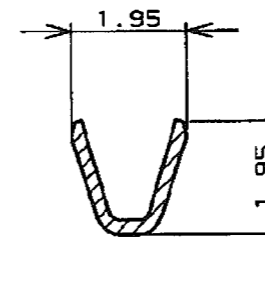
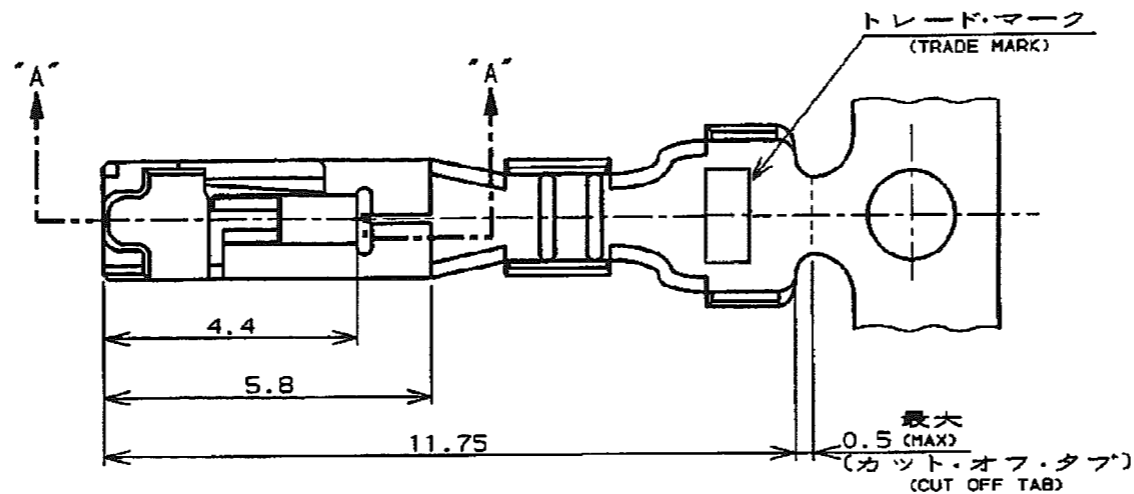

断面 "D" - "D" (SECT)

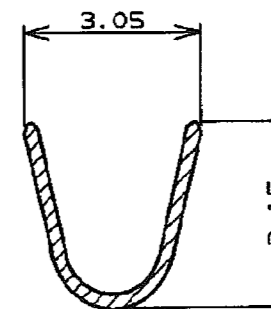

断面 "E" - "E" (SECT)

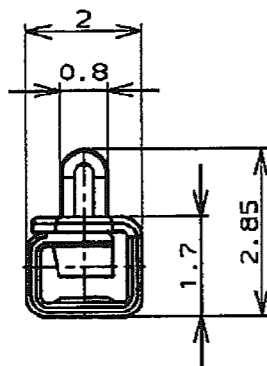

断面 "B" - "B" (SECT)

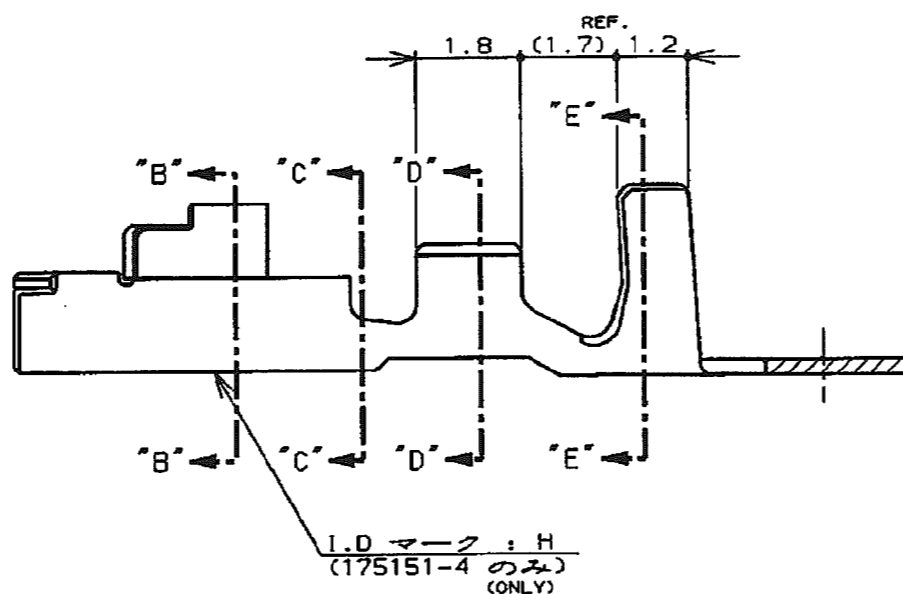

断面 "A" - "A" (SECT) (175151-1, -2)

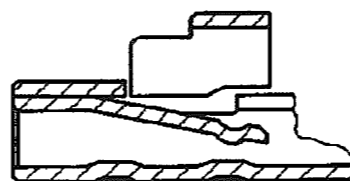

断面 "A" - "A" (SECT) (175151-4)

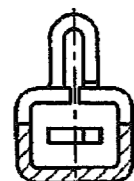

断面 "C" - "C" (SECT)

注記:

- 1. 適用規格
 - 製品規格 : 108-5302
 - 取付適用規格 : 114-5142
- 2. 取扱説明書 : IS-503J

NOTES:

- 1. APPLICABLE SPEC
 - PRODUCT SPEC : 108-5302
 - APPLICATION SPEC : 114-5142
- 2. INSTRUTION SHEET : IS-503J

	NYE: 502H-20-UV 1L7"リカットオイル処理 (APPLIED LUBRICANT OIL)	錫めつき黄銅 (PRE TINNED BRASS)	175151-5
175155-4	---	錫めつき黄銅合金 (PRE TINNED COPPER ALLOY)	175151-4
175155-2	---	錫めつき黄銅 (PRE TINNED BRASS)	175151-2
175155-1	---	錫めつき黄銅合金 (PRE TINNED COPPER ALLOY)	175151-1
バラ状端子型番 (L.P P/N)	仕上 (FINISH)	材料 (MATERIAL)	型番 (P/N)

F1	REVISED PER ECO-11-005030	RK	HMR	01APR11
LTR	変更 (REVISION RECORD)	DR	CHK	DATE

DR.	8. JUN '95	DE.	8. JUN '95
N. NAGASHIMA		M. SHINDO	
CHK.	8. JUN '95	APP.	8. JUN '95
M. SHINDO		Y. KASHIWA	

適合電線断面積 (WIRE RANGE)	0.12~0.35mm ² (AWG#26~22)	被覆外径 (INSULATION DIA.)	1.2~2 mmφ	名称 (NAME)	リセパクル・コンタクト, アンパ・ユニバーサル・パワー・コネクタ (REC CONTACT AMP UNIVERSAL POWER CONN.)
材料 (MATERIAL) 表参照 (SEE TABLE)		仕上 (FINISH) 表参照 (SEE TABLE)		一般公差 (GENERAL TOLERANCE)	10以下: ±0.2 10~30以下: ±0.25 30~100以下: ±0.3 角 度: ±3°
F1		LOC	B J	番号 (No.)	C-175151
LTR		尺度 (SCALE)	---	REV.	F1
				SHEET	1 OF 1

(CUSTOMER DRAWING) 参 考 区 画