

GenX3™ 600V IGBT w/ SiC Anti-Parallel Diode

IXGH48N60C3C1

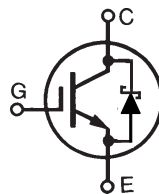

High Speed PT IGBT for
40 - 100kHz Switching

$$\begin{aligned}
 V_{CES} &= 600V \\
 I_{C110} &= 48A \\
 V_{CE(sat)} &\leq 2.5V \\
 t_{fi(typ)} &= 38ns
 \end{aligned}$$

Symbol	Test Conditions	Maximum Ratings	
V_{CES}	$T_J = 25^\circ\text{C}$ to 150°C	600	V
V_{CGR}	$T_J = 25^\circ\text{C}$ to 150°C , $R_{GE} = 1M\Omega$	600	V
V_{GES}	Continuous	± 20	V
V_{GEM}	Transient	± 30	V
I_{C25}	$T_C = 25^\circ\text{C}$ (Limited by Leads)	75	A
I_{C110}	$T_C = 110^\circ\text{C}$	48	A
I_{F110}	$T_C = 110^\circ\text{C}$	20	A
I_{CM}	$T_C = 25^\circ\text{C}$, 1ms	250	A
I_A	$T_C = 25^\circ\text{C}$	30	A
E_{AS}	$T_C = 25^\circ\text{C}$	300	mJ
SSOA (RBSOA)	$V_{GE} = 15V$, $T_{VJ} = 125^\circ\text{C}$, $R_G = 3\Omega$ Clamped Inductive Load	$I_{CM} = 100$ @ $\leq V_{CES}$	A
P_C	$T_C = 25^\circ\text{C}$	300	W
T_J		-55 ... +150	$^\circ\text{C}$
T_{JM}		150	$^\circ\text{C}$
T_{stg}		-55 ... +150	$^\circ\text{C}$
T_L	1.6mm (0.062 in.) from Case for 10s	300	$^\circ\text{C}$
T_{SOLD}	Plastic Body for 10 Seconds	260	$^\circ\text{C}$
F_C	Mounting Torque	1.13/10	Nm/lb.in
Weight		6	g

TO-247

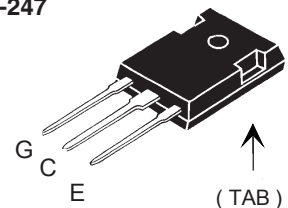

G = Gate C = Collector
E = Emitter TAB = Collector

Features

- Optimized for Low Switching Losses
- Square RBSOA
- Anti-Parallel Schottky Diode
- Fast Switching
- Avalanche Rated
- International Standard Package

Advantages

- High Power Density
- Low Gate Drive Requirement

Applications

- High Frequency Power Inverters
- UPS
- Motor Drives
- SMPS
- PFC Circuits
- Battery Chargers
- Welding Machines
- Lamp Ballasts

Symbol	Test Conditions ($T_J = 25^\circ\text{C}$, Unless Otherwise Specified)	Characteristic Values		
		Min.	Typ.	Max.
$V_{GE(th)}$	$I_C = 250\mu\text{A}$, $V_{CE} = V_{GE}$	3.0		5.5 V
I_{CES}	$V_{CE} = V_{CES}$, $V_{GE} = 0V$ $T_J = 125^\circ\text{C}$			50 μA 1.75 mA
I_{GES}	$V_{CE} = 0V$, $V_{GE} = \pm 20V$			± 100 nA
$V_{CE(sat)}$	$I_C = 30A$, $V_{GE} = 15V$, Note 1 $T_J = 125^\circ\text{C}$		2.3 1.8	2.5 V V

Symbol	Test Conditions ($T_J = 25^\circ\text{C}$, Unless Otherwise Specified)	Characteristic Values		
		Min.	Typ.	Max.
g_{fs}	$I_C = 30\text{A}, V_{CE} = 10\text{V}$, Note 1	20	30	S
C_{ies}	$V_{CE} = 25\text{V}, V_{GE} = 0\text{V}, f = 1\text{MHz}$		2120	pF
C_{oes}			420	pF
C_{res}			50	pF
Q_g	$I_C = 30\text{A}, V_{GE} = 15\text{V}, V_{CE} = 0.5 \cdot V_{CES}$		77	nC
Q_{ge}			16	nC
Q_{gc}			32	nC
$t_{d(on)}$	Inductive Load, $T_J = 25^\circ\text{C}$ $I_C = 30\text{A}, V_{GE} = 15\text{V}$ $V_{CE} = 400\text{V}, R_G = 3\Omega$ Note 2		19	ns
t_{ri}			25	ns
E_{on}			0.33	mJ
$t_{d(off)}$			60	100 ns
t_{fi}			38	ns
E_{off}			0.23	0.42 mJ
$t_{d(on)}$	Inductive Load, $T_J = 125^\circ\text{C}$ $I_C = 30\text{A}, V_{GE} = 15\text{V}$ $V_{CE} = 400\text{V}, R_G = 3\Omega$ Note 2		19	ns
t_{ri}			28	ns
E_{on}			0.37	mJ
$t_{d(off)}$			92	ns
t_{fi}			95	ns
E_{off}			0.57	mJ
R_{thJC}			0.42	$^\circ\text{C/W}$
R_{thCS}		0.21		$^\circ\text{C/W}$

TO-247 AD Outline

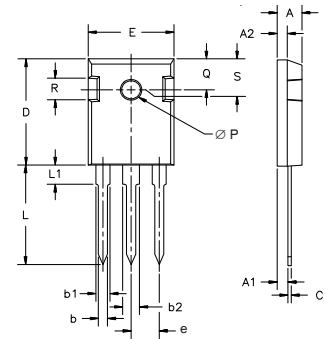

Dim.	Millimeter		Inches	
	Min.	Max.	Min.	Max.
A	4.7	5.3	.185	.209
A ₁	2.2	2.54	.087	.102
A ₂	2.2	2.6	.087	.102
b	1.0	1.4	.040	.055
b ₁	1.65	2.13	.065	.084
b ₂	2.87	3.12	.113	.123
C	.4	.8	.016	.031
D	20.80	21.46	.819	.845
E	15.75	16.26	.610	.640
e	5.20	5.72	0.205	0.225
L	19.81	20.32	.780	.800
L1		4.50		.177
∅P	3.55	3.65	.140	.144
Q	5.89	6.40	0.232	0.252
R	4.32	5.49	.170	.216

Reverse Diode (SiC)

Symbol	Test Conditions ($T_J = 25^\circ\text{C}$, Unless Otherwise Specified)	Characteristic Values		
		Min.	Typ.	Max.
V_F	$I_F = 20\text{A}, V_{GE} = 0\text{V}$, Note 1 $T_J = 125^\circ\text{C}$		1.65 1.80	V V
R_{thJC}				0.90 $^\circ\text{C/W}$

Notes

1. Pulse test, $t \leq 300\mu\text{s}$, duty cycle, $d \leq 2\%$.
2. Switching times & energy losses may increase for higher V_{CE} (Clamp), T_J or R_G .

PRELIMINARY TECHNICAL INFORMATION

The product presented herein is under development. The Technical Specifications offered are derived from data gathered during objective characterizations of preliminary engineering lots; but also may yet contain some information supplied during a pre-production design evaluation. IXYS reserves the right to change limits, test conditions, and dimensions without notice.

IXYS Reserves the Right to Change Limits, Test Conditions, and Dimensions.

IXYS MOSFETs and IGBTs are covered by one or more of the following U.S. patents:	4,835,592	4,931,844	5,049,961	5,237,481	6,162,665	6,404,065 B1	6,683,344	6,727,585	7,005,734 B2	7,157,338 B2
	4,850,072	5,017,508	5,063,307	5,381,025	6,259,123 B1	6,534,343	6,710,405 B2	6,759,692	7,063,975 B2	
	4,881,106	5,034,796	5,187,117	5,486,715	6,306,728 B1	6,583,505	6,710,463	6,771,478 B2	7,071,537	

Fig. 1. Output Characteristics @ 25°C

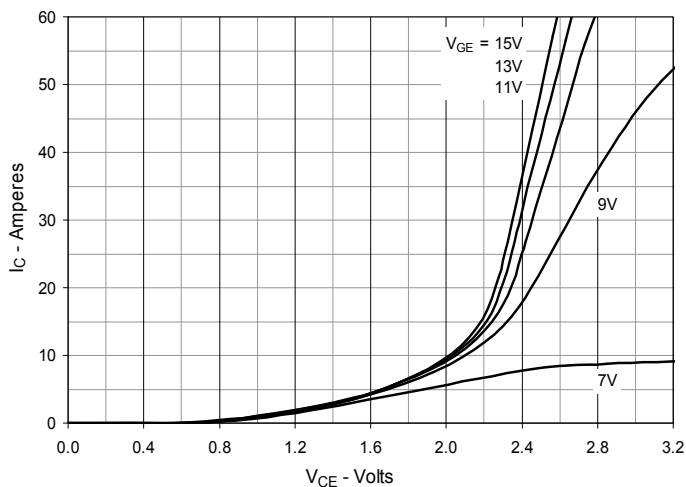

Fig. 2. Extended Output Characteristics @ 25°C

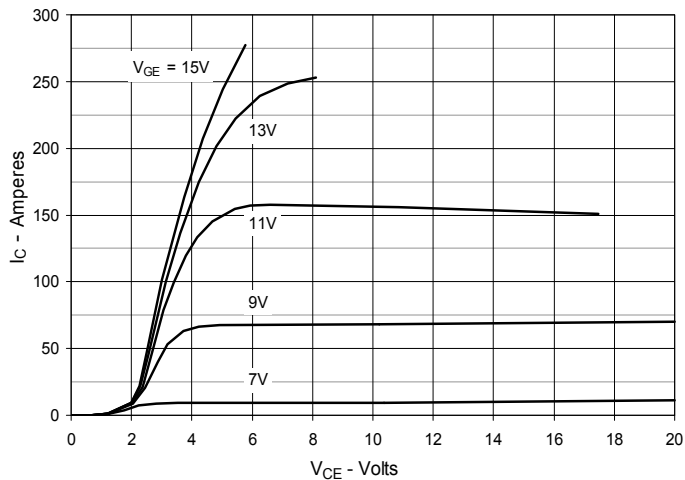

Fig. 3. Output Characteristics @ 125°C

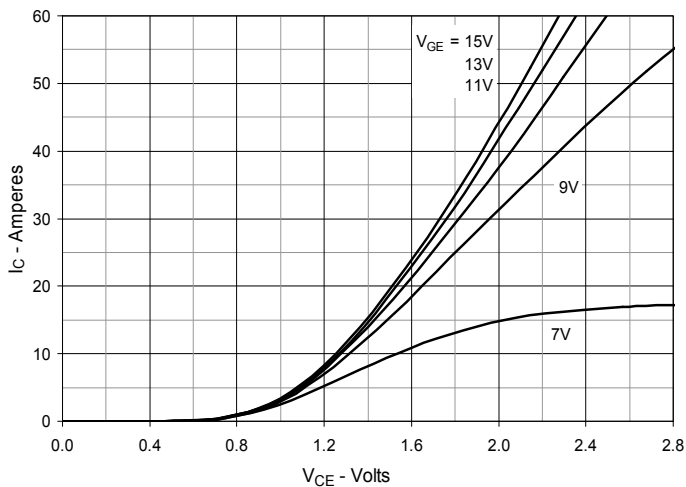

Fig. 4. Dependence of $V_{CE(sat)}$ on Junction Temperature

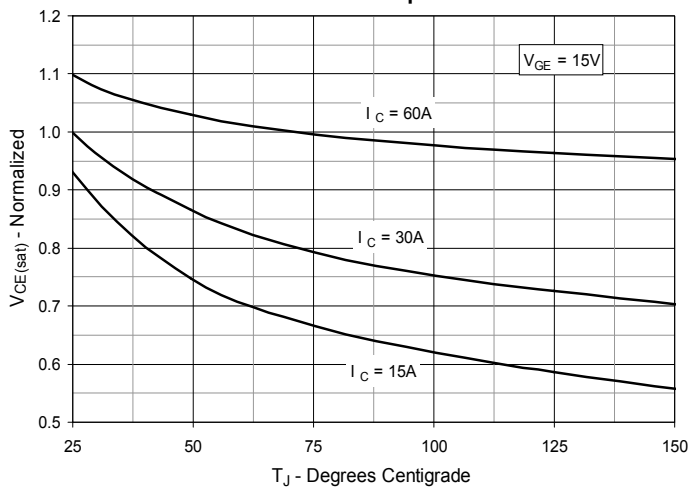

Fig. 5. Collector-to-Emitter Voltage vs. Gate-to-Emitter Voltage

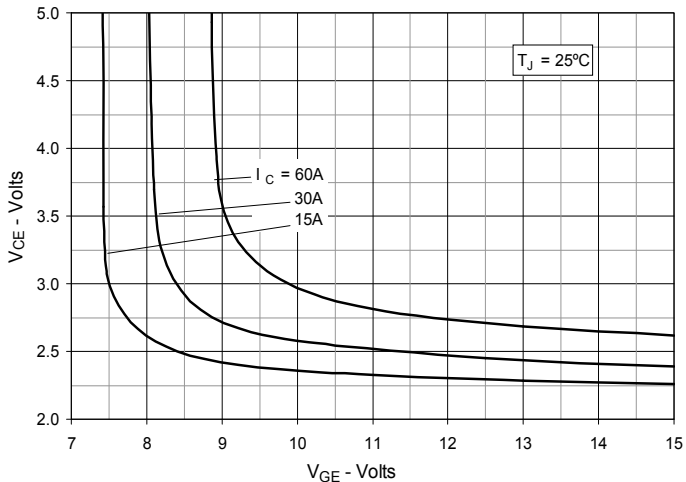

Fig. 6. Input Admittance

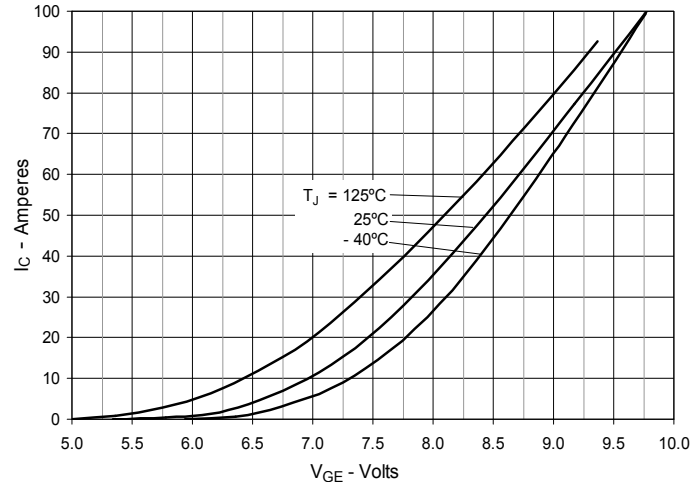

Fig. 7. Transconductance

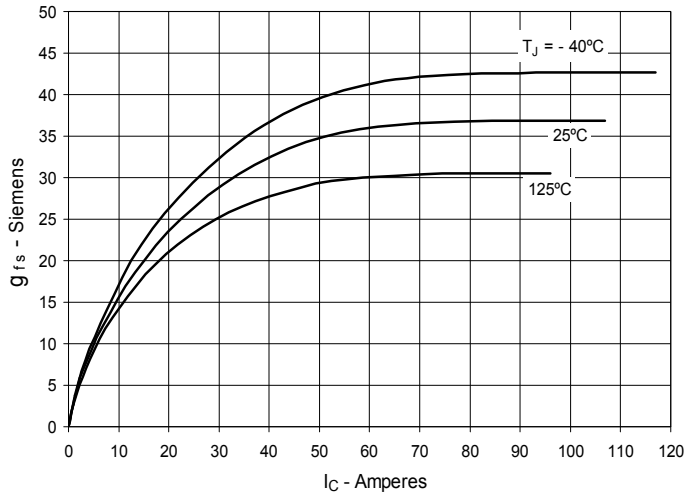

Fig. 8. Gate Charge

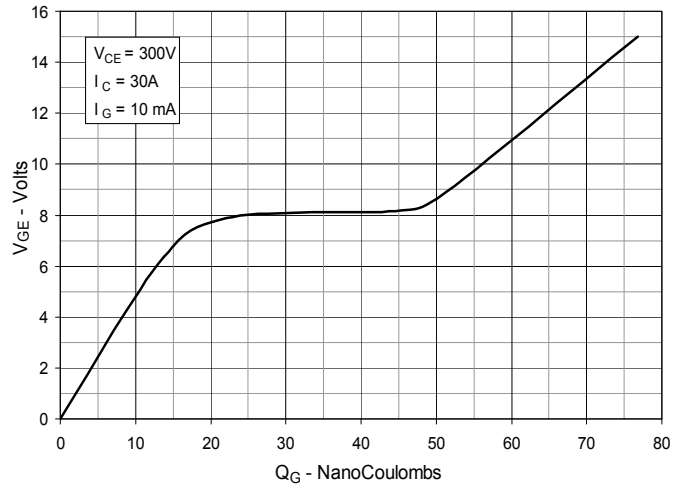

Fig. 9. Capacitance

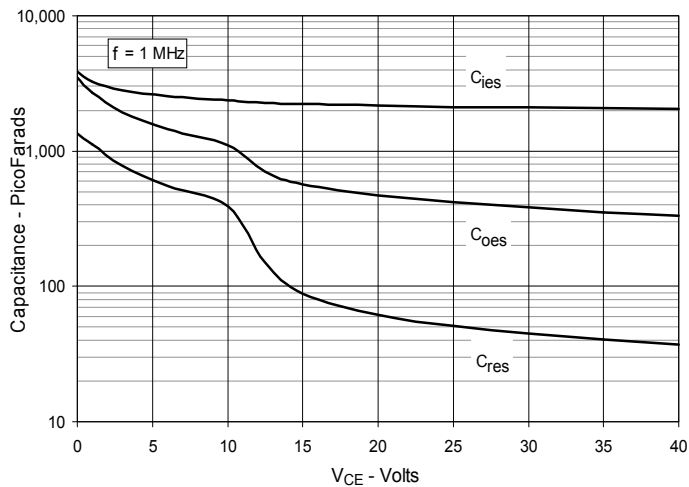

Fig. 10. Reverse-Bias Safe Operating Area

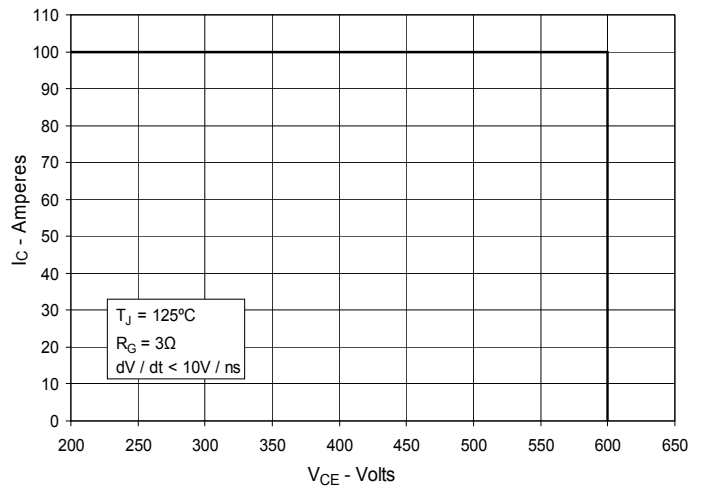
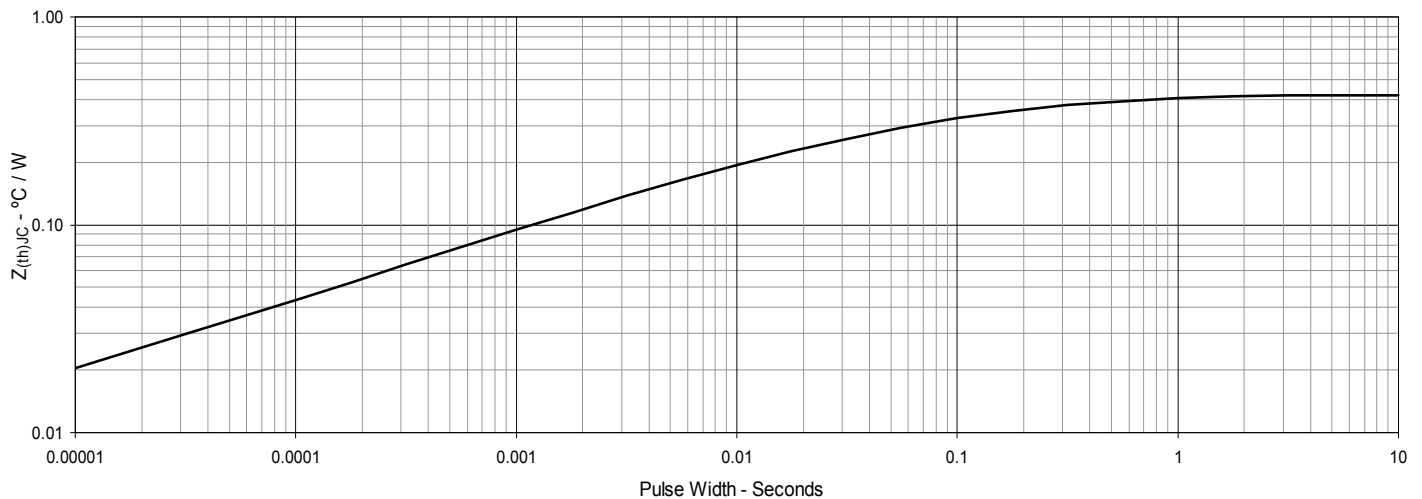
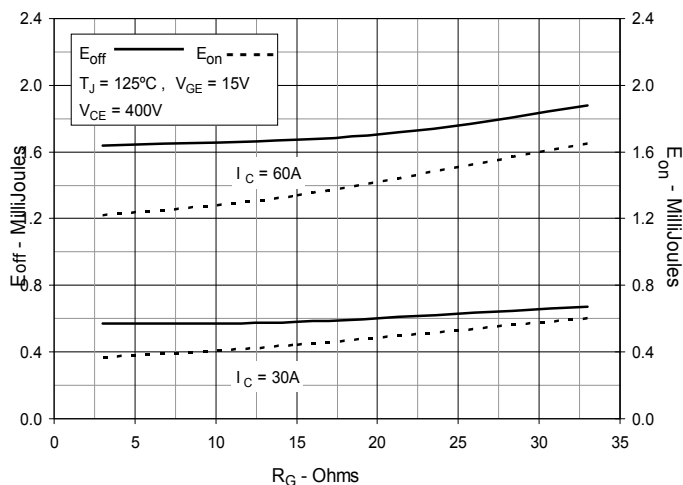
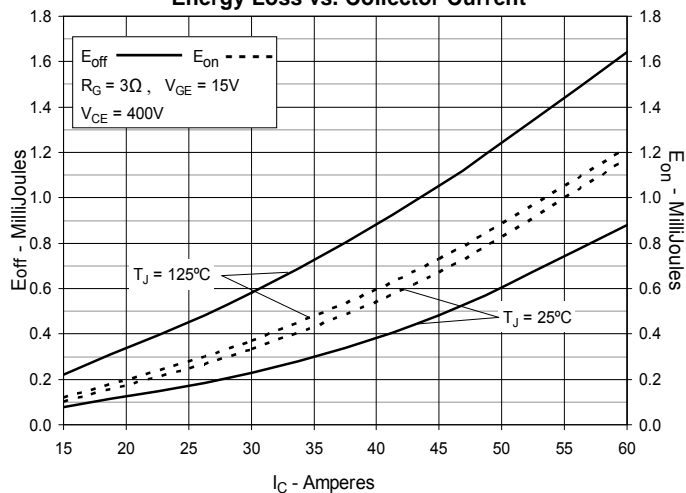
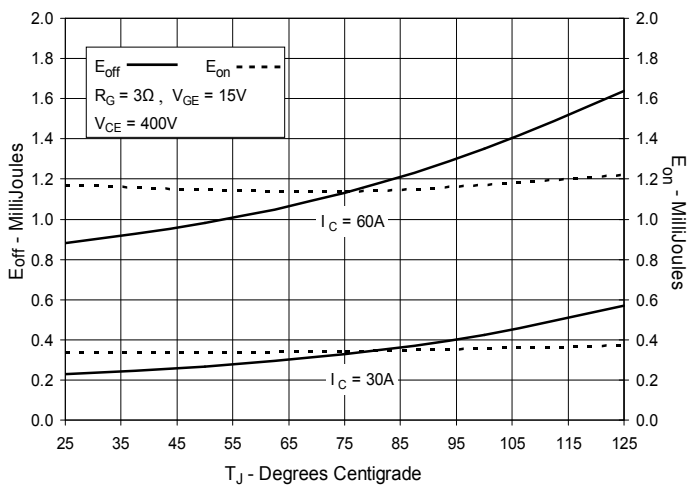
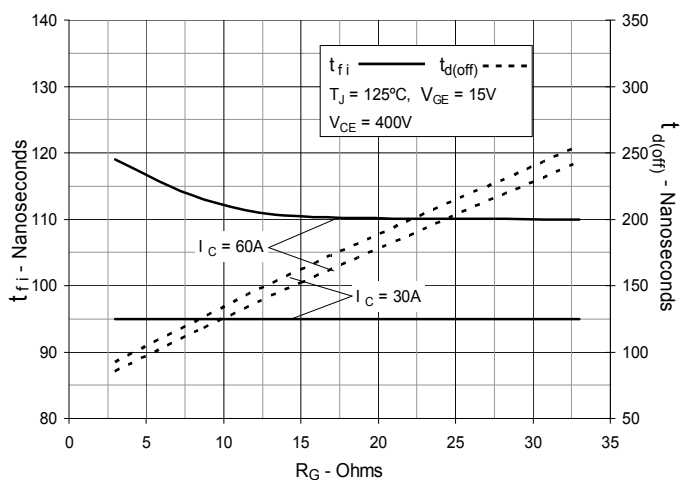
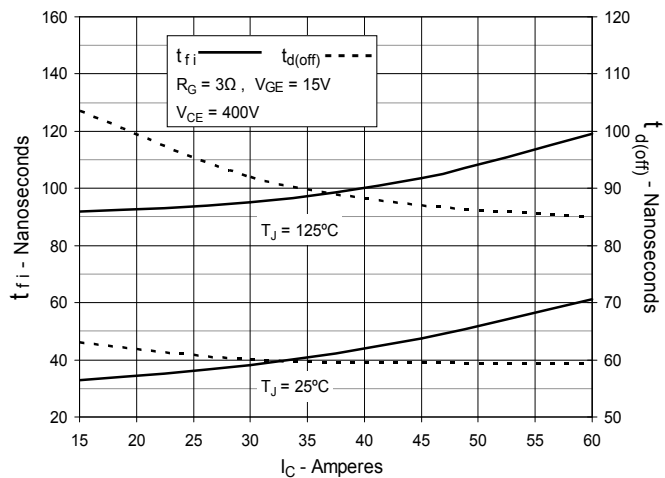
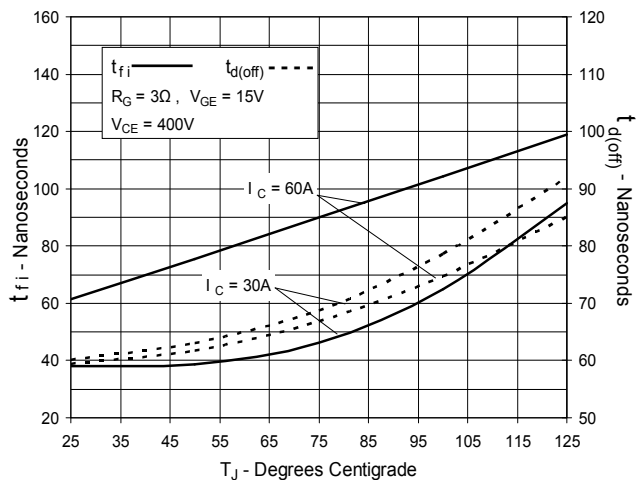
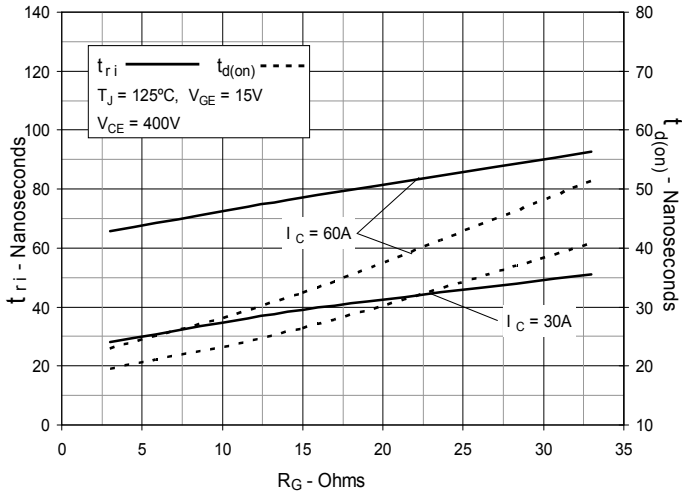

Fig. 11. Maximum Transient Thermal Impedance

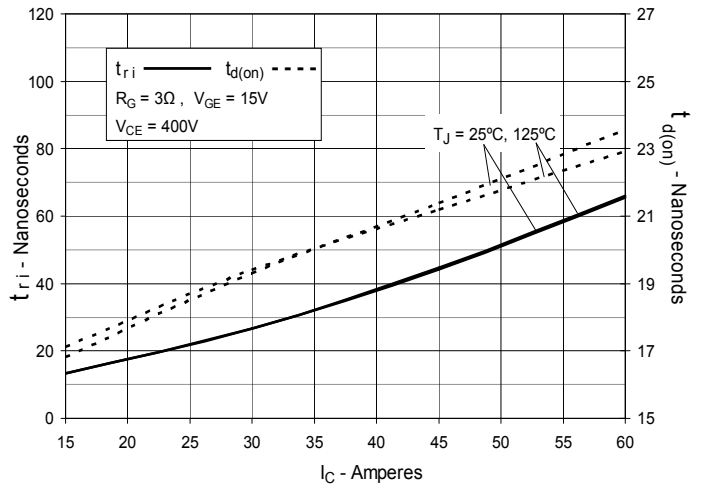

**Fig. 12. Inductive Switching
Energy Loss vs. Gate Resistance**

**Fig. 13. Inductive Switching
Energy Loss vs. Collector Current**

**Fig. 14. Inductive Switching
Energy Loss vs. Junction Temperature**

**Fig. 15. Inductive Turn-off
Switching Times vs. Gate Resistance**

**Fig. 16. Inductive Turn-off
Switching Times vs. Collector Current**

**Fig. 17. Inductive Turn-off
Switching Times vs. Junction Temperature**

**Fig. 18. Inductive Turn-on
Switching Times vs. Gate Resistance**



**Fig. 19. Inductive Turn-on
Switching Times vs. Collector Current**



**Fig. 20. Inductive Turn-on
Switching Times vs. Junction Temperature**

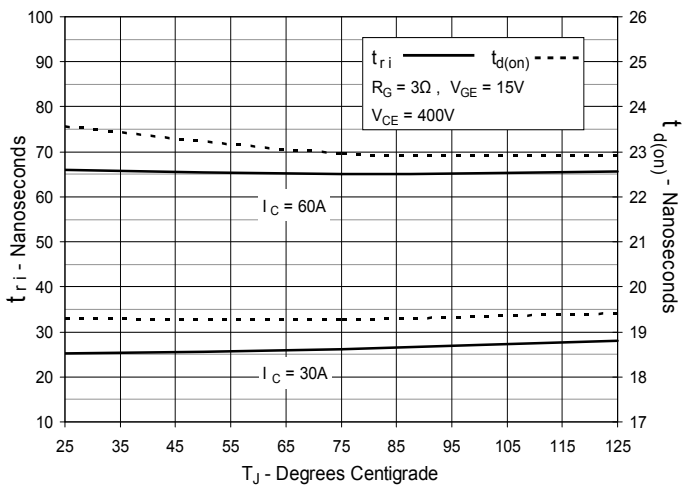

Fig. 21. Forward Current vs. Forward Voltage

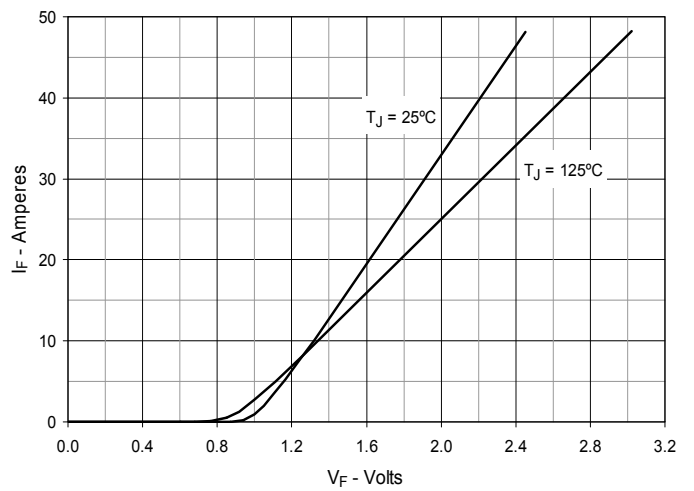

Fig. 22. Maximum Transient Thermal Impedance for Diode

