

IRG4BC10KPbF

INSULATED GATE BIPOLAR TRANSISTOR

Short Circuit Rated
UltraFast IGBT

Features

- Short Circuit Rated UltraFast: Optimized for high operating frequencies >5.0 kHz , and Short Circuit Rated to 10 μ s @ 125°C, V_{GE} = 15V
- Generation 4 IGBT design provides higher efficiency than Generation 3
- Industry standard TO-220AB package
- Lead-Free

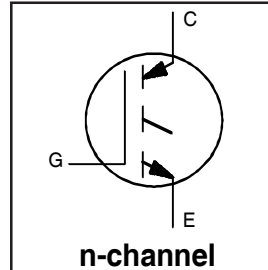

V _{CES} = 600V
V _{CE(on)} typ. = 2.39V
@ V _{GE} = 15V, I _C = 5.0A

Benefits

- Generation 4 IGBTs offer highest efficiency available
- IGBTs optimized for specified application conditions

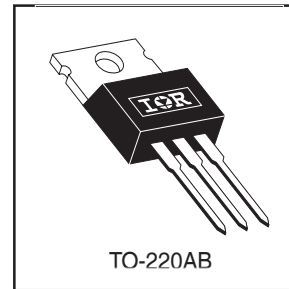

Absolute Maximum Ratings

	Parameter	Max.	Units
V _{CES}	Collector-to-Emitter Breakdown Voltage	600	V
I _C @ T _C = 25°C	Continuous Collector Current	9.0	A
I _C @ T _C = 100°C	Continuous Collector Current	5.0	
I _{CM}	Pulsed Collector Current ①	18	
I _{LM}	Clamped Inductive Load Current ②	18	
t _{sc}	Short Circuit Withstand Time	10	μ s
V _{GE}	Gate-to-Emitter Voltage	\pm 20	V
E _{ARV}	Reverse Voltage Avalanche Energy ③	34	mJ
P _D @ T _C = 25°C	Maximum Power Dissipation	38	W
P _D @ T _C = 100°C	Maximum Power Dissipation	15	
T _J	Operating Junction and Storage Temperature Range	-55 to + 150	°C
T _{STG}			
	Mounting torque, 6-32 or M3 screw.	10 lbf•in (1.1N•m)	

Thermal Resistance

	Parameter	Typ.	Max.	Units
R _{θJC}	Junction-to-Case	—	3.3	°C/W
R _{θCS}	Case-to-Sink, Flat, Greased Surface	0.5	—	
R _{θJA}	Junction-to-Ambient, typical socket mount	—	80	
Wt	Weight	2.0 (0.07)	—	g (oz)

IRG4BC10KPbF

Electrical Characteristics @ $T_J = 25^\circ\text{C}$ (unless otherwise specified)

	Parameter	Min.	Typ.	Max.	Units	Conditions
$V_{(BR)CES}$	Collector-to-Emitter Breakdown Voltage	600	—	—	V	$V_{GE} = 0V, I_C = 250\mu A$
$V_{(BR)ECS}$	Emitter-to-Collector Breakdown Voltage ④	18	—	—	V	$V_{GE} = 0V, I_C = 1.0A$
$\Delta V_{(BR)CES}/\Delta T_J$	Temperature Coeff. of Breakdown Voltage	—	0.58	—	V/°C	$V_{GE} = 0V, I_C = 1.0mA$
$V_{CE(ON)}$	Collector-to-Emitter Saturation Voltage	—	2.39	2.62	V	$I_C = 5.0A$ $I_C = 9.0A$ $I_C = 5.0A, T_J = 150^\circ\text{C}$ $V_{GE} = 15V$ See Fig.2, 5
		—	3.25	—		
		—	2.63	—		
$V_{GE(th)}$	Gate Threshold Voltage	3.0	—	6.5		$V_{CE} = V_{GE}, I_C = 250\mu A$
$\Delta V_{GE(th)}/\Delta T_J$	Temperature Coeff. of Threshold Voltage	—	-11	—	mV/°C	$V_{CE} = V_{GE}, I_C = 250\mu A$
g_{fe}	Forward Transconductance ⑤	1.2	1.8	—	S	$V_{CE} = 50V, I_C = 5.0A$
I_{CES}	Zero Gate Voltage Collector Current	—	—	250	μA	$V_{GE} = 0V, V_{CE} = 600V$
		—	—	2.0		$V_{GE} = 0V, V_{CE} = 10V, T_J = 25^\circ\text{C}$
		—	—	1000		$V_{GE} = 0V, V_{CE} = 600V, T_J = 150^\circ\text{C}$
I_{GES}	Gate-to-Emitter Leakage Current	—	—	± 100	nA	$V_{GE} = \pm 20V$

Switching Characteristics @ $T_J = 25^\circ\text{C}$ (unless otherwise specified)

	Parameter	Min.	Typ.	Max.	Units	Conditions
Q_g	Total Gate Charge (turn-on)	—	19	29	nC	$I_C = 5.0A$ $V_{CC} = 400V$ $V_{GE} = 15V$ See Fig.8
Q_{ge}	Gate - Emitter Charge (turn-on)	—	2.9	4.3		
Q_{gc}	Gate - Collector Charge (turn-on)	—	9.8	15		
$t_{d(on)}$	Turn-On Delay Time	—	11	—	ns	$T_J = 25^\circ\text{C}$ $I_C = 5.0A, V_{CC} = 480V$ $V_{GE} = 15V, R_G = 100\Omega$ Energy losses include "tail" See Fig. 9,10,14
t_r	Rise Time	—	24	—		
$t_{d(off)}$	Turn-Off Delay Time	—	51	77		
t_f	Fall Time	—	190	290		
E_{on}	Turn-On Switching Loss	—	0.16	—	mJ	See Fig. 9,10,14
E_{off}	Turn-Off Switching Loss	—	0.10	—		
E_{ts}	Total Switching Loss	—	0.26	0.32		
t_{sc}	Short Circuit Withstand Time	10	—	—	μs	$V_{CC} = 400V, T_J = 125^\circ\text{C}$ $V_{GE} = 15V, R_G = 100\Omega, V_{CPK} < 500V$
$t_{d(on)}$	Turn-On Delay Time	—	11	—	ns	$T_J = 150^\circ\text{C}$ $I_C = 5.0A, V_{CC} = 480V$ $V_{GE} = 15V, R_G = 100\Omega$ Energy losses include "tail" See Fig. 10,11,14
t_r	Rise Time	—	27	—		
$t_{d(off)}$	Turn-Off Delay Time	—	67	—		
t_f	Fall Time	—	350	—		
E_{ts}	Total Switching Loss	—	0.47	—	mJ	
L_E	Internal Emitter Inductance	—	7.5	—	nH	Measured 5mm from package
C_{ies}	Input Capacitance	—	220	—	pF	$V_{GE} = 0V$ $V_{CC} = 30V$ $f = 1.0MHz$ See Fig. 7
C_{oes}	Output Capacitance	—	29	—		
C_{res}	Reverse Transfer Capacitance	—	7.5	—		

Notes:

- ① Repetitive rating; $V_{GE} = 20V$, pulse width limited by max. junction temperature. (See fig. 13b)
- ② $V_{CC} = 80\%(V_{CES})$, $V_{GE} = 20V$, $L = 10\mu H$, $R_G = 100\Omega$, (See fig. 13a)
- ③ Repetitive rating; pulse width limited by maximum junction temperature.
- ④ Pulse width $\leq 80\mu s$; duty factor $\leq 0.1\%$.
- ⑤ Pulse width $5.0\mu s$, single shot.

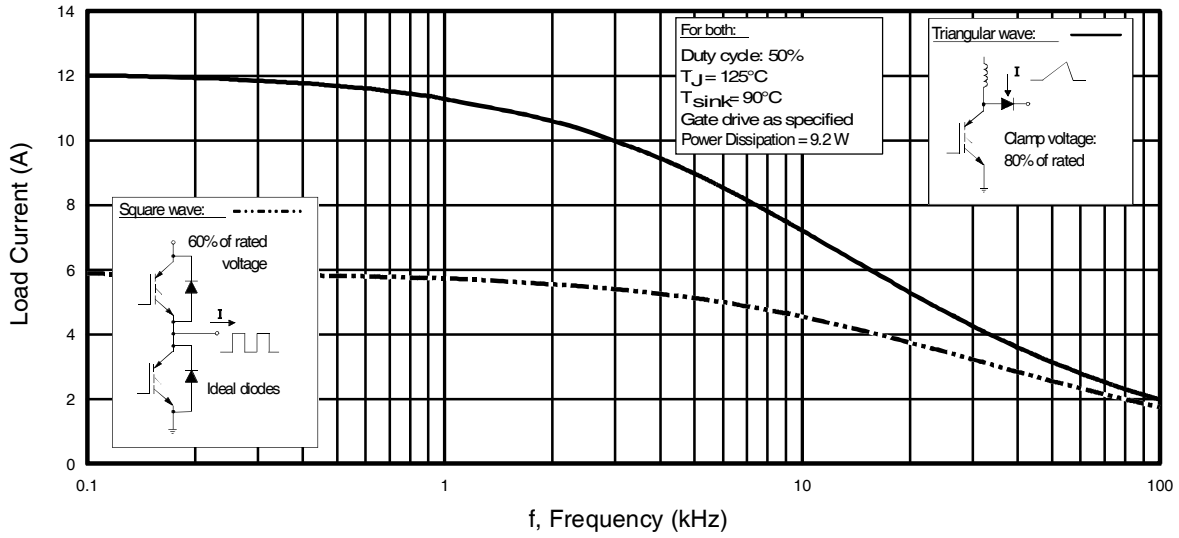

Fig. 1 - Typical Load Current vs. Frequency
 (Load Current = I_{RMS} of fundamental)

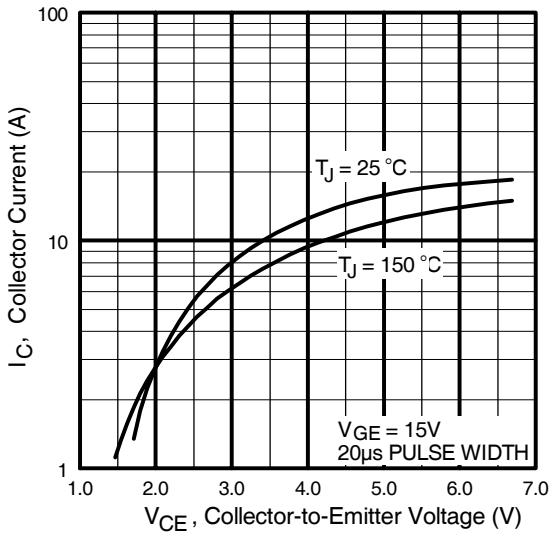

Fig. 2 - Typical Output Characteristics

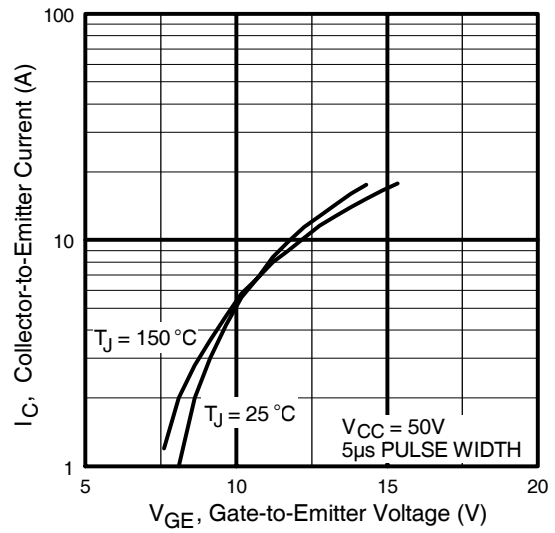

Fig. 3 - Typical Transfer Characteristics

IRG4BC10KPbF

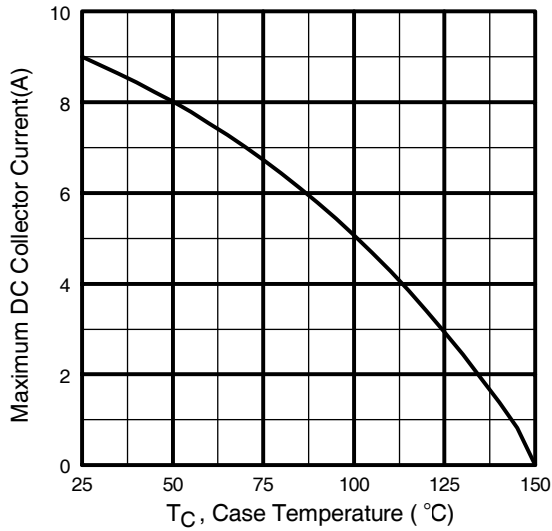

Fig. 4 - Maximum Collector Current vs. Case Temperature

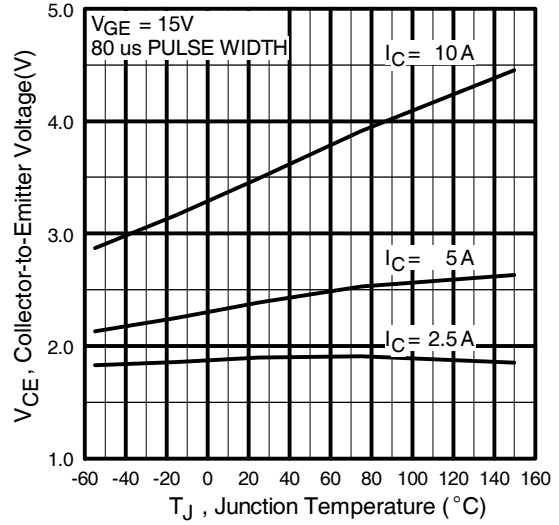

Fig. 5 - Typical Collector-to-Emitter Voltage vs. Junction Temperature

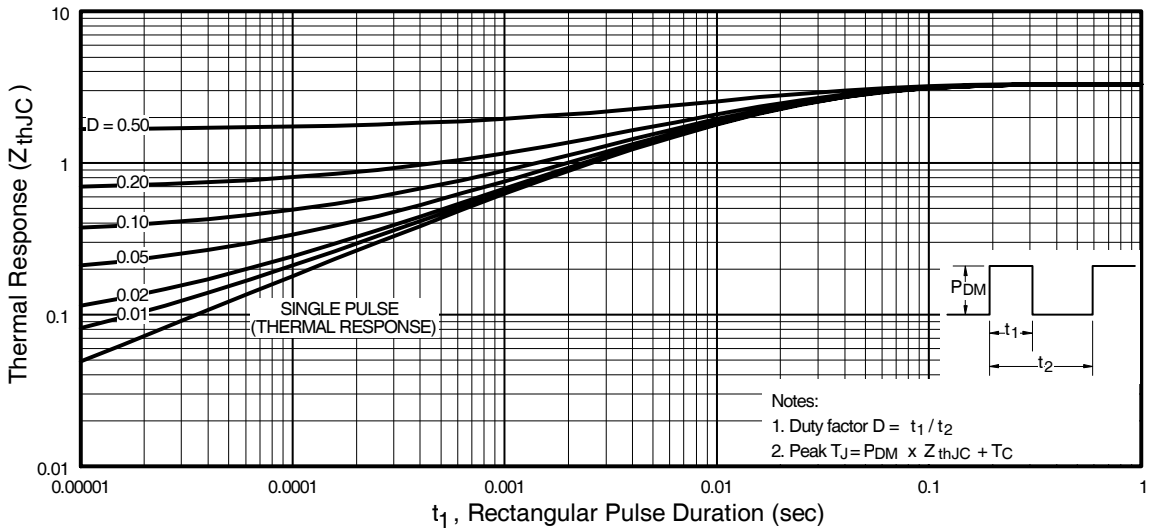

Fig. 6 - Maximum Effective Transient Thermal Impedance, Junction-to-Case

IRG4BC10KPbF

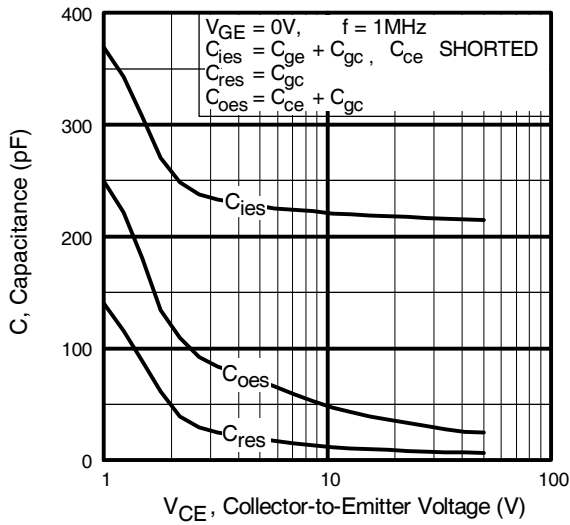

Fig. 7 - Typical Capacitance vs. Collector-to-Emitter Voltage

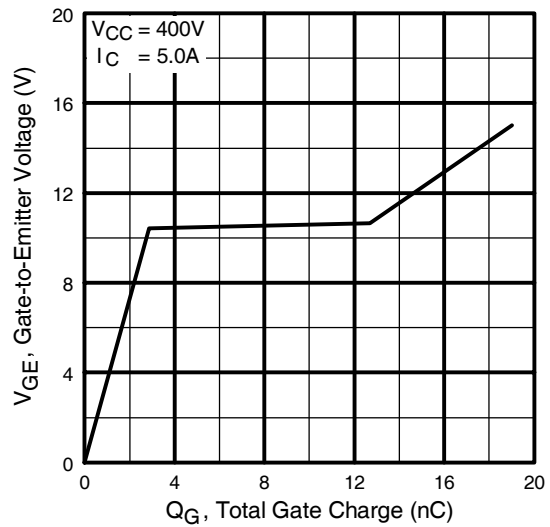

Fig. 8 - Typical Gate Charge vs. Gate-to-Emitter Voltage

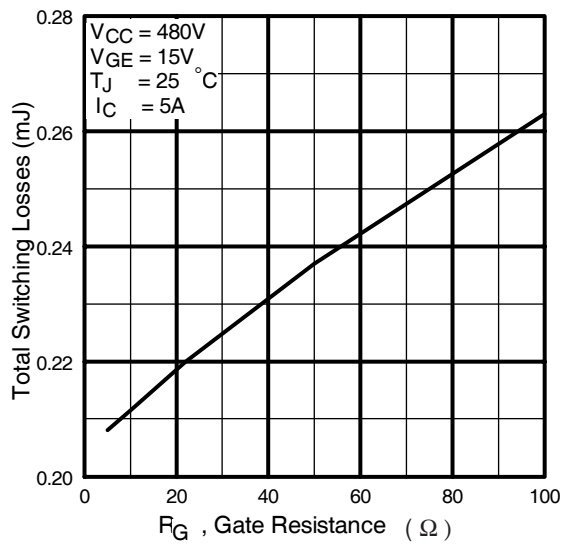

Fig. 9 - Typical Switching Losses vs. Gate Resistance

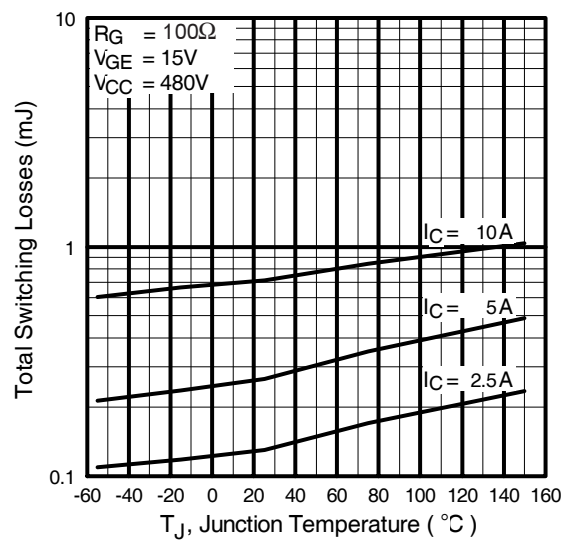

Fig. 10 - Typical Switching Losses vs. Junction Temperature

IRG4BC10KPbF

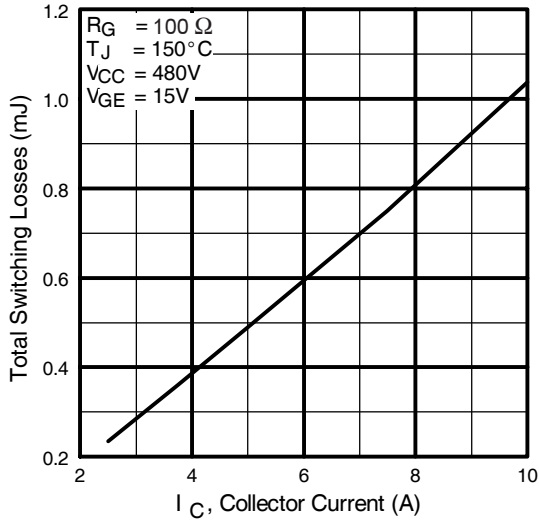

Fig. 11 - Typical Switching Losses vs. Collector Current

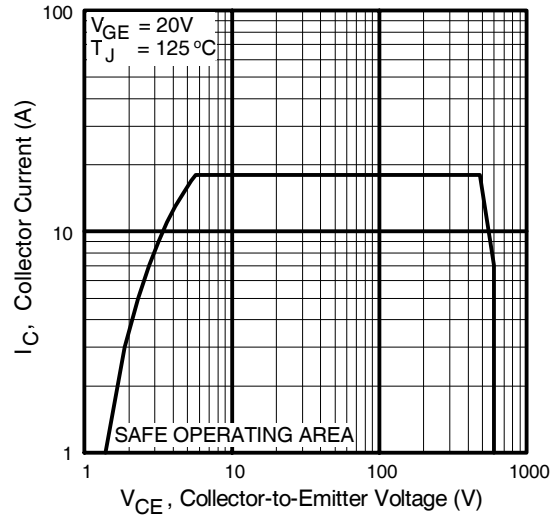

Fig. 12 - Turn-Off SOA

IRG4BC10KPbF

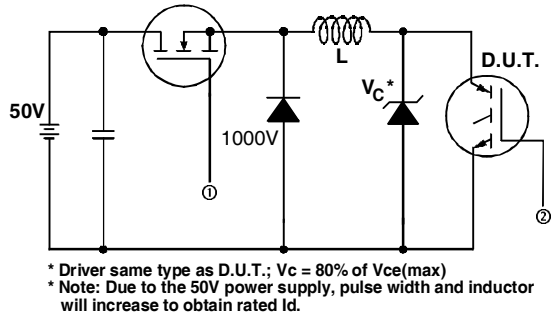

Fig. 13a - Clamped Inductive Load Test Circuit

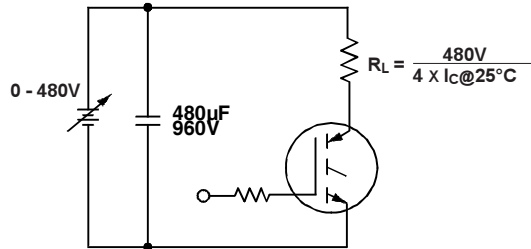

Fig. 13b - Pulsed Collector Current Test Circuit

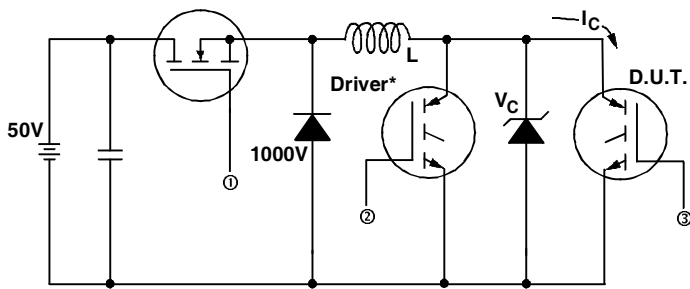

Fig. 14a - Switching Loss Test Circuit

* Driver same type as D.U.T., $V_c = 480V$

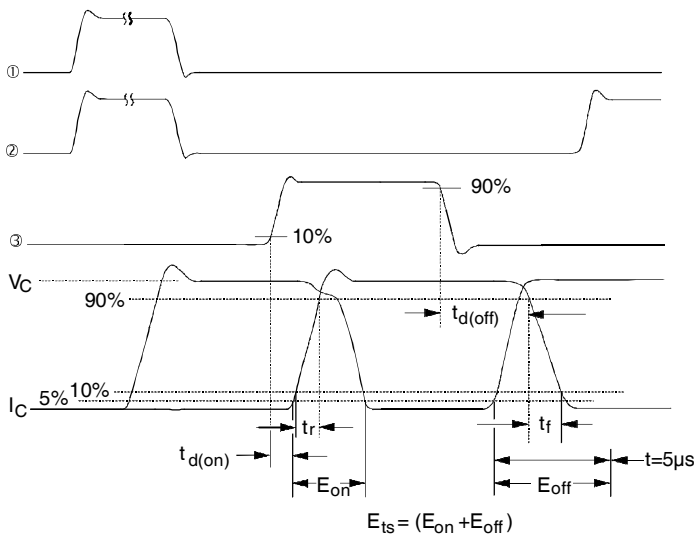

Fig. 14b - Switching Loss Waveforms

IRG4BC10KPbF



TO-220AB Package Outline

Dimensions are shown in millimeters (inches)

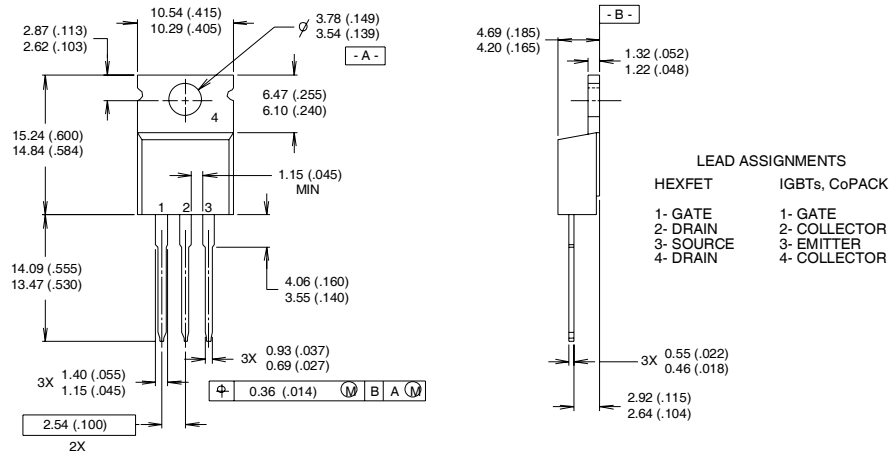

- NOTES:
- 1 DIMENSIONING & TOLERANCING PER ANSI Y14.5M, 1982.
 - 2 CONTROLLING DIMENSION : INCH
 - 3 OUTLINE CONFORMS TO JEDEC OUTLINE TO-220AB.
 - 4 HEATSINK & LEAD MEASUREMENTS DO NOT INCLUDE BURRS.

TO-220AB Part Marking Information

EXAMPLE: THIS IS AN IRF1010
 LOT CODE 1789
 ASSEMBLED ON WW 19, 1997
 IN THE ASSEMBLY LINE "C"
Note: "P" in assembly line
 position indicates "Lead-Free"

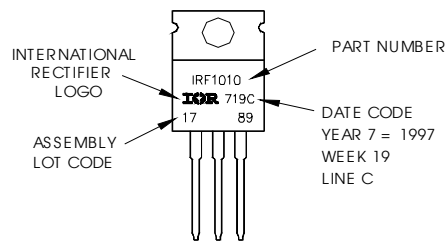

Data and specifications subject to change without notice.



IR WORLD HEADQUARTERS: 233 Kansas St., El Segundo, California 90245, USA Tel: (310) 252-7105
 TAC Fax: (310) 252-7903

Visit us at www.irf.com for sales contact information.12/03

www.irf.com

Note: For the most current drawings please refer to the IR website at:
<http://www.irf.com/package/>