

970100154

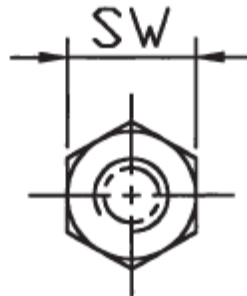
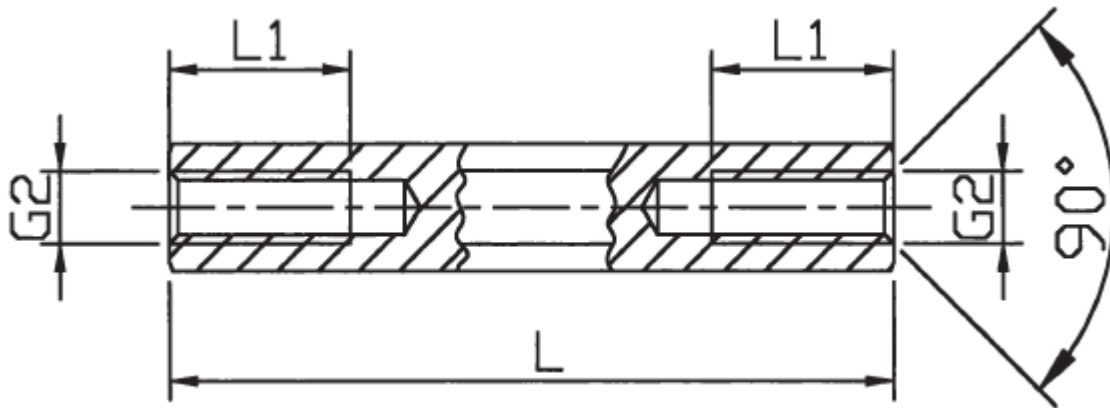

970100154

Material: CuZn39 Pb3  
Surface: nickel-plated

BRASS SPACER internal/internal

Tolerance: ± 0.1mm

SW 5	L1 = 10.0 mm			Drawn Mark Wirth 2010-12-17	Last Update Mark Wirth 2010-12-17
G1,G2 = M2.5					
L = 10.0 mm					

Würth Elektronik eiSos GmbH & Co KG  
D – 74638 Waldenburg  
Max-Eyth-Straße 1  
Tel.: 0049 7942-945-0 / Fax: 0049 7942-945-400  
www.we-online.de