

1.Outline

This product performs position detection on which the touch panel was touched by using combining NKK analog touch panel and has the function to transmit the position coordinates to hosts, such as a computer. The position coordinates of a touch panel can be transmitted as serial data by A/D conversion processing of 10 bits of decomposition ability being performed by controller chip (FT-CSU564 NKK SWITCHES CO., LTD.), and connecting with the serial port (RS-232C) of a host computer.

2.Outer Dimension

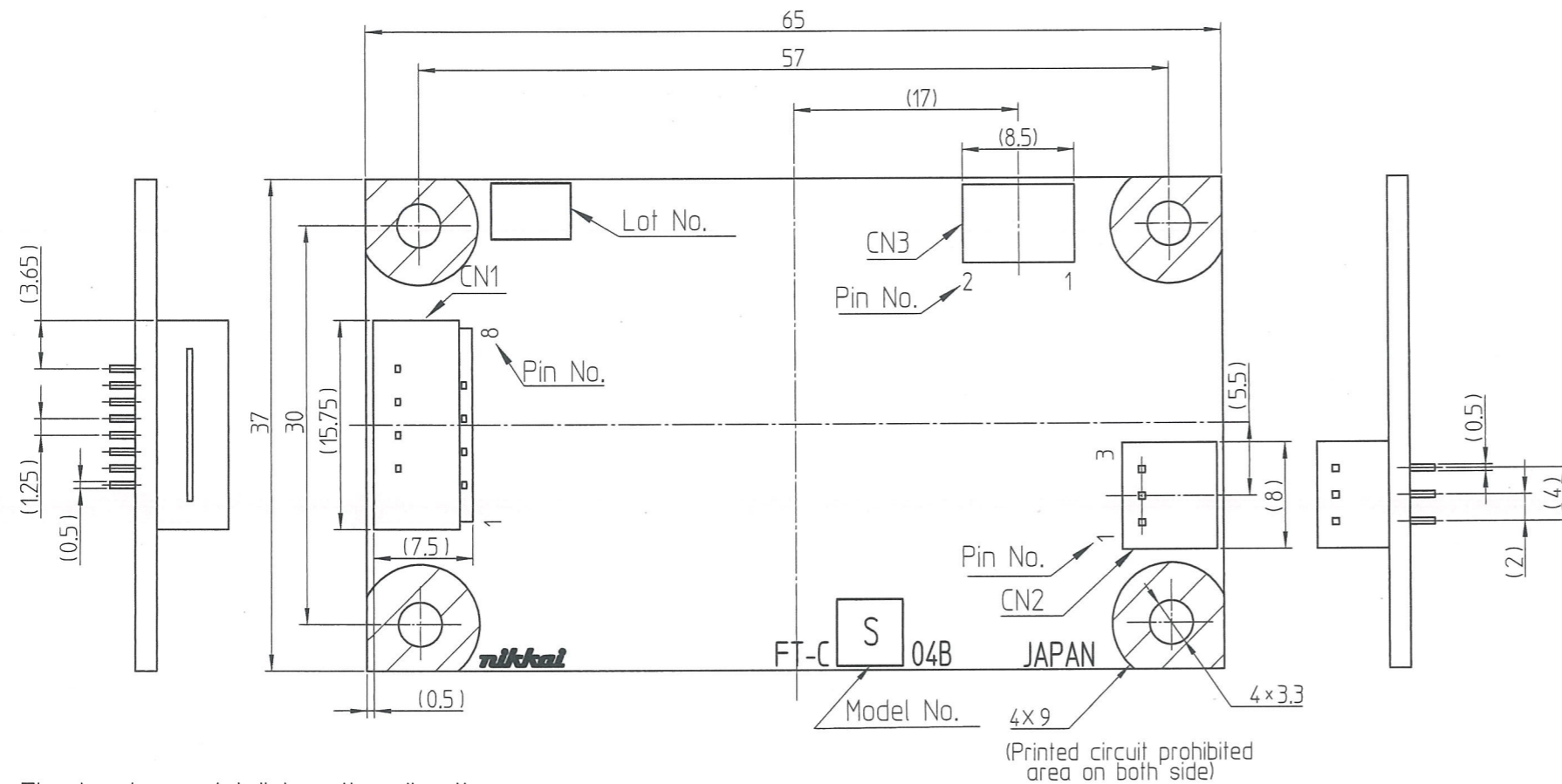

The touch panel tail insertion direction.

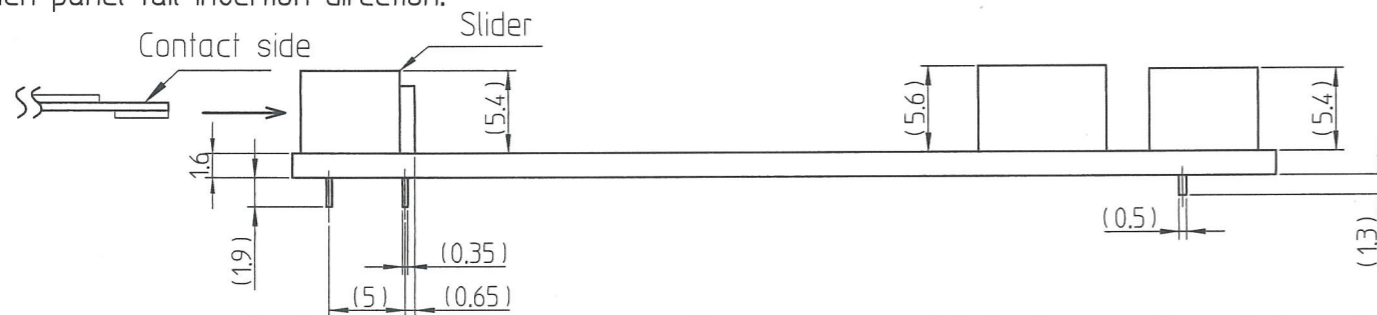

3.Connectors

Symbol	Description	Application	No.	Note
CN1	Connector	8 pins (Molex 5597-08APB7F)	1	Connect to analog touch panel.
CN2	Header connector	3 pins (HIROSE Electric DF3A-3P-2DS)	1	Connect to RS232C (Please use DF3-3S-2C (HIROSE Electric) for receptacle connector, and DF3-2428SCF (HIROSE Electric) for sockets.)
CN3	Header connector	2 pins (HIROSE Electric DF3Z-2P-2H(20))	1	Connect to power supply (Please use DF3-2S-2C (HIROSE Electric) for receptacle connector, and DF3-2428SCF (HIROSE Electric) for sockets.)

4.Block Diagram

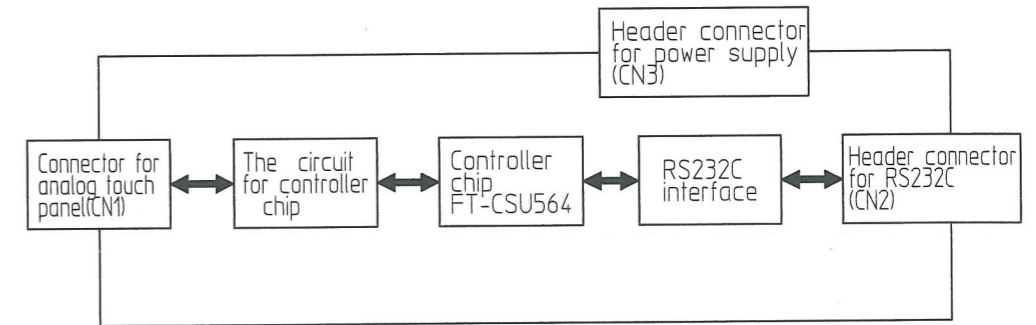

5.Basic Specification

Item	Specifications
Controller chip	FT-CSU564 (NKK)
Interface	RS232C standard
Clock frequency	6MHz
Supply voltage	5.0V
A/D converter resolution	10 bits
Consumption current	40mA Max.
Communication speed	9600 bps
Communication format	Data length : 8bit Parity : none Stop bits : 1

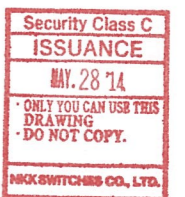

APPROVED BY:	K.SESHITA	May.27 '14	SCALE 2 : 1
CHECKED BY:	M.TAMURA	May.27 '14	DIMENSIONS IN mm
CHECKED BY:	H.KADOWAKI	May.27 '14	Unless otherwise specified tolerances
DRAWN BY:	K.MATSUSHITA	May.26 '14	Dimensions range Tolerances
MODEL No.	FT-CS04B		Up to 6 ±0.3
NKK NKK SWITCHES CO., LTD.			Over 6 up to 30 ±0.5
			Over 30 up to 50 ±0.8
			Over 50 ±1.2

6. Absolute Maximum Rating

Item	Symbol	Rated value		Unit	Conditions
		Min.	Max.		
Supply voltage	Vcc	-0.3	+5.5	[V]	
Input voltage	VTP	—	Vcc	[V]	Analog touch panel
	VRS	-15	+15	[V]	RS232C
Operating temperature	T _{OPR}	0	+70	[°C]	
Storage temperature	T _{STG}	-25	+85	[°C]	

7. Recommended Conditions

Items	Symbol	Rated value			Unit	Conditions
		Min	Typ	Max		
Power supply	Vcc	+4.75	+5	+5.25	[V]	
Operating temperature	T _{OPR}	0	—	+70	[°C]	No dew condensation.

8. Pin assignment for connectors

(1)CN1 Connector for analog touch panel(8 pins)

Pin No.	Symbol	Descriptions
1,2	Y0	For analog touch panel Y _{UP} or Y _{Lo} .
3,4	Y1	
5,6	X0	For analog touch panel X _{RI} or X _{Le} .
7,8	X1	

(2)CN2 Header connector for RS232C.(3 pins)

Controller board			Host computer Descriptions
Pin No.	Symbol	Descriptions	
1	RD	Receive data input (IN)	Send data
2	SD	Send data output (OUT)	Receive data
3	GND	GND	GND

(3)CN3 Header connector for power supply (2 pins)

Pin no.	Symbol	Descriptions
1	Vcc	Power supply
2	GND	GND

9. Function details

(1) Function explanation

Function	Contents	Explanation
Interface	Serial communication	The asynchronous serial
Sampling rate	Set to the optional value.	Calibration data mode Max130(p/s)
		Source data mode Max190(p/s)
Coordinates data format	4 bytes binary	See the "11. Format of the coordinates data"
Coordinates calculation method	Source data mode	A/D converted data is sent to the host CPU.
	Calibration data mode	Calibrated data is sent to the host CPU.
Data output mode	Point mode	It outputs the coordinates value of the first pen down only.
	Stream mode	It outputs a coordinates value continuously while the pen remains down.
Duplicate coordinate processing function	Duplicate coordinates are not sent	Compares the coordinates value transferred in the previous operation with the current coordinate data and if the coordinate values are the same, the controller does not send the current coordinate data. (Only valid in stream mode)
Time-out function	Sets the time-out time	If the required data was not received within the preset time-out time, the controller sends error code "F3h" to the host CPU.
Low power function	Stop mode	Stop mode: It stops oscillation. The way of wake up: Pen down reset, stop cancellation command
	Way of switching to each mode	The command which switches to each low power mode has the following two kinds. Direct: After receiving a command, it shifts to the low power mode immediately. Auto: After the last coordinate input, if there is no input for a preset time, the controller switches to the low power mode.
	Transition times	Transition from normal mode to low power mode: about 5μs Transition from low power mode to normal mode: clock stable time + 5μs



APPROVED BY:	K.SESHITA	May.27 '14	SCALE :	
CHECKED BY:	M.TAMURA	May.27 '14	DIMENSIONS IN mm	
CHECKED BY:	H.KADOWAKI	May.27 '14	Unless otherwise specified tolerances	
DRAWN BY:	K.MATSUSHITA	May.26 '14	Dimensions range	Tolerances
MODEL No.	FT-CS04B		Up to 6	±0.3
			Over 6 up to 30	±0.5
			Over 30 up to 50	±0.8
			Over 50	±1.2
NKK NKK SWITCHES CO., LTD.				

(1) Function explanation (Continued)

Function	Contents	Explanation
Status function	Controller setting state confirmation	It sends the setting state of the controller to the host CPU.
Interface test function	Tests the interface	It tests whether the communication between the controller and the host CPU, normally using by the optional data.
Pen up code function	1 byte	Send 1 byte pen up code when pen up.
	4 bytes	Send 4 bytes pen up code when pen up.
Lock function	Starts and clears the lock function	If a lock command is issued, after transmitting the coordinate data currently being transmitted, the controller halts transmission. The lock state is cleared by sending a lock clear command.
Reset	Software reset	Reset by the command
	Power on reset	Reset when turning on the power supply
	Watchdog reset	When the software of controller is out of controll, the reset function works automatically.
A/D converter	A/D converter resolution	10bit
Power source indicator	Power source	Blink LED on and off while the controller chip is active.

10. RS232C Specification and Commands details

(1) RS232C Specification

Item	Specifications
Communication speed	9600 bps
Communication format	Data length : 8bit Parity : none Stop bits : 1

(2) Commands

Function	Command	Command value	Number of the bytes	Description																								
Sampling rate	Setting of sampling rate	91h	3	Initial setting : 80(p/s)																								
	Sends an optional value 10 to maximum (p/s) according to the following format. bit7 bit6 bit5 bit4 bit3 bit2 bit1 Bit0 <table border="1" style="display: inline-table; vertical-align: middle;"> <tr><td>1</td><td>0</td><td>0</td><td>1</td><td>0</td><td>0</td><td>0</td><td>1</td></tr> <tr><td>0</td><td>0</td><td>0</td><td>0</td><td>z3</td><td>z2</td><td>z1</td><td>z0</td></tr> <tr><td>0</td><td>0</td><td>0</td><td>0</td><td>z7</td><td>z6</td><td>z5</td><td>z4</td></tr> </table> z0 to z7: The binary number of sampling rate (z). (z7 is the high-order bit) There is a maximum sampling rate of each mode as follows : Calibration data mode - 130 (p/s) Source data mode - 190 (p/s) Note : Be careful not to settle more than the maximum sampling rate. The coordinate data may becomes abnormal.				1	0	0	1	0	0	0	1	0	0	0	0	z3	z2	z1	z0	0	0	0	0	z7	z6	z5	z4
1	0	0	1	0	0	0	1																					
0	0	0	0	z3	z2	z1	z0																					
0	0	0	0	z7	z6	z5	z4																					
Coordinates calculation method	Source data mode	80h	1	Initial setting : Calibration data mode																								
	Calibration data mode	81h	1																									
Data output mode	Point mode	A0h	1	Initial setting : Stream mode																								
	Stream mode	A1h	1																									
Duplicate coordinate processing function	Enable	84h	1	Initial setting : Enable																								
	Disenable	85h	1																									
Time-out function	Time-out value (z)	88h	3	Initial setting : 100																								
According to the following format, it sets time-out value (z). bit7 bit6 bit5 bit4 bit3 bit2 bit1 Bit0 <table border="1" style="display: inline-table; vertical-align: middle;"> <tr><td>1</td><td>0</td><td>0</td><td>0</td><td>1</td><td>0</td><td>0</td><td>0</td></tr> <tr><td>0</td><td>0</td><td>0</td><td>0</td><td>z3</td><td>z2</td><td>z1</td><td>z0</td></tr> <tr><td>0</td><td>0</td><td>z9</td><td>z8</td><td>z7</td><td>z6</td><td>z5</td><td>z4</td></tr> </table> z0~z9: The binary number of time-out value (z). (z9 is the high-order bit) It calculates time-out time by the following formula and it sets a time-out value. Time-out time (ms)=4 × time-out value Be careful the minimum of time-out value is z ≥ 1.					1	0	0	0	1	0	0	0	0	0	0	0	z3	z2	z1	z0	0	0	z9	z8	z7	z6	z5	z4
1	0	0	0	1	0	0	0																					
0	0	0	0	z3	z2	z1	z0																					
0	0	z9	z8	z7	z6	z5	z4																					

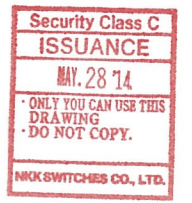

APPROVED BY:	K.SESHITA	May.27 '14	SCALE :	
CHECKED BY:	M.TAMURA	May.27 '14	DIMENSIONS IN mm	
CHECKED BY:	H.KADOWAKI	May.27 '14	Unless otherwise specified tolerances	
DRAWN BY:	K.MATSUSHITA	May.26 '14	Dimensions range	Tolerances
MODEL No.	FT-CS04B		Up to 6	±0.3
			Over 6 up to 30	±0.5
			Over 30 up to 50	±0.8
NKK NKK SWITCHES CO., LTD.			Over 50	±1.2

PRODUCT SPECIFICATION 4/6

Function	Command	Command value	Number of the bytes	Description
Calculate Calibration ratio	Calibration ratio	83h	17	According to the following format, controller calculate and sets a calibration ratio. bit7 bit6 bit5 bit4 bit3 bit2 bit1 Bit0 1 0 0 0 0 0 1 1 ← command 0 0 0 0 x3 x2 x1 x0 ← The 1st LCD reference point 0 0 x9 x8 x7 x6 x5 x4 ← x0~x9: The binary number of the horizontal axis coordinates x of the 1st reference point 0 0 0 0 y3 y2 y1 y0 ← y0~y9: The binary number of the vertical axis coordinates y of the 1st reference point (x9, y9 are the high-order bit). 0 0 y9 y8 y7 y6 y5 y4 ← The 2nd LCD reference point 0 0 0 0 X3 X2 X1 X0 ← X0~X9: The binary number of the horizontal axis coordinates X of the 2st reference point 0 0 X9 X8 X7 X6 X5 X4 ← Y0~Y9: The binary number of the vertical axis coordinates Y of the 2st reference point (x9, y9 are the high-order bit). 0 0 0 0 Y3 Y2 Y1 Y0 0 0 Y9 Y8 Y7 Y6 Y5 Y4 ← The A/D value of the 1st reference point 0 0 0 0 Ax3 Ax2 Ax1 Ax0 ← Ax0~Ax9: The binary number of the A/D value which horizontal axis coordinates x of the 1st reference point 0 0 Ax9 Ax8 Ax7 Ax6 Ax5 Ax4 ← Ay0~Ay9: The binary number of the A/D value which vertical axis coordinates y of the 1st reference point (x9, y9 are the high-order bit). 0 0 0 0 Ay3 Ay2 Ay1 Ay0 0 0 Ay9 Ay8 Ay7 Ay6 Ay5 Ay4 ← The A/D value of the 2nd reference point 0 0 0 0 AX3 AX2 AX1 AX0 ← AX0~AX9: The binary number of the A/D value which horizontal axis coordinates X of the 2nd reference point 0 0 AX9 AX8 AX7 AX6 AX5 AX4 ← AY0~AY9: The binary number of the A/D value which vertical axis coordinates Y of the 2nd reference point (x9, y9 are the high-order bit). 0 0 0 0 AY3 AY2 AY1 AY0 0 0 AY9 AY8 AY7 AY6 AY5 AY4

The absolute value of margin between the A/D value (AX,AY) of the 2nd reference point and the A/D value (Ax,Ay) of the 1st reference point are as follows.
 $|AX-Ax| > 100, |AY-Ay| > 100$
 Sent after calibration command (17 bytes) please wait more than 50 msec to send next command.

Low power function	Auto stop	B1h	2
	Direct stop	B3h	1
	Auto clear	B4h	1
	Stop clear	E2h	1

The codes and the wait time at auto mode

Codes	00h	01h	02h	03h
Wait time (second)	01	10	30	60

The way of wake up from the stop mode: Pen down, reset (only without EEPROM), stop clear command
 When canceling an auto stop mode, first send a "stop clear" command (E2h), second send an "Auto clear" command (B4h). Take an interval time (more than 50msec) between first and second commands.
 When returning from the stop mode, be sure to use stop clear command (FFh).
 (When sending a command except the stop clear command (FFh), operation doesn't guaranteed.)
 In order to change wait time at auto mode please generate reset before change wait time. There maybe wrong wait time might be set if reset is not generated.

Function	Command	Command value	Number of the bytes	Description																						
Status function	Status	C3h	2	<table border="1"> <thead> <tr> <th>Mode</th> <th>Code</th> <th>Output return value</th> </tr> </thead> <tbody> <tr> <td rowspan="2">Coordinates calculation method</td> <td>00h</td> <td>01h: Source data mode 02h: Calibration data mode</td> </tr> <tr> <td>01h</td> <td>01h: Stream mode 02h: Point mode</td> </tr> <tr> <td rowspan="2">Data output mode</td> <td>03h</td> <td>1st byte 0xh:x is the return value of lower order sampling rate value (z3~z0). 2nd byte 0xh:x is the return value of higher order sampling rate value (z7~z4).</td> </tr> <tr> <td>05h</td> <td>1st byte return value 0xh:x is the lower order time-out value (z3~z0). 2nd byte return value 0xh:x is the higher order time-out value (z9~z4).</td> </tr> <tr> <td>Duplicate coordinate processing function</td> <td>06h</td> <td>00h: Duplicate coordinate processing function disable 01h: Duplicate coordinate processing function enable</td> </tr> <tr> <td>Low power function</td> <td>07h</td> <td>00h: Direct 01h: Auto mode</td> </tr> <tr> <td>Lock function</td> <td>08h</td> <td>00h: lock condition 01h: lock clear</td> </tr> </tbody> </table>	Mode	Code	Output return value	Coordinates calculation method	00h	01h: Source data mode 02h: Calibration data mode	01h	01h: Stream mode 02h: Point mode	Data output mode	03h	1st byte 0xh:x is the return value of lower order sampling rate value (z3~z0). 2nd byte 0xh:x is the return value of higher order sampling rate value (z7~z4).	05h	1st byte return value 0xh:x is the lower order time-out value (z3~z0). 2nd byte return value 0xh:x is the higher order time-out value (z9~z4).	Duplicate coordinate processing function	06h	00h: Duplicate coordinate processing function disable 01h: Duplicate coordinate processing function enable	Low power function	07h	00h: Direct 01h: Auto mode	Lock function	08h	00h: lock condition 01h: lock clear
	Mode	Code	Output return value																							
	Coordinates calculation method	00h	01h: Source data mode 02h: Calibration data mode																							
		01h	01h: Stream mode 02h: Point mode																							
	Data output mode	03h	1st byte 0xh:x is the return value of lower order sampling rate value (z3~z0). 2nd byte 0xh:x is the return value of higher order sampling rate value (z7~z4).																							
		05h	1st byte return value 0xh:x is the lower order time-out value (z3~z0). 2nd byte return value 0xh:x is the higher order time-out value (z9~z4).																							
	Duplicate coordinate processing function	06h	00h: Duplicate coordinate processing function disable 01h: Duplicate coordinate processing function enable																							
	Low power function	07h	00h: Direct 01h: Auto mode																							
	Lock function	08h	00h: lock condition 01h: lock clear																							

Interface test function	Interface	C4h	2
A after the reception of 2 bytes data which 1 byte of interface diagnosis command (C4h) and 1 byte of optional data from the host CPU, the controller sends 1 byte of received optional data to the host CPU.			

Pen up code function	4 bytes	E3h	1	Initial setting : 1 byte
	1 byte	E4h	1	

Set the bytes of pen up code. 4 bytes or 1 byte

Lock function	Lock condition	E0h	1	Initial setting : Lock clear
	Lock clear	E1h	1	

Reset	Reset	C0h	1
	Software reset		

EEPROM reset	EEPROM Reset	C5h	1
	EEPROM reset		

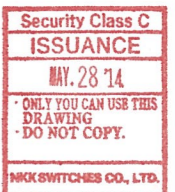

APPROVED BY:	K.SESHITA	May.27 '14	SCALE	:
CHECKED BY:	M.TAMURA	May.27 '14	DIMENSIONS in mm	
CHECKED BY:	H.KADOWAKI	May.27 '14	Unless otherwise specified tolerances	
DRAWN BY:	K.MATSUSHITA	May.26 '14	Dimensions range	Tolerances
			Up to 6	±0.3
			Over 6 up to 30	±0.5
			Over 30 up to 50	±0.8
			Over 50	±1.2

MODEL No. **FT-CS04B**
NKK NKK SWITCHES CO., LTD.

(3) Error codes

- F1 : When receiving an undefined command (the command undefined by this specification), the controller sends F1h to the host CPU.
- F2 : When receiving data which isn't defined by the command composed by plural bytes, the controller sends F2h to the host CPU.
- F3 : When the continuing data can not be received in the command after the time-out time passed, the controller sends F3h to the host CPU.
- F4 : When receiving a new command while receiving a plural composed command, the controller sends F4h to the host CPU.

Notice : Error code "F2" doesn't correspond to all plural composed commands.

11. Format of the coordinates data (4-byte)

bit	7	6	5	4	3	2	1	0	
	ph	0	0	P	X3	X2	X1	X0	1st byte
	0	0	X9	X8	X7	X6	X5	X4	2nd byte
	0	1	1	1	Y3	Y2	Y1	Y0	3rd byte
	0	0	Y9	Y8	Y7	Y6	Y5	Y4	4th byte

ph : Phase bit , always set to 1.
 P : Pen status (pen down=1, pen up=0)
 " 0 " : Always set to 0.
 X0 to X9 :The binary number of horizontal axis coordinates value (X).
 (X9 is the high-order bit)
 Y0 to Y9 :The binary number of vertical axis coordinates value (Y).
 (Y9 is the high-order bit)

According to the pen up code setting, it outputs pen up code data.

- (a)Pen up code setting:1 byte
It outputs "80h" as the pen up code data.
- (b)Pen up code setting:4 bytes
The last data would be as follows
 ph (phase bit):1
 p (pen status):0
 coordinate data (X0-X9,Y0-Y9):00h

Notice: During and after reset, the controller chip sometimes send invalid data (ex. 00h, FFh, F0h, etc.). Please ignore these data by host CPU.

12. How to set calibration ratio to controller

- (a) Set the controller to the source data mode
- (b) Display the 1st reference point P1 to the LCD.
- (c) Touch the 1st reference point P1 with the stylus.
- (d) Display the 2nd reference point P2 to the LCD.
- (e) Touch the 2nd reference point P2 with the stylus.
- (f) Host computer receive the A/D value of each 1st reference point P1 and 2nd reference point P2.
- (g) Send a calibration ratio command code (83h).
- (h) Send the LCD coordinates value of each 1st (P1) and 2nd (P2) reference point (8 bytes).
 P1→P2
- (i) Send the A/D value of each 1st (P1) and 2nd (P2) reference point (8 bytes).
 P1→P2
- (j) Switch the controller to the calibration data mode.

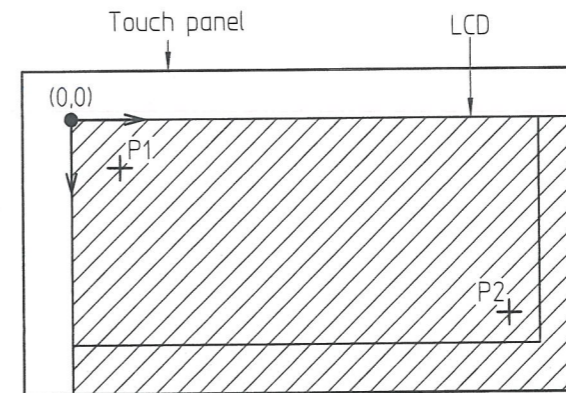
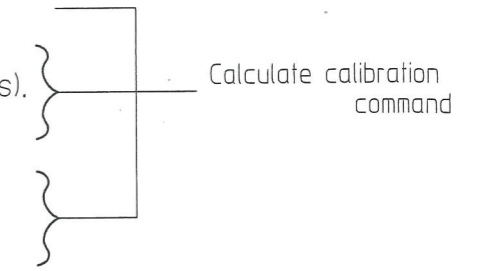

P1 : The 1st reference point as first pen down
 P2 : The 2nd reference point as 2nd pen down
 [Shaded Area] The area where data is output (The calibration data mode)

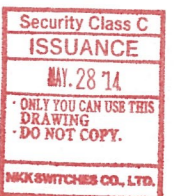

APPROVED BY:	K.SESHITA	May.27 '14	SCALE :	
CHECKED BY:	M.TAMURA	May.27 '14	Dimensions range	Unless otherwise specified tolerances
CHECKED BY:	H.KADOWAKI	May.27 '14	Up to 6	±0.3
DRAWN BY:	K.MATSUSHITA	May.26 '14	Over 6 up to 30	±0.5
			Over 30 up to 50	±0.8
			Over 50	±1.2

MODEL No. FT-CS04B
 NKK NKK SWITCHES CO., LTD.

13 NOTICE TO USE EEPROM

- (1) As EEPROM is already mounted on controller, the updated commands are stored to EEPROM and after reboot the controller will start from the updated status. In order to clear the data of EEPROM please follows the steps below.
 - (a) Send EEPROM clear command (C5h)
 - (b) Reset the controller chip
- (2) There is the limitation for number of data rewrite times to EEPROM. Please avoid to send the commands often from host CPU.

14. About the interval time

When canceling an auto stop mode or resetting controller (hardware reset, software reset, power on reset, watch dog reset), the stable time of controller must be taken. The interval time must be more than 150 (ms).

15. Notes on use

- (1) This product becomes the outside for a guarantee of operation, in use by the combination with touch panels not assembled by NKK SWITCHES CO., LTD.
- (2) On the occasion of the handling of this product, be careful enough to static electricity and take the measures against a ground of a worker and a work place.
- (3) Please switch on the power supply of this product after connection with a host and a touch panel. Moreover, please switch on the power supply of this product before host starting.
- (4) Please be sure the slider of connector CN1 is pulled out, to perform extraction and insertion of a touch-panel tail to the connector CN1. Please give the number of times of extraction and insertion of tail as 10 times or less.
- (5) Please do not perform reconstruction of this product.
- (6) This product may change the contents without a preliminary announcement for improvement.
- (7) Please do not use the commands except shown 10(2).
- (8) It cannot assume all the responsibilities to the damage that occurs by having used this product.
- (9) Please separate the tail that ties to the control board the touch panel from the noise source (inverter for the LCD drive etc.) as much as possible to avoid the malfunction by the noise.
- (10) It will assume the guaranteed term to be one year after delivery.
- (11) Even once calibration was generated, the gap may occurred between touch position and cursor position by change in ambient environment such as secular distortion, temperature change, extraction and insertion of touch panel tail to the connector, etc. In this case, calibrate again to accurate the touch and cursor position.



		APPROVED BY: K.SESHITA	May.27 '14	SCALE :	
		CHECKED BY: M.TAMURA	May.27 '14	DIMENSIONS IN mm	
		CHECKED BY: H.KADOWAKI	May.27 '14	Unless otherwise specified Tolerances	
MODEL No.	FT-CS04B		May.26 '14	Up to 6	±0.3
NKK NKK SWITCHES CO., LTD.		DRAWN BY: K.MATSUSHITA	May.26 '14	Over 6 up to 30	±0.5
				Over 30 up to 50	±0.8
				Over 50	±1.2