

Please read this notice before using the TAIYO YUDEN products.

REMINDERS

- Product information in this catalog is as of October 2017. All of the contents specified herein are subject to change without notice due to technical improvements, etc. Therefore, please check for the latest information carefully before practical application or use of our products.

Please note that TAIYO YUDEN shall not be in any way responsible for any damages and defects in products or equipment incorporating our products, which are caused under the conditions other than those specified in this catalog or individual product specification sheets.

- Please contact TAIYO YUDEN for further details of product specifications as the individual product specification sheets are available.
- Please conduct validation and verification of our products in actual condition of mounting and operating environment before using our products.
- The products listed in this catalog are intended for use in general electronic equipment (e.g., AV equipment, OA equipment, home electric appliances, office equipment, information and communication equipment including, without limitation, mobile phone, and PC) and medical equipment classified as Class I or II by IMDRF. Please be sure to contact TAIYO YUDEN for further information before using the products for any equipment which may directly cause loss of human life or bodily injury (e.g., transportation equipment including, without limitation, automotive powertrain control system, train control system, and ship control system, traffic signal equipment, disaster prevention equipment, medical equipment classified as Class III by IMDRF, highly public information network equipment including, without limitation, telephone exchange, and base station).

Please do not incorporate our products into any equipment requiring high levels of safety and/or reliability (e.g., aerospace equipment, aviation equipment*, medical equipment classified as Class IV by IMDRF, nuclear control equipment, undersea equipment, military equipment).

*Note: There is a possibility that our products can be used only for aviation equipment that does not directly affect the safe operation of aircraft (e.g., in-flight entertainment, cabin light, electric seat, cooking equipment) if such use meets requirements specified separately by TAIYO YUDEN. Please be sure to contact TAIYO YUDEN for further information before using our products for such aviation equipment.

When our products are used even for high safety and/or reliability-required devices or circuits of general electronic equipment, it is strongly recommended to perform a thorough safety evaluation prior to use of our products and to install a protection circuit as necessary.

Please note that unless you obtain prior written consent of TAIYO YUDEN, TAIYO YUDEN shall not be in any way responsible for any damages incurred by you or third parties arising from use of the products listed in this catalog for any equipment requiring inquiry to TAIYO YUDEN or prohibited for use by TAIYO YUDEN as described above.

- Information contained in this catalog is intended to convey examples of typical performances and/or applications of our products and is not intended to make any warranty with respect to the intellectual property rights or any other related rights of TAIYO YUDEN or any third parties nor grant any license under such rights.
- Please note that the scope of warranty for our products is limited to the delivered our products themselves and TAIYO YUDEN shall not be in any way responsible for any damages resulting from a fault or defect in our products. Notwithstanding the foregoing, if there is a written agreement (e.g., supply and purchase agreement, quality assurance agreement) signed by TAIYO YUDEN and your company, TAIYO YUDEN will warrant our products in accordance with such agreement.
- The contents of this catalog are applicable to our products which are purchased from our sales offices or authorized distributors (hereinafter "TAIYO YUDEN's official sales channel"). Please note that the contents of this catalog are not applicable to our products purchased from any seller other than TAIYO YUDEN's official sales channel.
- Caution for Export
Some of our products listed in this catalog may require specific procedures for export according to "U.S. Export Administration Regulations", "Foreign Exchange and Foreign Trade Control Law" of Japan, and other applicable regulations. Should you have any questions on this matter, please contact our sales staff.

MULTILAYER CERAMIC DEVICES / DIPLEXERS / 2 BRANCH COUPLER

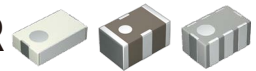

REFLOW

PARTS NUMBER

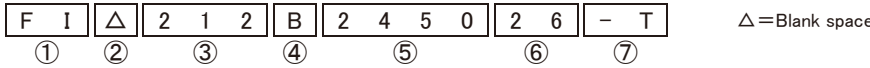

① Series name

Code	Series name
FI	High frequency devices

② Electrode code

Code	Electrode code
△	With plating

③ Dimensions

Code	Dimensions [mm]
212	2.0 × 1.25
168	1.6 × 0.8
105	1.0 × 0.5

④ Special code

Code	Special code
B	Band pass type
L	Low pass type
C	Balance type
P	Diplexer
W	2 Branch coupler
D	Dual type

⑤ Frequency

Code (example)	Frequency [MHz]
2450	2400 ~ 2500
0620	470 ~ 770

⑥ Spec code

Code	Spec code
01 ~	Individual spec

⑦ Packaging

Code	Packaging
-T	Taping

EXTERNAL DIMENSIONS / STANDARD QUANTITY

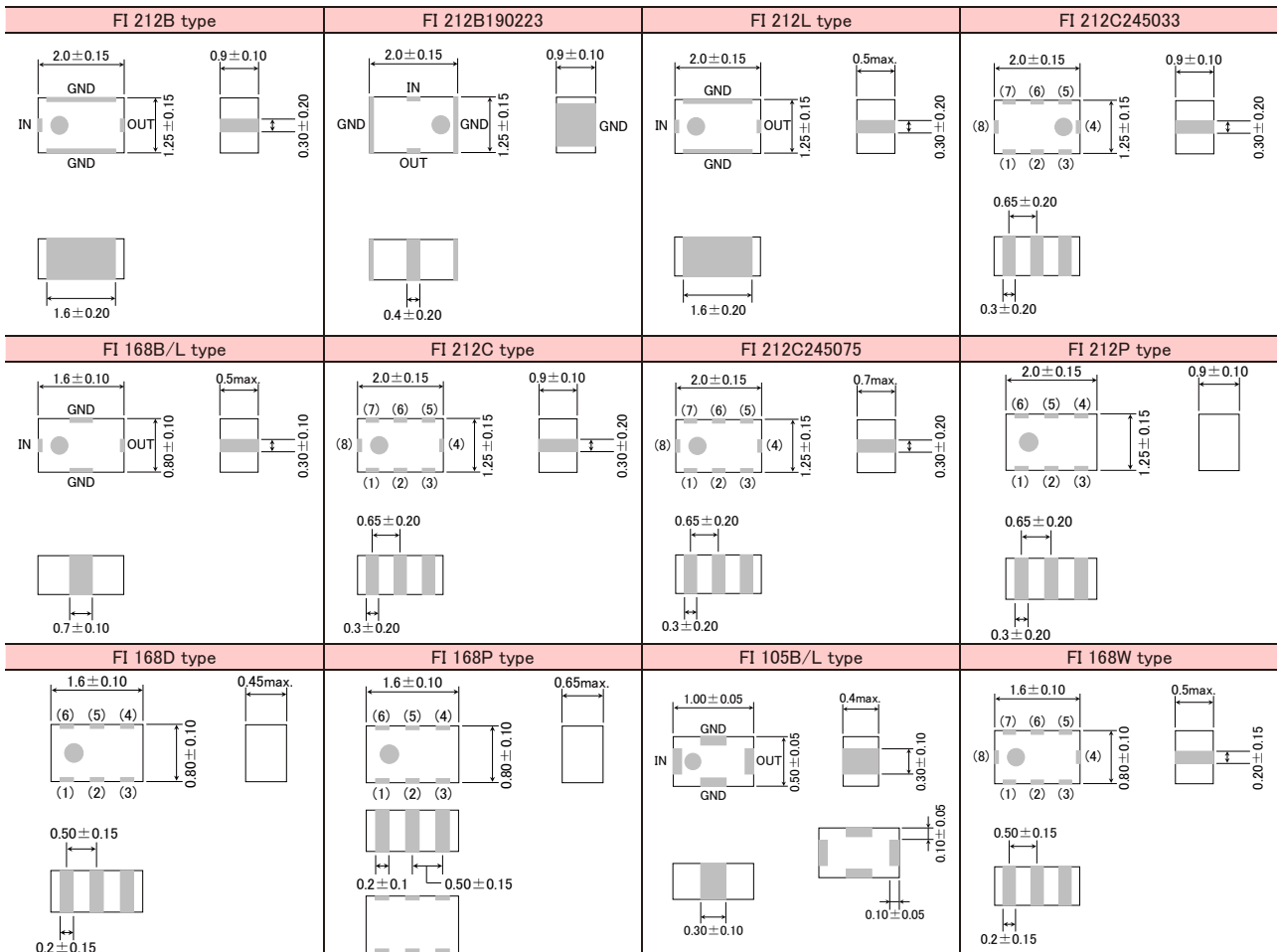

Unit : mm

▶ This catalog contains the typical specification only due to the limitation of space. When you consider the purchase of our products, please check our product specification sheets. For details of each product (characteristics graph, reliability information, precautions for use, and so on), see our website (<http://www.ty-top.com/>).

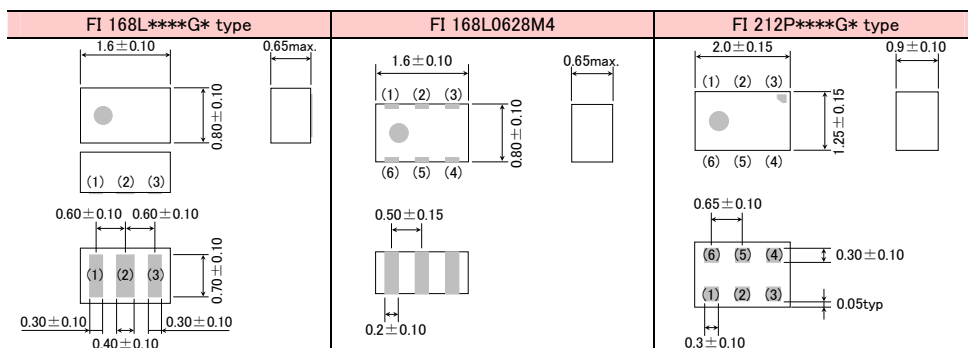

Unit:mm

	FI 212C2450**	FI 212P089208 FI 212P085912	FI 212P089213 FI 212P085909	FI 212P****G* type
(1)	Balanced	GND	GND	Low Band
(2)	GND	Common Port	Common Port	GND
(3)	Balanced	GND	GND	High Band
(4)	GND	High Band	Low Band	GND
(5)	Unbalance	GND	GND	Common
(6)	DC	Low Band	High Band	GND
(7)	NC	-	-	-
(8)	GND	-	-	-

	FI 168P245030	FI 168D087018	FI 168P157519	FI 168W type	FI 168L****G* type	FI 168L0628M4
(1)	GND	High Band IN	GND	RF1 IN/OUT	RF IN/OUT	I/O Port
(2)	Common	GND	High Band	CPL2 RF1	GND	GND
(3)	GND	Low Band IN	Common	CPL2 RF2	RF IN/OUT	I/O Port
(4)	Low Band	Low Band OUT	Low Band	GND	-	GND
(5)	GND	GND	-	RF2 OUT/IN	-	GND
(6)	High Band	High Band OUT	-	CPL1 RF2	-	GND
(7)	-	-	-	CPL1 RF1	-	-
(8)	-	-	-	GND	-	-

Type	Standard quantity[pcs]
212B	3000~6000
212L	
212C	
212P	
168B	4000~8000
168L	
168D	
168P	
168W	
105B	10000
105L	

► This catalog contains the typical specification only due to the limitation of space. When you consider the purchase of our products, please check our product specification sheets. For details of each product (characteristics graph, reliability information, precautions for use, and so on), see our website (<http://www.ty-top.com/>).

■ PARTS NUMBER

● Multilayer device band pass type

Applications	External dimensions [mm]	Part number
2.4GHz W-LAN / Bluetooth®	2.0 × 1.25 × 1.0max.	FI 212B245026
	2.0 × 1.25 × 1.0max.	FI 212B245027
	1.6 × 0.8 × 0.5max.	FI 168B245001
	1.0 × 0.5 × 0.4max.	FI 105B245024
PHS	2.0 × 1.25 × 1.0max.	FI 212B190223

● Multilayer device low pass type

Applications	External dimensions [mm]	Part number
Digital TV	1.6 × 0.8 × 0.45max.	FI 168L062005
2.4GHz W-LAN / Bluetooth®	1.0 × 0.5 × 0.4max.	FI 105L250014
	1.0 × 0.5 × 0.4max.	FI 105L087038
Cellular	1.6 × 0.8 × 0.65max.	FI 168L0628M4
	1.6 × 0.8 × 0.65max.	FI 168L2200G9

Applications	External dimensions [mm]	Part number	Notes
Other	1.6 × 0.8 × 0.45max.	FI 168D087018	Dual band LPF

● Multilayer device balance type

Applications	External dimensions [mm]	Part number	Notes
Bluetooth®	2.0 × 1.25 × 1.0max.	FI 212C245033	Conjugated match to CSR BC3
	2.0 × 1.25 × 1.0max.	FI 212C245036	Conjugated match to CSR BC5
	2.0 × 1.25 × 0.7max.	FI 212C245075	Conjugated match to CSR BC5FM, BC6ROM

● Multilayer diplexer

Applications	External dimensions [mm]	Part number
W-LAN	1.6 × 0.8 × 0.65max.	FI 168P245030
	2.0 × 1.25 × 1.0max.	FI 212P082931
Cellular	2.0 × 1.25 × 1.0max.	FI 212P0829G2
	2.0 × 1.25 × 1.0max.	FI 212P082934
	2.0 × 1.25 × 1.0max.	FI 212P082935
	2.0 × 1.25 × 1.0max.	FI 212P089208
	2.0 × 1.25 × 1.0max.	FI 212P089213
	2.0 × 1.25 × 1.0max.	FI 212P085909
	2.0 × 1.25 × 1.0max.	FI 212P085912
	GPS / 2.4GHz W-LAN	1.6 × 0.8 × 0.65max.
1.6 × 0.8 × 0.65max.		FI 168P157525

● Multilayer coupler

Applications	External dimensions [mm]	Part number
Cellular	1.6 × 0.8 × 0.5max.	FI 168W1697B1

▶ This catalog contains the typical specification only due to the limitation of space. When you consider the purchase of our products, please check our product specification sheets. For details of each product (characteristics graph, reliability information, precautions for use, and so on), see our website (<http://www.ty-top.com/>).

FI 212B245026

Pass band frequency	2400 ~ 2500 MHz
Insertion loss at pass band	2.6 dB max. (+25°C) 2.9 dB max. (-40~+85°C)
Ripple at pass band	1.0 dB max.
V.S.W.R. at pass band	2.0 max.
Attenuation	40 dB min. (800 ~ 960 MHz) 30 dB min. (1710 ~ 1990 MHz) 25 dB min. (2110 ~ 2170 MHz) 30 dB min. (4800 ~ 5000 MHz) 30 dB min. (7200 ~ 7500 MHz)
Impedance	50 Ω

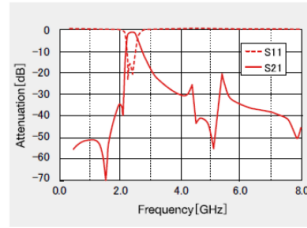

FI 212B245027

Pass band frequency	2400 ~ 2500 MHz
Insertion loss at pass band	1.4 dB max. (+25°C) 1.7 dB max. (-40~+85°C)
Ripple at pass band	1.0 dB max.
V.S.W.R. at pass band	2.0 max.
Attenuation	30 dB min. (800 ~ 915 MHz) 30 dB min. (1710 ~ 1910 MHz) 6 dB min. (2110 ~ 2170 MHz) 20 dB min. (4800 ~ 5000 MHz)

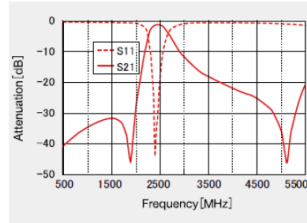

FI 168B245001

Pass band frequency	2400 ~ 2500 MHz
Insertion loss at pass band	2.2 dB max. (+25°C) 2.5 dB max. (-30~+85°C)
Ripple at pass band	1.0 dB max.
V.S.W.R. at pass band	2.1 max.
Attenuation	25 dB min. (800 ~ 960 MHz) 25 dB min. (1710 ~ 1910 MHz) 20 dB min. (4800 ~ 5000 MHz) 20 dB min. (7200 ~ 7500 MHz)
Impedance	50 Ω

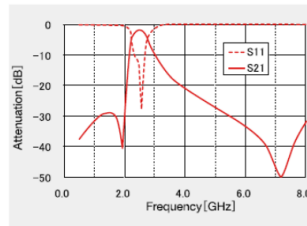

FI 105B245024

Pass band frequency	2400 ~ 2500 MHz
Insertion loss at pass band	3.0 dB max. (+25°C) 3.3 dB max. (-40~+85°C)
Ripple at pass band	1.0 dB max.
V.S.W.R. at pass band	2.2 max.
Attenuation	25 dB min. (800 ~ 960 MHz) 22 dB min. (1710 ~ 1910 MHz) 20 dB min. (4800 ~ 5000 MHz) 20 dB min. (7200 ~ 7500 MHz)

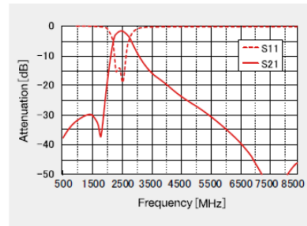

FI 212B190223

Pass band frequency	1884 ~ 1930 MHz
Insertion loss at 1884 ~ 1920 MHz	1.7 dB max. (+25°C) 2.0 dB max. (-30~+85°C)
Insertion loss at 1920 ~ 1930 MHz	1.7 dB max. (+25°C) 2.0 dB max. (-30~+85°C)
Ripple at pass band	1.0 dB max.
V.S.W.R. at pass band	2.0 max.
Attenuation	30 dB min. (1420 MHz) 18 dB min. (3768 ~ 3860 MHz)
Impedance	50 Ω

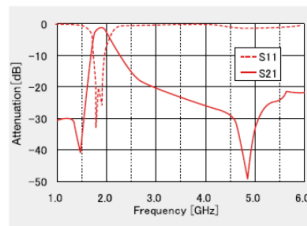

FI 168L062005

Pass band frequency	470 ~ 770 MHz
Insertion loss at 470 ~ 600 MHz	1.2 dB max. (+25°C) 1.3 dB max. (-30~+85°C)
Insertion loss at 600 ~ 710 MHz	2.2 dB max. (+25°C) 2.4 dB max. (-30~+85°C)
Insertion loss at 710 ~ 770 MHz	4.0 dB max. (+25°C) 4.4 dB max. (-30~+85°C)
Ripple at 470 ~ 710 MHz	1.4 dB max.
V.S.W.R.	2.0 max. (470 ~ 710 MHz) 2.5 max. (710 ~ 770 MHz)
Attenuation	25 dB min. (888 ~ 925 MHz) (+25°C) 21 dB min. (888 ~ 925 MHz) (-30~+85°C) 25 dB min. (940 ~ 960 MHz) 27 dB min. (1429 ~ 1453 MHz) 26 dB min. (1920 ~ 1980 MHz) 26 dB min. (2400 ~ 2500 MHz)
Impedance	50 Ω

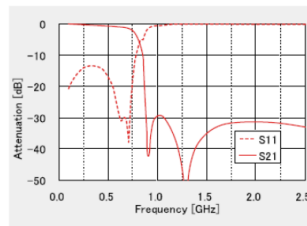

► This catalog contains the typical specification only due to the limitation of space. When you consider the purchase of our products, please check our product specification sheets. For details of each product (characteristics graph, reliability information, precautions for use, and so on), see our website (<http://www.ty-top.com/>).

FI 105L250014

Pass band frequency	2400 - 2500 MHz
Insertion loss at 2400 - 2500 MHz	0.45 dB max. (+25°C) 0.55 dB max. (-40~+85°C)
V.S.W.R. at 2400 - 2500 MHz	1.7 max.
Attenuation	21 dB min. (4800 - 5000 MHz) 21 dB min. (7200 - 7500 MHz)
Impedance	50 Ω

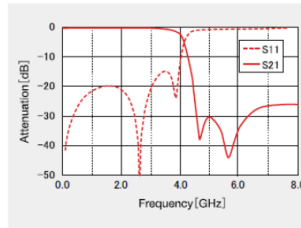

FI 105L087038

Pass band frequency	824 - 915 MHz
Insertion loss at 824 - 915 MHz	0.75 dB max. (-30~+85°C)
V.S.W.R. at 2400 - 2500 MHz	1.5 max.
Attenuation	23 dB min. (1648 - 1830 MHz) 23 dB min. (2472 - 2745 MHz)
Impedance	50 Ω

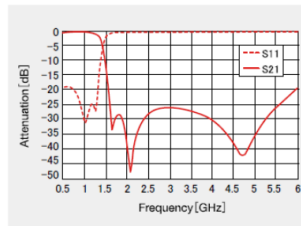

FI 168L0628M4

Pass band frequency	470 - 787 MHz
Insertion loss at pass band	0.5 dB max. (+25°C) 0.6 dB max. (-40~+90°C)
Ripple at pass band	-
V.S.W.R. at pass band	2.0 max.
Attenuation	26 dB min. (1429 - 1501 MHz) 30 dB min. (1565 - 1607 MHz) 35 dB min. (1570 - 1580 MHz) 18 dB min. (1920 - 1980 MHz)
Impedance	50 Ω

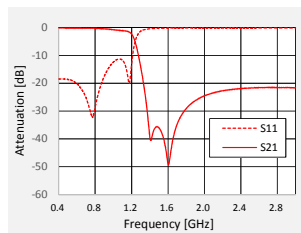

FI 168L2200G9

Pass band frequency	1700 - 2170 MHz 2170 - 2500 MHz 2500 - 2700 MHz
Insertion loss at 1700 - 2170 MHz	0.5 dB max. (+25°C) 0.55 dB max. (-30~+85°C)
Insertion loss at 2170 - 2500 MHz	0.65 dB max. (+25°C) 0.75 dB max. (-30~+85°C)
Insertion loss at 2500 - 2700 MHz	0.9 dB max. (+25°C) 1.0 dB max. (-30~+85°C)
Return loss. at 1700 - 2700 MHz	10 dB min.
Attenuation	25 dB min. (3400 MHz) 22 dB min. (3400 - 5400 MHz) 20 dB min. (5400 - 8100 MHz)
Impedance	50 Ω

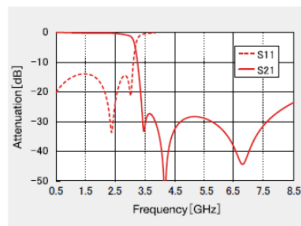

FI 168D087018

Low band	
Pass band frequency	824 - 915 MHz
Insertion loss at 824 - 915 MHz	0.6 dB max. (-30~+85°C)
V.S.W.R. at 824 - 915 MHz	1.5 max.
Attenuation	25 dB min. (1648 - 1830 MHz) 25 dB min. (2472 - 2745 MHz)
Impedance	50 Ω

High band	
Pass band frequency	1710 - 1910 MHz
Insertion loss at 1710 - 1910 MHz	0.6 dB max. (-30~+85°C)
V.S.W.R. at 824 - 915 MHz	1.5 max.
Attenuation	25 dB min. (3420 - 3820 MHz) 25 dB min. (5130 - 5730 MHz)
Impedance	50 Ω
Isolation	
In to In/Out to Out	27 dB min. (824 - 915 MHz) 30 dB min. (1710 - 1910 MHz)
In to Out	30 dB min. (824 - 915 MHz) 30 dB min. (1710 - 1910 MHz)

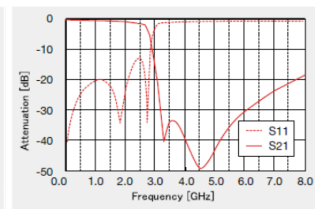
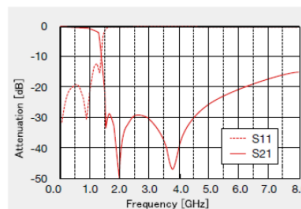

▶ This catalog contains the typical specification only due to the limitation of space. When you consider the purchase of our products, please check our product specification sheets. For details of each product (characteristics graph, reliability information, precautions for use, and so on), see our website (<http://www.ty-top.com/>).

FI 212C245033

Pass band frequency	2400 – 2500 MHz
Insertion loss at pass band	2.7 dB (+25°C) 3.0 dB (-30~+85°C)
Ripple at pass band	1.0 dB max.
Unbalanced port V.S.W.R. at pass band	2.0 max.
Balanced port V.S.W.R. at pass band	2.0 max.
Amplitude Imbalance at pass band	2.0 dB max.
Phase Imbalance at pass band	180 ± 10°C
Attenuation	25 dB min. (880 – 960 MHz) 15 dB min. (1710 – 1990 MHz) 15 dB min. (1990 – 2170 MHz) 15 dB min. (4800 – 5000 MHz)
Unbalanced port Impedance	50 Ω
Balanced port Impedance	Conjugated match to CSR BC3

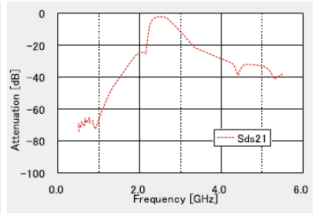
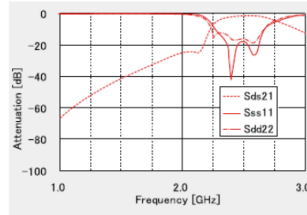

FI 212C245036

Pass band frequency	2400 – 2500 MHz
Insertion loss at pass band	3.7 dB (+25°C) 4.0 dB (-30~+85°C)
Ripple at pass band	1.0 dB max.
Unbalanced port V.S.W.R. at pass band	2.0 max.
Balanced port V.S.W.R. at pass band	2.0 max.
Amplitude Imbalance at pass band	2.0 dB max.
Phase Imbalance at pass band	180 ± 10°C
Attenuation	35 dB min. (880 – 960 MHz) 20 dB min. (1710 – 1990 MHz) 15 dB min. (1990 – 2170 MHz) 20 dB min. (4800 – 5000 MHz)
Unbalanced port Impedance	50 Ω
Balanced port Impedance	Conjugated match to CSR BC5

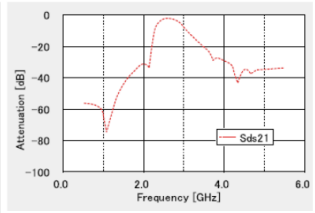
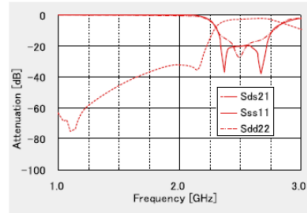

FI 212C245075

Pass band frequency	2400 – 2500 MHz
Insertion loss at pass band	3.7 dB (+25°C) 4.0 dB (-30~+85°C)
Ripple at pass band	1.0 dB max.
Unbalanced port V.S.W.R. at pass band	2.2 max.
Balanced port V.S.W.R. at pass band	2.2 max.
Amplitude Imbalance at pass band	2.0 dB max.
Phase Imbalance at pass band	180 ± 10°C
Attenuation	40 dB min. (880 – 960 MHz) 18 dB min. (1710 – 1990 MHz) 12 dB min. (1990 – 2170 MHz) 30 dB min. (4800 – 5000 MHz)
Unbalanced port Impedance	50 Ω
Balanced port Impedance	Conjugated match to CSR BC5FM, BC6ROM

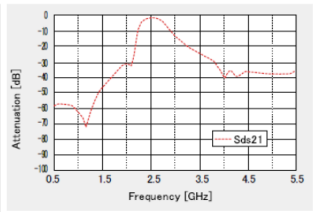
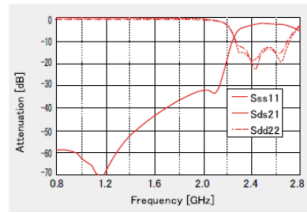

FI 168P245030

Low band	
Pass band frequency 1	1558 – 1610 MHz
Pass band frequency 2	2400 – 2500 MHz
Insertion loss at Pass band 1	0.50 dB max.
Insertion loss at Pass band 2	0.60 dB max.
V.S.W.R. at Pass band	2.0 dB max.
Attenuation	24 dB min. (4800 – 4900 MHz) 26 dB min. (4900 – 6000 MHz)
Impedance	50 Ω
High band	
Pass band frequency	4900 – 5950 MHz
Insertion loss at Pass band	0.80 dB max.
V.S.W.R. at Pass band	2.0 dB max.
Attenuation	32 dB min. (30 – 2700 MHz)
Impedance	50 Ω

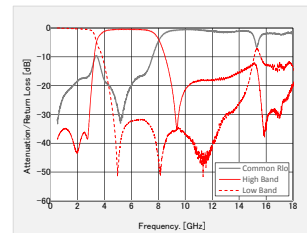

► This catalog contains the typical specification only due to the limitation of space. When you consider the purchase of our products, please check our product specification sheets. For details of each product (characteristics graph, reliability information, precautions for use, and so on), see our website (<http://www.ty-top.com/>).

FI 212P082931

Low band	
Pass band frequency 1	698 – 894 MHz
Pass band frequency 2	880 – 960 MHz
Insertion loss at 698 – 894 MHz	0.50 dB max. (+25°C) 0.60 dB max. (-40~+85°C)
Insertion loss at 880 – 960 MHz	0.70 dB max. (+25°C) 0.80 dB max. (-40~+85°C)
V.S.W.R. at 698 – 894 MHz	2.0 max.
V.S.W.R. at 880 – 960 MHz	2.0 max.
Attenuation	13 dB min. (1420 – 2690 MHz)
Impedance	50 Ω

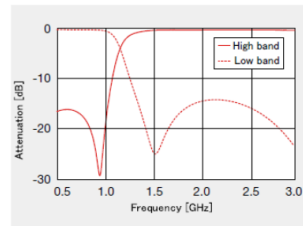

High band	
Pass band frequency 1	1420 – 1520 MHz
Pass band frequency 2	1560 – 1610 MHz
Pass band frequency 3	1710 – 2170 MHz
Pass band frequency 4	2300 – 2690 MHz
Insertion loss at 1420 – 1520 MHz	0.70 dB max. (+25°C) 0.80 dB max. (-40~+85°C)
Insertion loss at 1560 – 1610 MHz	0.50 dB max. (+25°C) 0.60 dB max. (-40~+85°C)
Insertion loss at 1710 – 2170 MHz	0.50 dB max. (+25°C) 0.60 dB max. (-40~+85°C)
Insertion loss at 2300 – 2690 MHz	0.50 dB max. (+25°C) 0.60 dB max. (-40~+85°C)
V.S.W.R. at 1420 – 2690 MHz	2.0 max.
Attenuation	13 dB min. (698 – 960 MHz)
Impedance	50 Ω

FI 212P0829G2

Low band	
Pass band frequency	698 – 960 MHz
Insertion loss at 698 – 960 MHz	0.27 dB max. (+25°C) 0.32 dB max. (-40~+85°C)
V.S.W.R. at 698 – 960 MHz	2.0 max.
Attenuation	13 dB min. (1710 – 2690 MHz)
Impedance	50 Ω

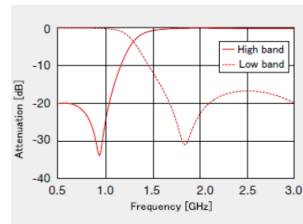

High band	
Pass band frequency	1710 – 2690 MHz
Insertion loss at 1710 – 2690 MHz	0.45 dB max. (+25°C) 0.55 dB max. (-40~+85°C)
V.S.W.R. at 698 – 960 MHz	2.0 max.
Attenuation	19 dB min. (698 – 960 MHz)
Impedance	50 Ω

FI 212P082934

Low band	
Pass band frequency	698 – 960 MHz
Insertion loss at 698 – 960 MHz	0.50 dB max. (-40~+85°C)
V.S.W.R. at 698 – 960 MHz	1.4 max.
Attenuation	15 dB min. (1554 – 1580 MHz) 25 dB min. (1710 – 2110 MHz) 25 dB min. (2110 – 2155 MHz) 25 dB min. (2155 – 2690 MHz) 12 dB min. (2155 – 7830 MHz)
Impedance	50 Ω

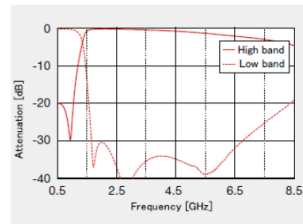

High band	
Pass band frequency 1	1710 – 2170 MHz
Pass band frequency 2	2500 – 2690 MHz
Insertion loss at 1710 – 2170 MHz	0.50 dB max. (-40~+85°C)
Insertion loss at 2500 – 2690 MHz	0.55 dB max. (-40~+85°C)
V.S.W.R. at 1710 – 2170 MHz	1.4 max.
V.S.W.R. at 2500 – 2690 MHz	1.8 max.
Attenuation	17 dB min. (0.3 – 960 MHz)
Impedance	50 Ω

▶ This catalog contains the typical specification only due to the limitation of space. When you consider the purchase of our products, please check our product specification sheets. For details of each product (characteristics graph, reliability information, precautions for use, and so on), see our website (<http://www.ty-top.com/>).

FI 212P082935

Low band	
Pass band frequency	698 - 960 MHz
Insertion loss at 698 - 960 MHz	0.50 dB max. (-40~+85°C)
V.S.W.R. at 698 - 960 MHz	1.4 max.
Attenuation	15 dB min. (1554 - 1580 MHz) 25 dB min. (1710 - 2110 MHz) 25 dB min. (2110 - 2155 MHz) 25 dB min. (2155 - 2690 MHz) 12 dB min. (2155 - 7830 MHz)
Impedance	50 Ω
High band	
Pass band frequency 1	1710 - 2170 MHz
Pass band frequency 2	2500 - 2690 MHz
Insertion loss at 1710 - 2170 MHz	0.50 dB max. (-40~+85°C)
Insertion loss at 2500 - 2690 MHz	0.55 dB max. (-40~+85°C)
V.S.W.R. at 1710 - 2170 MHz	1.4 max.
V.S.W.R. at 2500 - 2690 MHz	1.8 max.
Attenuation	17 dB min. (0.3 - 960 MHz)
Impedance	50 Ω

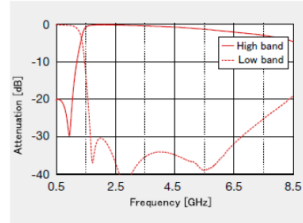

FI 212P089208

Low band	
Pass band frequency	698 - 960 MHz
Insertion loss at 698 - 960 MHz	0.27 dB max. (+25°C) 0.32 dB max. (-40~+85°C)
V.S.W.R. at 698 - 960 MHz	2.0 max.
Attenuation	13 dB min. (1710 - 2170 MHz)
Impedance	50 Ω
High band	
Pass band frequency	1710 - 2170 MHz
Insertion loss at 1710 - 2170 MHz	0.45 dB max. (+25°C) 0.55 dB max. (-40~+85°C)
V.S.W.R. at 698 - 960 MHz	2.0 max.
Attenuation	19 dB min. (698 - 960 MHz)
Impedance	50 Ω

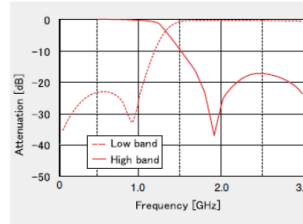

FI 212P089213

Low band	
Pass band frequency	698 - 960 MHz
Insertion loss at 698 - 960 MHz	0.27 dB max. (+25°C) 0.32 dB max. (-40~+85°C)
V.S.W.R. at 698 - 960 MHz	2.0 max.
Attenuation	13 dB min. (1710 - 2170 MHz)
Impedance	50 Ω
High band	
Pass band frequency	1710 - 2170 MHz
Insertion loss at 1710 - 2170 MHz	0.45 dB max. (+25°C) 0.55 dB max. (-40~+85°C)
V.S.W.R. at 698 - 960 MHz	2.0 max.
Attenuation	19 dB min. (698 - 960 MHz)
Impedance	50 Ω

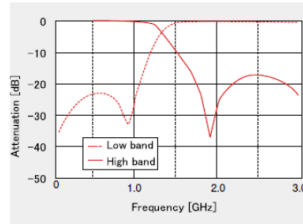

FI 212P085909

Low band	
Pass band frequency	698 - 960 MHz
Insertion loss at 698 - 960 MHz	0.70 dB max. (+25°C) 0.75 dB max. (-30~+85°C)
V.S.W.R. at 698 - 960 MHz	1.6 max.
Attenuation	19 dB min. (1558 - 1570 MHz) 20 dB min. (1570 - 1580 MHz) 19 dB min. (1580 - 1610 MHz)
Impedance	50 Ω
High band	
Pass band frequency 1	1558 - 1570 MHz
Pass band frequency 2	1570 - 1580 MHz
Pass band frequency 3	1580 - 1610 MHz
Insertion loss at 1558 - 1570 MHz	0.75 dB max. (+25°C) 0.85 dB max. (-30~+85°C)
Insertion loss at 1570 - 1580 MHz	0.70 dB max. (+25°C) 0.80 dB max. (-30~+85°C)
Insertion loss at 1580 - 1610 MHz	0.70 dB max. (+25°C) 0.80 dB max. (-30~+85°C)
V.S.W.R. at 1558 - 1570 MHz	1.6 max.
V.S.W.R. at 1570 - 1580 MHz	1.6 max.
V.S.W.R. at 1580 - 1610 MHz	1.6 max.
Attenuation	35 dB min. (698 - 824 MHz) 42 dB min. (824 - 894 MHz) 25 dB min. (894 - 960 MHz)
Impedance	50 Ω

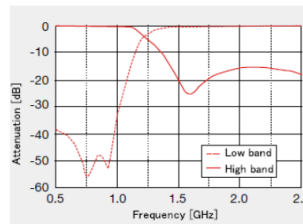

▶ This catalog contains the typical specification only due to the limitation of space. When you consider the purchase of our products, please check our product specification sheets. For details of each product (characteristics graph, reliability information, precautions for use, and so on), see our website (<http://www.ty-top.com/>).

FI 212P085912

Low band	
Pass band frequency	698 - 960 MHz
Insertion loss at 698 - 960 MHz	0.70 dB max. (+25°C)
	0.75 dB max. (-30~+85°C)
V.S.W.R. at 698 - 960 MHz	1.6 max.
Attenuation	19 dB min. (1558 - 1570 MHz)
	20 dB min. (1570 - 1580 MHz)
	19 dB min. (1580 - 1610 MHz)
Impedance	50 Ω

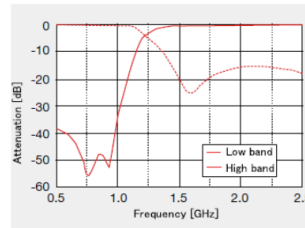

High band	
Pass band frequency 1	1558 - 1570 MHz
Pass band frequency 2	1570 - 1580 MHz
Pass band frequency 3	1580 - 1610 MHz
Insertion loss at 1558 - 1570 MHz	0.75 dB max. (+25°C)
	0.85 dB max. (-30~+85°C)
Insertion loss at 1570 - 1580 MHz	0.70 dB max. (+25°C)
	0.80 dB max. (-30~+85°C)
Insertion loss at 1580 - 1610 MHz	0.70 dB max. (+25°C)
	0.80 dB max. (-30~+85°C)
V.S.W.R. at 1558 - 1570 MHz	1.6 max.
V.S.W.R. at 1570 - 1580 MHz	1.6 max.
V.S.W.R. at 1580 - 1610 MHz	1.6 max.
Attenuation	35 dB min. (698 - 824 MHz)
	42 dB min. (824 - 894 MHz)
	25 dB min. (894 - 960 MHz)
Impedance	50 Ω

FI 168P157519

Low band	
Pass band frequency 0	824 - 960 MHz
Pass band frequency 1	1558 - 1585 MHz
Pass band frequency 2	1585 - 1610 MHz
Insertion loss at 824 - 960 MHz	0.50 dB max. (+25°C)
	0.60 dB max. (-40~+85°C)
Insertion loss at 1558 - 1585 MHz	0.40 dB max. (+25°C)
	0.50 dB max. (-40~+85°C)
Insertion loss at 1585 - 1610 MHz	0.45 dB max. (+25°C)
	0.55 dB max. (-40~+85°C)
V.S.W.R. at 824 - 960 MHz	2.0 max.
V.S.W.R. at 1558 - 1585 MHz	2.0 max.
V.S.W.R. at 1585 - 1610 MHz	2.0 max.
Attenuation	13 dB min. (2400 - 2500 MHz)
Impedance	50 Ω

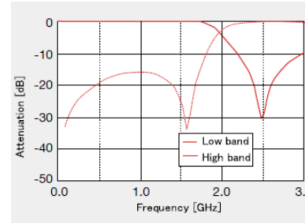

High band	
Pass band frequency	2400 - 2500 MHz
Insertion loss at 2400 - 2500 MHz	0.60 dB max. (+25°C)
	0.70 dB max. (-40~+85°C)
V.S.W.R. at 2400 - 2500 MHz	2.0 max.
Attenuation	12 dB min. (824 - 960 MHz)
	23 dB min. (1558 - 1585 MHz)
	20 dB min. (1585 - 1610 MHz)
Impedance	50 Ω

FI 168P157525

Low band	
Pass band frequency 0	824 - 960 MHz
Pass band frequency 1	1558 - 1585 MHz
Pass band frequency 2	1585 - 1610 MHz
Insertion loss at 824 - 960 MHz	0.50 dB max. (+25°C)
	0.60 dB max. (-40~+85°C)
Insertion loss at 1558 - 1585 MHz	0.40 dB max. (+25°C)
	0.50 dB max. (-40~+85°C)
Insertion loss at 1585 - 1610 MHz	0.45 dB max. (+25°C)
	0.55 dB max. (-40~+85°C)
V.S.W.R. at 824 - 960 MHz	2.0 max.
V.S.W.R. at 1558 - 1585 MHz	2.0 max.
V.S.W.R. at 1585 - 1610 MHz	2.0 max.
Attenuation	13 dB min. (2400 - 2500 MHz)
Impedance	50 Ω

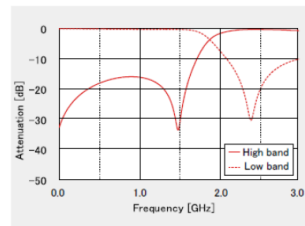

High band	
Pass band frequency	2400 - 2500 MHz
Insertion loss at 2400 - 2500 MHz	0.60 dB max. (+25°C)
	0.70 dB max. (-40~+85°C)
V.S.W.R. at 2400 - 2500 MHz	2.0 max.
Attenuation	12 dB min. (824 - 960 MHz)
	23 dB min. (1558 - 1585 MHz)
	12 dB min. (1585 - 1610 MHz)
Impedance	50 Ω

▶ This catalog contains the typical specification only due to the limitation of space. When you consider the purchase of our products, please check our product specification sheets. For details of each product (characteristics graph, reliability information, precautions for use, and so on), see our website (<http://www.ty-top.com/>).

FI 168WI697B1

Pass band frequency	699 – 2690 MHz
Insertion loss at 699 – 960 MHz	0.15 dB max. (+35~+85°C)
	0.1 dB max. (+15~+35°C)
	0.1 dB max. (-20~+15°C)
Insertion loss at 1000 – 2025 MHz	0.25 dB max. (+35~+85°C)
	0.2 dB max. (+15~+35°C)
	0.2 dB max. (-20~+15°C)
Insertion loss at 2110 – 2690 MHz	0.38 dB max. (+35~+85°C)
	0.28 dB max. (+15~+35°C)
	0.28 dB max. (-20~+15°C)
Ripple	0.1 dB max. (699 – 746 MHz)
	0.1 dB max. (791 – 862 MHz)
	0.1 dB max. (824 – 960 MHz)
	0.1 dB max. (1710 – 2170 MHz)
	0.1 dB max. (2500 – 2690 MHz)
RF Coupling	28.1~29.5 dB (699MHz)
	25.8~27.2 dB (915MHz)
	20.7~22.1 dB (1710MHz)
	19.9~21.3 dB (1880MHz)
	19.3~20.7 dB (2025MHz)
	18.3~19.7 dB (2300MHz)
Coupling ratio mismatch between Coupler branch 1 and Coupler branch 2	17.1~18.5 dB (2690MHz)
	-1~1 dB (699 – 2690 MHz)
Directivity	18 dB min. (699 – 2690 MHz)
Impedance	50 Ω

MULTILAYER CERAMIC DEVICES / DIPLEXERS / 2 BRANCH COUPLER

PACKAGING

① Minimum Quantity

Type	Embossed tape / Paper tape [pcs]
212B	3000
212L	
212C	
212P	
168B	4000
168L	
168D	
168P	
168L-G Series	5000
168W	8000
105B	10000
105L	

② Tape Material

● Embossed Tape

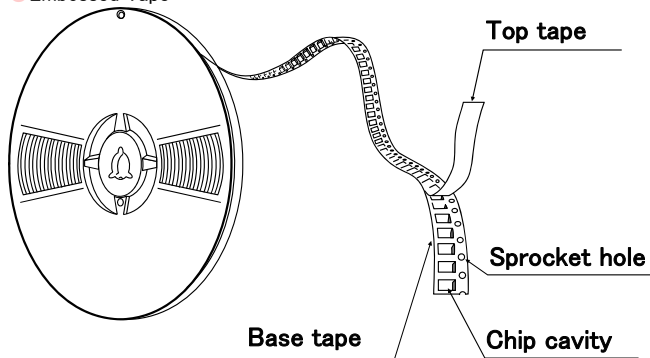

● Card Board Carrier Tape

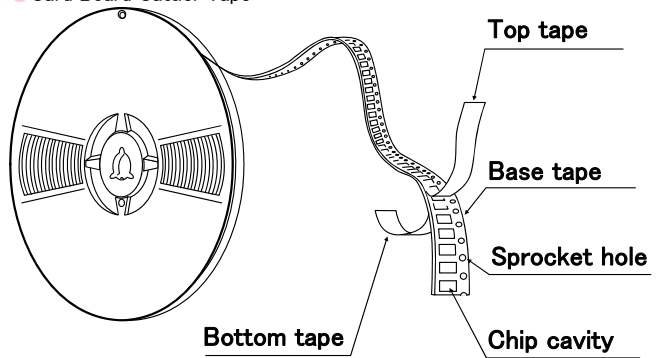

Chip Filled

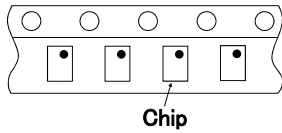

● Taped package

Type (EIA)	Thickness mm (inch)	Standard Quantity [pcs]
212B	0.90 typ.(0.035)	3000
212L	0.45 typ.(0.018)	
212C	0.90 typ.(0.035)	
212P	0.90 typ.(0.035)	
212C-0.5	0.45 typ.(0.018)	
212C-0.7	0.60 typ.(0.024)	
168B	0.45 typ.(0.018)	4000
168L-0.5	0.45 typ.(0.018)	
168L-0.65	0.60 typ.(0.024)	
168D	0.45 typ.(0.018)	
168P	0.60 typ.(0.024)	
168L-G Series	0.60 typ.(0.024)	5000
168W	0.45 typ.(0.018)	8000
105B	0.30 typ.(0.0118)	10000
105L	0.30 typ.(0.0118)	

▶ This catalog contains the typical specification only due to the limitation of space. When you consider the purchase of our products, please check our specification. For details of each product (characteristics graph, reliability information, precautions for use, and so on), see our Web site (<http://www.ty-top.com/>).

③ Taping Dimensions

● Embossed tape 0.315 inches wide
(212B Type, 212C Type, 212C-0.7 Type, 212P Type)

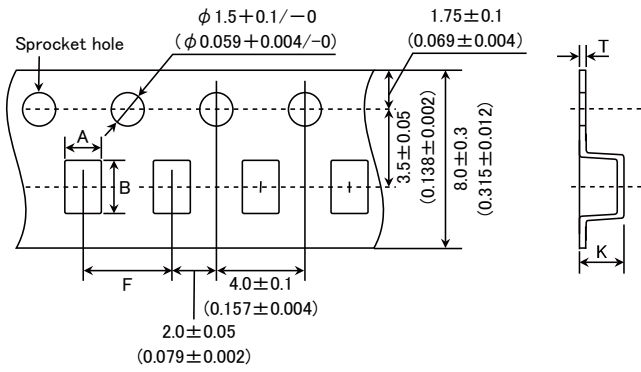

Unit: mm (inch)

Type (EIA)	Chip cavity		Insertion Pitch F	Tape Thickness max.	
	A	B		K	T
212B	1.55 ± 0.2 (0.061 ± 0.008)	2.3 ± 0.2 (0.091 ± 0.008)	4.0 ± 0.1 (0.157 ± 0.004)	1.6 (0.063)	0.3 (0.012)
212C	1.55 ± 0.2 (0.061 ± 0.008)	2.3 ± 0.2 (0.091 ± 0.008)	4.0 ± 0.1 (0.157 ± 0.004)	1.6 (0.063)	0.3 (0.012)
212C-0.7	1.55 ± 0.2 (0.061 ± 0.008)	2.3 ± 0.2 (0.091 ± 0.008)	4.0 ± 0.1 (0.157 ± 0.004)	1.3 (0.051)	0.3 (0.012)
212P	1.55 ± 0.2 (0.061 ± 0.008)	2.3 ± 0.2 (0.091 ± 0.008)	4.0 ± 0.1 (0.157 ± 0.004)	1.6 (0.063)	0.3 (0.012)

Unit: mm (inch)

● Paper tape 0.315 inches wide
(212L Type, 212C-0.5 Type, 168B Type, 168L Type, 168W Type, 168D Type, 168P Type, 168L-G Series, 105B Type, 105L Type)

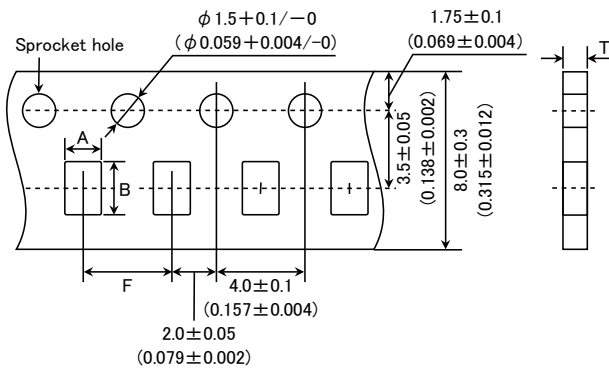

Unit: mm (inch)

Type (EIA)	Chip cavity		Insertion Pitch F	Tape Thickness max. T
	A	B		
212L	1.55 ± 0.2 (0.061 ± 0.008)	2.3 ± 0.2 (0.091 ± 0.008)	4.0 ± 0.1 (0.157 ± 0.004)	0.65 (0.026)
212C-0.5	1.55 ± 0.2 (0.061 ± 0.008)	2.3 ± 0.2 (0.091 ± 0.008)	4.0 ± 0.1 (0.157 ± 0.004)	0.3 (0.012)
168B	1.00 ± 0.05 (0.039 ± 0.002)	1.80 ± 0.05 (0.071 ± 0.002)	4.0 ± 0.1 (0.157 ± 0.004)	0.55 (0.022)
168L	1.00 ± 0.05 (0.039 ± 0.002)	1.80 ± 0.05 (0.071 ± 0.002)	4.0 ± 0.1 (0.157 ± 0.004)	0.55 (0.022)
168W	1.00 ± 0.05 (0.039 ± 0.002)	1.80 ± 0.05 (0.071 ± 0.002)	4.0 ± 0.1 (0.157 ± 0.004)	0.55 (0.022)
168D	1.00 ± 0.05 (0.039 ± 0.002)	1.80 ± 0.05 (0.071 ± 0.002)	4.0 ± 0.1 (0.157 ± 0.004)	0.55 (0.022)
168P, 168L-G Series	0.95 ± 0.05 (0.037 ± 0.002)	1.80 ± 0.05 (0.071 ± 0.002)	4.0 ± 0.1 (0.157 ± 0.004)	0.80 (0.031)
105B	0.62 ± 0.03 (0.024 ± 0.001)	1.12 ± 0.03 (0.044 ± 0.001)	2.0 ± 0.05 (0.079 ± 0.002)	0.45 (0.018)
105L	0.62 ± 0.03 (0.024 ± 0.001)	1.12 ± 0.03 (0.044 ± 0.001)	2.0 ± 0.05 (0.079 ± 0.002)	0.45 (0.018)

Unit: mm (inch)

④ Leader and Blank Portion



⑤ Reel size

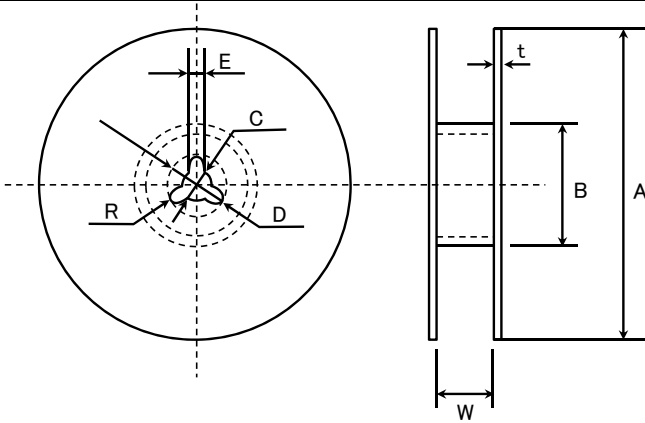

A	B	C	D	E	R
$\phi 178 \pm 2.0$ ($\phi 7.01 \pm 0.079$)	$\phi 60 \text{ min.}$ ($\phi 1.97 \text{ min.}$)	$\phi 13.0 \pm 0.2$ ($\phi 0.512 \pm 0.008$)	$\phi 21.0 \pm 0.8$ ($\phi 0.827 \pm 0.031$)	2.0 ± 0.5 (0.079 ± 0.020)	1.0
	t	W			
8mm width tape (0.315 inches width)	2.5max. (0.098max.)	10 ± 1.5 (0.394 ± 0.059)			
12mm width tape (0.472 inches width)	2.5max. (0.098max.)	14 ± 1.5 (0.551 ± 0.059)			

Unit: mm (inch)

⑥ Top Tape Strength

The top tape requires a peel-off force of 0.1~0.7N in the direction of the arrow as illustrated below.

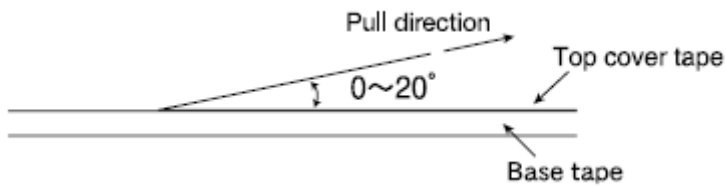

MULTILAYER CERAMIC DEVICES / DIPLEXERS / 2 BRANCH COUPLER

RELIABILITY DATA

1. Operating Temperature Range	
Specified Value	-30~+85°C
2. Storage Temperature Range	
Specified Value	-30~+85°C
Test Methods and Remarks	※Note : -20 to +40°C in taped packaging
3. Resistance to Flexure of Substrate	
Specified Value	No mechanical damage.
Test Methods and Remarks	<p>Warp : 2mm Testing board : Glass epoxy-resin substrate Thickness : 0.8mm</p>  <p>[Unit: mm]</p>
4. Adhesion of Electrode	
Specified Value	Characteristics : shall satisfy the electrical characteristics. Appearance : No significant abnormality.
Test Methods and Remarks	<p>Applied force : 5N Duration : 10 sec.</p>  <p>Cross-section</p>
5. Solderability	
Specified Value	75% or more of immersed surface of terminal electrode shall be covered with fresh solder.
Test Methods and Remarks	<p>Solder temperature : 230±5°C Duration : 4±1 sec Preconditioning : Immersion into flux. Immersion and Removal speed : 25mm/sec.</p>
6. Resistance to Solder Heat	
Specified Value	Characteristics : shall satisfy the electrical characteristics. Appearance : No significant abnormality.
Test Methods and Remarks	<p>Preheating : 150°C for 2 min. Solder temperature : 260±5°C Duration : 5±0.5 sec. Preconditioning : Immersion into flux. Immersion and Removal speed : 25mm/sec. Recovery : 2 to 3hrs of recovery under the standard condition after the removal from test chamber.</p>

▶ This catalog contains the typical specification only due to the limitation of space. When you consider the purchase of our products, please check our specification. For details of each product (characteristics graph, reliability information, precautions for use, and so on), see our Web site (<http://www.ty-top.com/>).

7. Thermal Shock																
Specified Value	Characteristics : shall satisfy the electrical characteristics. Appearance : No significant abnormality.															
Test Methods and Remarks	According to JIS C60068-2-14. Conditions for 1 cycle															
	<table border="1"> <thead> <tr> <th>Step</th> <th>Temperature (°C)</th> <th>Duration (min)</th> </tr> </thead> <tbody> <tr> <td>1</td> <td>-40±3</td> <td>30±3</td> </tr> <tr> <td>2</td> <td>Room Temperature</td> <td>Within 3</td> </tr> <tr> <td>3</td> <td>85±2</td> <td>30±3</td> </tr> <tr> <td>4</td> <td>Room Temperature</td> <td>Within 3</td> </tr> </tbody> </table>	Step	Temperature (°C)	Duration (min)	1	-40±3	30±3	2	Room Temperature	Within 3	3	85±2	30±3	4	Room Temperature	Within 3
	Step	Temperature (°C)	Duration (min)													
	1	-40±3	30±3													
	2	Room Temperature	Within 3													
3	85±2	30±3														
4	Room Temperature	Within 3														
Number of cycles : 100																
Mounting method : Soldering onto PC board. Recovery : 2 to 3hrs of recovery under the standard condition after the removal from test chamber.																

8. Humidity (steady state)	
Specified Value	Characteristics : shall satisfy the electrical characteristics. Appearance : No significant abnormality.
Test Methods and Remarks	Temperature : +40±2°C Humidity : 90~95%RH Duration : 96hrs Recovery : 2 to 3hrs of recovery under the standard condition after the removal from test chamber.

9. High temperature life test	
Specified Value	Characteristics : shall satisfy the electrical characteristics. Appearance : No significant abnormality.
Test Methods and Remarks	Temperature : +85±2°C Duration : 96hrs Recovery : 2 to 3hrs of recovery under the standard condition after the removal from test chamber.

10. Low temperature life test	
Specified Value	Characteristics : shall satisfy the electrical characteristics. Appearance : No significant abnormality.
Test Methods and Remarks	Temperature : -40±2°C Duration : 96hrs Recovery : 2 to 3hrs of recovery under the standard condition after the removal from test chamber.

Note on standard condition:

“standard condition” referred to herein is defined as follows :
5 to 35°C of temperature, 45 to 85% relative humidity and 86 to 106kPa of air pressure.

When there are questions concerning measurement result :

In order to provide correlation data, the test shall be conducted under condition of 20±2°C of temperature, 60 to 70% relative humidity and 86 to 106kPa of air pressure.

Unless otherwise specified, all the tests are conducted under the “standard condition”.

MULTILAYER CERAMIC DEVICES / DIPLEXERS / 2 BRANCH COUPLER

PRECAUTIONS

1. PCB Design

◆ Land pattern design

Land pattern dimension examples

Technical considerations

<p>FI212B Type</p> <p>Unit: mm</p>	<p>FI212B245025 FI212B190223</p> <p>Unit: mm</p>	<p>FI212L Type</p> <p>Unit: mm</p>	<p>FI168D Type</p> <p>Unit: mm</p>
<p>FI168B/L Type</p> <p>Unit: mm</p>	<p>FI168P Type</p> <p>Unit: mm</p>	<p>FI212C Type</p> <p>Unit: mm</p>	<p>FI212P Type</p> <p>Unit: mm</p>
<p>FI212 P3960A4</p> <p>Unit: mm</p>	<p>FI105B/L Type</p> <p>Unit: mm</p>	<p>FI168W Type</p> <p>Unit: mm</p>	<p>FI212P***G* Type</p> <p>単位: mm</p>

2. Soldering

◆ Conditions for Reflow soldering (for reference)

【Reflow Profile】

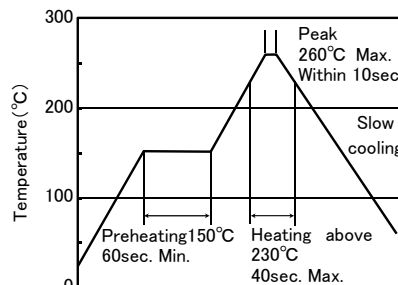
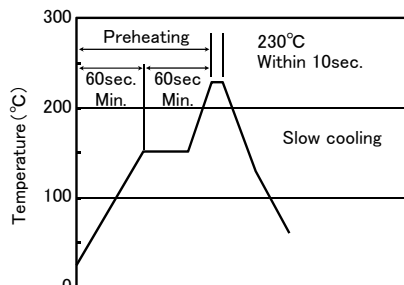

- ※ Components should be preheated to within 100 to 130°C from soldering temperature.
- ※ Assured to be reflow soldering for 2 times.

Note : The above profiles are the maximum allowable soldering condition, therefore these profiles are not always recommended.

Technical considerations

3. Storage conditions

Precautions	<p>◆Storage</p> <p>1. To maintain the solderability of terminal electrodes and to keep the packaging material in good condition, care must be taken to control temperature and humidity in the storage area. Humidity should especially be kept as low as possible.</p> <ul style="list-style-type: none">• Recommended conditions Ambient temperature : $-20\sim+40^{\circ}\text{C}$ Humidity : Below 70%RH The ambient temperature must be kept below 30°C. Even under ideal storage conditions, the solderability of electrodes decreases gradually, so filters should be mounted within 6 months from the time of delivery.• The packaging material should be kept where no chlorine or sulfur exists in the air.
Technical considerations	<p>◆Storage</p> <p>1. If the parts are stocked in a high temperature and humidity environment, problems such as reduced solderability caused by oxidation of terminal electrodes and deterioration of taping/ packaging materials may take place. For this reason, components should be used within 6 months from the time of delivery. If exceeding the above period, please check the solderability before using the filter.</p>

- Please contact of our offices for further details of specifications.
All of the standard values listed here are subject to change without notice.
Therefore, please check the specifications carefully before use.