



# MIC94305

## 500mA Switch with Ripple Blocker™ Technology



### General Description

The MIC94305 is an integrated load switch that incorporates Micrel's Ripple Blocker active filter technology. The MIC94305 provides high-frequency ripple attenuation (switching noise rejection) for applications where switching noise cannot be tolerated by sensitive downstream circuits, such as RF applications. A low-voltage logic enable pin disconnects the pass element and puts the MIC94305 in a low current-shutdown state when disabled.

The MIC94305 operates from an input voltage of 1.8V to 3.6V, allowing true load switching of low-voltage power rails in any electronic device. The output voltage ( $V_{OUT}$ ) is set at a fixed drop (typically 170mV) from the input voltage ( $V_{OUT} = V_{IN} - 170mV$ ). This maintains high efficiency independent of given load conditions and currents.

The MIC94305 is packaged in a 6-ball 0.84mm x 1.32mm CSP package, or 6-pin 1.6mm x 1.6mm Thin DFN package, and has a junction operating temperature range of  $-40^{\circ}C$  to  $+125^{\circ}C$ .

Data sheets and support documentation can be found on Micrel's web site at: [www.micrel.com](http://www.micrel.com).

### Features

- 1.8V to 3.6V input voltage range
- Active noise rejection over a wide frequency band –  $>60dB$  from 40kHz to 5MHz
- Rated to 500mA output current
- Current-limit and thermal-limit protected
- Ultra-small 0.84mm x 1.32mm, 6-ball CSP
- 1.6mm x 1.6mm, 6-pin Thin DFN
- Logic-controlled enable pin
- $-40^{\circ}C$  to  $+125^{\circ}C$  junction temperature range

### Applications

- Smart phones
- Tablet PC/notebooks and webcams
- Digital still and video cameras
- Videoconferencing
- Bar-code scanners
- Global positioning systems
- Automotive and industrial applications

### Typical Application

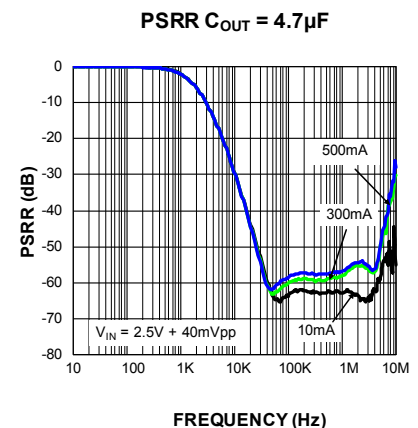
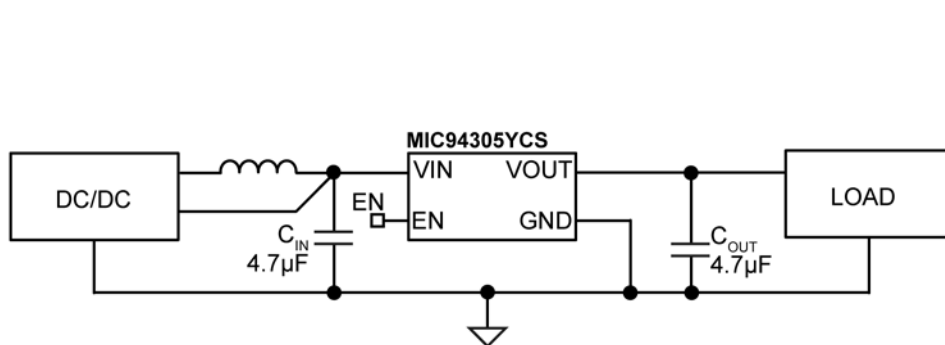

Ripple Blocker is a trademark of Micrel, Inc

Micrel Inc. • 2180 Fortune Drive • San Jose, CA 95131 • USA • tel +1 (408) 944-0800 • fax + 1 (408) 474-1000 • <http://www.micrel.com>

## Ordering Information

Part Number	Marking Code	Package	Lead Finish
MIC94305YCS*	W1	0.84mm × 1.32mm WLCSP	Pb-Free
MIC94305YMT <sup>1</sup>	2W	1.6mm × 1.6mm Thin DFN	Pb-Free

**Notes:**

- Thin DFN is a GREEN RoHS-compliant package. Lead finish is NiPdAu. Mold compound is Halogen Free.
- \* Contact Micrel Marketing for availability.

## Pin Configuration

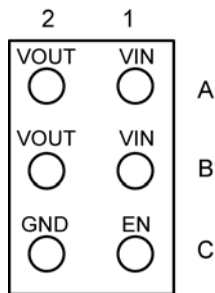

**6-Ball 0.84mm × 1.32mm CSP (CS)**  
Ball View

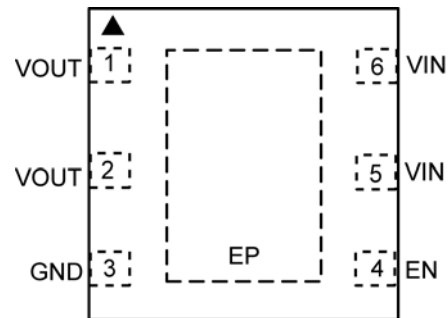

**6-Pin 1.6mm × 1.6mm Thin DFN (MT)**  
Top View

**Note:**

- Thin DFN ▲ = Pin 1 identifier.

## Pin Description

Pin Number (Thin DFN)	Ball Number (CSP)	Pin Name	Pin Name
1, 2	A2, B2	VOUT	Power switch output.
3	C2	GND	Ground.
4	C1	EN	Enable input. A logic HIGH signal on this pin enables the part. Logic LOW disables the output. Do not leave floating.
5, 6	A1, B1	VIN	Power switch input and chip supply.
EP	–	ePad	Exposed heatsink pad. Connect to Ground for best thermal performance.

### Functional Block Diagram

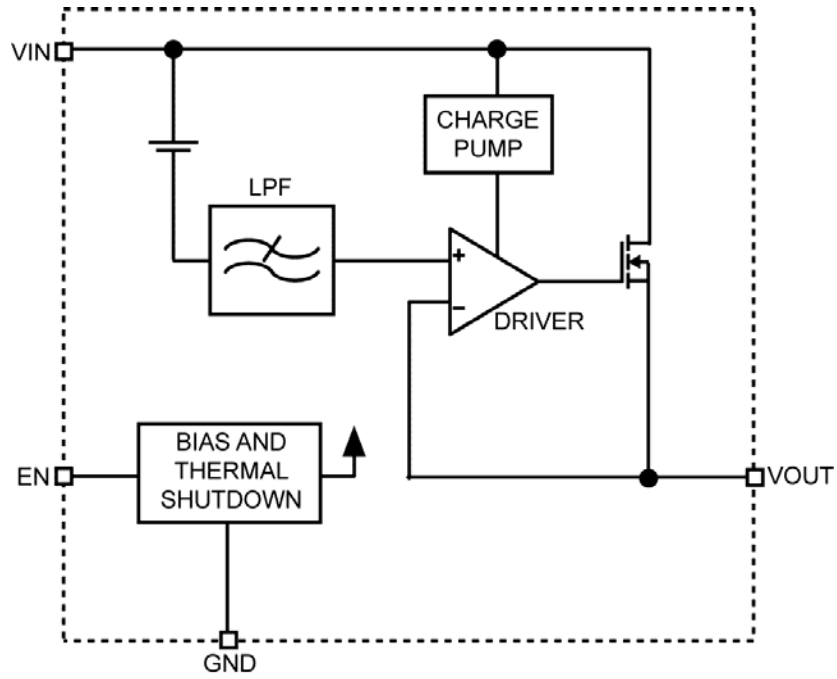

MIC94305 Block Diagram

**Absolute Maximum Ratings<sup>(1)</sup>**

Input Voltage ( $V_{IN}$ )	-0.3V to +4V
Output Voltage ( $V_{OUT}$ )	-0.3V to +4V
Enable Voltage ( $V_{EN}$ )	-0.3V to $V_{IN} + 0.3V$ or +4V
Lead Temperature (soldering, 10s)	260°C
Storage Temperature ( $T_S$ )	-65°C to +150°C
ESD Rating <sup>(3)</sup>	3kV

**Operating Ratings<sup>(2)</sup>**

Input Voltage ( $V_{IN}$ )	+1.8V to +3.6V
Enable Voltage ( $V_{EN}$ )	0V to $V_{IN}$
Junction Temperature ( $T_J$ )	-40°C to +125°C
Junction Thermal Resistance	
0.84mm x 1.32mm WLCSP ( $\theta_{JA}$ )	160°C/W
1.6mm x 1.6mm Thin DFN ( $\theta_{JA}$ )	92°C/W

**Electrical Characteristics<sup>(4)</sup>**

$V_{IN} = V_{EN} = 3.6V$ ;  $I_{OUT} = 1mA$ ;  $C_{OUT} = 4.7\mu F$ ;  $T_A = 25^\circ C$ , **bold** values indicate  $-40^\circ C \leq T_J \leq +125^\circ C$ , unless noted.

Parameter	Condition	Min.	Typ.	Max.	Units
Input Voltage		<b>1.8</b>		<b>3.6</b>	V
Voltage Drop	$V_{IN} - V_{OUT}$ , $-40^\circ C \leq T_J \leq +85^\circ C$		170	<b>250</b>	mV
$V_{IN}$ Ripple Rejection (PSRR)	$f = 20kHz$ , $I_{OUT} = 500mA$		45		dB
	$f = 100kHz$ to $5MHz$ , $I_{OUT} = 500mA$		55		
Total Output Noise	$f = 10Hz$ to $100kHz$		98		$\mu V_{RMS}$
Current Limit	$V_{OUT} = 0V$	<b>530</b>	725	<b>1100</b>	mA
Turn-On Time	EN controlled		90	<b>150</b>	$\mu s$
Load Regulation	100 $\mu A$ to 100mA		10		mV
Ground Current	$I_{OUT} = 100\mu A$		150	200	$\mu A$
Shutdown Current	$V_{EN} = 0V$		0.2	5	$\mu A$
<b>Enable</b>					
Input Logic LOW				<b>0.4</b>	V
Input Logic HIGH		<b>1.0</b>			V
Input Current			0.01	1	$\mu A$

**Notes:**

- Exceeding the absolute maximum rating may damage the device.
- The device is not guaranteed to function outside its operating rating.
- Devices are ESD sensitive. Handling precautions are recommended. Human body model, 1.5k $\Omega$  in series with 100pF.
- Specification for packaged product only.

# Typical Characteristics

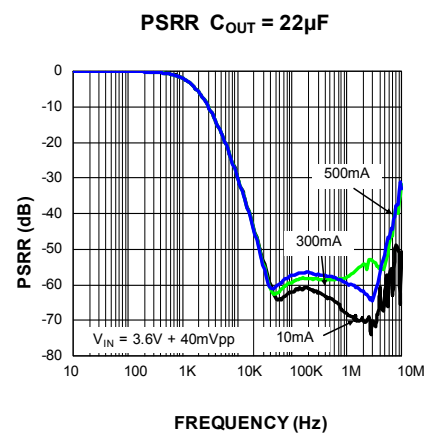
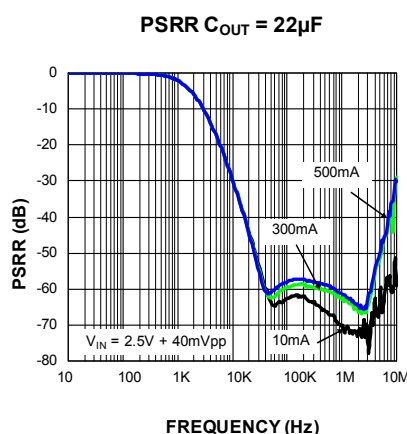
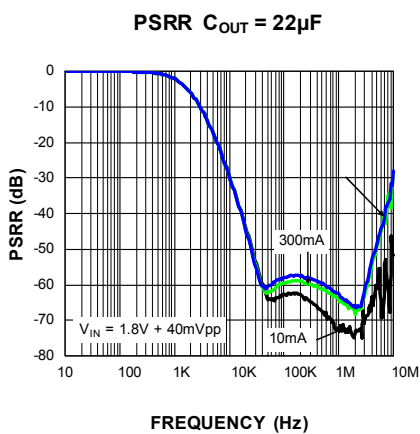
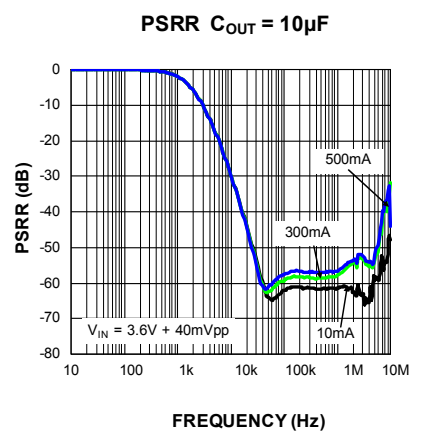
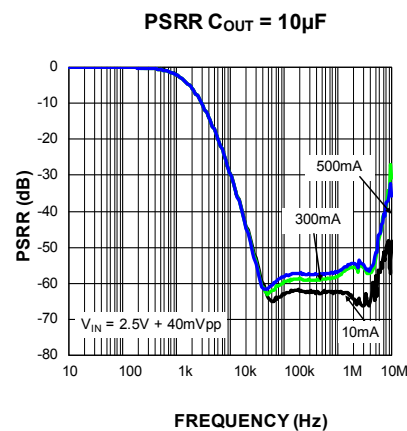
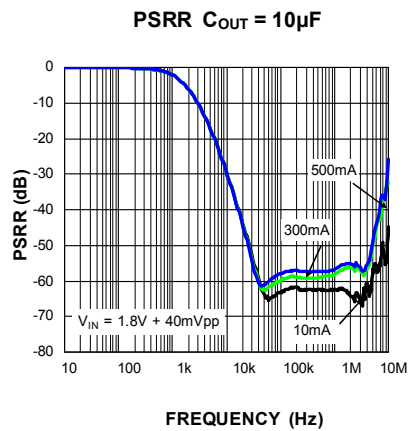
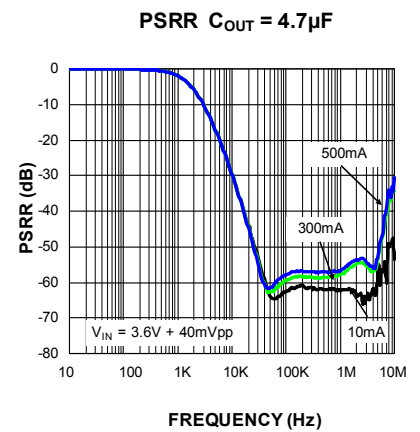
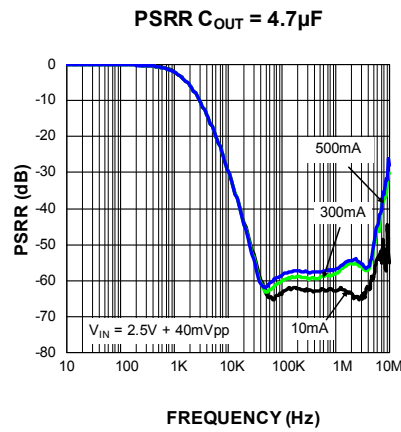
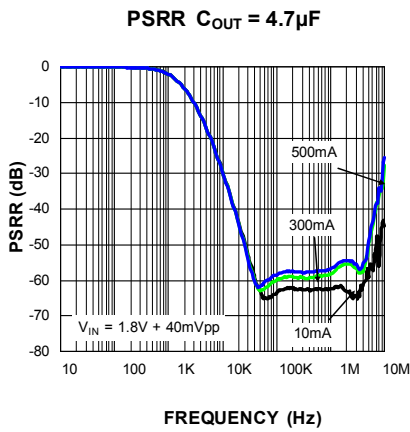

Typical Characteristics (Continued)

Output Voltage vs. Output Current

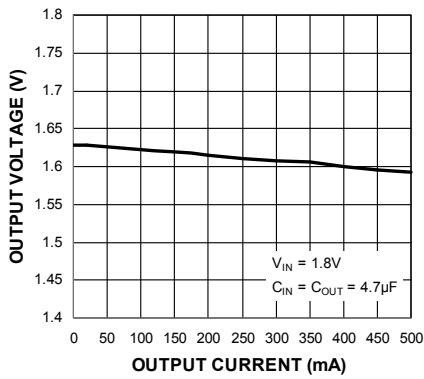

Output Voltage vs. Output Current

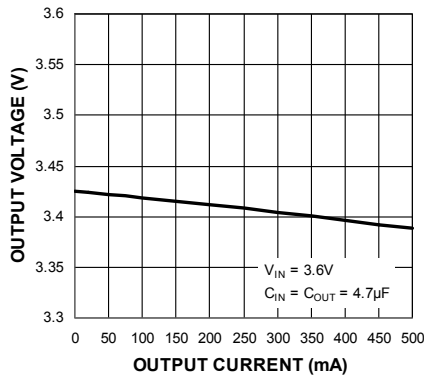

Voltage Drop vs. Output Current

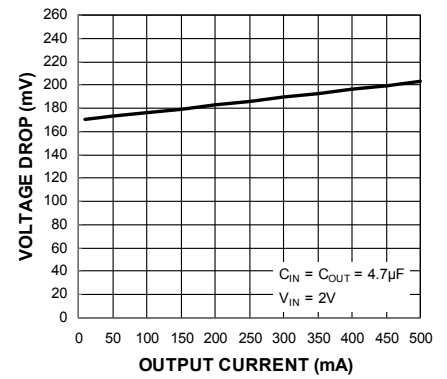

Voltage Drop vs. Input Voltage

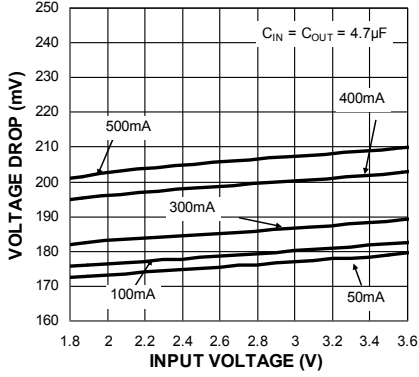

Ground Current vs. Output Current

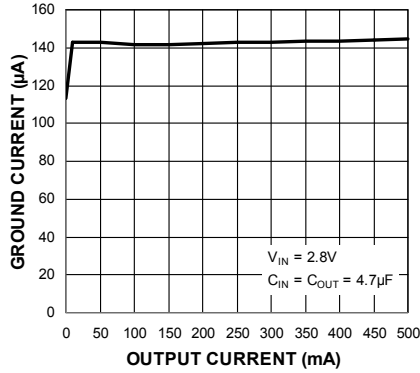

Ground Current vs. Input Voltage

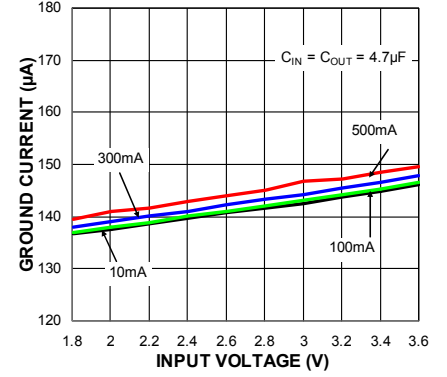

MIC94305YMT  
Output Noise Spectral Density

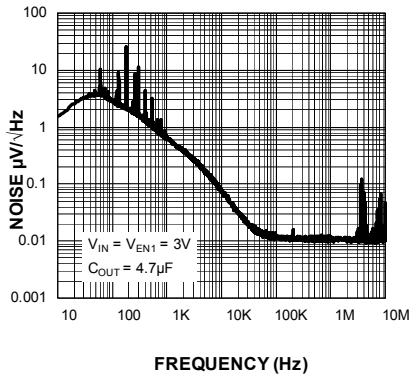

## Functional Characteristics

**Load Transient**

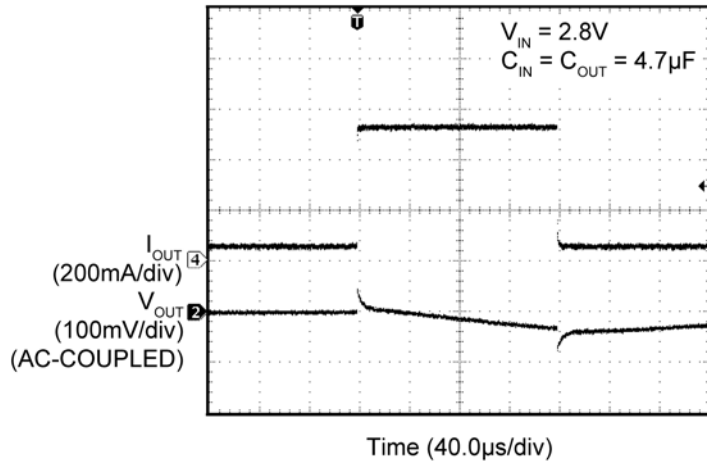

**Line Transient**

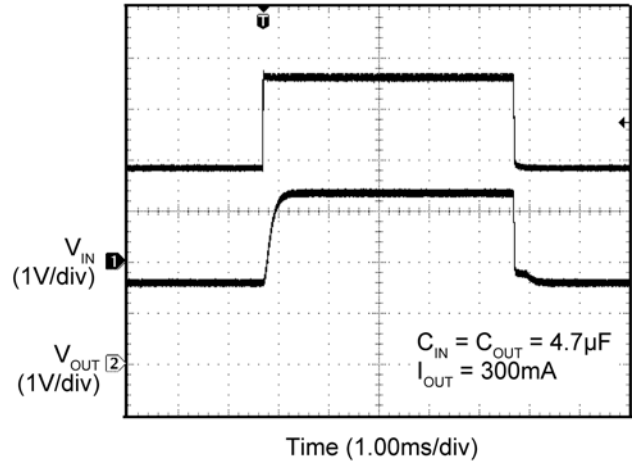

**Enable Turn-Off**

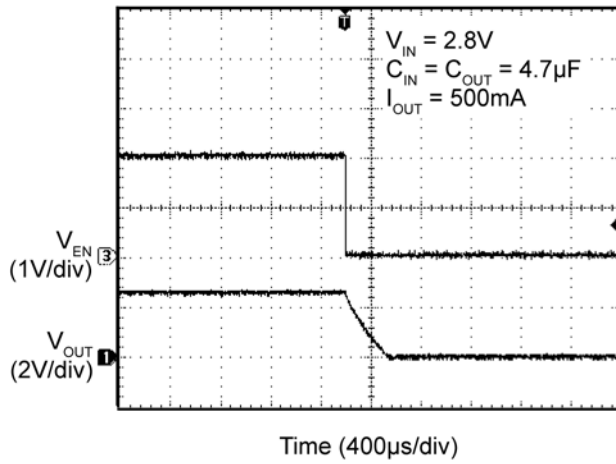

**Enable Turn-On**

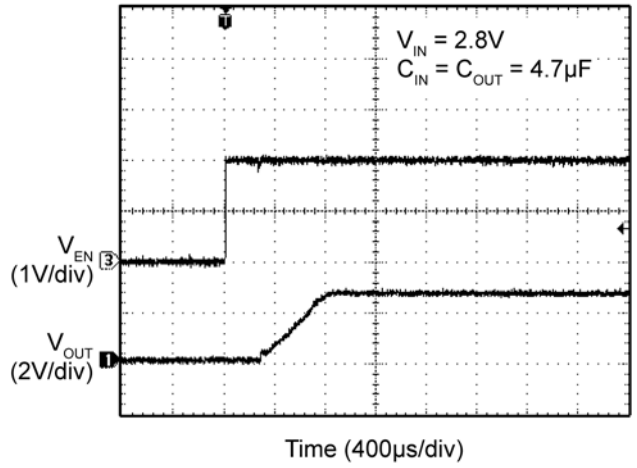

## Application Information

The MIC94305 uses Ripple Blocker technology to integrate a load switch with a high-performance active filter. The MIC94305 includes a low-voltage logic enable pin, and is fully protected from damage caused by fault conditions, offering linear current limiting and thermal shutdown.

### Input Capacitor

The MIC94305 is a high-performance, high-bandwidth device. An input capacitor of 4.7 $\mu$ F from the input to ground is required to provide stability. Low-ESR ceramic capacitors provide optimal performance using a minimum of space. Additional high-frequency capacitors, such as small-valued NPO dielectric-type capacitors, help filter out high-frequency noise and are good practice in any RF-based circuit. X5R or X7R dielectrics are recommended for the input capacitor. Y5V dielectrics lose most of their capacitance over temperature and are not recommended.

### Output Capacitor

The MIC94305 requires an output capacitor of 4.7 $\mu$ F or greater to maintain stability. For optimal ripple rejection performance, a 4.7 $\mu$ F capacitor is recommended. The design is optimized for use with low-ESR ceramic-chip capacitors. High-ESR capacitors are not recommended because they may cause high-frequency oscillation. The output capacitor can be increased, but performance has been optimized for a 4.7 $\mu$ F ceramic output capacitor and does not improve significantly with larger capacitance.

X7R/X5R dielectric-type ceramic capacitors are recommended because of their temperature performance. X7R-type capacitors change capacitance by 15% over their operating temperature range and are the most stable type of ceramic capacitors. Z5U and Y5V dielectric capacitors change value by as much as 50% and 60%, respectively, over their operating temperature ranges. If you use a ceramic-chip capacitor with a Y5V dielectric, the value must be much higher than an X7R ceramic capacitor to ensure the same minimum capacitance over the equivalent operating temperature range.

### No Load Stability

The MIC94305 will remain stable with no load. This is especially important in CMOS RAM keep-alive applications.

### Enable/Shutdown

The MIC94305 comes with an active-high enable pin that allows the Ripple Blocker to be disabled. Forcing the enable pin low disables the MIC94305 and sends it into a “zero” off mode current state. In this state, current consumed by the MIC94305 goes to nearly zero. Forcing the enable pin high enables the output voltage. The active-high enable pin uses CMOS technology and cannot be left floating; a floating enable pin may cause an indeterminate state on the output.

### Thermal Considerations

The MIC94305 is designed to provide 500mA of continuous current in a very small package. Maximum ambient operating temperature can be calculated based on the output current and the voltage drop across the part, which is fixed at 170mV typical, 250mV worst case. For example, if the input voltage is 2.75V, the output voltage is 2.5V, and the output current is 500mA. The actual power dissipation of the Ripple Blocker™ can be determined using the equation:

$$P_D = (V_{IN} - V_{OUT}) I_{OUT} + V_{IN} I_{GND}$$

Because this device is CMOS and the ground current is typically <100 $\mu$ A over the load range, the power dissipation contributed by the ground current is <1% and can be ignored for this calculation:

$$P_D = (2.75V - 2.5V) \times 500mA$$

$$P_D = 0.125W$$

To determine the package's maximum ambient operating temperature, use the junction-to-ambient thermal resistance of the device and the following basic equation:

$$P_{D(MAX)} = \left( \frac{T_{J(MAX)} - T_A}{\theta_{JA}} \right)$$

$T_{J(MAX)} = 125^\circ\text{C}$ , the maximum junction temperature of the die;  $\theta_{JA}$  thermal resistance = 160 $^\circ\text{C/W}$  for the YCS package, and 92 $^\circ\text{C/W}$  for the YMT package.



Substituting  $P_D$  for  $P_{D(MAX)}$  and solving for the ambient operating temperature gives the maximum operating conditions for the regulator circuit.

For proper operation, do not exceed the maximum power dissipation.

For example, when operating the MIC94305YMT at a 2.75V input voltage and 500mA load with a minimum footprint layout, the maximum ambient operating temperature  $T_A$  can be determined as follows:

$$0.125W = (125^{\circ}C - T_A)/(92^{\circ}C/W)$$
$$T_A = 113.5^{\circ}C$$

It follows from this equation that the maximum ambient operating temperature of 113.5°C is allowed in a 1.6mm x 1.6mm DFN package. For a full discussion of heat sinking and thermal effects on voltage regulators, refer to the "Regulator Thermals" section of Micrel's *Designing with Low-Dropout Voltage Regulators* handbook. This information can be found on Micrel's website at:

[http://www.micrel.com/PDF/other/LDOBk\\_ds.pdf](http://www.micrel.com/PDF/other/LDOBk_ds.pdf)

For more information about Micrel's Ripple Blocker products, go to:

<http://www.micrel.com/rippleblocker/>

<http://www.micrel.com/page.do?page=/product-info/products/mic94300.jsp>

<http://www.micrel.com/page.do?page=/product-info/products/mic94310.jsp>

## Typical Application Schematic

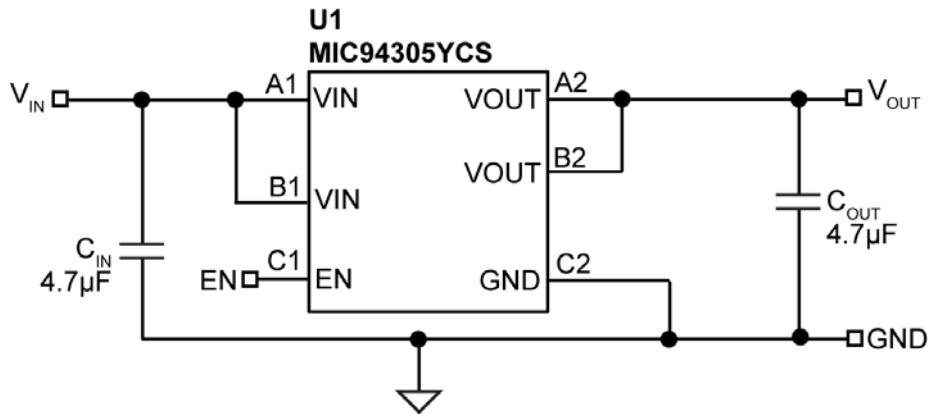

## Bill of Materials

Item	Part Number	Manufacturer	Description	Qty.
C <sub>IN</sub> , C <sub>OUT</sub>	C1005X5R1A475K	TDK <sup>(1)</sup>	Capacitor, 4.7µF Ceramic, 10V, X7R, Size 0603	2
U1	MIC94305YCS	Micrel, Inc. <sup>(2)</sup>	500mA Switch with Ripple Blocker Technology	1

**Notes:**

1. TDK: [www.tdk.com](http://www.tdk.com).
2. Micrel, Inc.: [www.micrel.com](http://www.micrel.com).

# Package Information<sup>(1)</sup>

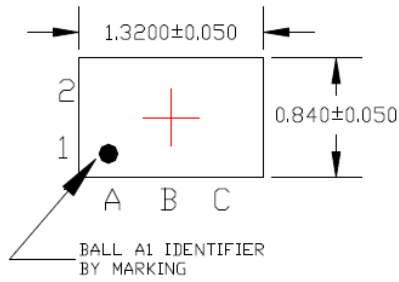

TOP VIEW  
NOTE: 1, 2

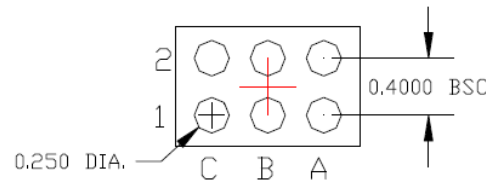

BOTTOM VIEW  
NOTE: 1, 2

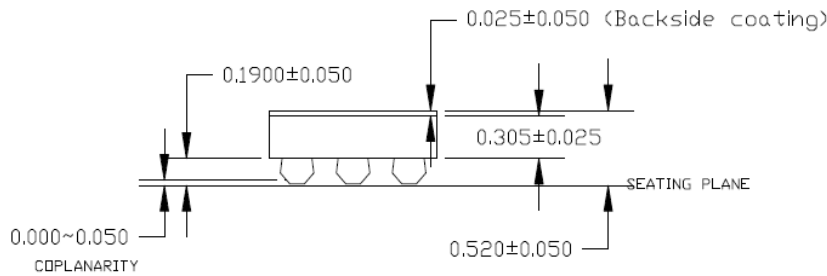

SIDE VIEW  
NOTE: 1, 2

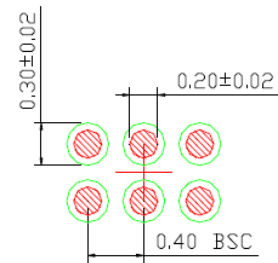

RECOMMENDED LAND PATTERN  
NOTE: 3, 4

**NOTE:**

1. MAX PACKAGE WARPAGE IS 0.05 MM
2. MAX ALLOWABLE BURR IS 0.076MM IN ALL DIRECTIONS
3. NON-SOLDERMASK DEFINED PADS ARE RECOMMENDED FOR BOARD LAYOUT
4. SHADED RED CIRCLES REPRESENT CONTACT PAD AREA, GREEN CIRCLES REPRESENT SOLDER MASK OPENING

**6-Ball 0.84mm × 1.32mm WL-CSP (CS)**

**Note:**

1. Package information is correct as of the publication date. For updates and most current information, go to [www.micrel.com](http://www.micrel.com).

Package Information<sup>(1)</sup> (Continued)

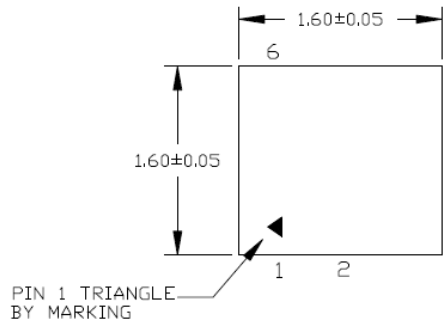

TOP VIEW  
NOTE: 1, 2, 3

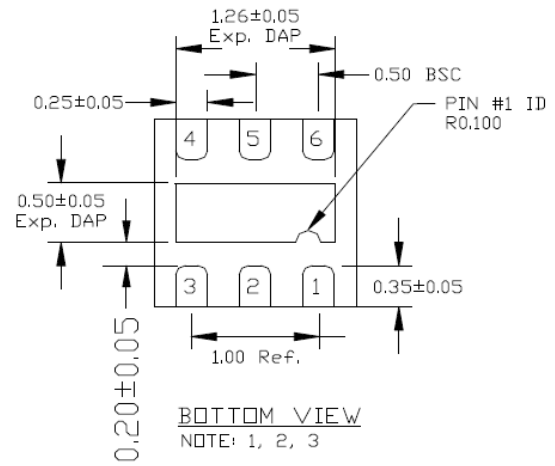

BOTTOM VIEW  
NOTE: 1, 2, 3

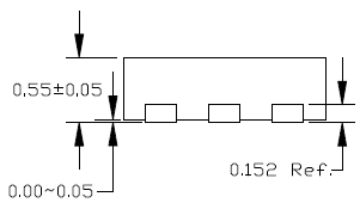

SIDE VIEW  
NOTE: 1, 2, 3

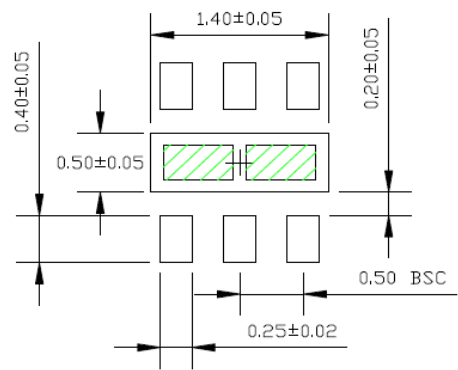

RECOMMENDED LAND PATTERN  
NOTE: 4

- NOTE:
1. MAX PACKAGE WARPAGE IS 0.05 MM
  2. MAX ALLOWABLE BURR IS 0.076MM IN ALL DIRECTIONS
  3. PIN #1 IS ON TOP WILL BE LASER MARKED
  4. GREEN SHADED AREA REPRESENT SOLDER STENCIL OPENING (OPTIONAL) FOR IMPROVED THERMAL PERFORMANCE. SIZE: 0.55x0.30MM

6-Pin 1.6mm x 1.6mm Thin DFN (MT)

---

**MICREL, INC. 2180 FORTUNE DRIVE SAN JOSE, CA 95131 USA**TEL +1 (408) 944-0800 FAX +1 (408) 474-1000 WEB <http://www.micrel.com>

Micrel makes no representations or warranties with respect to the accuracy or completeness of the information furnished in this data sheet. This information is not intended as a warranty and Micrel does not assume responsibility for its use. Micrel reserves the right to change circuitry, specifications and descriptions at any time without notice. No license, whether express, implied, arising by estoppel or otherwise, to any intellectual property rights is granted by this document. Except as provided in Micrel's terms and conditions of sale for such products, Micrel assumes no liability whatsoever, and Micrel disclaims any express or implied warranty relating to the sale and/or use of Micrel products including liability or warranties relating to fitness for a particular purpose, merchantability, or infringement of any patent, copyright or other intellectual property right.

Micrel Products are not designed or authorized for use as components in life support appliances, devices or systems where malfunction of a product can reasonably be expected to result in personal injury. Life support devices or systems are devices or systems that (a) are intended for surgical implant into the body or (b) support or sustain life, and whose failure to perform can be reasonably expected to result in a significant injury to the user. A Purchaser's use or sale of Micrel Products for use in life support appliances, devices or systems is a Purchaser's own risk and Purchaser agrees to fully indemnify Micrel for any damages resulting from such use or sale.

© 2012 Micrel, Incorporated.