

ASMT-Lx50

Flexible Light Strip Module



Data Sheet

Description

Flexible Light Strip Module is high performance light tube produced by Avago Technologies, integrating LEDs solution with excellent thermoplastic polyurethane. This Light Strip is an environmentally friendly "Green Material", it offers a unique combination of mechanical, physical, and chemical properties, including high tensile strength, excellent abrasion resistance, outstanding flexibility, weather resistance, non toxic, recyclable, and decomposable. Flexible Light Strip Module provides conveniences for the designers to integrate light strip onto their devices with minimum consideration on optical and mechanical optimization. The specially designed housing helps to concentrate the light for maximum efficiency and the specially designed PCB provides plug-and-play type of solution for assembly. The total solution provides the ease of design and assembly for designers.

Features

- Outstanding abrasion resistance
- Excellent mechanical properties
- Excellent chemical resistance
- Excellent light transitivity
- High shaping flexibility
- Available length 100mm to 500mm at interval of 1mm
- Available voltage source : 5V, 9V and 12V
- Available color: Blue, Green, Red and White
- Light strip module in circular configuration

Applications

- Handheld devices
- Cellular Phones
- Decorative lighting
- Electronics and electrical appliances

Package Dimensions

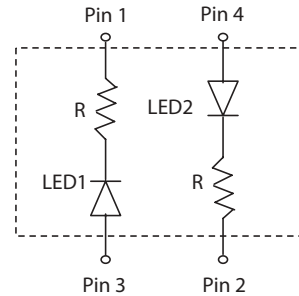
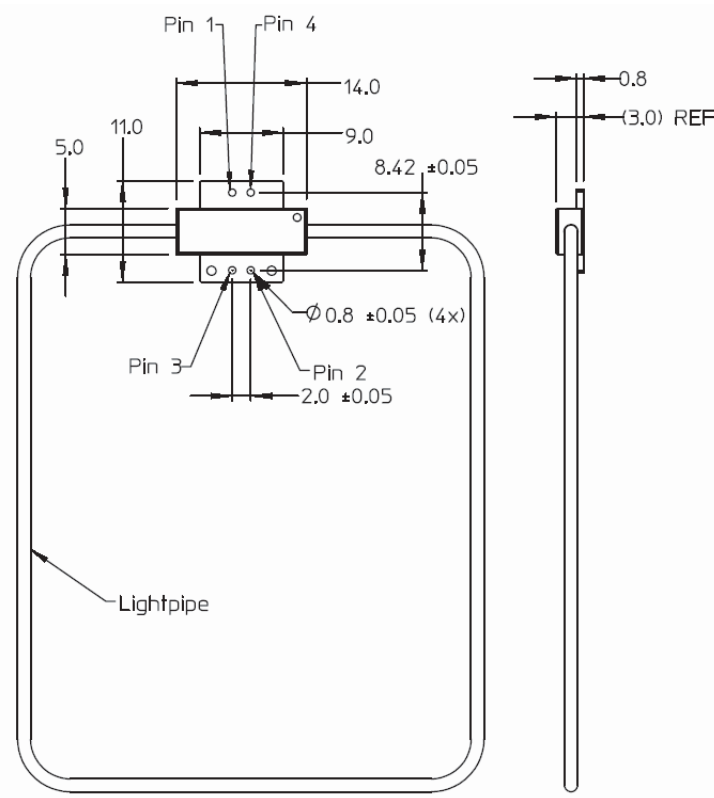

Pin 1	Ground for LED 1
Pin 2	Ground for LED 2
Pin 3	Vcc for LED 1
Pin 4	Vcc for LED 2

Flexible light strip length = 226mm
Standard Part Number = ASMT-Lx50

Notes:

1. All dimensions in millimeters (Inches).
2. Tolerances are $\pm 0.1\text{mm}$ [0.004 IN.] Unless otherwise specified.
3. Strip diameter $\phi 1.4\text{mm}$.

Part Numbering System for Other Available Options

ASMT - L x 50 - xxx x B

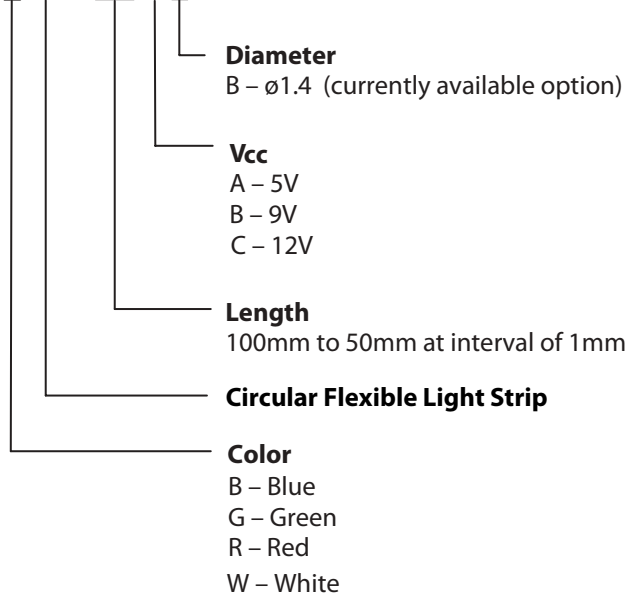

Recommended Connector

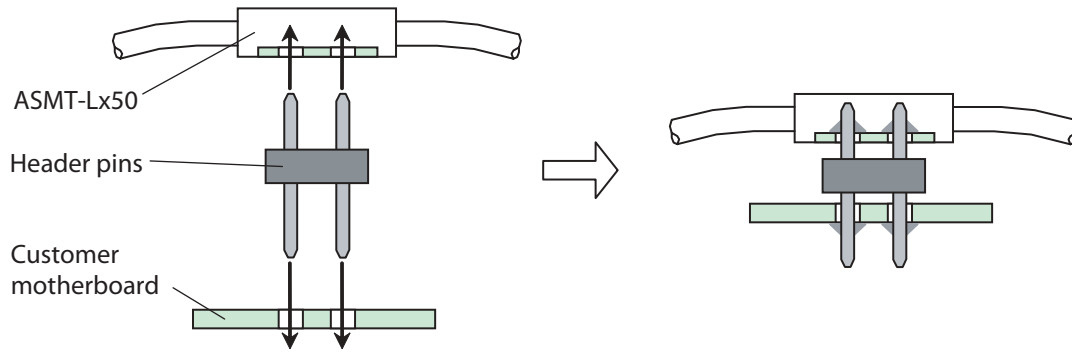

CAUTION: ASMT-Lx50 devices are Class 1 ESD sensitive. Please observe appropriate precautions during handling and processing. Refer to Avago Technologies Application Note AN-1142 for additional details.

Absolute Maximum Ratings at $T_A = 25^\circ\text{C}$

Parameter	ASMT-Lx50	Unit
DC Forward Current ^{[1] [2]}	30	mA
Power Dissipation ^{[2] [3]}	153	mW
Reverse Voltage ($I_R = 100 \text{ A}$) ^[2]	5	V
LED Junction Temperature	110	$^\circ\text{C}$
Operating Temperature Range	-30 to 60	$^\circ\text{C}$
Storage Temperature Range	-30 to 60	$^\circ\text{C}$
Manual Soldering Temperature	350 $^\circ\text{C}$ for 3 sec max	

Note:

1. Derate linearly as shown in Figure 4.
2. For each individual LED + resistor string.
3. $V_{cc} \text{ max} = 5.1\text{V}$.

Electrical Characteristics at $T_A = 25^\circ\text{C}$

Part Number	Voltage V_{cc} (Volts) ^[1]			LED Forward Current ^[1]
	Minimum	Typical	Maximum	I_F (mA) @ $V_{cc} = 5.0\text{V}$
ASMT-Lx50	4.9	5.0	5.1	20

Note:

1. For each individual LED + resistor string.
2. Resistor value is determined by forward voltage of LED.

Optical Characteristics at T_A = 25°C

Part Number	Luminous Intensity, I _v ^{[1][2]} (mcd) @ 20mA		Peak Wavelength, λ _{peak} ^[1] (nm)	Color, Dominant Wavelength λ _d ^{[1][3]} (nm)		Luminous Incidence ^[5] E _v (lm/m ²)
	Min.	Max.	Typ.	Min.	Max.	Typ.
ASMT-LB50	71.5	180.0	468	465	475	30.0
ASMT-LG50	180.0	450.0	520.0	515.0	535.0	130.0
ASMT-LR50	112.5	285.0	637.0	615.0	630.0	30.0

Part Number	Luminous Intensity, I _v ^{[1][2]} (mcd) @20mA		Typical Chromaticity Coordinates ^{[1][4]}		Luminous Incidence ^[5] E _v (lm/m ²)
	Min.	Max.	X	Y	Typ.
ASMT-LW50	1000	1600	0.31	0.31	230.0

Notes:

1. For individual LED light source only.
2. The luminous intensity I_v is measured at the peak of the spatial radiation pattern which may not be aligned with the mechanical axis of the LED package. Refer to I_v bin table for binning structure and tolerance.
3. The dominant wavelength, λ_d, is derived from the CIE 1931 Chromaticity Diagram and represents the perceived color of the device. Refer to color bin limit tables for binning structure and tolerance.
4. The chromaticity coordinates are derived from the CIE 1931 Chromaticity Diagram and represent the perceived color of the device. Refer to color bin limit tables for binning structure and tolerance.
5. Measurement done at the center of the elastomer light stripe away from the LED light sources.

Light Intensity (I_v) Bin Limits^{[1][2]}

Blue

Bin ID	Intensity (mcd)	
	Minimum	Maximum
Q	71.50	112.50
R	112.50	180.00

Tolerance: ±15%

Green

Bin ID	Intensity (mcd)	
	Minimum	Maximum
S	180.0	285.0
T	285.0	450.0

Tolerance: ±15%

Red

Bin ID	Intensity (mcd)	
	Minimum	Maximum
R	112.5	180.0
S	180.0	285.0

Tolerance: ±15%

White

Bin ID	Intensity (mcd)	
	Minimum	Maximum
W1	1000	1200
W2	1200	1400
W3	1400	1600

Tolerance: ±15%

Notes:

1. Bin categories are established for classification of products. Products may not be available in all categories. Please contact your Avago representative for information on current available bins.
2. For individual LED light source only.

Color Bin Limits ^[1] ^[2]

Blue

Bin ID	Dom. Wavelength (nm)	
	Minimum	Maximum
B	465.0	470.0
C	470.0	475.0

Tolerance: ±1.0nm

Green

Bin ID	Dom. Wavelength (nm)	
	Minimum	Maximum
A	515.0	520.0
B	520.0	525.0
C	525.0	530.0
D	530.0	535.0

Tolerance: ±1.0nm

Red

Bin ID	Dom. Wavelength (mcd)	
	Minimum	Maximum
-	615	630

Tolerance: ±1.0nm

White

Rank	Chromaticity Coordinates				
	C11	X	0.290	0.297	0.297
	Y	0.306	0.316	0.283	0.274
C12	X	0.297	0.303	0.303	0.297
	Y	0.316	0.326	0.293	0.283
C13	X	0.303	0.310	0.310	0.303
	Y	0.326	0.336	0.303	0.293
C21	X	0.290	0.297	0.297	0.290
	Y	0.274	0.283	0.251	0.241
C22	X	0.297	0.303	0.303	0.297
	Y	0.283	0.293	0.261	0.251
C23	X	0.303	0.310	0.310	0.297
	Y	0.293	0.303	0.271	0.251
D11	X	0.310	0.320	0.320	0.310
	Y	0.336	0.350	0.318	0.303
D12	X	0.320	0.330	0.330	0.320
	Y	0.350	0.365	0.333	0.318
D21	X	0.310	0.320	0.320	0.310
	Y	0.303	0.318	0.285	0.271
D22	X	0.320	0.330	0.330	0.320
	Y	0.318	0.333	0.300	0.285

Tolerance of each bin limit = ± 0.02

Notes:

1. Bin categories are established for classification of products. Products may not be available in all categories. Please contact your Avago representative for information on current available bins.
2. For individual LED light source only.

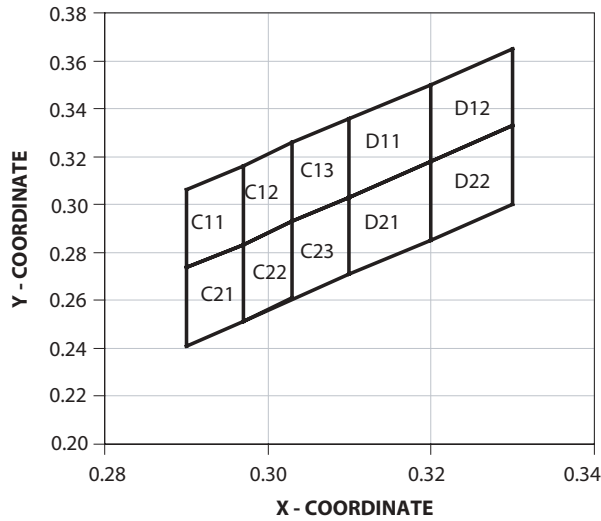

Figure 1. White binning in CIE 1931 Chromaticity Diagram.

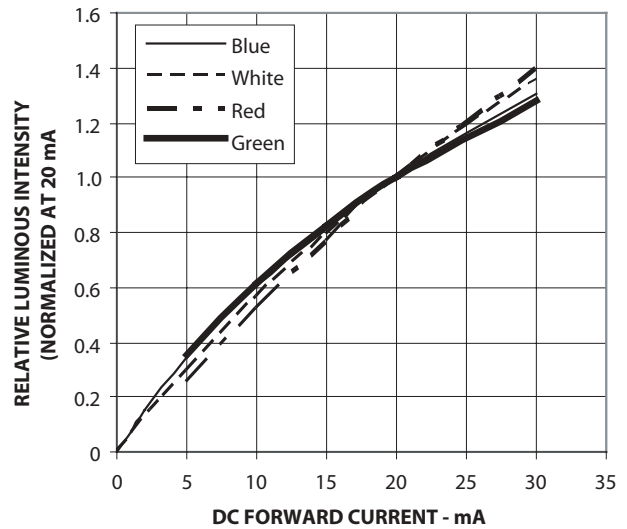

Figure 2. Relative luminous intensity vs. forward current for LED light sources only.

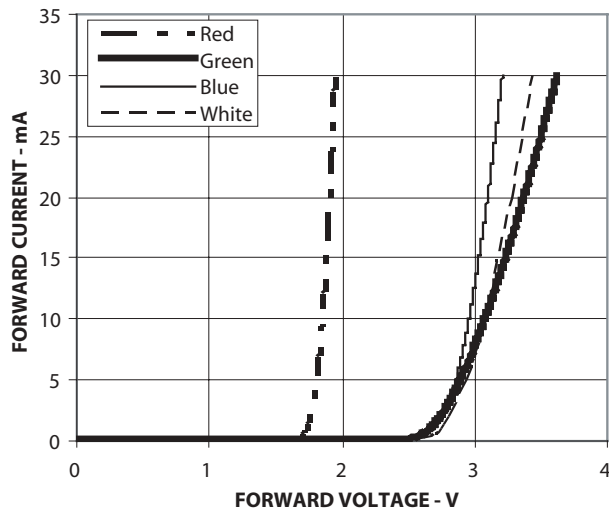

Figure 3. Forward voltage vs. forward current for LED light sources only.

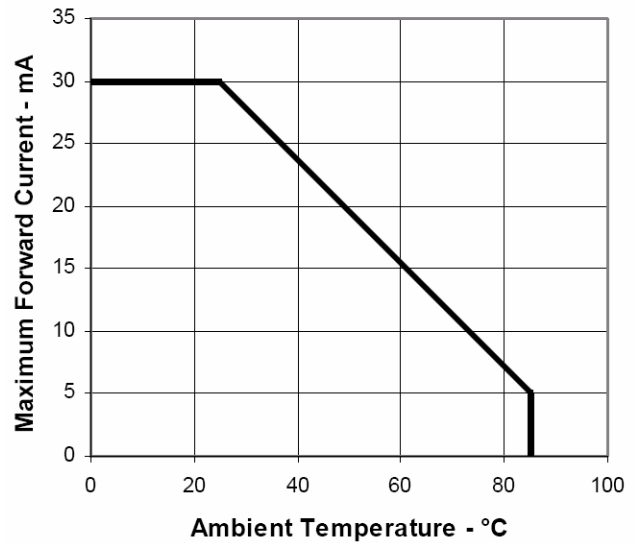

Figure 4. Maximum forward current vs. ambient temperature

Handling Caution

1. Bending radius of the lightpipe shall always be larger than 10 times of the lightpipe diameter to avoid impact to its appearance and performance.

For product information and a complete list of distributors, please go to our web site: www.avagotech.com

Avago, Avago Technologies, and the A logo are trademarks of Avago Technologies, Limited in the United States and other countries. Data subject to change. Copyright © 2006 Avago Technologies Limited. All rights reserved. Obsoletes AV01-0430EN AV01-0649EN - November 13, 2006

