





# Millenium3



## Millenium 3 logic controllers



Type	Part number	Power supply	Inputs	Outputs	
<b>With display</b>					
	<b>CD12</b>	88970041	24 V $\text{---}$	8 digital (of which 4 are analogue)	4 x 8 A relays
		88970042	24 V $\text{---}$	8 digital (of which 4 are analogue)	4 solid state 0.5 A (of which 1 is PWM)
		88970043	100 $\rightarrow$ 240 V $\sim$	8 digital	4 x 8 A relays
		88970044	24 V $\sim$	8 digital	4 x 8 A relays
		88970045	12 V $\text{---}$	8 digital (of which 4 are analogue)	4 x 8 A relays
	<b>CD20</b>	88970051	24 V $\text{---}$	12 digital (of which 6 are analogue)	8 x 8 A relays
		88970052	24 V $\text{---}$	12 digital (of which 6 are analogue)	8 solid state 0.5 A (of which 4 are PWM)
		88970053	100 $\rightarrow$ 240 V $\sim$	12 digital	8 x 8 A relays
		88970054	24 V $\sim$	12 digital	8 x 8 A relays
		88970055	12 V $\text{---}$	12 digital (of which 6 are analogue)	8 x 8 A relays
<b>Without display</b>					
	<b>CB12</b>	88970021	24 V $\text{---}$	8 digital (of which 4 are analogue)	4 x 8 A relays
		88970023	100 $\rightarrow$ 240 V $\sim$	8 digital	4 x 8 A relays
		88970024	24 V $\sim$	8 digital	4 x 8 A relays
		88970840 <b>NEW</b>	12 V $\text{---}$	8 digital (of which 4 are analogue)	4 solid state 0.5 A (of which 1 is PWM)
	<b>CB20</b>	88970031	24 V $\text{---}$	12 digital (of which 6 are analogue)	8 x 8 A relays
		88970033	100 $\rightarrow$ 240 V $\sim$	12 digital	8 x 8 A relays
		88970034	24 V $\sim$	12 digital	8 x 8 A relays



■ Ergonomic display



■ Optimum memory capacity

Millenium 3 logic controllers operate with the following software:



### ■ M3 SOFT









Multilingual programming software (CD-ROM) including a library of specific functions.  
Part no.: 88970111

### ■ M3 ALARM

Alarm management software (CD-ROM)  
Part no.: 88970116  
This software is used alongside the M3MOD communication interface (part no.: 88970117).

For all details of hardware adaptation, see pages 64-65.

# “Compact” range selection guide

Modem communication solutions			Modular power supplies <sup>(1)</sup>					Starter kits and demo case
M3MOD	STN	GSM	12 V DC - 24 W	24 V DC - 7.5 W	24 V DC - 15 W	24 V DC - 30 W	24 V DC - 60 W	
								
88970117	88970118	88970119	88950306	88950303	88950304	88950307	88950302	Standard
<input checked="" type="checkbox"/>	<input type="checkbox"/>	<input type="checkbox"/>		<input checked="" type="checkbox"/>	<input checked="" type="checkbox"/>	<input checked="" type="checkbox"/>	<input checked="" type="checkbox"/>	88970080
<input checked="" type="checkbox"/>	<input type="checkbox"/>	<input type="checkbox"/>		<input checked="" type="checkbox"/>	<input checked="" type="checkbox"/>	<input checked="" type="checkbox"/>	<input checked="" type="checkbox"/>	88970106 (case)
<input checked="" type="checkbox"/>	<input type="checkbox"/>	<input type="checkbox"/>						88970081
<input checked="" type="checkbox"/>	<input type="checkbox"/>	<input type="checkbox"/>	<input checked="" type="checkbox"/>					
<input checked="" type="checkbox"/>	<input type="checkbox"/>	<input type="checkbox"/>		<input checked="" type="checkbox"/>	<input checked="" type="checkbox"/>	<input checked="" type="checkbox"/>	<input checked="" type="checkbox"/>	88970082
<input checked="" type="checkbox"/>	<input type="checkbox"/>	<input type="checkbox"/>		<input checked="" type="checkbox"/>	<input checked="" type="checkbox"/>	<input checked="" type="checkbox"/>	<input checked="" type="checkbox"/>	88970083
<input checked="" type="checkbox"/>	<input type="checkbox"/>	<input type="checkbox"/>	<input checked="" type="checkbox"/>					
<input checked="" type="checkbox"/>	<input type="checkbox"/>	<input type="checkbox"/>		<input checked="" type="checkbox"/>	<input checked="" type="checkbox"/>	<input checked="" type="checkbox"/>	<input checked="" type="checkbox"/>	
<input checked="" type="checkbox"/>	<input type="checkbox"/>	<input type="checkbox"/>						
<input checked="" type="checkbox"/>	<input type="checkbox"/>	<input type="checkbox"/>	<input checked="" type="checkbox"/>					
<input checked="" type="checkbox"/>	<input type="checkbox"/>	<input type="checkbox"/>		<input checked="" type="checkbox"/>	<input checked="" type="checkbox"/>	<input checked="" type="checkbox"/>	<input checked="" type="checkbox"/>	
<input checked="" type="checkbox"/>	<input type="checkbox"/>	<input type="checkbox"/>						

Compatible  
 Mounted with the M3MOD:  
 - STN modem,  
 - or GSM modem

<sup>(1)</sup> Find the whole “Power Supplies” offer on pages 58-59.



#### The 4 starter kits each contain:

- 1 CD12 or CD20 logic controller + 1 USB link cable + 1 M3 SOFT programming software application (CD-ROM) including a library of specific functions.  
Part no.: 88970080 / 88970081 / 88970082 / 88970083



#### The demonstration case contains:

- 1 CD12 logic controller + 1 USB link cable + 1 M3 SOFT programming software application (CD-ROM) including the library of specific functions + 1 voltage adaptor + 1 I/O simulation card.  
Part no.: 88970106

# Millenium 3 Standard

## → "Compact" range with display

- Budget solution with display
- Memory: 120 lines in LADDER language and up to 350 "typical" blocks in FBD language
- LCD with 4 lines of 18 characters and configurable backlighting
- Selective parameter setting: You can choose the parameters that can be adjusted on the front panel
- Analogue inputs 0-10 V<sub>DC</sub> or 0-20 mA/Pt 100 with converters (see page 50)



CD12



CD20

### Part numbers

Type	Input	Output	Supply	Code
CD12	8 digital (including 4 analogue)	4 relays 8 A	24 V $\overline{\text{DC}}$	88970041
	8 digital (including 4 analogue)	4 solid state 0.5 A (including 1 PWM)	24 V $\overline{\text{DC}}$	88970042
	8 digital	4 relays 8 A	100 → 240 V $\sim$	88970043
	8 digital	4 relays 8 A	24 V $\sim$	88970044
	8 digital (including 4 analogue)	4 relays 8 A	12 V $\overline{\text{DC}}$	88970045
CD20	12 digital (including 6 analogue)	8 relays 8 A	24 V $\overline{\text{DC}}$	88970051
	12 digital (including 6 analogue)	8 solid state 0.5 A (including 4 PWM)	24 V $\overline{\text{DC}}$	88970052
	12 digital	8 relays 8 A	100 → 240 V $\sim$	88970053
	12 digital	8 relays 8 A	24 V $\sim$	88970054
	12 digital (including 6 analogue)	8 relays 8 A	12 V $\overline{\text{DC}}$	88970055

### Accessories

Type	Description	Code
M3 SOFT	Multilingual programming software containing specific library functions (CD-ROM)	88970111
PA	EEPROM memory cartridge	88970108
	3 m serial link cable: PC → Millenium 3	88970102
	3 m USB link cable: PC → Millenium 3	88970109
	Millenium 3 → Bluetooth interface (class A 10 m)	88970104

### Starter kits (see page 27 for details)

Type	Input	Output	Supply	Code
Kit 12	8 digital (including 4 analogue)	4 relays	24 V $\overline{\text{DC}}$	88970080
	8 digital	4 relays	100 → 240 V $\sim$	88970081
Kit 20	12 digital (including 6 analogue)	8 relays	24 V $\overline{\text{DC}}$	88970082
	12 digital	8 relays	100 → 240 V $\sim$	88970083

### Dimensions (mm)

CD12

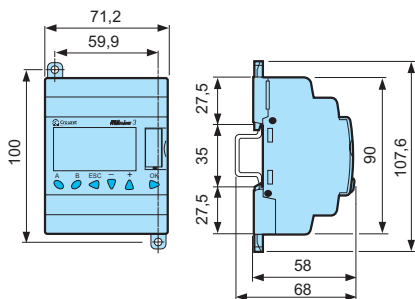

CD20

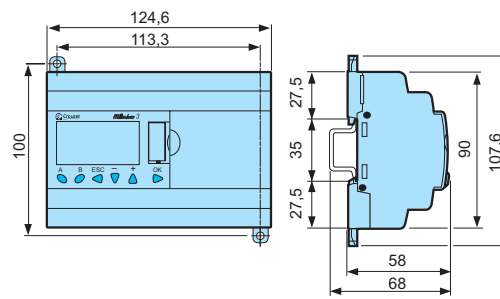

### Input / Output Connections

See Page 40-43 for details or to find instruction sheets visit: [www.millenium3.crouzet.com](http://www.millenium3.crouzet.com) in "Download"

For adapted products, see page page 64-65

## → "Compact" range without display

- Simply a control system solution inside a modular casing
- Memory: 120 lines in LADDER language and up to 350 "typical" blocks in FBD language
- No display or parameter-setting buttons to avoid tampering by unauthorised users
- Analogue inputs 0-10 V $\overline{\text{DC}}$  or 0-20 mA/Pt 100 with converters (see page 50)



CB12



CB20

### Part numbers

Type	Input	Output	Supply	Code
CB12	8 digital (including 4 analogue)	4 relays 8 A	24 V $\overline{\text{DC}}$	88970021
	8 digital	4 relays 8 A	100 → 240 V $\sim$	88970023
	8 digital	4 relays 8 A	24 V $\sim$	88970024
	8 digital (including 4 analogue)	4 solid state 0.5 A (including 1 PWM)	12 V $\overline{\text{DC}}$	88970840
CB20	12 digital (including 6 analogue)	8 relays 8 A	24 V $\overline{\text{DC}}$	88970031
	12 digital	8 relays 8 A	100 → 240 V $\sim$	88970033
	12 digital	8 relays 8 A	24 V $\sim$	88970034

### Accessories

Type	Description	Code
M3 SOFT	Multilingual programming software containing specific library functions (CD-ROM)	88970111
PA	EEPROM memory cartridge	88970108
	3 m serial link cable: PC → Millenium 3	88970102
	3 m USB link cable: PC → Millenium 3	88970109
	Millenium 3 → Bluetooth interface (class A 10 m)	88970104

### Dimensions (mm)

CB12

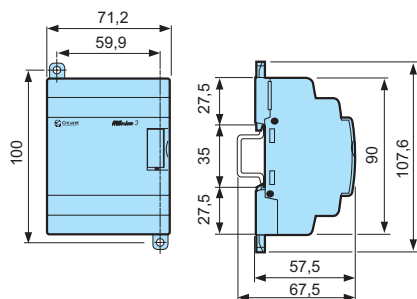

CB20

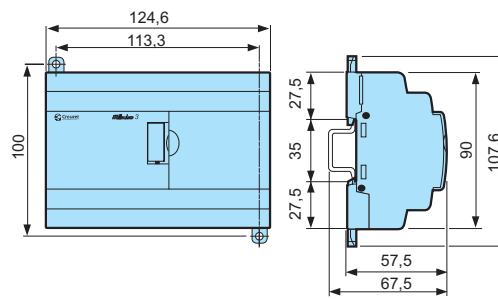

### Input / Output Connections

See Page 40-43 for details or to find instruction sheets visit: [www.millenium3.crouzet.com](http://www.millenium3.crouzet.com) in "Download"

For adapted products, see page page 64-65

# Millenium3



## Millenium 3 logic controllers



Type	Part number	Power supply	Inputs	Outputs	
	With XD10/ XD26 display	Without display XB10/XB26			
	88970141	88970131 <b>NEW</b>	24 V $\text{---}$	6 digital (of which 4 are analogue)	4 x 8 A relays
	88970142	88970132 <b>NEW</b>	24 V $\text{---}$	6 digital (of which 4 are analogue)	4 solid state 0.5 A (of which 1 is PWM)
	88970143	88970133 <b>NEW</b>	100 $\rightarrow$ 240 V $\sim$	6 digital	4 x 8 A relays
	88970144	88970134 <b>NEW</b>	24 V $\sim$	6 digital	4 x 8 A relays
	88970161	88970151 <b>NEW</b>	24 V $\text{---}$	16 digital (of which 6 are analogue)	10 relays, of which 8 are 8 A and 2 are 5 A
	88970162	88970152 <b>NEW</b>	24 V $\text{---}$	16 digital (of which 6 are analogue)	10 solid state 0.5 A (of which 4 are PWM)
	88970163	88970153 <b>NEW</b>	100 $\rightarrow$ 240 V $\sim$	16 digital	10 relays, of which 8 are 8 A and 2 are 5 A
	88970164	88970154 <b>NEW</b>	24 V $\sim$	16 digital	10 relays, of which 8 are 8 A and 2 are 5 A
	88970165	88970155 <b>NEW</b>	12 V $\text{---}$	16 digital (of which 6 are analogue)	10 relays, of which 8 are 8 A and 2 are 5 A
	88970814 <b>NEW</b>	-	12 V $\text{---}$	16 digital (of which 6 are analogue)	10 solid state 0.5 A (of which 4 are PWM)

## Extensions "Sandwich"

Type	Part number	Power supply	Inputs	Outputs		
<b>TOR</b>						
	XE10	88970321	Via the 24 V $\text{---}$ controller	6 digital	4 x 5 A relays, 1 of which is a changeover relay	
		88970323	100 $\rightarrow$ 240 V $\sim$	6 digital	4 x 5 A relays, 1 of which is a changeover relay	
		88970324	24 V $\sim$	6 digital	4 x 5 A relays, 1 of which is a changeover relay	
<b>Communication</b>						
	XN05	88970270	Via the 24 V $\text{---}$ controller	Modbus TCP Ethernet protocol	Read: 8 - Read/Write: 8 Clock: 4 - Status: 1	
		XN03	88970250	Via the 24 V $\text{---}$ controller	Modbus RS-485 (slave)	Read: 8 - Read/Write: 8 Clock: 4 - Status: 1
		XN06	88972250 <b>NEW</b>	Via the 24 V $\text{---}$ controller	Modbus RS-485 (slave)	Read: 8 - Read/Write: 8 Clock: 4 - Status: 1



Millenium 3 logic controllers operate with the following software:

### ■ M3 SOFT

Multilingual programming software (CD-ROM) including the library of specific functions.

Part no.: 88970111

### ■ M3 ALARM

Alarm management software (CD-ROM)

Part no.: 88970116

This software is used alongside the M3MOD communication interface (part no.: 88970117).

For all details of hardware adaptation, see pages 64-65.



# “Expandable” range selection guide

Modem communication solutions			Modular power supplies <sup>(1)</sup>					Starter kits
M3MOD	STN	GSM	12 V DC - 24 W	24 V DC - 7.5 W	24 V DC - 15 W	24 V DC - 30 W	24 V DC - 60 W	
88970117	88970118	88970119	88950306 <b>NEW</b>	88950303 <b>NEW</b>	88950304 <b>NEW</b>	88950307 <b>NEW</b>	88950302	Expandable
<input checked="" type="checkbox"/>	<input type="checkbox"/>	<input type="checkbox"/>		<input checked="" type="checkbox"/>	<input checked="" type="checkbox"/>	<input checked="" type="checkbox"/>	<input checked="" type="checkbox"/>	
<input checked="" type="checkbox"/>	<input type="checkbox"/>	<input type="checkbox"/>		<input checked="" type="checkbox"/>	<input checked="" type="checkbox"/>	<input checked="" type="checkbox"/>	<input checked="" type="checkbox"/>	
<input checked="" type="checkbox"/>	<input type="checkbox"/>	<input type="checkbox"/>		<input checked="" type="checkbox"/>	<input checked="" type="checkbox"/>	<input checked="" type="checkbox"/>	<input checked="" type="checkbox"/>	
<input checked="" type="checkbox"/>	<input type="checkbox"/>	<input type="checkbox"/>		<input checked="" type="checkbox"/>	<input checked="" type="checkbox"/>	<input checked="" type="checkbox"/>	<input checked="" type="checkbox"/>	88970084
<input checked="" type="checkbox"/>	<input type="checkbox"/>	<input type="checkbox"/>		<input checked="" type="checkbox"/>	<input checked="" type="checkbox"/>	<input checked="" type="checkbox"/>	<input checked="" type="checkbox"/>	88970085
<input checked="" type="checkbox"/>	<input type="checkbox"/>	<input type="checkbox"/>	<input checked="" type="checkbox"/>					
<input checked="" type="checkbox"/>	<input type="checkbox"/>	<input type="checkbox"/>	<input checked="" type="checkbox"/>					

- Compatible
- Mounted with the M3MOD:
  - STN modem,
  - or GSM modem

<sup>(1)</sup> Find the whole “Power Supplies” offer on pages 58-59.

Termination extensions					
Type	Part number	Power supply	Inputs	Outputs	
<b>Digital</b>					
	<b>XR06</b>	88970211	Via the 24 V $\overline{\text{DC}}$ controller	4 digital	2 x 8 A relays
		88970213	Via the 100 $\rightarrow$ 240 V $\sim$ controller	4 digital	2 x 8 A relays
		88970214	Via the 24 V $\sim$ controller	4 digital	2 x 8 A relays
		88970215	Via the 12 V $\overline{\text{DC}}$ controller	4 digital	2 x 8 A relays
	<b>XR10</b>	88970221	Via the 24 V $\overline{\text{DC}}$ controller	6 digital	4 x 8 A relays
		88970223	Via the 100 $\rightarrow$ 240 V $\sim$ controller	6 digital	4 x 8 A relays
		88970224	Via the 24 V $\sim$ controller	6 digital	4 x 8 A relays
		88970225	Via the 12 V $\overline{\text{DC}}$ controller	6 digital	4 x 8 A relays
	<b>XR14</b>	88970231	Via the 24 V $\overline{\text{DC}}$ controller	8 digital	6 relays, of which 4 are 8 A and 2 are 5 A
		88970233	Via the 100 $\rightarrow$ 240 V $\sim$ controller	8 digital	6 relays, of which 4 are 8 A and 2 are 5 A
		88970234	Via the 24 V $\sim$ controller	8 digital	6 relays, of which 4 are 8 A and 2 are 5 A
		88970235	Via the 12 V $\overline{\text{DC}}$ controller	8 digital	6 relays, of which 4 are 8 A and 2 are 5 A
<b>Analogue</b>					
	<b>XA04</b>	88970241	Via the 24 V $\overline{\text{DC}}$ controller	1 analogue (0-10 V/0-20 mA), 1 analogue (0-10 V/0-20 mA/Pt100)	2 analogue (0-10 V)/PWM



**The 2 starter kits each contain:**

- 1 XD26 logic controller + 1 USB link cable +
  - 1 M3 SOFT programming software application (CD-ROM) including a library of specific functions.
- Part no.: 88970084 / 88970085

# Millenium 3 Standard

## → "Expandable" range with display

- "High-performance" expandable solution with display
- Extended memory: 120 lines in LADDER language and up to 700 "typical" blocks in FBD language
- LCD with 4 lines of 18 characters and configurable backlighting
- Selective parameter setting: You can choose the parameters that can be adjusted on the front panel
- Analogue inputs 0-10 V  $\overline{\text{---}}$  or 0-20 mA/Pt 100 with converters (see page 50)
- Open to XN network communication extensions and digital I/O or analogue extensions



XD10



XD26

### Part numbers

Type	Input	Output	Supply	Code
XD10	6 digital (including 4 analogue)	4 relays 8 A	24 V $\overline{\text{---}}$	88970141
	6 digital (including 4 analogue)	4 solid state 0.5 A (including 1 PWM)	24 V $\overline{\text{---}}$	88970142
	6 digital	4 relays 8 A	100 $\rightarrow$ 240 V $\sim$	88970143
	6 digital	4 relays 8 A	24 V $\sim$	88970144
XD26	16 digital (including 6 analogue)	10 relays (8 x 8 A relay and 2 x 5 A relay)	24 V $\overline{\text{---}}$	88970161
	16 digital (including 6 analogue)	10 solid state 0.5 A (including 4 PWM)	24 V $\overline{\text{---}}$	88970162
	16 digital	10 relays (8 x 8 A relay and 2 x 5 A relay)	100 $\rightarrow$ 240 V $\sim$	88970163
	16 digital	10 relays (8 x 8 A relay and 2 x 5 A relay)	24 V $\sim$	88970164
	16 digital (including 6 analogue)	10 relays (8 x 8 A relay and 2 x 5 A relay)	12 V $\overline{\text{---}}$	88970165
	16 digital (including 6 analogue)	10 solid state 0.5 A (including 4 PWM)	12 V $\overline{\text{---}}$	88970814

### Accessories

Type	Description	Code
M3 SOFT	Multilingual programming software containing specific library functions (CD-ROM)	88970111
PA	EEPROM memory cartridge	88970108
	3 m serial link cable: PC $\rightarrow$ Millenium 3	88970102
	3 m USB link cable: PC $\rightarrow$ Millenium 3	88970109
	Millenium 3 $\rightarrow$ Bluetooth interface (class A 10 m)	88970104

### Starter kits (see page 31 for details)

Type	Input	Output	Supply	Code
Kit 26	16 digital (including 6 analogue)	10 relays (8 x 8 A relay and 2 x 5 A relay)	24 V $\overline{\text{---}}$	88970084
	16 digital	10 relays (8 x 8 A relay and 2 x 5 A relay)	100 $\rightarrow$ 240 V $\sim$	88970085

### Dimensions (mm)

XD10

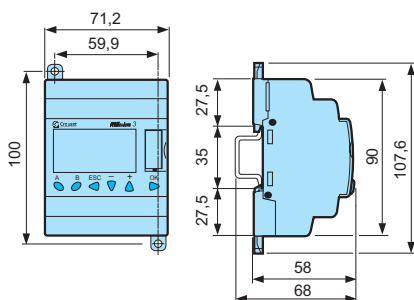

XD26

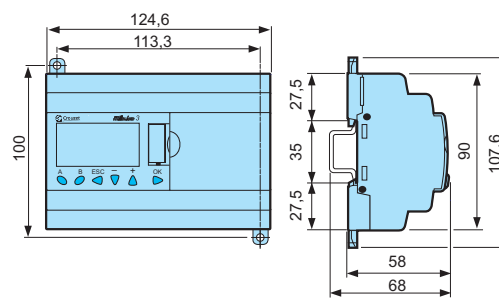

### Input / Output Connections

See Page 40-43 for details or to find instruction sheets visit: [www.millenium3.crouzet.com](http://www.millenium3.crouzet.com) in "Download"

For adapted products, see page page 64-65

# Millenium 3 Standard

## → "Expandable" range without display

- "High-performance" expandable solution without display
- Extended memory: 120 lines in LADDER language and up to 700 "typical" blocks in FBD language
- No display or parameter-setting buttons to avoid tampering by unauthorised users
- Analogue inputs 0-10 V  $\overline{\text{DC}}$  or 0-20 mA/Pt 100 with converters (see page 50)
- Open to XN network communication extensions and digital I/O or analogue extensions



XB10



XB26

### Part numbers

Type	Input	Output	Supply	Code
XB10	6 digital (including 4 analogue)	4 relays 8 A	24 V $\overline{\text{DC}}$	88970131*
	6 digital (including 4 analogue)	4 solid state 0.5 A (including 1 PWM)	24 V $\overline{\text{DC}}$	88970132
	6 digital	4 relays 8 A	100 → 240 V $\sim$	88970133*
	6 digital	4 relays 8 A	24 V $\sim$	88970134
XB26	16 digital (including 6 analogue)	10 relays (8 x 8 A relay and 2 x 5 A relay)	24 V $\overline{\text{DC}}$	88970151
	16 digital (including 6 analogue)	10 solid state 0.5 A (including 4 PWM)	24 V $\overline{\text{DC}}$	88970152
	16 digital	10 relays (8 x 8 A relay and 2 x 5 A relay)	100 → 240 V $\sim$	88970153
	16 digital	10 relays (8 x 8 A relay and 2 x 5 A relay)	24 V $\sim$	88970154
	16 digital (including 6 analogue)	10 relays (8 x 8 A relay and 2 x 5 A relay)	12 V $\overline{\text{DC}}$	88970155

\*Available 2<sup>nd</sup> quarter of 2008

### General characteristics

See page 22, except:

Certifications	UL, CSA
----------------	---------

### Accessories

Type	Description	Code
M3 SOFT	Multilingual programming software containing specific library functions (CD-ROM)	88970111
PA	EEPROM memory cartridge	88970108
PA	3 m serial link cable: PC → Millenium 3	88970102
PA	3 m USB link cable: PC → Millenium 3	88970109
PA	Millenium 3 → Bluetooth interface (class A 10 m)	88970104

### Dimensions (mm)

XB10

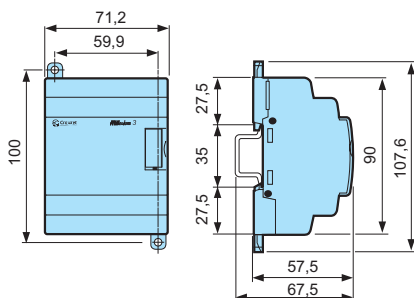

XB26

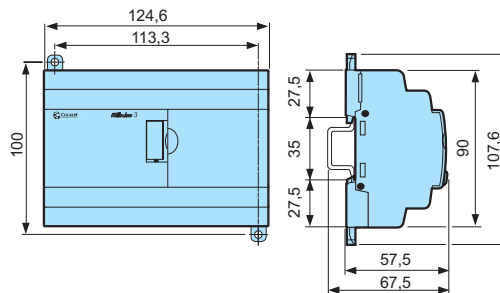

### Input / Output Connections

See Page 40-43 for details or to find instruction sheets visit: [www.millenium3.crouzet.com](http://www.millenium3.crouzet.com) in "Download"

For adapted products, see page 64-65



# Millenium 3 Standard

## → Sandwich communication extensions for XD10/XB10 & XD26/XB26

- Exchange of input/output state or of internal values via communication networks
- Power supply via the controller



### Part numbers

Type	Description	Supply	Code
XN03	Modbus RS-485 slave communication extension 4 words	Via the 24 V $\overline{\text{DC}}$ controller	88970250
XN06	Modbus RS-485 slave communication extension 8 words	Via the 24 V $\overline{\text{DC}}$ controller	88972250
XN05	Ethernet protocol TCP Modbus extension	Via the 24 V $\overline{\text{DC}}$ controller	88970270

### Characteristics of communication extensions

General characteristics	88970250 & 88972250	88970270
See page 22, except:		
Certifications	UL, CSA, GL (UL, CSA: 88972250)	UL, CSA GL pending
Earthing	Yes, refer to the quick reference guide supplied with the product	Yes, refer to the quick reference guide supplied with the product
Operating temperature	-20 → +55°C (+40°C in a non-ventilated enclosure) in accordance with IEC/EN 60068-2-1 and IEC/EN 60068-2-2	0 → +55°C (+40°C in a non-ventilated enclosure) in accordance with IEC 60068-2-1 and IEC 60068-2-2
Cable length	Maximum length of the network: 1000 m (9600 Baud max, AWG26)	Maximum length between 2 controllers: 100 m

Communication parameters	88970250 & 88972250	88970270
Type of link	2 or 4-wire; RTU or ASCII	-
Transmission rate (Bauds)	1200, 2400, 4800, 9600, 19200, 28800, 38400, 57600	-
Parity	None; even; odd	-
Addressing	1 → 247	Static or dynamic

Characteristics of exchanges	88970250	88972250	88970270
------------------------------	----------	----------	----------

### Programming with Ladder language

Image of smart relay I/O	4	4	-
Status	1	1	-

### Programming with FBD language

Read	4	8	8
Read/Write	4	8	8
Clock words	4	12	4
Status words	1	1	1

### Dimensions (mm)

XN03 - XN05 - XN06

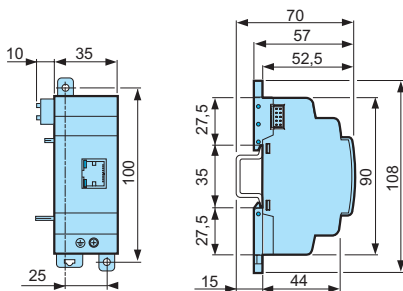

For adapted products, see page 64-65

## → Digital sandwich extension for XD10/XB10 and XD26/XB26

- Can be used to reach up to 50 inputs/outputs in conjunction with XR14 termination extensions
- Relay outputs one of which is a changeover relay



XE10

### Part numbers

Type	Input	Output	Supply	Code
XE10	6 digital	4 relays 5 A (1 of which is a changeover relay)	Via the 24 V $\square$ controller	88970321
	6 digital	4 relays 5 A (1 of which is a changeover relay)	100 → 240 V $\sim$	88970323
	6 digital	4 relays 5 A (1 of which is a changeover relay)	24 V $\sim$	88970324

### Dimensions (mm)

XE10

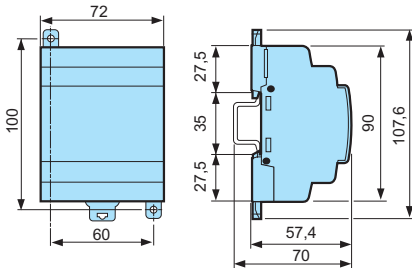

### Input / Output Connections

See Page 40-43 for details or to find instruction sheets visit: [www.millennium3.crouzet.com](http://www.millennium3.crouzet.com) in "Download"

For adapted products, see page page 64-65

# Millenium 3 Standard

## → Digital extension for XD10/XB10 and XD26/XB26

- Power supply via the controller at the same voltage as the inputs
- Number of inputs/outputs can be configured in accordance with your requirements



XR06

XR10

XR14

### Part numbers

Type	Input	Output	Supply	Code
XR06	4 digital	2 relays 8 A	Via the 24 V $\overline{\text{---}}$ controller	88970211
	4 digital	2 relays 8 A	Via the 100 $\rightarrow$ 240 V $\sim$ controller	88970213
	4 digital	2 relays 8 A	Via the 24 V $\sim$ controller	88970214
	4 digital	2 relays 8 A	Via the 12 V $\overline{\text{---}}$ controller	88970215
XR10	6 digital	4 relays 8 A	Via the 24 V $\overline{\text{---}}$ controller	88970221
	6 digital	4 relays 8 A	Via the 100 $\rightarrow$ 240 V $\sim$ controller	88970223
	6 digital	4 relays 8 A	Via the 24 V $\sim$ controller	88970224
	6 digital	4 relays 8 A	Via the 12 V $\overline{\text{---}}$ controller	88970225
XR14	8 digital	6 relays (4 x 8 A relay and 2 x 5 A relay)	Via the 24 V $\overline{\text{---}}$ controller	88970231
	8 digital	6 relays (4 x 8 A relay and 2 x 5 A relay)	Via the 100 $\rightarrow$ 240 V $\sim$ controller	88970233
	8 digital	6 relays (4 x 8 A relay and 2 x 5 A relay)	Via the 24 V $\sim$ controller	88970234
	8 digital	6 relays (4 x 8 A relay and 2 x 5 A relay)	Via the 12 V $\overline{\text{---}}$ controller	88970235

### Dimensions (mm)

XR06

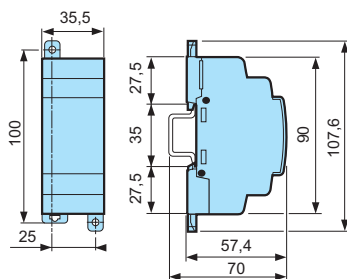

XR10 - XR14

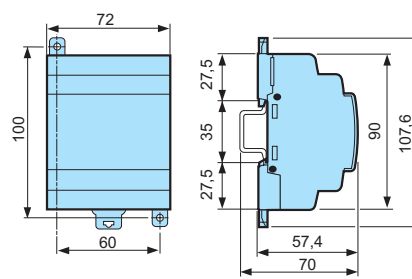

### Input / Output Connections

See Page 40-43 for details or to find instruction sheets visit: [www.millenium3.crouzet.com](http://www.millenium3.crouzet.com) in "Download"

## → Analogue extension for XD10/XB10 and XD26/XB26

- Direct connection of analogue 0-10 V or 0-20 mA or Pt 100 inputs (10 bits) can be configured using the M3 SOFT
- 2 analogue 0-10 V or PWM outputs (10 bits) can be configured using the M3 SOFT software
- Ramp can be parameterised for outputs used as 0-10 V outputs
- Power supply via the controller



XA04

### Part numbers

Type	Input	Output	Supply	Code
XA04	1 analogue (0-10 V / 0-20 mA), 1 analogue (0-10 V / 0-20 mA / Pt100)	2 analogue (0-10 V) / PWM	Via the 24 V $\overline{\text{---}}$ controller	88970241

For adapted products, see page page 64-65

## Characteristics of analogue extension 88970241

### General characteristics of analogue extension 88970241

#### See page 22, except:

Certifications	UL, CSA GL (pending)
Earthing	Yes, refer to the quick reference guide supplied with the product

### Analogue inputs

Inputs used as analogue inputs	0-10 V	0-20 mA	Pt 100
Input	IP and IQ	IP and IQ	IQ
Input range	0 → 10 V ---	0 → 20 mA	-25 → 125°C
Input impedance	≥ 18 kΩ	246 Ω	-
Maximum non destructive current/voltage	30 V	30 mA	-
Value of LSB	9.8 mV	20 μA	0.15°C
Input type	Common mode	Common mode	Pt 100 probe - IEC 751 - 3-wire
Resolution	10 bits	10 bits	10 bits
Conversion time	Module cycle time	Module cycle time	Module cycle time
Accuracy at 25°C	± 1%	± 1%	±1.5°C
Accuracy at 55°C	± 1%	± 1%	±1.5°C
Isolation between analogue channel and power supply	None	None	None
Longueur câble	10 m maximum, with shielded cable (sensor not isolated)	10 m maximum, with shielded cable (sensor not isolated)	10 m maximum, with shielded cable (sensor not isolated)
Protection against polarity inversions	Command ignored	Command ignored	Command ignored

### Analogue outputs

Range output	0 → 10 V
Input type	Resistive
Max. load	10 mA
Value of LSB	10 mV
Resolution	10 bits
Conversion time	Controller cycle time
Accuracy at 25°C	±1% of full scale
Accuracy at 55°C	±1% of full scale
Repeat accuracy at 55 °C	± 1%
Isolation between analogue channel and power supply	None
Cable length	10 metres maximum, with shielded cable (sensor not isolated)
Protection against polarity inversions	Yes

### PWM

Range output	V power supply
Max. load	≥ 1.2 kΩ (I ≤ 20 mA)
PWM cyclic ratio	1024 steps
Frequency	78 Hz, 312.5 Hz, 666.6 Hz, 1000 Hz, 1250 Hz, 1428 Hz, 1666 Hz, 2000 Hz
Accuracy	1% across the entire temperature range for PWM ratios from 5% to 95%
Built-in protections	Against overvoltages: Yes

## Dimensions (mm)

### XA04

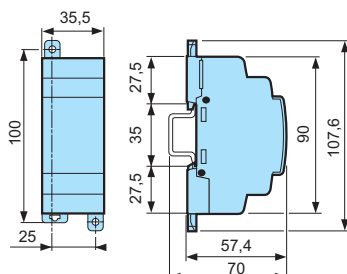

## Input / Output Connections

See Page 40-43 for details or to find instruction sheets visit: [www.millennium3.crouzet.com](http://www.millennium3.crouzet.com) in "Download"

For adapted products, see page page 64-65

# Millenium 3 Standard

## → Modem communication plug and play solutions

- For remote control of your application
- Automatic notification of alarms via SMS (GSM Modem) / email or on a PC with M3 ALARM software.
- Millenium 3 program can be downloaded, modified and sent
- Input and output states, as well as all program values, can be polled and controlled remotely
- 2 types of pre-configured ready-to-use modem:
  - STN modem for wired transmission networks
  - GSM modem for wireless communication



M3MOD



STN



GSM

### Part numbers

Type	Description	Supply	Code
M3MOD	Modem communication interface	12-24 V ---	88970117
STN	STN modem	12-24 V ---	88970118
GSM	GSM modem 850/900/1800/1900 MHz	12-24 V ---	88970119

### Accessories

Type	Description	Code
PA	1.80 m serial link cable: DB9/DB9	88970123
M3 ALARM	Alarm management software (CD-ROM)	88970116

### Characteristics of the communication Modem system

General characteristics of the modem communication	88970117	88970118	88970119
--	----------	----------	----------

#### See page 22, except:

Certifications	UL, CSA	UL, CSA	UL, CSA, CE, FCC, IC, PTCRB, R&TTE
----------------	---------	---------	------------------------------------

Power supply	88970117	88970118	88970119
--------------	----------	----------	----------

Nominal voltage (V)	12 → 24 V ---	12 → 24 V ---	12 → 24 V ---
Operating limits	-13% / + 20% or 10 → 28.8 V ---	-13% / + 5% or 10 → 30 V ---	-54% / + 33% or 5.5 → 32 V ---
Ripple	5% max.	-	-
Nominal current under 12 V DC	30 mA	140 mA	165 mA
Nominal current under 24 V DC	30 mA	70 mA	87 mA
Peak current on energisation	550 mA	9600 mA	2100 mA at 5.5 V
Max. absorbed power	1.1 W	-	2.1 W
Immunity from micro power cuts	1 ms, repetition 20 times	No	-
Protection against polarity inversions	Yes	-	No
Fuse protection	1 A fuse	-	With fuse 2.5 A

### Characteristics of the "COM-M3" link with the controller

Type of connector	Specific Millenium
Type of link	Specific Millenium communication protocol
Compatibility	Only with Millenium controllers version ≥ V2.1
Isolation of "Com-M3" connector from the "Com-M" connector	Via optocoupler ~ 1780 V
Isolation of "Com-M3" connector from the ± supply terminals	Via optocoupler ~ 1780 V

### Characteristics of the "COM-M3" link with the modem

Type of connector	Specific Millenium
Type of link with Modem connector cable	RS 232 serial (supplied with the communication interface)
Compatibility	Only with Millenium controllers version ≥ V2.1
Analogue RTC modem compatibility	AT commands
GSM modem compatibility	AT commands
Isolation of "Com-M" connector from the Modem	Via link cable to Modem (supplied)
Isolation of "Com-M" connector from the ± supply terminals	Via link cable to Modem (supplied)